



Dream Convertibles®

# SA-AGS-QS QUEEN SIZE

## ASSEMBLY INSTRUCTIONS

U.S. PATENT NUMBER D719,754S

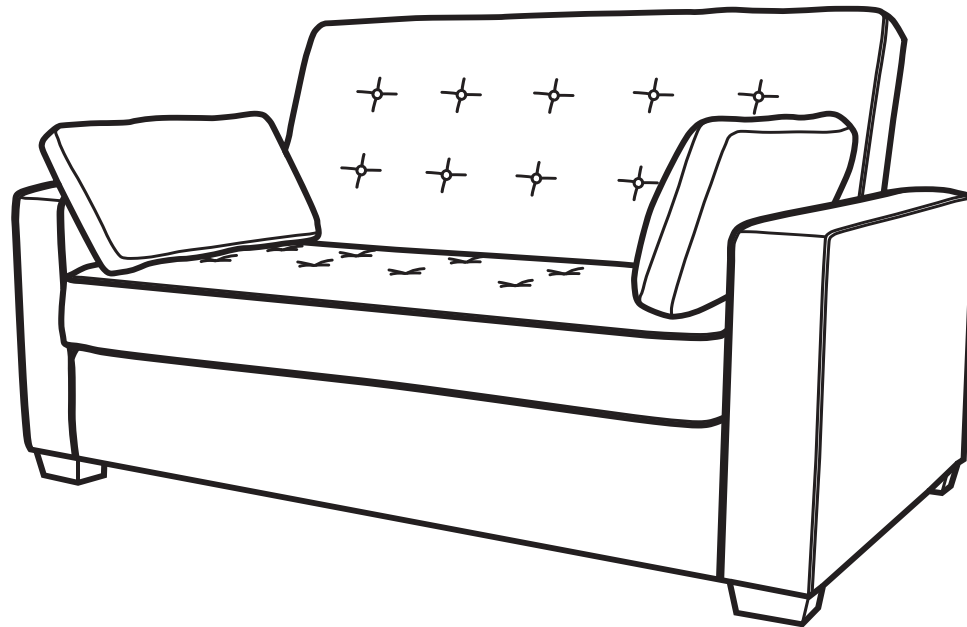

DO NOT RETURN PRODUCT TO THE STORE

individual stores do not stock parts.

If a part is missing or damaged, call our toll - free customer service line.

**Need parts or assistance?**

Please call :

**866-626-7826**

For prompt, reliable service; please have your assembly manual ready.

### WARNING

- This product has been designed for seating three (3) average adults. To prevent injury and damage to this unit, PROHIBIT jumping on it.
- This product is designed for home use and not intended for commercial use.
- Children under the age of 5, small infants and babies should not sleep alone on this product for safety reasons.
- Recommended # of people needed for handling: 2 (however it is always better to have an extra hand.)
- THIS INSTRUCTION BOOKLET CONTAINS **IMPORTANT** SAFETY INFORMATION. PLEASE READ AND KEEP FOR FUTURE REFERENCE.

---

# PARTS

---

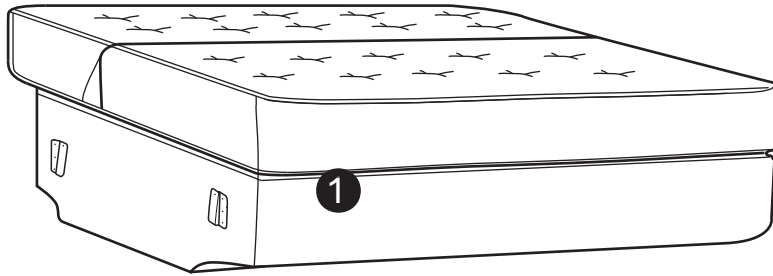

Sofa Body  
QTY:1

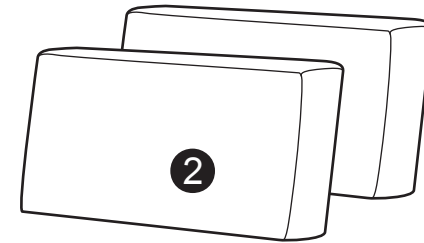

Pillow  
QTY: 2

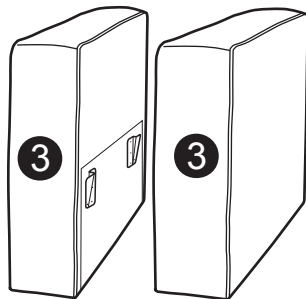

Arm  
QTY:1 Pair



Leg  
QTY:4

---

# HARDWARE



A

Allen Key  
M5 x 30mm x 80MM  
QTY : 1 PC

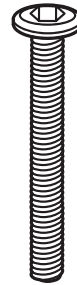

B

Bolt  
M8 x 50mm  
QTY : 4 PCS



C

Washer  
M8 x 24mm  
QTY : 4 PCS

---

Step 1 :

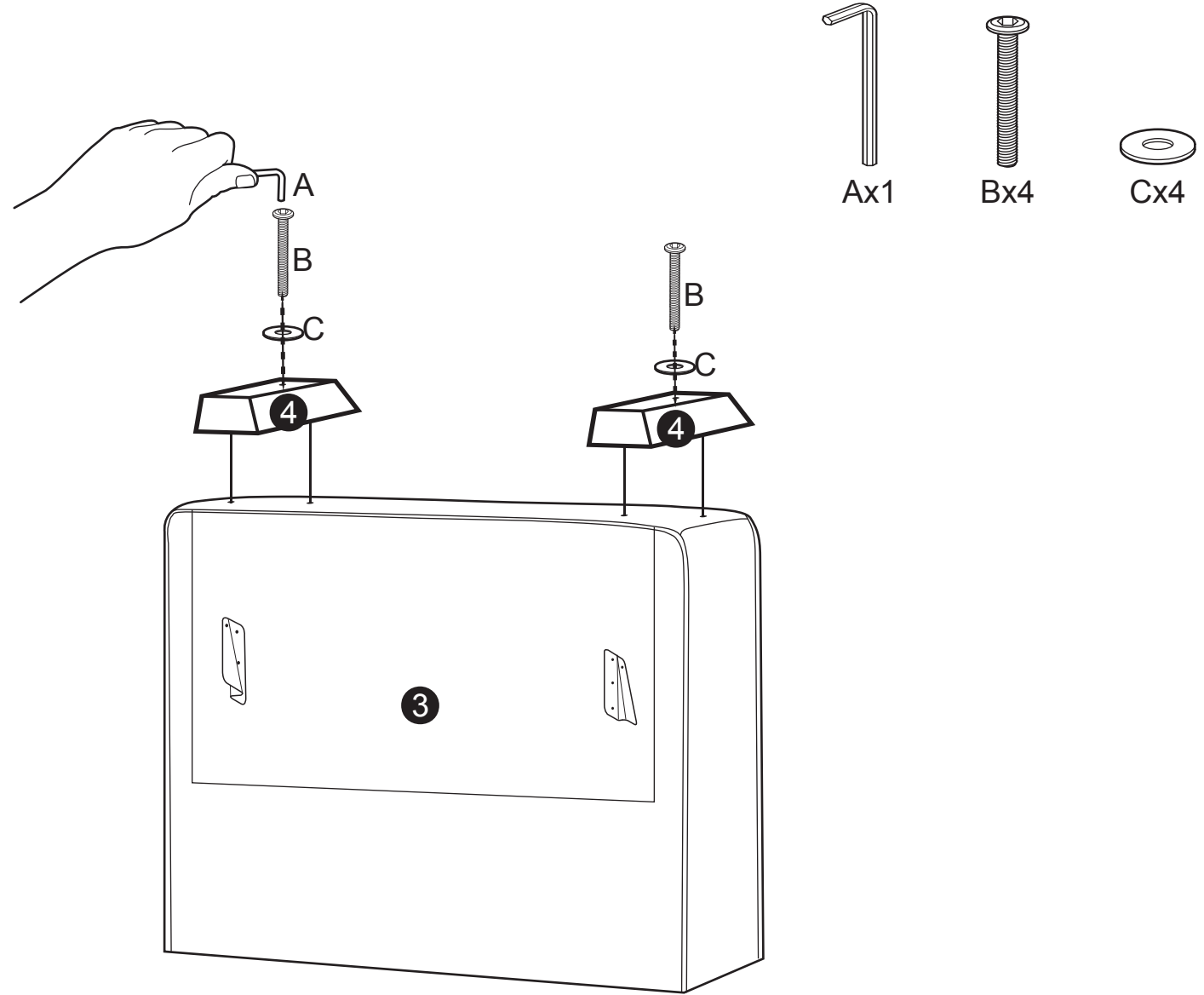

---

Step 2 :

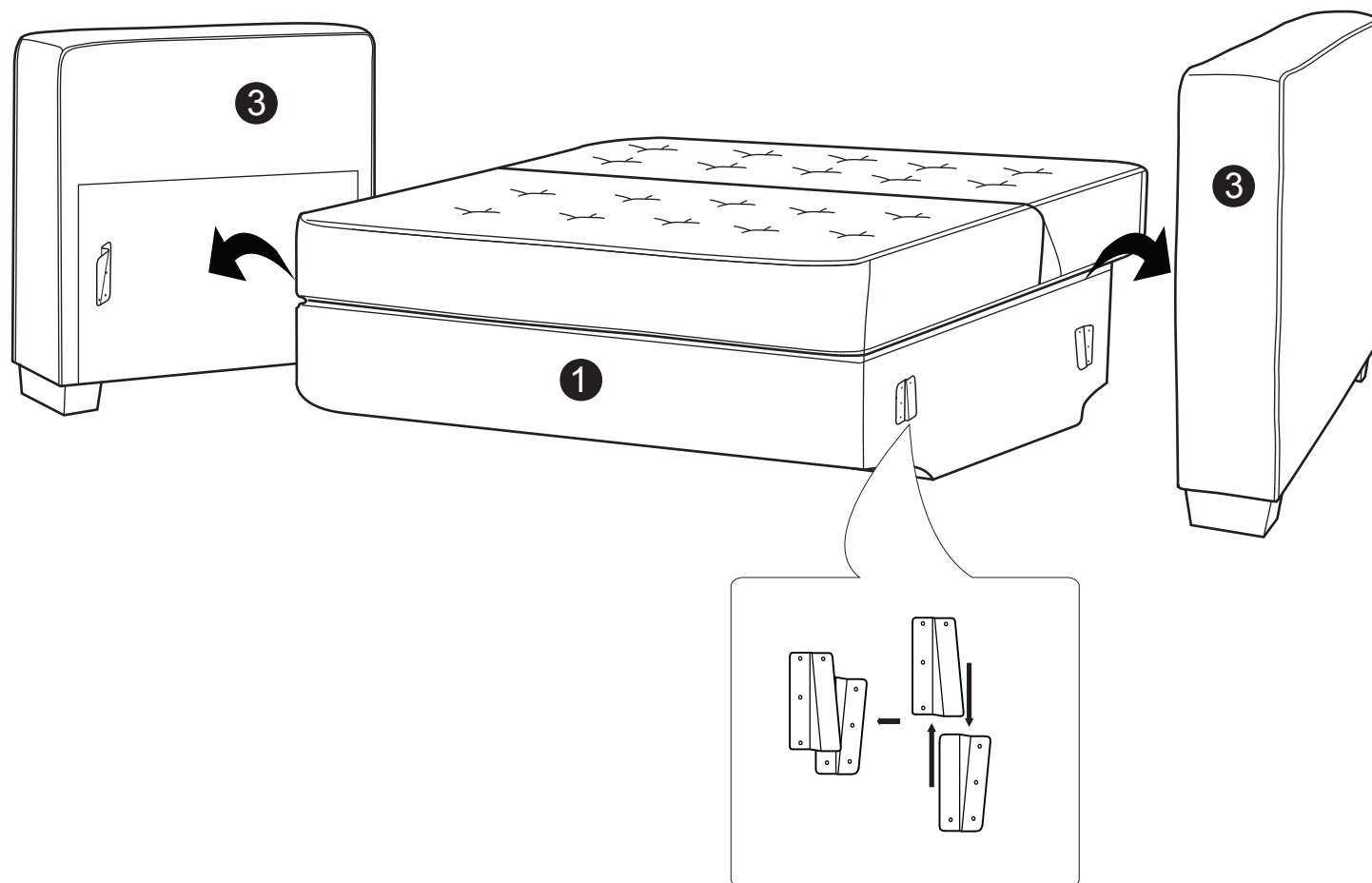

Step 3 :

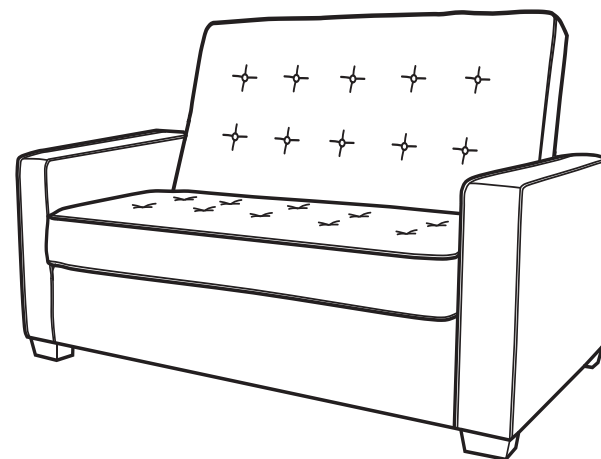
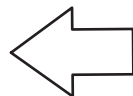
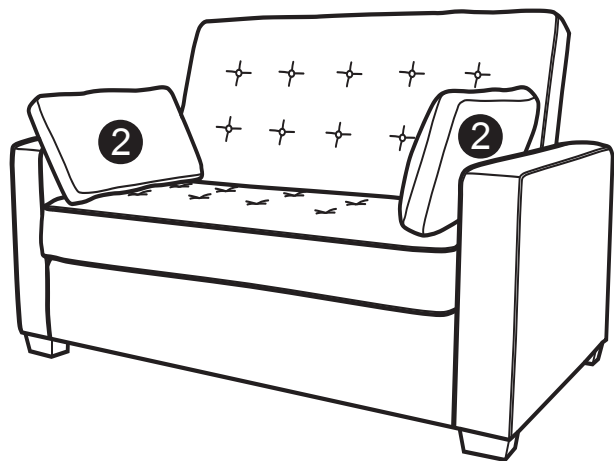
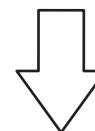
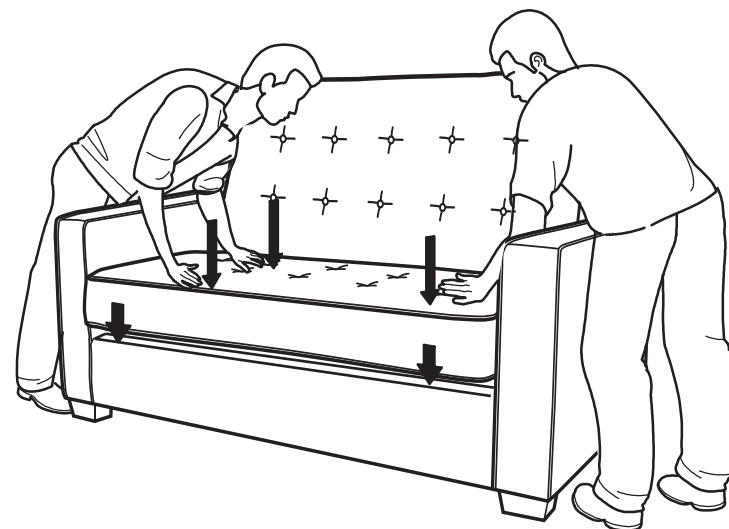
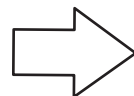
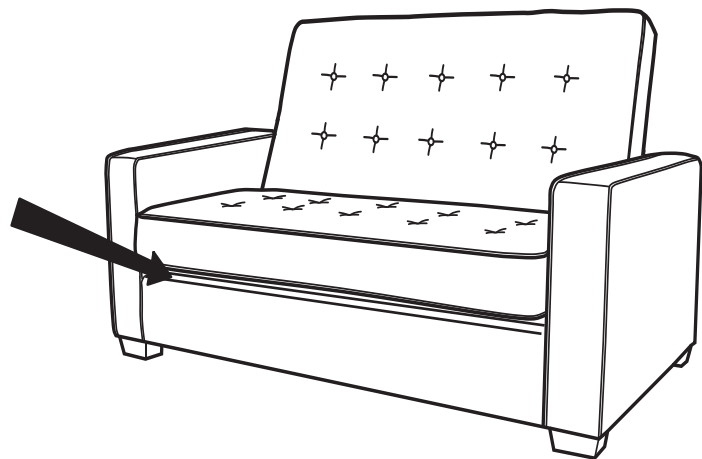

---

FUNCTIONS :

1

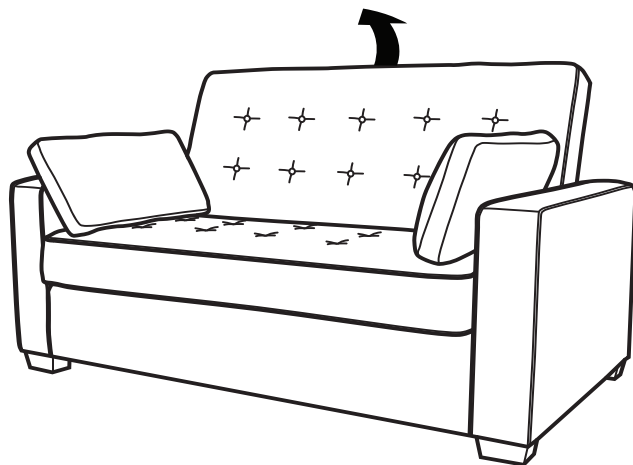

2

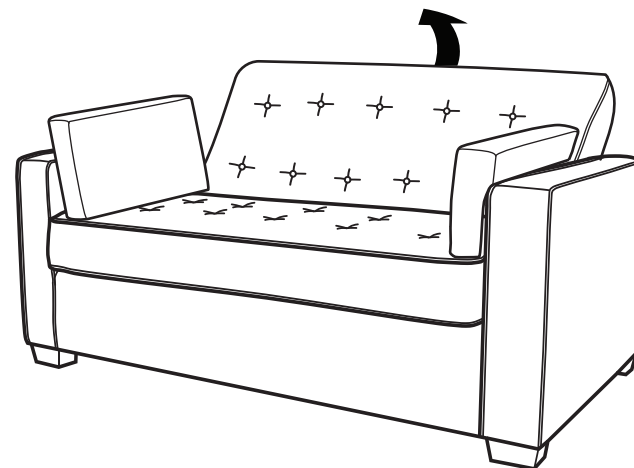

3

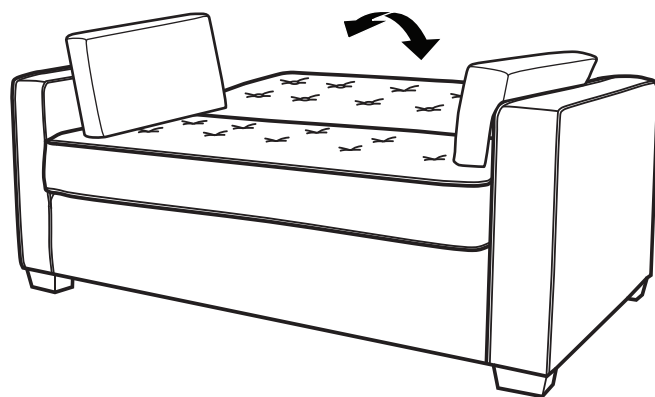

4

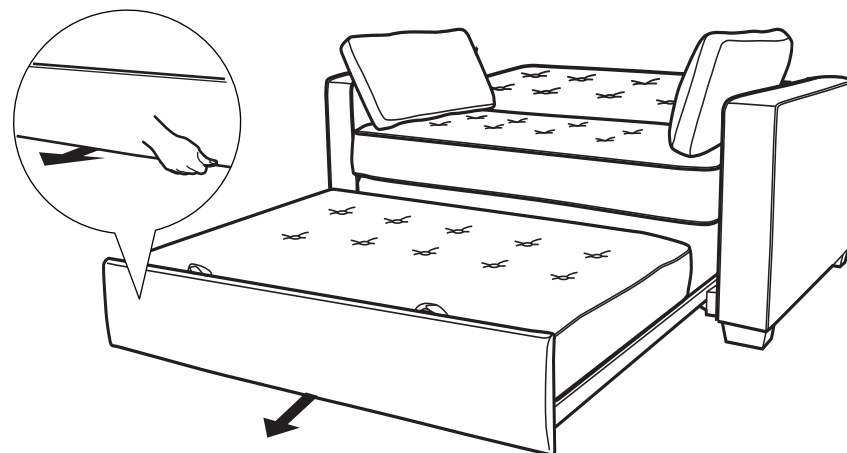

---

FUNCTIONS :

5

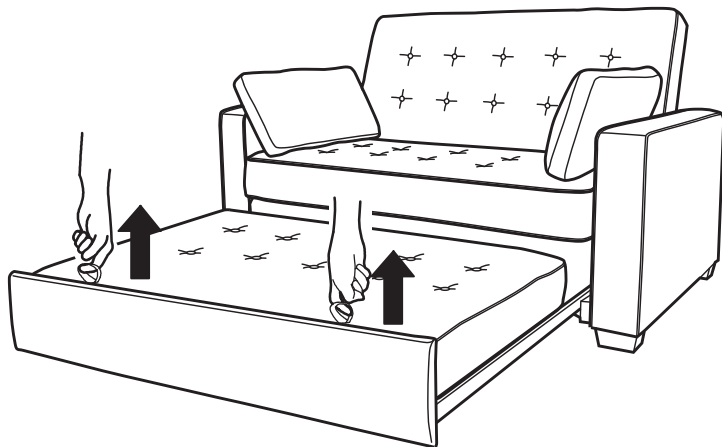

6

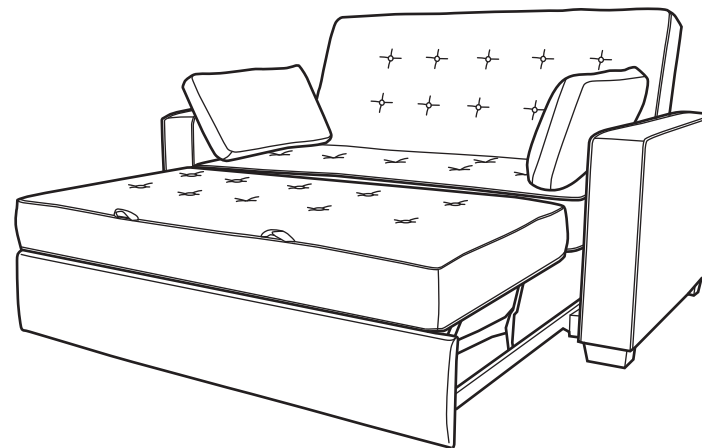

7

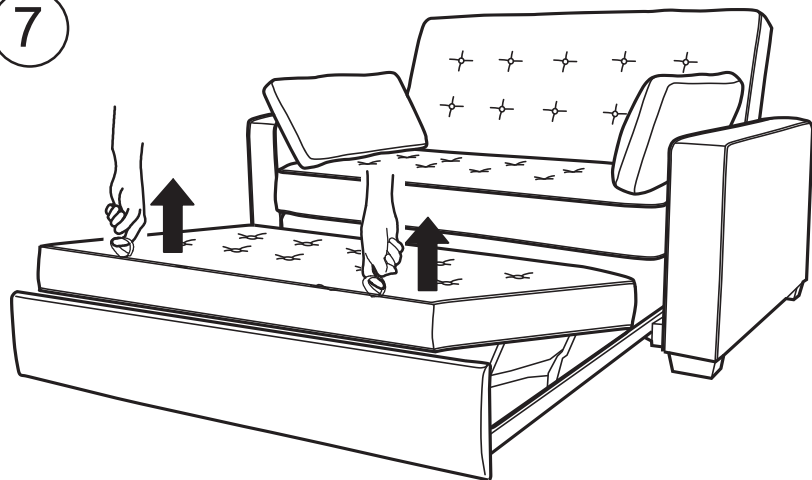

8

