

Features

- Acid-resistant enamel finish.
- Single bowl.
- With integral apron.
- Under-mount (-4U)
- 4-hole (oversized) (-4U)
- 33" (838 mm) x 22-1/8" (562 mm)

Material

- KOHLER® enameled cast iron.

Recommended Accessories

- K-9000 P-Trap
- K-6062 Sink Rack
- K-6539 Drainboard with Sink Rack
- K-6377 Sponge Caddy
- K-6378 Kitchen Brush Caddy
- K-6379 Kitchen Squeegee
- K-6382 Disinfecting Wipes Dispenser
- K-6383 Soap Dispenser
- K-8618 Paper Towel Holder
- K-8619 Flexible Kitchen Mat
- K-8624 Dish Scraper

Optional Accessories

- K-5984 Cutting Board
- K-8801 Sink Strainer



Codes/Standards

















ASME A112.19.1/CSA B45.2

KOHLER® Enameled Cast Iron Kitchen Sink Lifetime Limited Warranty

See website for detailed warranty information.

Available Color/Finishes

Color tiles intended for reference only.

Color	Code	Description
	0	White
	FF	Sea Salt™
	96	Biscuit
	47	Almond
	FD	Cane Sugar™
	NY	Dune
	95	Ice™ Grey
	G9	Sandbar
	33	Mexican Sand™
	K4	Cashmere
	FT	Basalt
	58	Thunder™ Grey
	20	Suede
	KA	Black 'n Tan
	FP	Caviar
	7	Black Black™

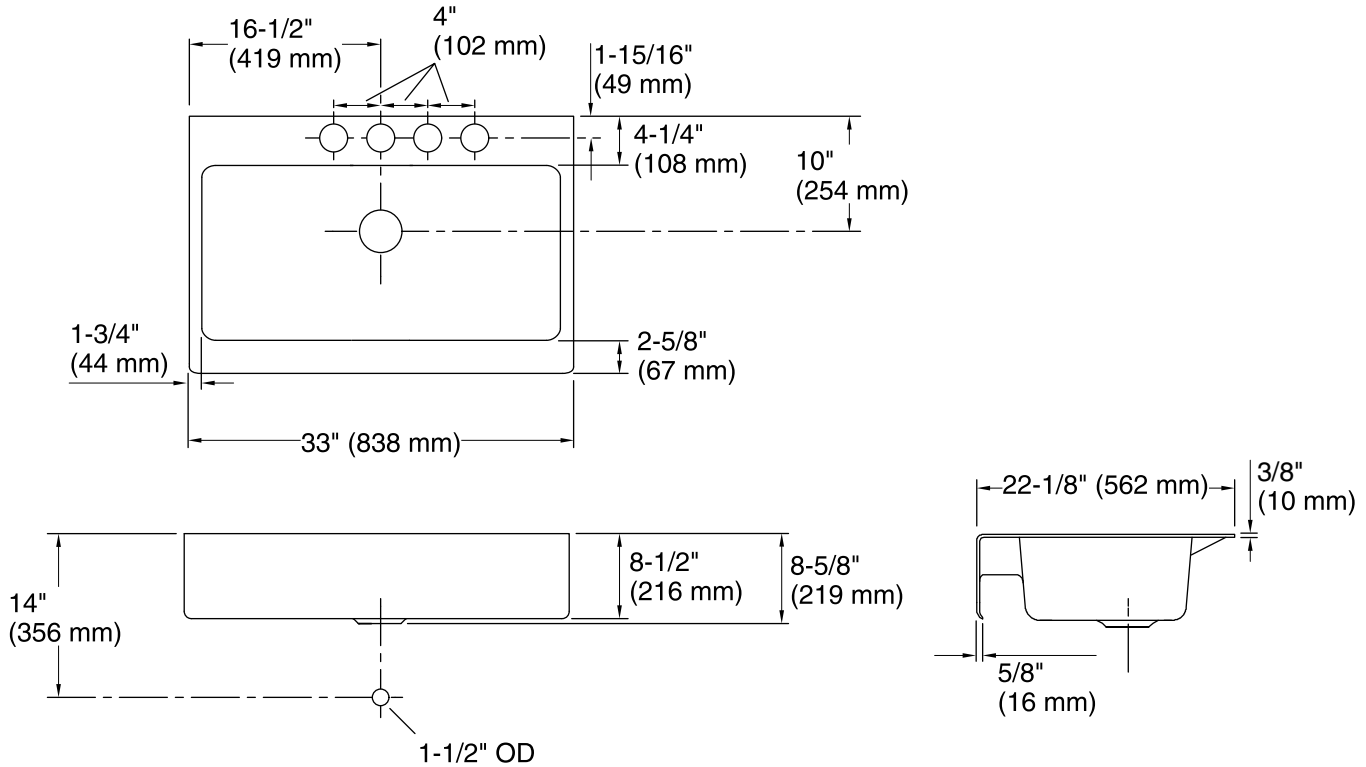

Technical Information

All product dimensions are nominal.

Bowl configuration:	Single
Installation:	Under-mount
Bowl area (Only):	Length: 29-1/2" (749 mm) Width: 15-1/4" (387 mm) Bowl depth: 8-5/8" (220 mm) Water depth: 8" (203 mm)
Number of deck holes:	4
Faucet hole(s):	2-3/8" (60 mm)

Notes

Install this product according to the installation instructions.

Due to the special nature of this installation, Kohler Co. recommends that an experienced cabinet maker use the actual sink to build the new cabinet or modify an existing cabinet.

For under-mount installations, allow a 3/4" (19 mm) reveal to support the K-5984 cutting board.