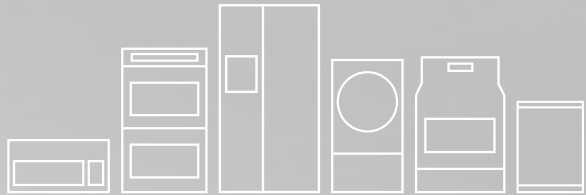


# FRIGIDAIRE

All about the

# Use & Care

of your Wine Cooler



## TABLE OF CONTENTS

Important Safety Instructions.....	2	Features .....	9
Installation .....	4	Proper Use of Wine Cooler .....	10
Door Reversal Instructions .....	5	Care and Cleaning .....	11
Energy Saving Tips.....	7	Before you Call.....	12
Temperature Controls .....	8	Major Appliance Warranty .....	15

# SERIAL/MODEL #'S - IMPORTANT SAFETY INSTRUCTIONS

## Read and Save These Instructions

This Owner's Guide provides specific operating instructions for your model. Use your Wine Cooler only as instructed in this guide. These instructions are not meant to cover every possible condition and situation that may occur. Common sense and caution must be practiced when installing, operating, and maintaining any appliance.

## Record Your Model and Serial Numbers

Record the model and serial numbers in the space provided below. The serial plate is located on the upper left of the interior liner or on the back of the unit.

**Model Number:** \_\_\_\_\_

**Serial Number:** \_\_\_\_\_


**Purchase Date:** \_\_\_\_\_



### WARNING

Please read all instructions before using this wine cooler.

## Definitions

 This is the safety alert symbol. It is used to alert you to potential personal injury hazards. Obey all safety messages that follow this symbol to avoid possible injury or death.



### DANGER

DANGER indicates an imminently hazardous situation which, if not avoided, will result in death or serious injury.



### WARNING

WARNING indicates a potentially hazardous situation which, if not avoided, could result in death or serious injury.



### CAUTION

CAUTION indicates a potentially hazardous situation which, if not avoided, may result in minor or moderate injury.



### IMPORTANT

IMPORTANT indicates installation, operation or maintenance information which is important but not hazard-related.



### WARNING

For Your Safety

Do not store or use gasoline, or other flammable vapors and liquids in the vicinity of this or any other appliance. Read product labels for flammability and other warnings.



### DANGER



DANGER Risk of fire or explosion. Flammable refrigerant used. Do not use mechanical devices to defrost refrigerator. Do not puncture refrigerant tubing.

DANGER Risk of fire or explosion. Flammable refrigerant used. To be repaired only by trained service personnel. Do not puncture refrigerant tubing.



### CAUTION



CAUTION Risk of fire or explosion. Flammable refrigerant used. Consult repair manual/owner's guide before attempting to service this product. All safety precautions must be followed.

CAUTION Risk of fire or explosion. Dispose of property in accordance with federal or local regulations. Flammable refrigerant used.

CAUTION Risk of fire or explosion due to puncture of refrigerant tubing. Follow handling instructions carefully. Flammable refrigerant used.

# IMPORTANT SAFETY INSTRUCTIONS



## WARNING

### Electrical Information

- The wine cooler must be plugged into its own dedicated 115 Volt, 60 Hz., 15 Amp, AC only electrical outlet. The power cord of the appliance is equipped with a three-prong grounding plug for your protection against electrical shock hazards. It must be plugged directly into a properly grounded three prong receptacle. The receptacle must be installed in accordance with local codes and ordinances. Consult a qualified electrician. Avoid connecting refrigerator to a Ground Fault Interruptor (GFI) circuit. Do not use an extension cord or adapter plug.
- If the power cord is damaged, it should be replaced by an authorized service technician to prevent any risk.
- Never unplug the wine cooler by pulling on the power cord. Always grip the plug firmly, and pull straight out from the receptacle to prevent damaging the power cord.
- Unplug the wine cooler before cleaning and before replacing a light bulb to avoid electrical shock.
- Performance may be affected if the voltage varies by 10% or more. Operating the wine cooler with insufficient power can damage the compressor. Such damage is not covered under your warranty.
- Do not plug the unit into an electrical outlet controlled by a wall switch or pull cord to prevent the wine cooler from being turned off accidentally.

### Grounding type wall receptacle



**Do not, under any circumstances, cut, remove, or bypass the grounding prong.**

Power cord with 3-prong grounded plug



## WARNING

### Child Safety

- Destroy carton, plastic bags, and any exterior wrapping material immediately after the wine cooler is unpacked. Children should never use these items to play. Cartons covered with rugs, bedspreads, plastic sheets or stretch wrap may become airtight chambers, and can quickly cause suffocation.
- Remove all staples from the carton. Staples can cause severe cuts, and destroy finishes if they come in contact with other appliances or furniture.
- An empty, discarded wine cooler is a very dangerous attraction to children.
- Remove the door(s) of any appliance that is not in use, even if it is being discarded.



## WARNING

### Proper Disposal of your Wine Cooler

#### Risk of child entrapment

Child entrapment and suffocation are not problems of the past. Junked or abandoned wine coolers are still dangerous – even if they will sit for “just a few days”. If you are getting rid of your old wine cooler, please follow the instructions below to help prevent accidents.

We strongly encourage responsible appliance recycling/disposal methods. Check with your utility company or visit [www.recyclemyoldfridge.com](http://www.recyclemyoldfridge.com) for more information on recycling your old wine cooler.

Before you throw away your old wine cooler:

- Remove doors.
- Leave shelves in place so children may not easily climb inside.
- Have refrigerant removed by a qualified service technician.

# INSTALLATION

This Use & Care Guide provides general operating instructions for your model. Use the appliance only as instructed in this Use & Care Guide. Before starting the wine cooler, follow these important first steps.

## Location

- Choose a place that is near a grounded electrical outlet. Do Not use an extension cord or an adapter plug.
- For optimal performance, it is recommended that you install the wine cooler where the ambient temperature is between 70 and 78 degrees Fahrenheit.
- Leave a 2 inch space at the back of the wine cooler for adequate air circulation.
- Be sure the wine cooler stays in the upright position during transport.
- Keep the wine cooler from any hazardous or combustible agents.

## Leveling

The wine cooler must have all bottom corners resting firmly on solid floor. The floor must be strong enough to support a fully loaded wine cooler. NOTE: It is Very Important for your wine cooler to be level in order to function properly. If the wine cooler is not leveled during installation, the door may be misaligned and not close or seal properly, causing cooling, frost, or moisture problems.

### To Level Your Wine Cooler:

After removing all interior and exterior packaging materials, use a carpenter's level to level the wine cooler from front-to-back. Adjust the leveling legs in front, 1/2 bubble higher, so that the door closes easily when left halfway open.

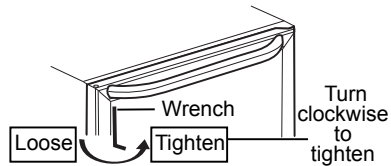
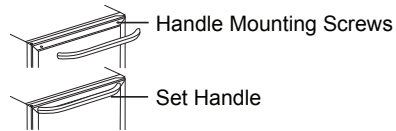
## Cleaning

- Wash any removable parts of the wine cooler interior, and exterior with mild detergent and warm water. Wipe dry. Do not use harsh cleaners on these surfaces.
- Do not use razor blades or other sharp instruments, which can scratch the appliance surface when removing adhesive labels. Any glue left from the tape can be removed with a mixture of warm water and mild detergent, or touch the residue with the sticky side of tape already removed. Do not remove the serial plate.

**Important Safeguards:** Do not store food in your wine cooler as interior temperature may not get cool enough to prevent spoilage. In summer months or areas of high humidity, the glass door may build up moisture. To remove the moisture, wipe it away.

## Handle Installation

1. Place the handle over the two mounting screws at top of door.
2. Tighten the two set screws in bottom of handle using Allen wrench.



# DOOR REVERSAL INSTRUCTIONS

## Reversing the door swing

The glass door can be opened from left to right and vice versa. Should you desire to change the opening direction, please follow these instructions.

### NOTE

Door reversal is not available for a unit with control panel on door. The following operation is only for a unit with control panel inside the cabinet.

**Remarks:** These instructions are based on a unit with right hinge installed already.

To reverse the door from right hinge to left hinge, you will need the extra hinge kit that comes packed inside the unit.

Save all removed parts in case of door re-reversal.

1. Using a Phillips screwdriver, remove the top hinge pin at the top right corner of door. (See Figure 1.)

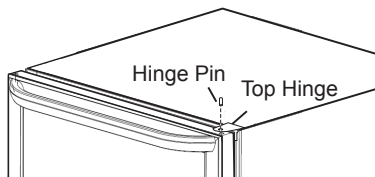


Figure 1

2. Carefully grasp top of door, tilt it forward slightly to clear hinge, then lift the door up off of bottom hinge and place it on a padded surface to prevent scratching it. (See Figure 2.)

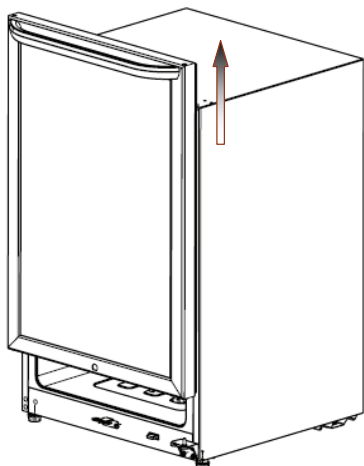


Figure 2

3. Remove the three screws that hold the upper right hinge to the top of the cabinet. (See Figure 3.)

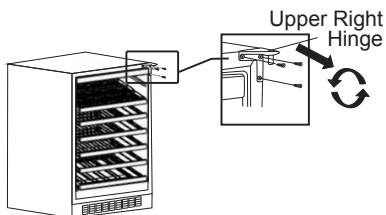


Figure 3

4. Remove the three button plugs from the upper left corner of the cabinet and transfer them to the holes on the opposite side. Be sure to press the button plugs firmly into the holes. Remove screws from each side of toe grille and lay toe grille flat on floor in front of unit. (See Figure 4.)

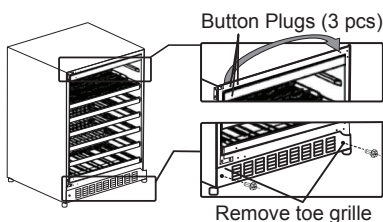


Figure 4

5. Install new left hand top hinge (prepackaged inside unit) at the left hand cabinet corner. (See Figure 5.)

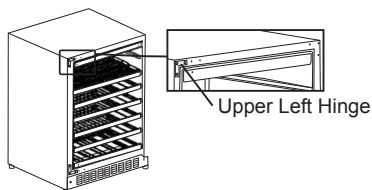
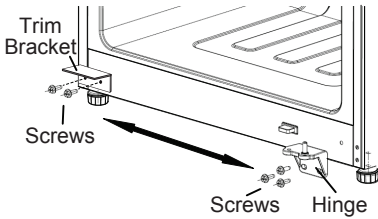


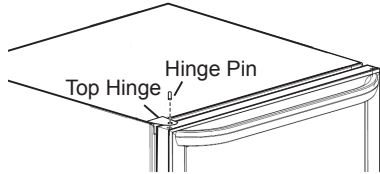
Figure 5

# DOOR REVERSAL INSTRUCTIONS

- Remove three screws that hold the bottom hinge to lower end of cabinet. Remove the trim bracket from lower left hand corner and transfer to holes where bottom hinge was just removed. (See Figure 6.)
- Place bottom left hand corner of door onto lower hinge then tilt top of door back to clear edge of top hinge. Make sure door is level and it seals properly against cabinet then insert hinge pin through hole in top hinge and into door busing. Securely fasten with Phillips screwdriver.. (See Figure 9.)

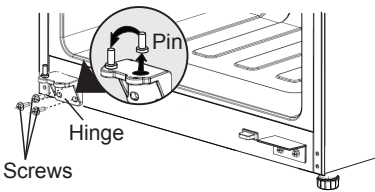


**Figure 6**



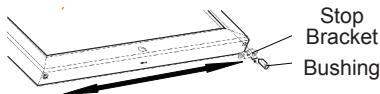
**Figure 9**

- Unscrew hinge pin from bottom hinge and transfer to threaded hole on opposite side. (See Figure 7.) Reinstall bottom hinge in left hand corner of cabinet using same three screws removed in Step 6.
- Reinstall toe grille using same screws removed in Step 4.



**Figure 7**

- On bottom edge of door, transfer door stop bracket and bushing to holes on opposite side. (See Figure 8.)



**Figure 8**

- On top edge of door, transfer the button plugs and bushing to hole on opposite side. (See Figure 9.)




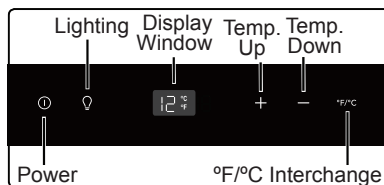
- Install the wine cooler in the coolest part of a dry and ventilated room, out of direct sunlight and away from heating ducts or registers. Do not place the wine cooler next to heat-producing appliances such as a range, oven or dishwasher.
- Level the wine cooler so the door close tightly.
- Do not over crowd the wine cooler or block cold air vents. Doing so causes the wine cooler to run longer and use more energy. Shelves should not be lined with aluminum foil, wax paper or paper toweling. Liners interfere with cold air circulation, making the wine cooler less efficient.
- Wipe containers dry before placing them in the wine cooler. This cuts down on moisture build-up inside the unit.
- Organize the wine cooler to reduce door openings. Remove as many items as needed at one time and close the door as soon as possible.

# TEMPERATURE CONTROLS

## Operation Panel

### Power ON/OFF Control


- When the appliance is plugged into a power outlet, it powers on automatically.
- Touch the power button and hold for five seconds to turn ON/OFF the appliance. 
- After initial startup the display will default to 54°F (12°C).



## IMPORTANT

To avoid damaging the compressor, please do not turn on the appliance again within 5 minutes after turning it off.

### Interior Lighting ON/OFF control

- Touch the light button to turn ON/OFF the interior LED lighting. 
- The light will stay on until it is manually turned off or the door is closed.

### Temperature Display Window

- The temperature is displayed digitally. The digital display shows the set temperature.
- If the temperature probe is out of order or some other error occurs, the display window may show a code such as "E1", "L" or "H" instead of the actual temperature and a continuous beeping sound will be heard. In case this happens, the appliance is designed to keep periodical running of compressor and fans which helps to maintain an adequate temperature inside cabinet to protect your stored wines, but it is recommended that you have your unit serviced as soon as possible.

### Temperature Setting

- The temperature setting range is as below.

41°F → 42°F → 43°F → 44°F → 45°F → ..... → 62°F → 63°F → 64°F

5°C → 6°C → 7°C → 8°C → 9°C → ..... → 16°C → 17°C → 18°C



## NOTE

When the highest/lowest temperature is reached, display will beep. Touch again to increase/decrease the temperature to desired setting.

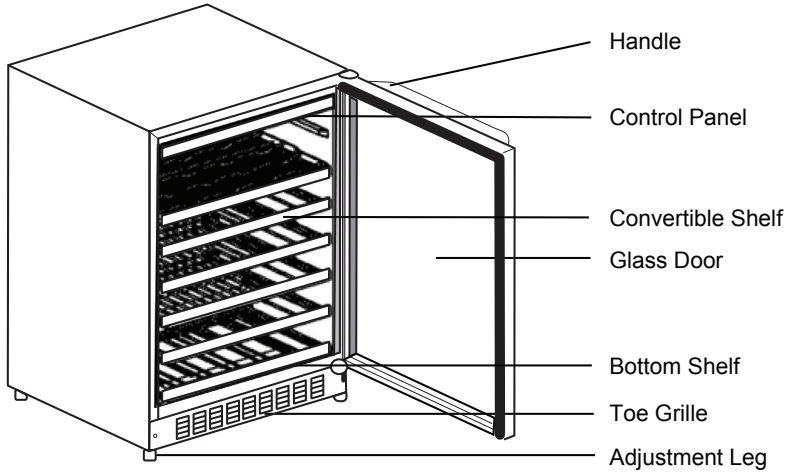
- Directly touch the + or – button to set the wine cooler temperature.
- The first touch on the + or – button will recall the previous set temperature displayed.
- Touch the + button to increase the set temperature by 1°F (or by 1°C). On the contrary, touch the – button to decrease the set temperature by 1°F (or by 1°C).
- The digital display will change to show the set temperature of the inside cabinet after 10 seconds without being touched.

### Selecting Fahrenheit (°F) & Celsius (°C) Display

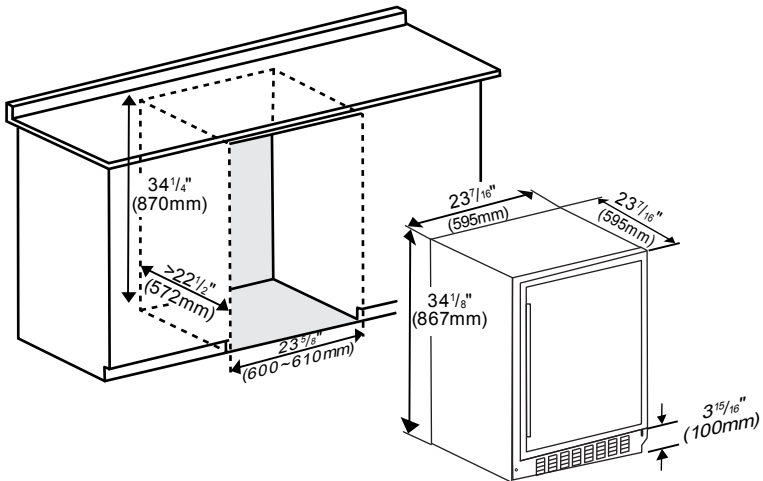
Quickly press and release the F/C button to switch the Fahrenheit and Celsius temperature. The display window will show the Fahrenheit and Celsius temperature setting of the current mode.



## Names of Components



## Height Adjustable 868-890mm



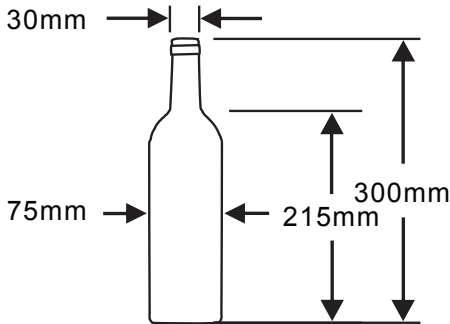
### IMPORTANT

Your model and features may vary slightly from illustrations shown here.

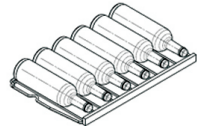
# PROPER USE OF WINE COOLER

## The arrangement of Bottle

- Do not let bottles touch the rear panel in order to maintain good air circulation in the cooler.
- The amount of bottle storage listed will vary depending on bottle shape and size.
- The capacity for bottle storage in the wine cooler is based on the following marked bottle size. Oversized bottles may impact the number of bottles that can be stored on some of the shelves.



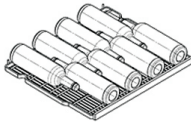
## 4. Bottom Shelf



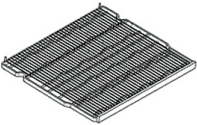
### NOTE

Convertible shelf can only be used in the second position from the top.

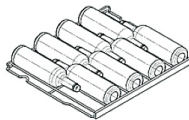
1. Convertible Shelf - when vertical will support 8 bottles of wine.



2. Convertible Shelf - when turned over 180 degrees, will support up to 36 (12 ounce) cans, the top shelf will have to be removed to allow clearance for the cans.



3. Full Depth Middle Shelves



## Cleaning the wine cooler

- Before cleaning, turn the temperature control to OFF, unplug the wine cooler and remove the bottles.
- Clean your wine cooler once every two months.

**Inside:** Wash inside surfaces of the wine cooler with a solution of two tablespoons of baking soda in one quart (1.136 liters) warm water. Rinse and dry. Wring excess water out of the sponge or cloth when cleaning in the area of the controls, or any electrical parts.

Wash the removable parts with the baking soda solution mentioned above, or mild detergent and warm water. Rinse and dry. Never use metallic scouring pads, brushes, abrasive cleaners, or alkaline solutions on any surface. Do not wash removable parts in a dishwasher.

**Outside:** Wash the cabinet with warm water and mild liquid detergent. Rinse well and wipe dry with a clean soft cloth.

## Care of plastic parts

- Be sure and protect the door gasket. It should be kept clean at all times.
- If the plastic parts in the wine cooler remain contaminated by oil (animal or vegetable) for a long period of time, they will age and crack easily. Please clean them on a regular basis.

## Vacation and Moving Tips

**Vacations:**

If the wine cooler will not be used for several months:

- Remove all wine bottles and unplug the power cord.
- Clean and dry the interior thoroughly.
- Leave the wine cooler door open slightly, blocking it open if necessary, to prevent odor and mold growth.

**Moving:** When moving the wine cooler, follow these guidelines to prevent damage:

- Disconnect the power cord plug from the wall outlet.
- Remove wine bottles and clean the wine cooler.
- Secure all loose items by taping them securely in place to prevent damage.

- In a moving vehicle, secure the wine cooler in an upright position to prevent movement. Also, protect the outside of the wine cooler with a blanket or similar item.



## WARNING

If leaving the wine cooler door open while on vacation, make certain that children cannot climb inside and become entrapped.

# BEFORE YOU CALL

**1-800-944-9044** (United States)

**1-800-265-8352** (Canada)

Visit our web site at

**[www.frigidaire.com](http://www.frigidaire.com)**

<b>PROBLEM</b>	<b>CAUSE</b>	<b>CORRECTION</b>
<b>WINE COOLER OPERATION</b>		
Wine Cooler does not run.	<ul style="list-style-type: none"> <li>• Wine cooler is plugged into a circuit that has a ground fault interrupt.</li> <li>• Temperature control is in the OFF position.</li> <li>• Wine cooler may not be plugged in, or plug may be loose.</li> <li>• House fuse blown or tripped circuit breaker.</li> <li>• Power outage.</li> </ul>	<ul style="list-style-type: none"> <li>• Use another circuit. If you are unsure about the outlet, have it checked by a certified technician.</li> <li>• See Setting the Temperature Control section.</li> <li>• Ensure plug is tightly pushed into outlet.</li> <li>• Check/replace fuse with a 15 amp time-delay fuse. Reset circuit breaker.</li> <li>• Check house lights. Call local Electric Company.</li> </ul>
Wine Cooler runs too much or too long.	<ul style="list-style-type: none"> <li>• Room or outside weather is hot.</li> <li>• Wine Cooler has recently been disconnected for a period of time.</li> <li>• Large amounts of warm or hot food has been stored recently.</li> <li>• Door is opened too frequently or too long.</li> <li>• Wine Cooler door may be slightly open.</li> <li>• Temperature control is set too low.</li> <li>• Wine Cooler gasket is dirty, worn, cracked, or poorly fitted.</li> </ul>	<ul style="list-style-type: none"> <li>• It's normal for the Wine Cooler to work harder under these conditions.</li> <li>• It takes 4 hours for the Wine Cooler to cool down completely.</li> <li>• Warm food will cause Wine Cooler to run more until the desired temperature is reached.</li> <li>• Warm air entering the Wine Cooler causes it to run more. Open doors less often.</li> <li>• Make sure door is completely closed and properly aligned.</li> <li>• Adjust control to a warmer setting. Allow several hours for the temperature to stabilize.</li> <li>• Clean or change gasket. Leaks in the door seal will cause Wine Cooler to run longer in order to maintain desired temperature.</li> </ul>
Interior Wine Cooler temperature is too cold.	<ul style="list-style-type: none"> <li>• Temperature control is set too low.</li> </ul>	<ul style="list-style-type: none"> <li>• Turn the control to a warmer setting. Allow several hours for the temperature to stabilize.</li> </ul>

# BEFORE YOU CALL (continued)

PROBLEM	CAUSE	CORRECTION
<b>WINE COOLER OPERATION (cont'd)</b>		
Interior Wine Cooler temperature is too warm.	<ul style="list-style-type: none"> <li>• Temperature control is set too warm.</li> <li>• Door is opened too frequently or too long.</li> <li>• Door may not be seating properly.</li> <li>• Large amounts of warm or hot food has been stored recently.</li> <li>• Wine Cooler has recently been disconnected for a period of time.</li> </ul>	<ul style="list-style-type: none"> <li>• Turn control to a colder setting. Allow several hours for the temperature to stabilize.</li> <li>• Warm air entering the Wine Cooler causes it to run more. Open doors less often.</li> <li>• Check for proper alignment of door and gasket.</li> <li>• Warm food will cause Wine Cooler to run more until the desired temperature is reached.</li> <li>• It takes 4 hours for the Wine Cooler to cool down completely.</li> </ul>
<b>SOUND AND NOISE</b>		
Louder sound levels when wine cooler is on.	<ul style="list-style-type: none"> <li>• Modern wine coolers have increased storage capacity and more stable temperatures. They require a high efficiency compressor</li> </ul>	<ul style="list-style-type: none"> <li>• This is normal. When the surrounding noise level is low, you might hear the compressor running while it cools the interior.</li> </ul>
Longer sound levels when compressor comes on.	<ul style="list-style-type: none"> <li>• Wine Cooler operates at higher pressures during the start of the ON cycle.</li> </ul>	<ul style="list-style-type: none"> <li>• This is normal. Sound will level off or disappear as refrigerator continues to run.</li> </ul>
Popping or cracking sound when compressor comes on.	<ul style="list-style-type: none"> <li>• Metal parts undergo expansion and contraction, as in hot water pipes.</li> </ul>	<ul style="list-style-type: none"> <li>• This is normal. Sound will level off or disappear as Wine Cooler continues to run.</li> </ul>
Boiling or gurgling sound, like water boiling.	<ul style="list-style-type: none"> <li>• Refrigerant (used to cool Wine Cooler) is circulating throughout the system.</li> </ul>	<ul style="list-style-type: none"> <li>• This is normal.</li> </ul>
Vibrating or rattling noise.	<ul style="list-style-type: none"> <li>• Wine Cooler is not level. It rocks on the floor when it is moved slightly.</li> </ul>	<ul style="list-style-type: none"> <li>• Level the unit. Refer to leveling instructions in the "Installation" section.</li> </ul>
Snapping sound.	<ul style="list-style-type: none"> <li>• Cold control turning the Wine Cooler OFF and ON.</li> </ul>	<ul style="list-style-type: none"> <li>• This is normal.</li> </ul>
<b>WATER/MOISTURE/FROST INSIDE WINE COOLER</b>		
Moisture forms on inside of Wine Cooler walls.	<ul style="list-style-type: none"> <li>• Weather is hot and humid.</li> <li>• Door may not be seating properly.</li> <li>• Door is kept open too long, or opened too frequently.</li> </ul>	<ul style="list-style-type: none"> <li>• This is normal.</li> <li>• Check for proper alignment of door and gasket.</li> <li>• Open the door less often.</li> </ul>

## BEFORE YOU CALL (continued)

PROBLEM	CAUSE	CORRECTION
<b>WATER/MOISTURE/FROST OUTSIDE WINE COOLER</b>		
Moisture forms on outside of Wine Cooler.	<ul style="list-style-type: none"> <li>• Door may not be seating properly, causing the cold air from inside the wine cooler to meet warm moist air from outside.</li> </ul>	<ul style="list-style-type: none"> <li>• Check for proper alignment of door and gasket.</li> </ul>
<b>ODOR IN WINE COOLER</b>		
Odors in Wine Cooler.	<ul style="list-style-type: none"> <li>• Interior needs to be cleaned.</li> </ul>	<ul style="list-style-type: none"> <li>• Clean interior with sponge, warm water, and baking soda.</li> </ul>
<b>DOOR PROBLEMS</b>		
Door will not close.	<ul style="list-style-type: none"> <li>• Wine Cooler is not level. It rocks on the floor when it is moved slightly.</li> </ul>	<ul style="list-style-type: none"> <li>• This condition may force the cabinet out of square and misalign the door. Refer to "Leveling" in the "Installation" section.</li> </ul>
<b>LIGHT BULB IS NOT ON</b>		
Light bulb is not on.	<ul style="list-style-type: none"> <li>• No electric current is reaching the Wine Cooler.</li> </ul>	<ul style="list-style-type: none"> <li>• Ensure plug is tightly pushed into electrical outlet.</li> <li>• Check/replace fuse with a 15 amp time-delay fuse. Reset circuit breaker.</li> </ul>

# MAJOR APPLIANCE WARRANTY

Your appliance is covered by a one year limited warranty. For one year from your original date of purchase, Electrolux will pay all costs for repairing or replacing any parts of this appliance that prove to be defective in materials or workmanship when such appliance is installed, used and maintained in accordance with the provided instructions.

## Exclusions

### This warranty does not cover the following:

1. Products with original serial numbers that have been removed, altered or cannot be readily determined.
2. Product that has been transferred from its original owner to another party or removed outside the USA or Canada.
3. Rust on the interior or exterior of the unit.
4. Products purchased "as-is" are not covered by this warranty.
5. Food loss due to any refrigerator or freezer failures.
6. Products used in a commercial setting.
7. Service calls which do not involve malfunction or defects in materials or workmanship, or for appliances not in ordinary household use or used other than in accordance with the provided instructions.
8. Service calls to correct the installation of your appliance or to instruct you how to use your appliance.
9. Expenses for making the appliance accessible for servicing, such as removal of trim, cupboards, shelves, etc., which are not a part of the appliance when it is shipped from the factory.
10. Service calls to repair or replace appliance light bulbs, air filters, water filters, other consumables, or knobs, handles, or other cosmetic parts.
11. Surcharges including, but not limited to, any after hour, weekend, or holiday service calls, tolls, ferry trip charges, or mileage expense for service calls to remote areas, including the state of Alaska.
12. Damages to the finish of appliance or home incurred during installation, including but not limited to floors, cabinets, walls, etc.
13. Damages caused by: services performed by unauthorized service companies; use of parts other than genuine Electrolux parts or parts obtained from persons other than authorized service companies; or external causes such as abuse, misuse, inadequate power supply, accidents, fires, or acts of God.

## DISCLAIMER OF IMPLIED WARRANTIES; LIMITATION OF REMEDIES

CUSTOMER'S SOLE AND EXCLUSIVE REMEDY UNDER THIS LIMITED WARRANTY SHALL BE PRODUCT REPAIR OR REPLACEMENT AS PROVIDED HEREIN. CLAIMS BASED ON IMPLIED WARRANTIES, INCLUDING WARRANTIES OF MERCHANTABILITY OR FITNESS FOR A PARTICULAR PURPOSE, ARE LIMITED TO ONE YEAR OR THE SHORTEST PERIOD ALLOWED BY LAW, BUT NOT LESS THAN ONE YEAR. ELECTROLUX SHALL NOT BE LIABLE FOR CONSEQUENTIAL OR INCIDENTAL DAMAGES SUCH AS PROPERTY DAMAGE AND INCIDENTAL EXPENSES RESULTING FROM ANY BREACH OF THIS WRITTEN LIMITED WARRANTY OR ANY IMPLIED WARRANTY. SOME STATES AND PROVINCES DO NOT ALLOW THE EXCLUSION OR LIMITATION OF INCIDENTAL OR CONSEQUENTIAL DAMAGES, OR LIMITATIONS ON THE DURATION OF IMPLIED WARRANTIES, SO THESE LIMITATIONS OR EXCLUSIONS MAY NOT APPLY TO YOU. THIS WRITTEN WARRANTY GIVES YOU SPECIFIC LEGAL RIGHTS. YOU MAY ALSO HAVE OTHER RIGHTS THAT VARY FROM STATE TO STATE.

## If You Need Service

Keep your receipt, delivery slip, or some other appropriate payment record to establish the warranty period should service be required. If service is performed, it is in your best interest to obtain and keep all receipts. Service under this warranty must be obtained by contacting Electrolux at the addresses or phone numbers below.

This warranty only applies in the USA and Canada. In the USA, your appliance is warranted by Electrolux Major Appliances North America, a division of Electrolux Home Products, Inc. In Canada, your appliance is warranted by Electrolux Canada Corp. Electrolux authorizes no person to change or add to any obligations under this warranty. Obligations for service and parts under this warranty must be performed by Electrolux or an authorized service company. Product features or specifications as described or illustrated are subject to change without notice.

## USA

1.800.944.9044

Frigidaire

10200 David Taylor Drive  
Charlotte, NC 28262



**Electrolux**

## Canada

1.800.265.8352

Electrolux Canada Corp.

5855 Terry Fox Way  
Mississauga, Ontario, Canada  
L5V 3E4