

BROWN JORDAN®

EXCLUSIVELY FOR THE HOME DEPOT

ASSEMBLY INSTRUCTIONS

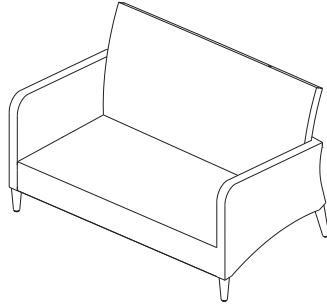

MARQUIS Loveseat

Assembly Steps:

Step1: Take M6X15 Hex Head Bolt (D), M6 Washer (E) and Hex Wrench (F) out. Lay the Loveseat Frame (A) down. Put the Front Teak Legs (B) into the front and the Back Teak Legs (C) into the back of the Loveseat Frame (A). Put the M6X15 Hex Head Bolt (D) through the Washer (E), then fix the legs.







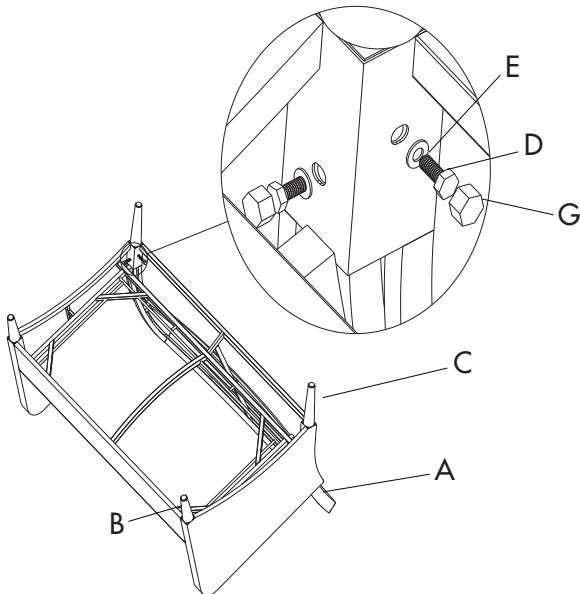

Step2: Fix all the Hex Head Bolts (D) with the M6 Hex Wrench (F). Put the Nut Caps (G) on and turn the frame side up.

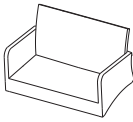
Step3: Put the Back Cushion (I), Seat Cushion (H) and Lumbar Pillow (J) on the loveseat.

Enjoy your new Brown Jordan furniture.

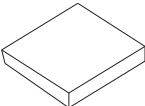

Parts List:

	Part Name	Picture	Qty
A	Loveseat Frame		1
B	Front Teak Legs		2
C	Back Teak Legs		2
D	M6x15mm Hex Head Bolt		8
E	M6 Washer		8
F	Hex Wrench		1
G	Nut cap		8
H	Seat Cushion		1
I	Back Cushion		1
J	Lumbar Pillow		1