



12x8 Cabana Garden Shed Assembly Manual

Revision #18
January 9, 2018

Thank you for purchasing our 12x8 Cabana Garden Shed. Please take the time to identify all the parts prior to assembly.

Safety Points and Other considerations:

Our products are built for use based on proper installation and normal residential use, on level ground. Please follow the instruction manual when building your Cabana and retain the manual for future maintenance purposes.



Some of the safety and usage measures you may wish to consider include:

- snow load ratings vary by geographical location. If heavy or wet snowfall occurs, it is advisable to sweep the snow off the roof(s).
- if the product is elevated, any structural and building code requirements are solely the customer's responsibility, and should be abided by.
- in high or gusty wind conditions it is advisable to keep the structure securely grounded.
- have a regular maintenance plan to ensure screws, doors, windows and parts are tight.

Customer agrees to hold Outdoor Living Today Partnership and any Authorized Dealers free of any liability for improper installation, maintenance and repair.

In the event of a missing or broken piece, simply call the Outdoor Living Today Customer Support Line @ 1-888-658-1658 within 30 days of the delivery of your purchase. It is our commitment to you to courier replacement parts, free of charge, within 10 business days of this notification. Replacement parts will not be provided free of charge after the 30 day grace period.

**Thank you for purchasing our 12x8 Cabana Garden Shed.
Please take the time to identify all the parts prior to assembly.**

Parts List:

A. Floor Section

- 3 - 45 1/2" x 75" - Floor Joist Frames
- 6 - 1 1/2" x 3 1/2" x 71 3/4" - Center Floor Joists - Unattached
- 3 - 45 1/2" x 21" - Floor Joist Frames
- 3 - 45 3/8" x 74 7/8" - Plywood Floor - Large
- 3 - 45 3/8" x 20 7/8" - Plywood Floor - Small

- 10- 1 1/2" x 3 1/2" x 68 3/16" Floor Runners

B. Wall Section

- 7 - 45 1/2" x 75" - Solid Wall Panels
- 7 - 1 1/2" x 2 1/2" x 45 1/2" Bottom Wall Plates
- 2 - 45 1/2" x 75" - Window Wall Panels
- 1 - 12" x 73" - Narrow Wall Panel

Door Jambs & Header

- 1 - 1 1/2" x 3" x 73" - Vertical Door Jamb
- 1 - 2"x 3" x 45 1/2" - Door Header (Dado cut on edge)
- 2 - 2 1/2" x 1/2" x 72" - Interior Vertical Door Stops
- 1 - 2 1/2" x 1/2" x 36" - Interior Top Horizontal Door Stop
- 1 - 31 1/2" x 42" - Bottom Dutch Door Section
- 1 - 31 1/2" x 30" - Top Dutch Door Section

Gable Walls

- 4 - Gable Half Walls - Triangular Shaped

Top Wall Plates

- 6 - 3/4" x 2 1/2" x 32" - Side Top Plates
(4 pieces Angle cut on end, 2 piece straight cut both ends)
- 4 - 3/4" x 2 1/2" x 65 3/4" Front & Rear Top Plates
(Angle cut on edge -65 3/4")

C. Rafter Section

- 18- 1 1/2" x 3 1/2" x 56 1/2" - Roof Rafters
- 2 - 3/4" x 4 1/2" x 84" - Roof Ridge Boards
- 2 - 3/4" x 4 1/2" x 52 1/2" - Roof Ridge Boards
- 4- 1/2" x 4 1/2" x 68 1/4" - Soffits

D. Roof Section

- 4 - Outside Rear Roof Panels (Shingles overhanging roof battens on 1 end)
- 2 - Middle Roof Panel (Shingles flush with roof battens both ends)
- 3 - 3/4" x 3 1/2" x 72" Roof Gussets - (angle cut on ends)
- 4 - 3/4" x 2 1/2" x 48" Facia/Roof Nailing Strips

E. Miscellaneous Section

Ridge Caps

- 22 - Cedar Roof Ridge Caps

Bottom Skirting

- 10 - 1/2" x 4 1/2" x 45 1/4" - Side Bottom Skirting

Corner & Sidewall Trim

- 9 - 1/2" x 2 1/2" x 79" - Narrow Trims
- 2 - 1/2" x 2 1/2" x 77 1/2" - Narrow Trims - Sidewalls
- 4 - 1/2" x 2 1/2" x 75" - Filler Trim
- 4 - 1/2" x 4 1/2" x 82" - Wide Corner Trim
- 4 - 1/2" x 4 1/2" x 44 1/2" - Horizontal Gable Trim
- 1 - 1/2" x 1 1/4" x 32" - Horizontal Door Trim
- 1 - 1/2" x 1 1/4" x 8" - Horizontal Narrow Wall Trim

Facia Trim

- 4 - 3/4" x 3 1/2" x 58" - Side Facia
(Angle cut on ends - 2 right / 2 left)
- 4 - 3/4" x 3 1/2" x 71 3/4" - Front and Rear Facia)

Filler Shingles (5 1/2" wide)

- 16 pcs - Long
- 4 pcs - Short

Misc. Pieces

- 2 - Flower Box Kits
- 2 - Pentagon Facia Plate - For Side Facia Peaks
- 2 - Metal Window Inserts
- 2 - Window Trim Pkg - (1-24 1/16" angle cut / 3 -23" square cut)
- 2 - 4 1/2" high Horizontal Gable Trim Detail Plates - Large
- 2 - 3 1/2" high Facia Detail Plates - Small
- 1 pc - Spare Wall Siding
- 2 pcs - Spare Shingles- use to shim door, etc

12 x 8 CABANA HARDWARE SHEET

Hardware Kit (Provided)

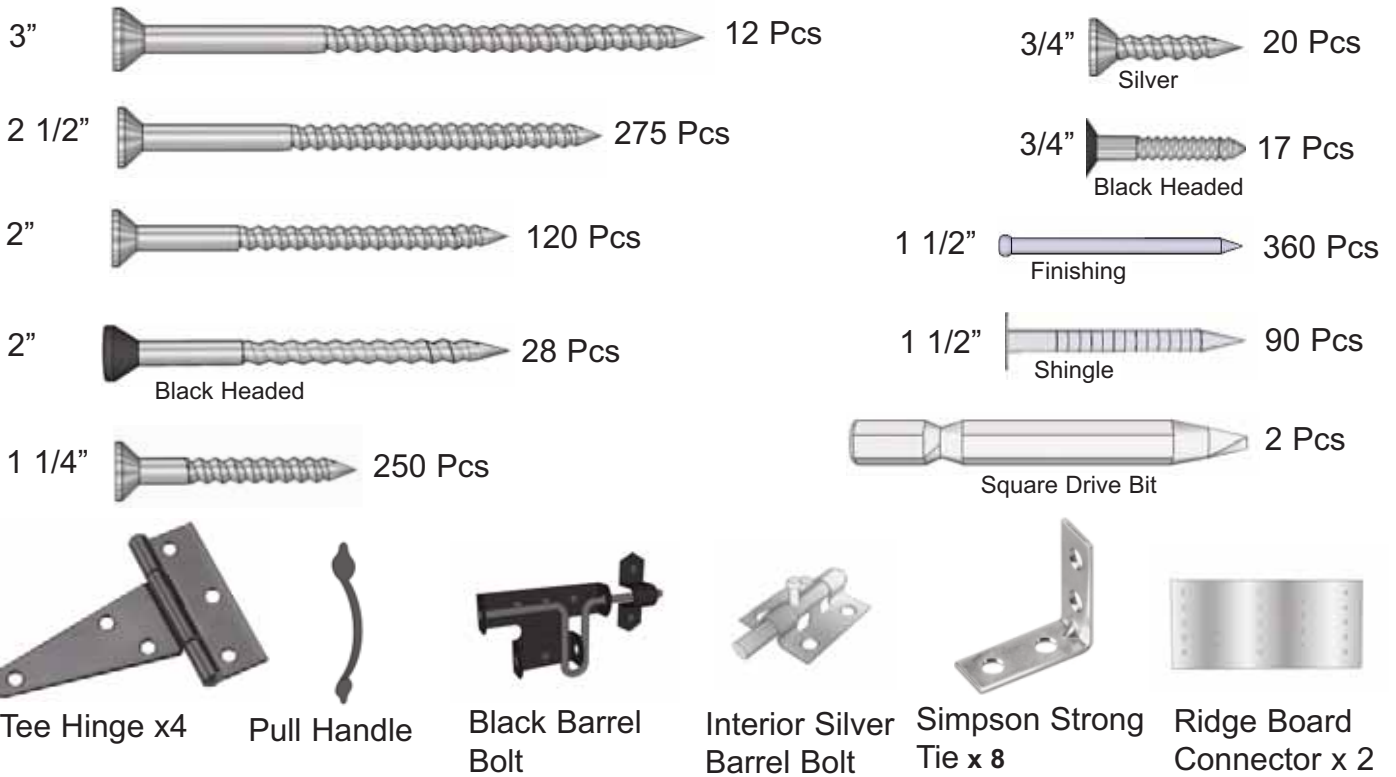

Tools Required (Not Provided)



Safety Equipment Required (Not Provided)



A. Floor Section

Exploded view of all parts necessary to complete Floor Section. Identify all parts prior to starting. Note: Floor Footprint is 136 1/2" wide x 96" deep.

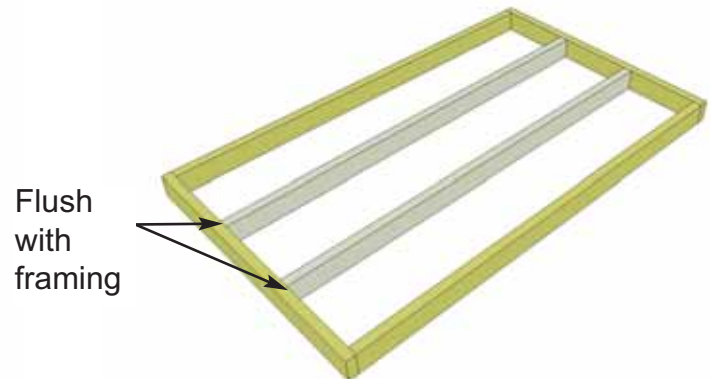
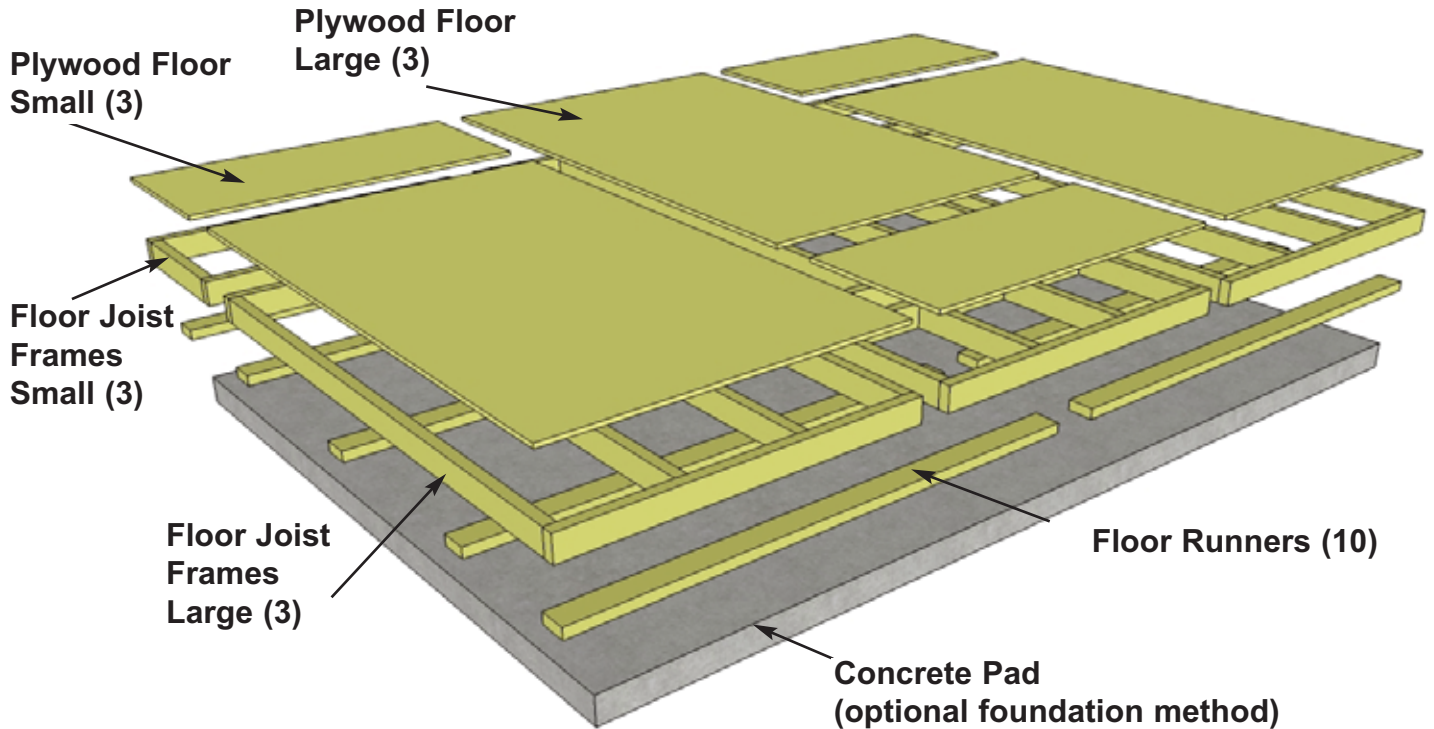

1. Lay out **Large Floor Joist Frame** and **2 Floor Joists** as illustrated above. Position Joists equally in Floor Joist Frame. Use **Small Floor Joist Frame** as a template to determine joist position. Position Joist so flush with framing.

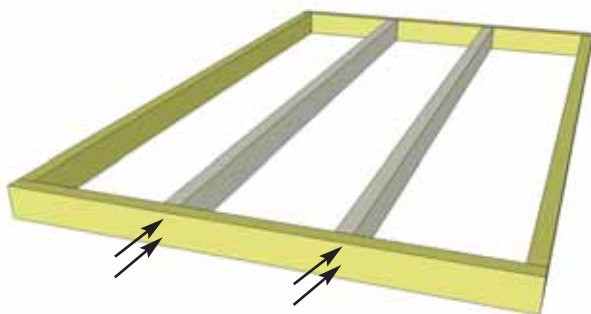

2. When correctly positioned, attach each Joist with 4 - 2 1/2" screws (2 per end). **You can find the Square Drive Screw Bit in the Hardware Kit Bag.**

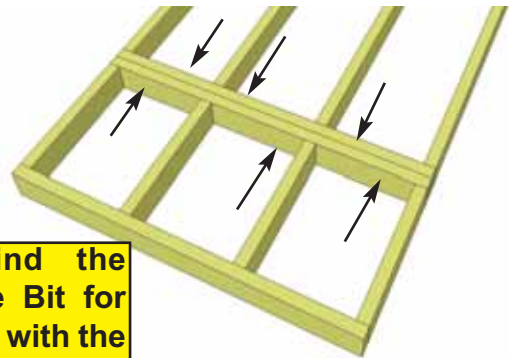
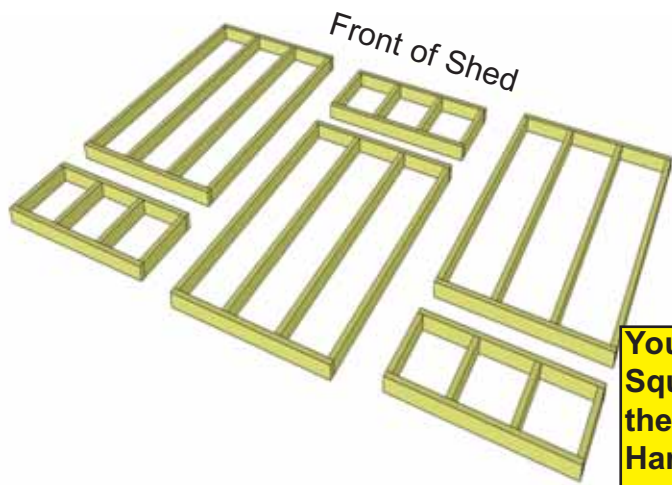

3. Lay out **Floor Joist Frames** as illustrated. There are 3 larger and 3 smaller Frame Sections. The Footprint for the floor when attached together will be 136 1/2" wide x 96" deep.

4. Attach each large and small floor joist frame together with 6 - 2.5" screws per section.

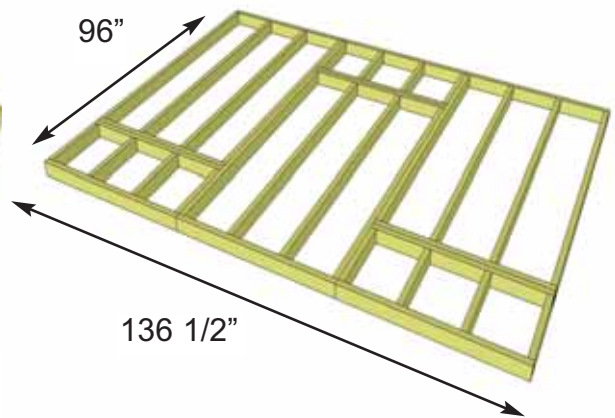

5. Complete all large and small frame attachments. Screw each completed section together with 8 - 2.5" screws.

6. When completed, your floor footprint should be 136 1/2" wide x 96" deep.

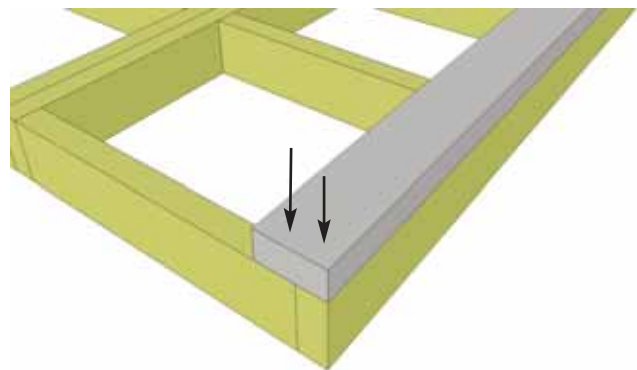
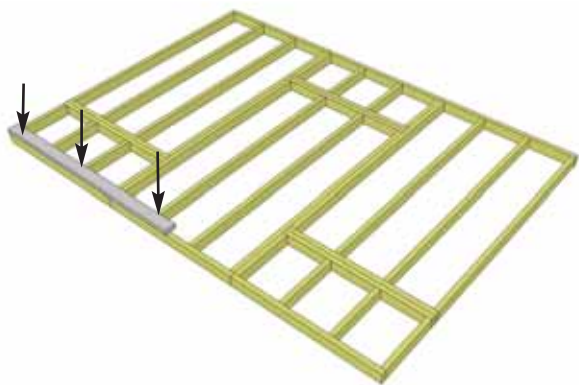

7. Attach **Floor Runners** to completed floor frame. There are 2 floor runners per 136 1/2" side and 5 completed runners in total. Use 6 - 2.5" screws per Runner.

8. Make sure Runners are flush with outside and front and rear floor framing but not overhanging.

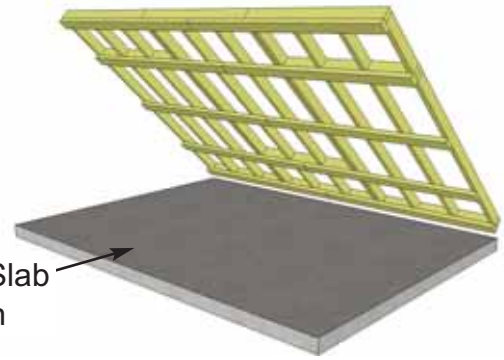

9. Complete remaining Floor Runners.

Foundations

Note: The floor will be flipped over and the floor runners will sit on your foundation. It is important to note, that having a level foundation is critical. Choosing a foundation will vary between regions. Typical foundations can be concrete pads or patio stones positioned underneath the floor runners.

10. With Floor Runners attached, carefully flip the floor over and place on your foundation. **Caution:** you will need 2 people to assist you. Be careful when laying floor down not to bend or twist floor. When in place, level floor completely.

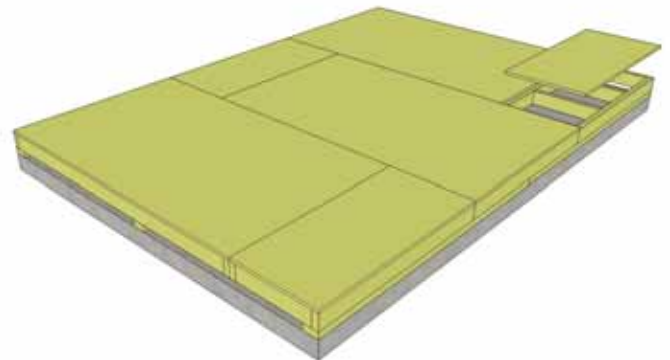
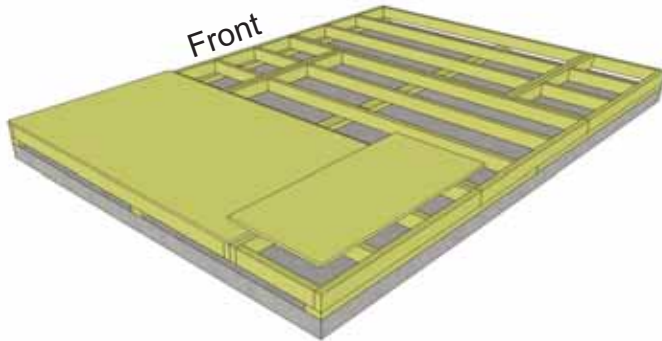
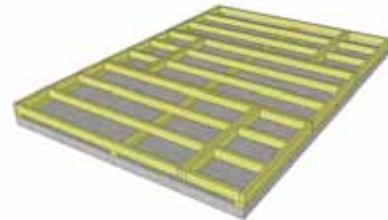

11. Position **Plywood Floor** pieces (6) on top of completed floor joists. Plywood will sit flush with outside of floor joist frame.

Hint: Use a chalk line to mark location of floor joists to determine screw placement.

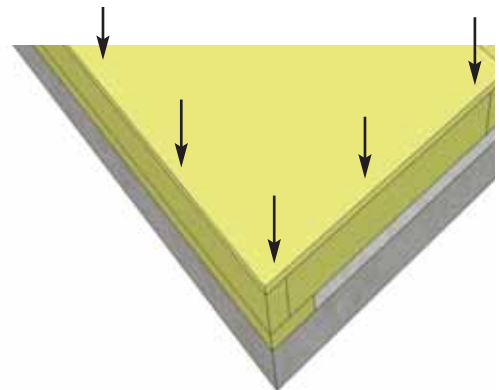
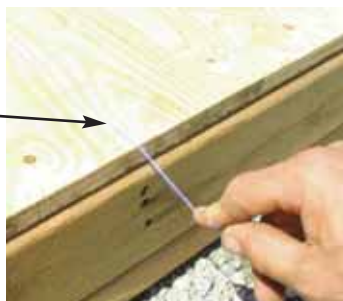

12. With Plywood positioned correctly on floor framing, attach with 1 1/4" screws. Use screws every 16".

B. Wall Section

Exploded view of all parts necessary to complete the Wall Section.
Identify all parts prior to starting.

Gable Walls
(4)

Front and
Rear Top
Plates (4)
Angle cut on edge

Window Wall
Panel (2)

Narrow Wall Panel
(12" wide)

Door Jamb

Door Header

Side Top
Plates (3)
2 Angle cut on 1
end and 1 square
cut.

Solid Wall
Panel (7)

Window Insert
(2)

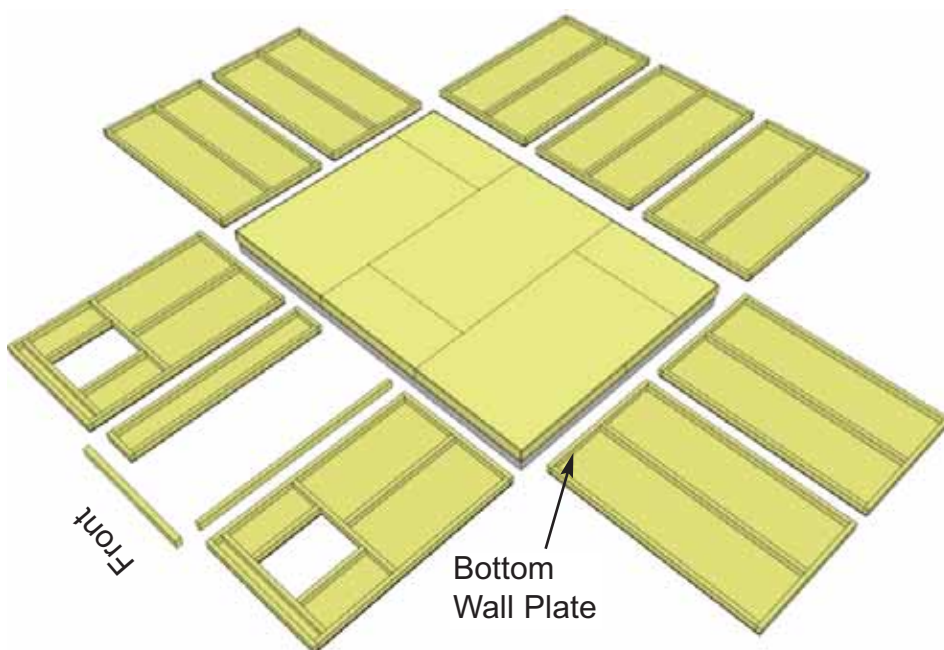

13. Lay out all the wall panels and become familiar with their location.

On Standard Kits, there are **2 Window Wall Panels, 7 Solid Wall Panels and 1 Narrow Wall Panel.**

Make sure to position panels right side up so water is directed away from and not into shed. Look at window wall panels to determine proper wall position to confirm.

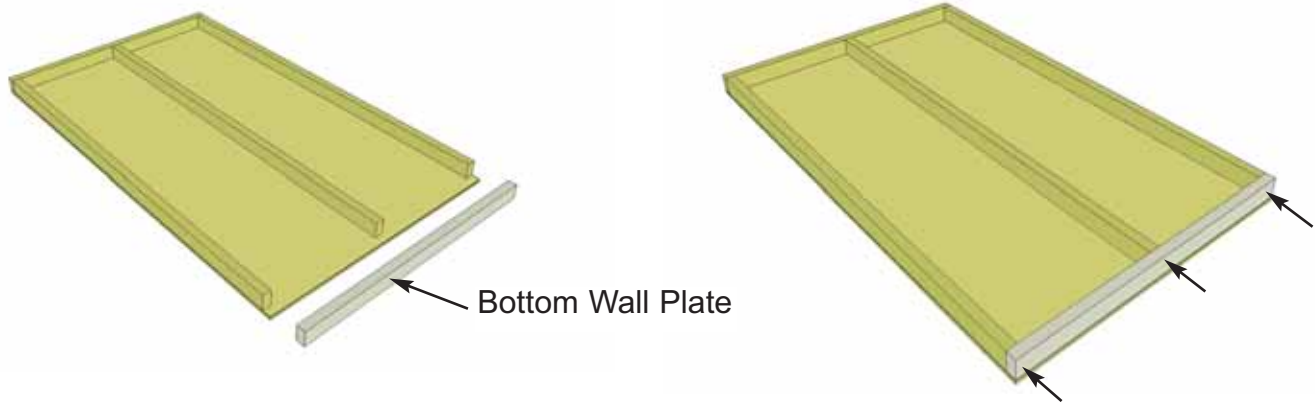

14. Starting with **Solid Wall Panels**, carefully lay panel face down. Position and attach **Wall Plate** to bottom of wall studs of each wall panel with 3 - 2 1/2" screws. Position so plates are flush with framing.

15. Starting at Rear Corner, position a Solid Wall Panel on top of plywood floor. The Wall Panel bottom framing will sit flush with plywood. Wall siding will overhang the floor.

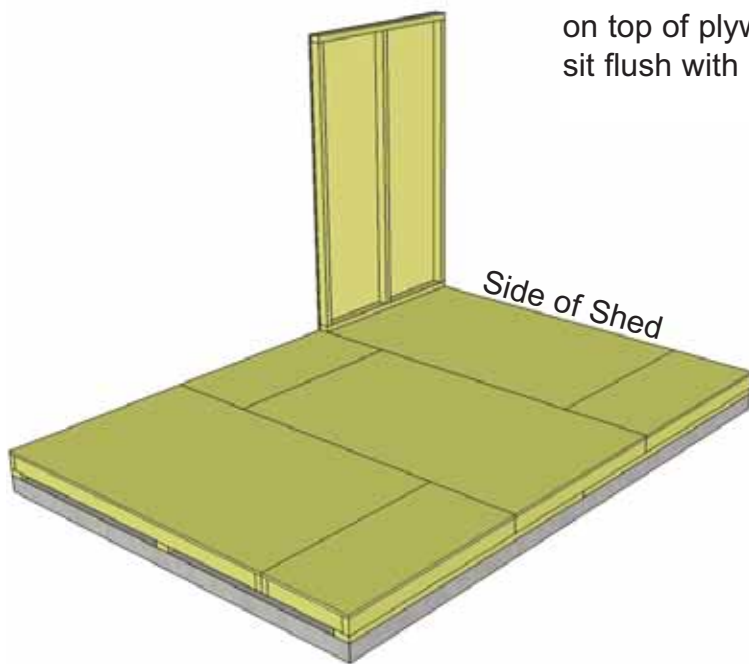

Important: Make sure all walls are aligned in their upright position. If not, water may leak into your shed. Unsure if panel is facing up or down? Check siding on window wall panel to match alignment.

16. The rear wall panels will sit flush at the end of the plywood floor with the sidewall panels sandwiched between them.

Note: Siding will overhang the floor by approximately 1/2".

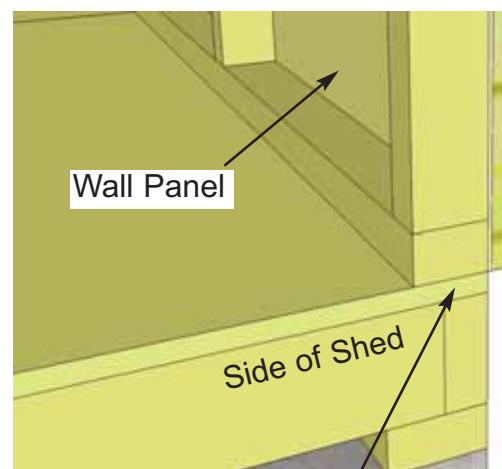

Outside 2x3 framing of wall panel is flush with outside of plywood when properly aligned.

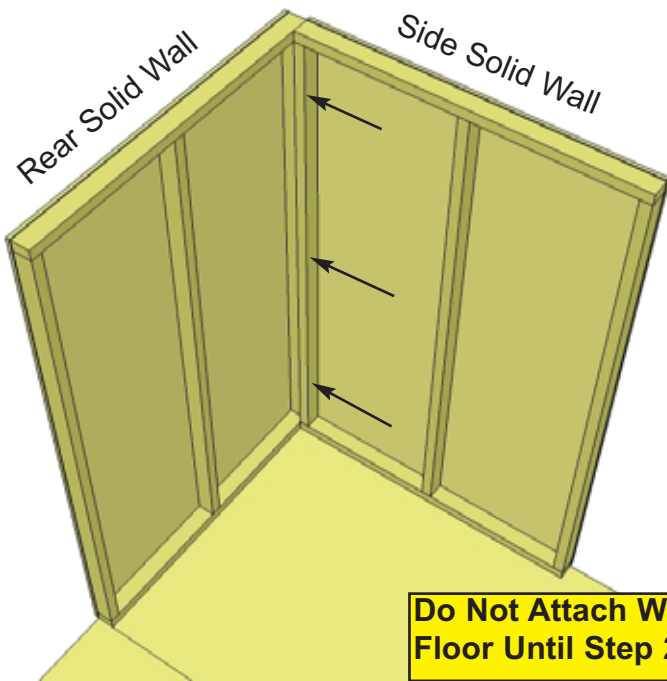

Optional - Caulking seams will help prevent moisture from entering at seam. **Caulking not included in kit.**

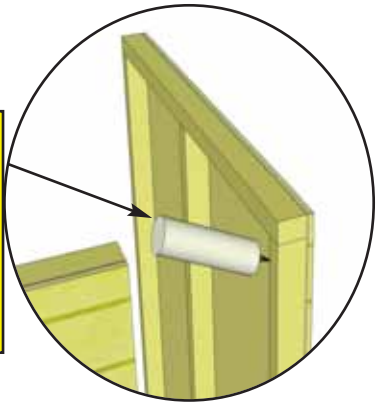

17. Position side solid wall into place on plywood floor. Butt both vertical wall studs of side and rear walls together and attach with 3 - 2.5" screws. Screw at the bottom, middle and top of stud to secure properly.

Do Not Attach Walls To Floor Until Step 26

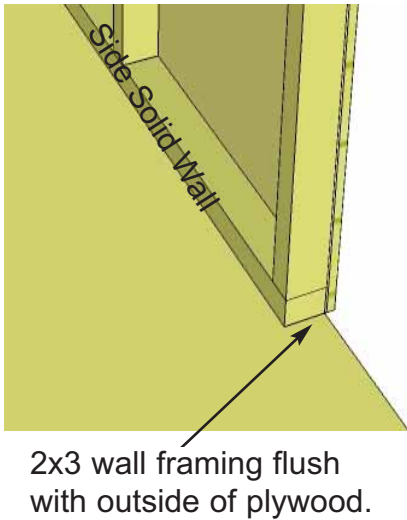

18. With the corner wall attachment complete, position a second side wall panel in place so bottom 2x3 wall framing is sitting flush with outside floor joists and plywood floor. Wall siding should overhang floor by approximately 1/2". When positioned correctly, attach both side wall panel studs together as per **Step 17**.

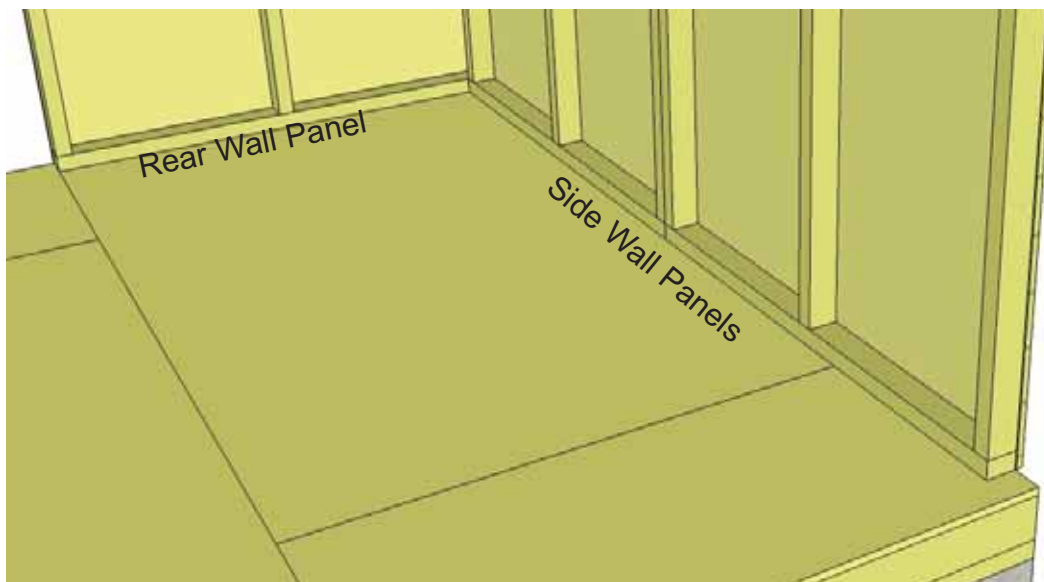
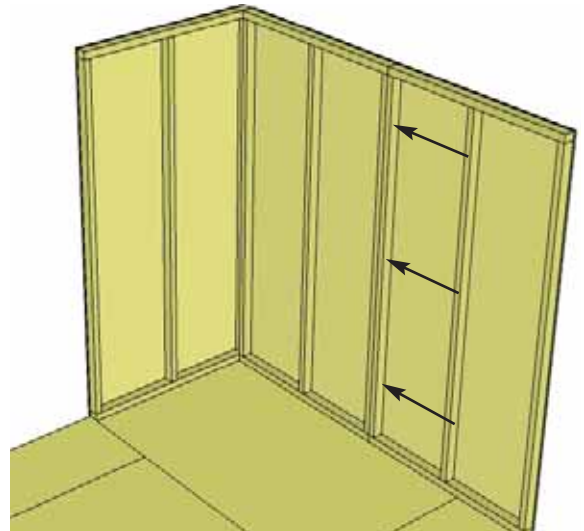

Be sure that rear wall panels fit between the side wall panels (sandwiched).

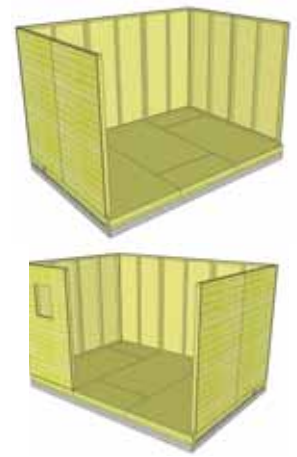
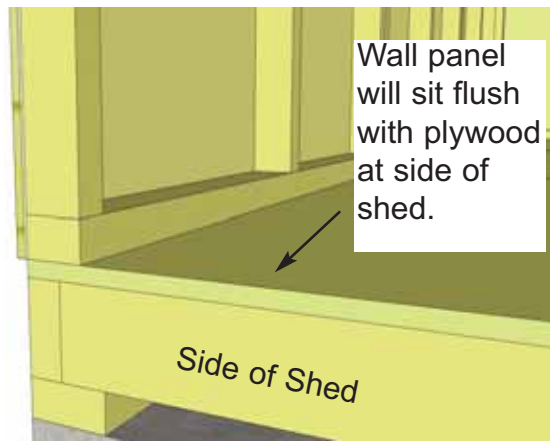
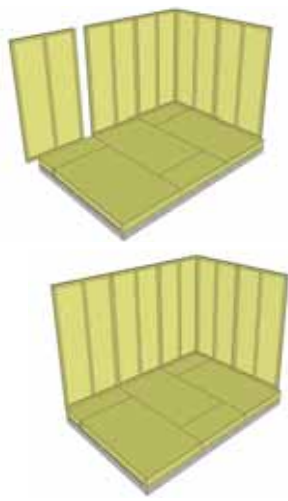

19. Complete all side and rear wall attachments. Place Window Wall Panel in front and attach as per Step 17.

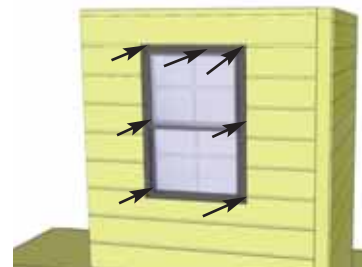
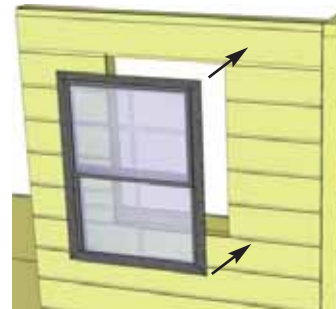
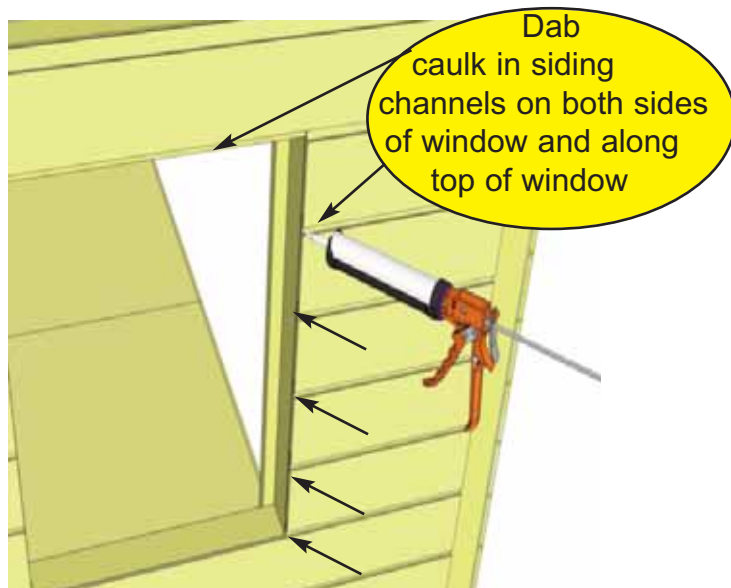

20. Locate **Window Inserts for Window Walls**. Before installing, dab caulk in siding channel on both sides and across top of window opening. This will prevent water from getting in behind window. Position window in cavity and secure with 8 - 1 1/4" screws. Window Trims in Step 21 will be installed to hide caulking. Complete Window Inserts as walls are erected or completed..

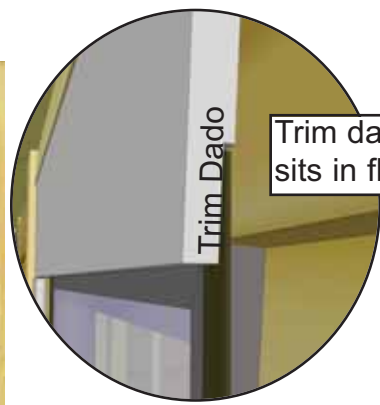

Trim dado sits in flange.



21. Position Window Trim around window doing a dry run first and attach with 4 - 1 1/2" finishing nails per piece. The window kit trim pack = 1x 24 1/16" = top / 3 x 23"= sides and bottom. Window trim has a small dado on reverse face. Outside flange of window will roughly sit in the dado to give a better fit.

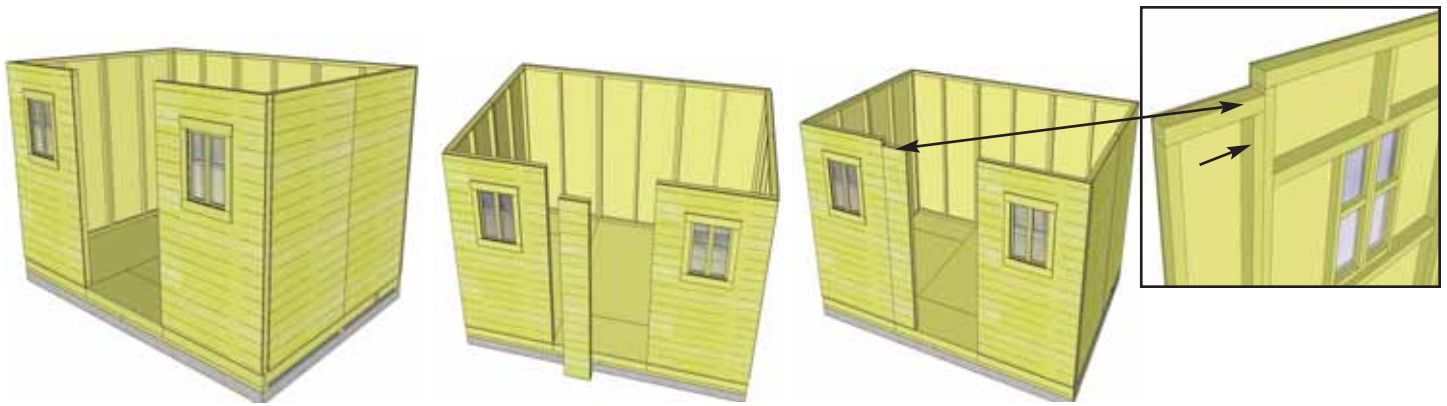

22. Place 2nd Window Wall Panel in front and attach. Insert 2nd Window Insert as per **Step 20-21**.

23. Position and attach Narrow Wall Panel to left side wall stud with 3 - 2.5" screws as per **Step 17**. **Note:** Narrow Walls are 73" high (2" shorter than wide walls).

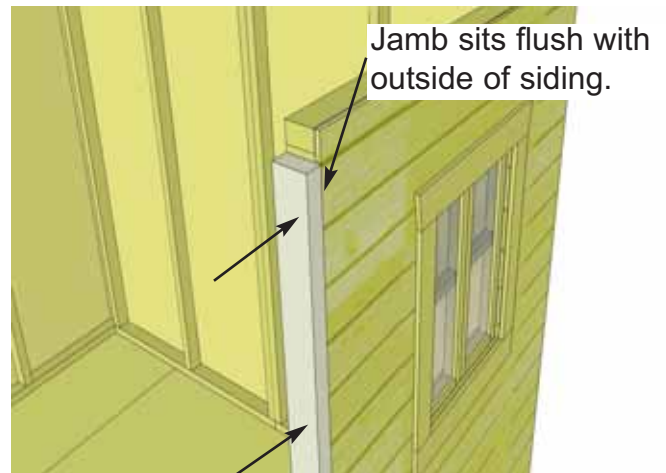
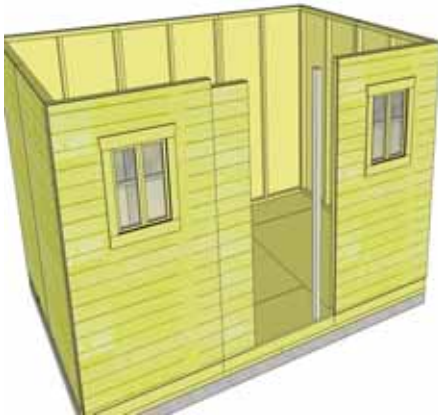

24. Locate Vertical Door Jamb and position flush against right wall panel stud. The Jamb is 3" wide and will sit flush to outside of wall siding. When positioned correctly, secure Jamb using 4 - 2.5" screws.

Dado cut on edge aligned to top and facing the front.

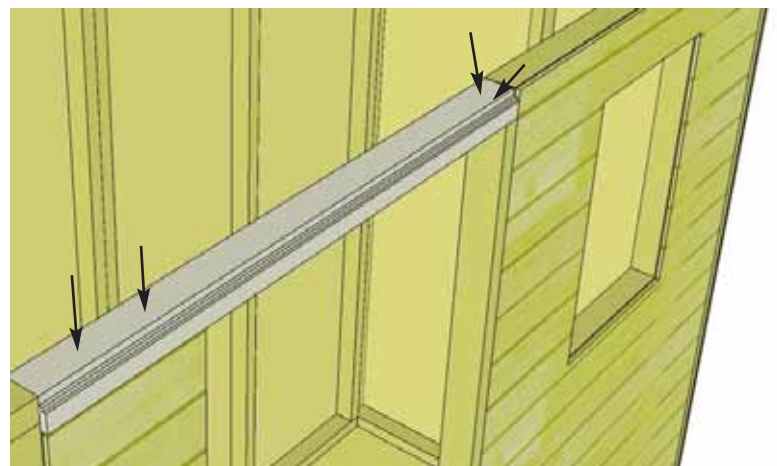
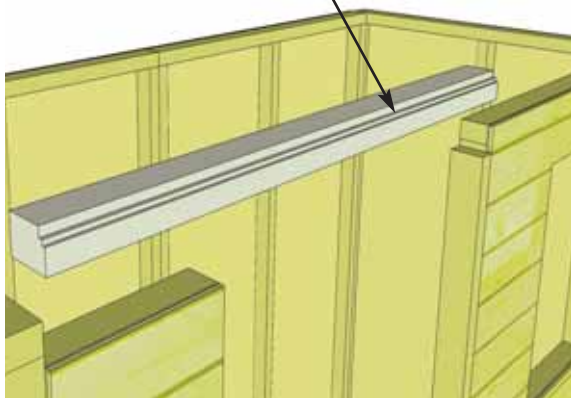

25. Position and attach the Door Header to Door Jamb and Narrow Wall Panel top framing. Header should sit flush with Door Jamb and Outside of Narrow Wall Panel Siding. Attach with 4 - 2 1/2" screws.

26. When all walls are attached together, check alignment with the floor. Bottom wall framing should sit flush with outside of floor joists and plywood floor. Confirm 32" wide door opening at bottom. When positioned correctly, fasten bottom wall plates to floor using 4 - 2 1/2" screws per wall panel.

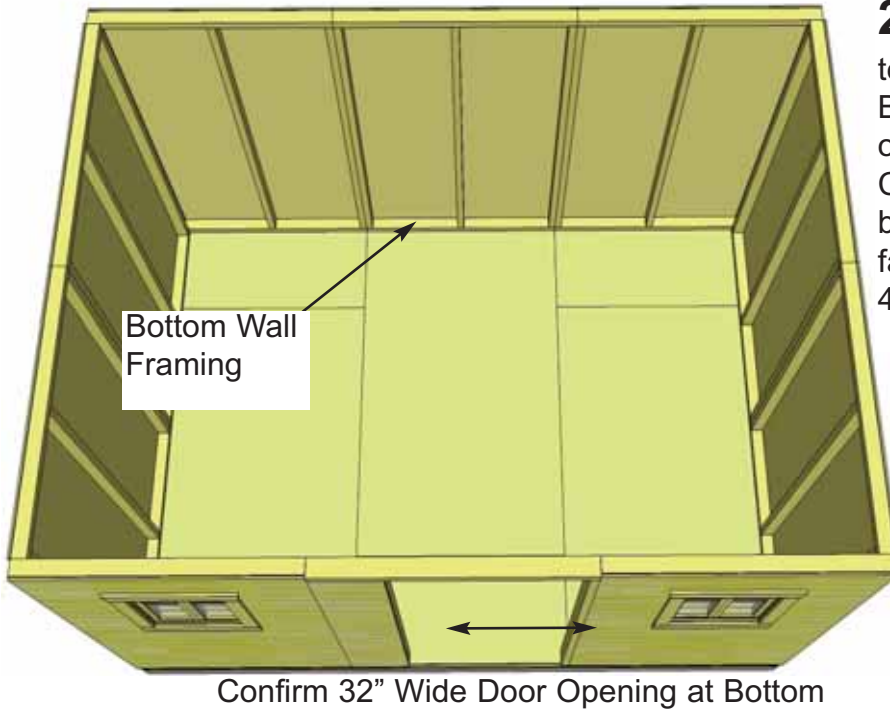

Optional - Caulking seams will help prevent moisture from entering at seam. **Caulking not included in kit.**

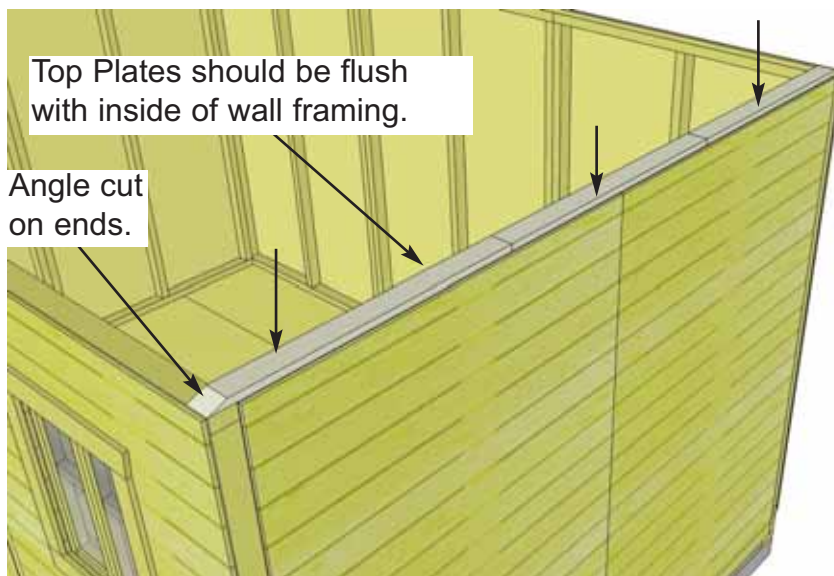
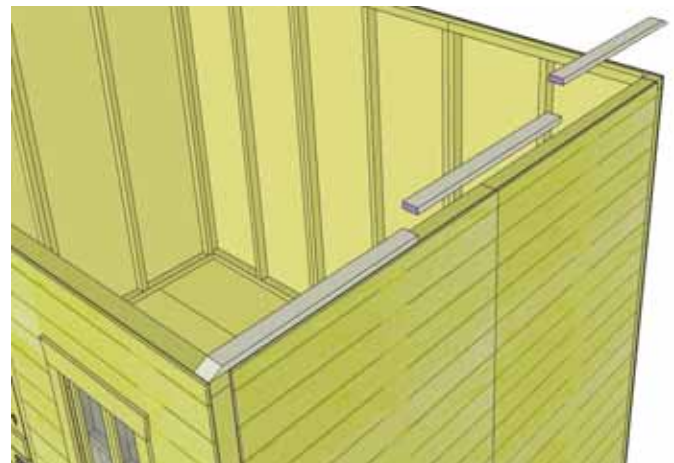
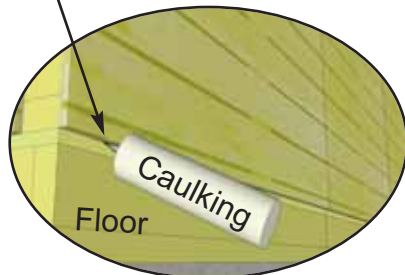

27. Position **Side Top Plates** (one side only) on top of wall studs so they are flush on the inside with 2x3 wall stud. There are 3 pieces of Side Top Plates (2 angle cut on one end and one straight cut - both ends). Together, the plates should be centered evenly on the wall left to right. Attach by screwing down into top wall framing with 4 - 2" screws per plate.

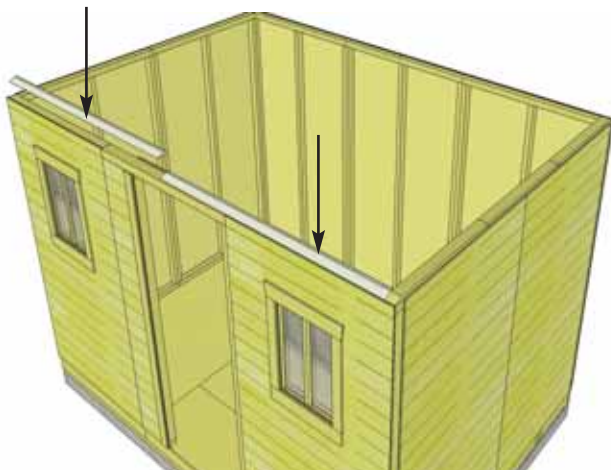

28. Next, attach the 4 Front and Rear Top Plates (2 per side). The Front and Rear top plates are angle cut down the Edge. Once again, position top plate on wall plate so it is flush with inside of wall plate. Secure with 4 - 2" screws per piece.

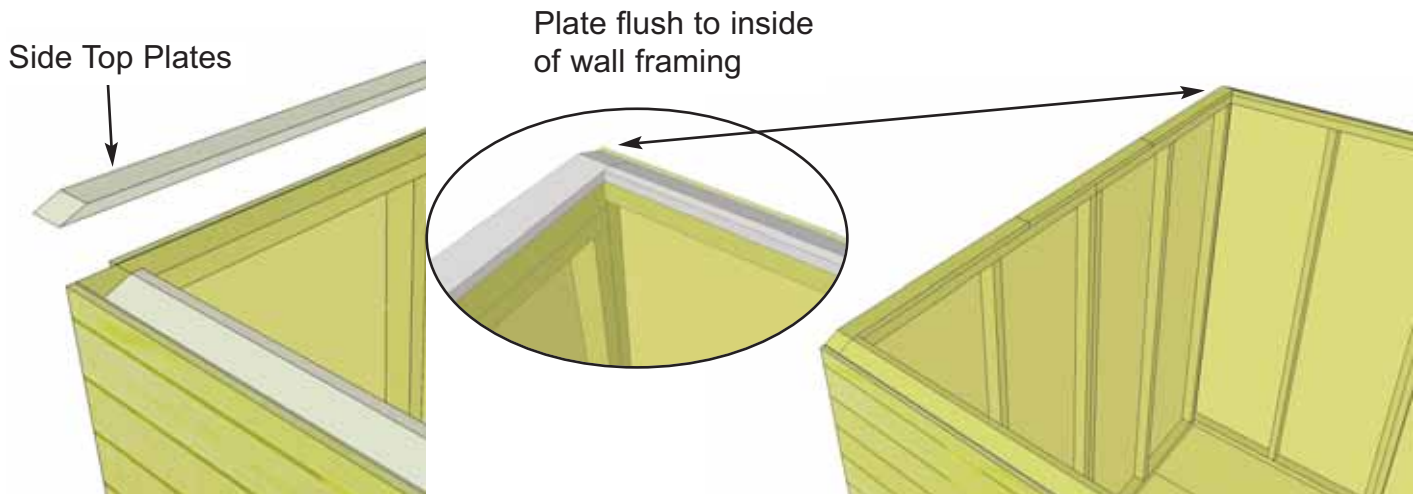

29. Position Side Top Plates on other side wall top framing to complete. Use 4 - 2" screws per piece.

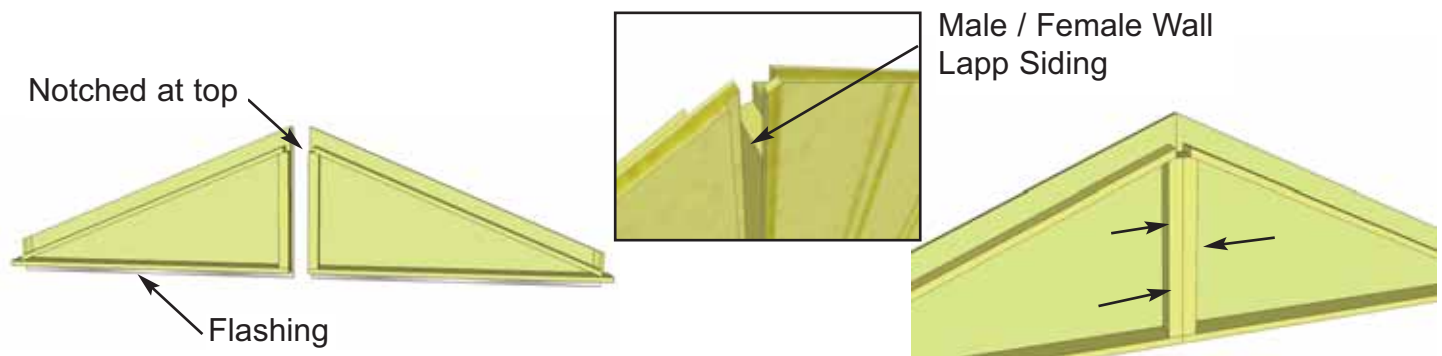

30. Locate Gable 1/2 Walls for both sides of the shed. Align framing and wall siding lapp together. Screw center wall framing of each piece together with 3 - 2 1/2" screws. **Note:** prior to attaching, try each combination of Gables for best fit.

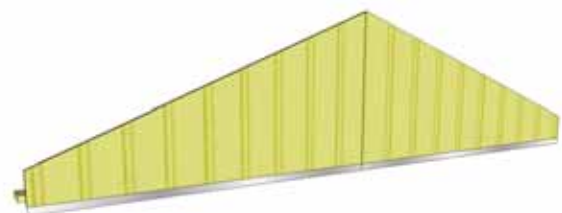

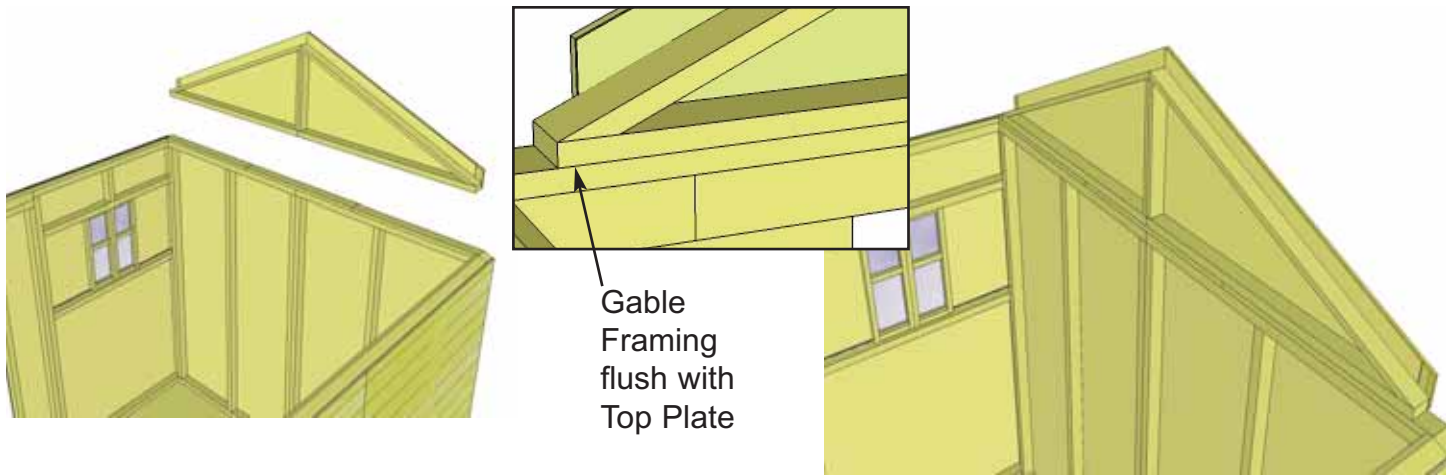

31. Lift up a completed gable section and place on top of Side Top Plate on wall. The gable framing should sit flush with the inside of the top plate.

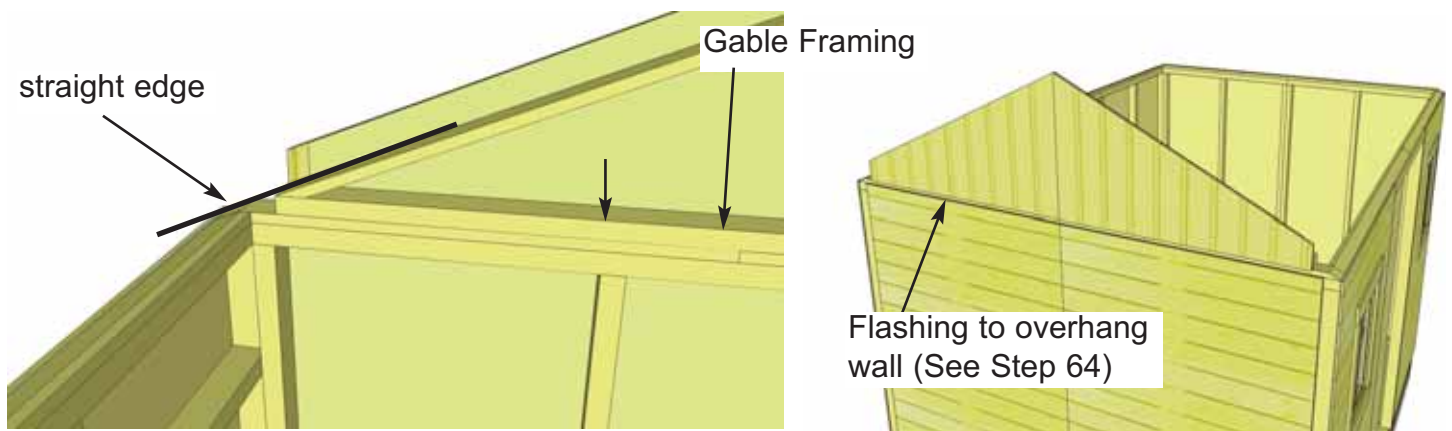

32. The gable should be centered sideways (left to right) on the top plate. **Hint:** use a straight edge to check the angle of the gable framing and top plate. Both angles should line up. Adjust gable accordingly. Temporarily attach to walls and top plate with 2 - 2" screws. Gables may need slight adjustment in **Step 43**. Complete attachment in **Step 43** with 6 additional screws.. Screw from the bottom of gable framing down into Top Plate and Wall.

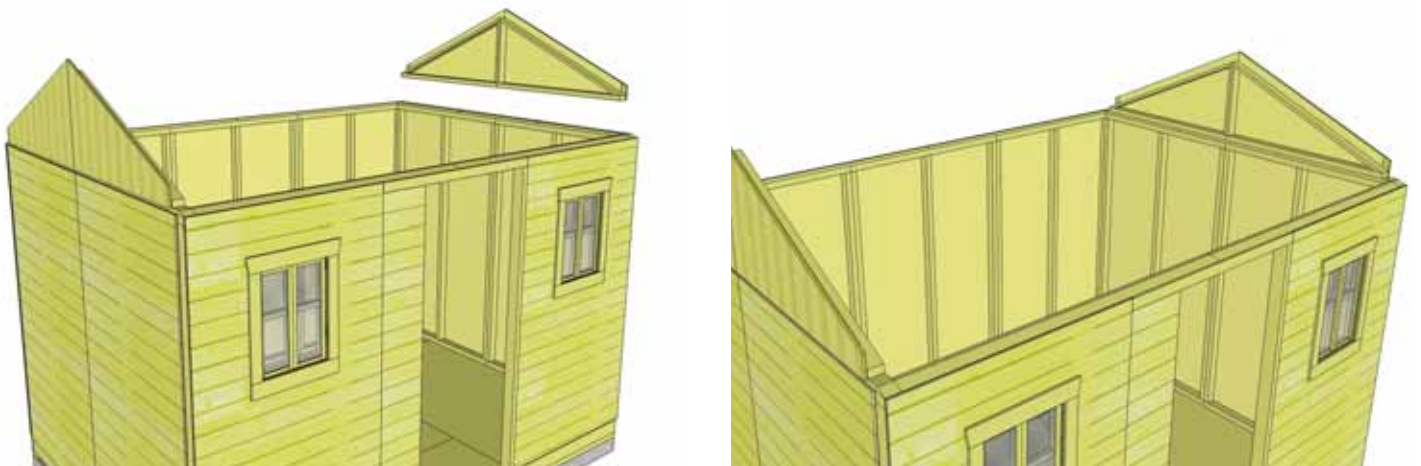

33. Complete positioning and attachment of Side Gable as per **Step 32**.

C. & D. Rafter and Roof Section

Exploded view of all parts necessary to complete the Roof Section.
Identify all parts prior to starting. (Roof Filler Shingles Missing)

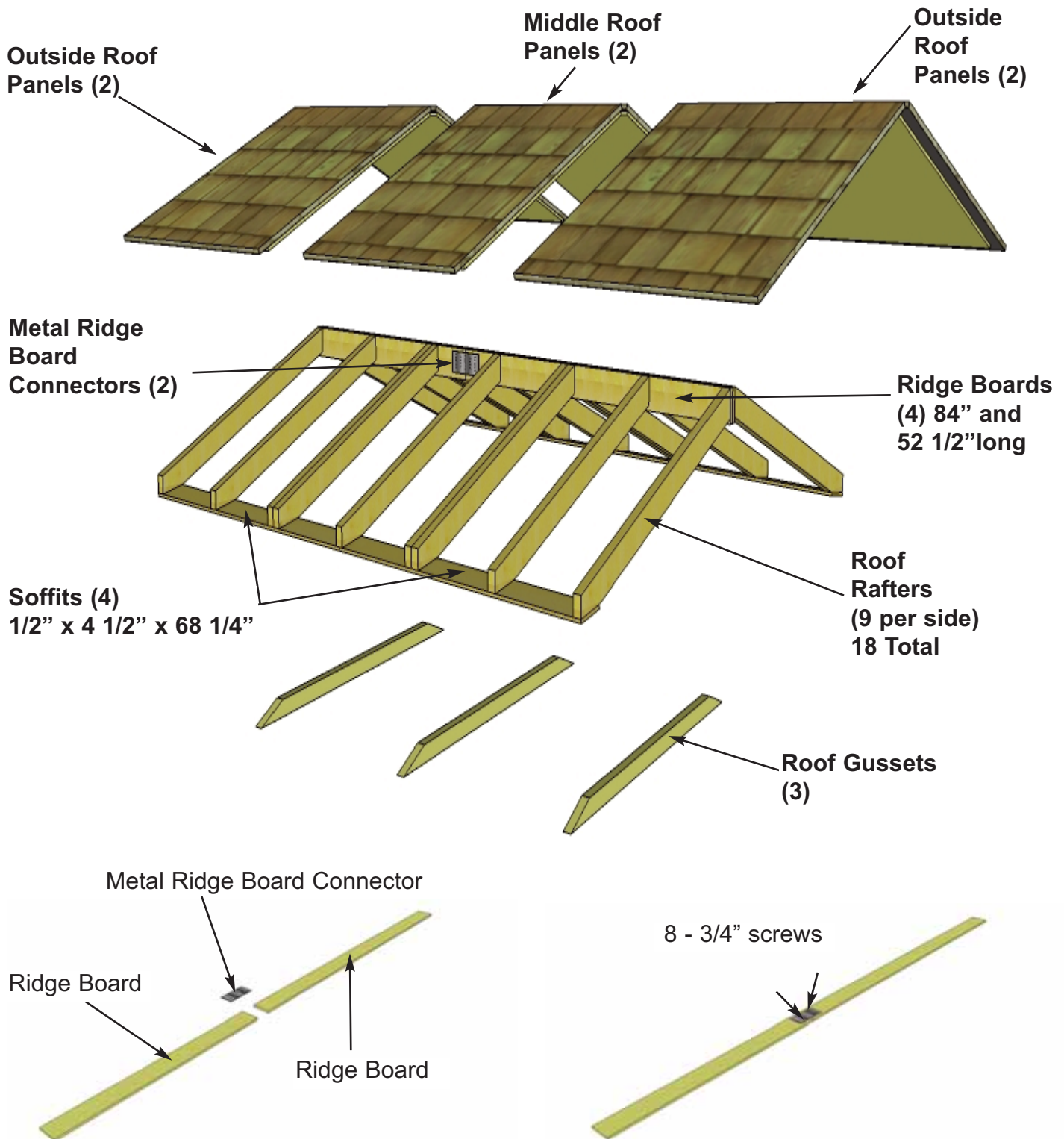

34. Locate (1 each) 3/4" x 4 1/2" x 84" & 52 1/2" **Ridge Boards** and attach together with **Metal Ridge Board Connector** using 8 - 3/4" screws. Total Length when connected is 136 1/2". Complete two Sets. Position Metal Ridge Board Connector evenly on Ridge Boards.

35. Locate 9 **Rafters**, 2 **Soffits** and completed Ridge Board. Lay out on level ground as shown to the right. Double up Rafters as illustrated. Screw doubled up Rafters together with 3 - 2 1/2" screws per piece. **Note:** completed rafter section will be flipped over in **Step 38**.

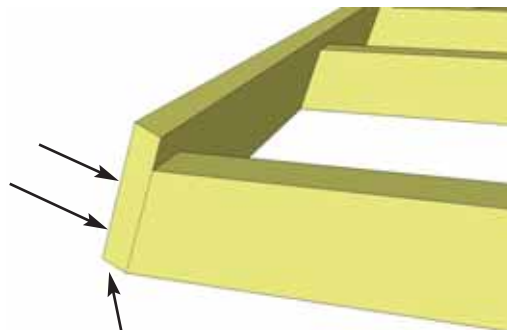
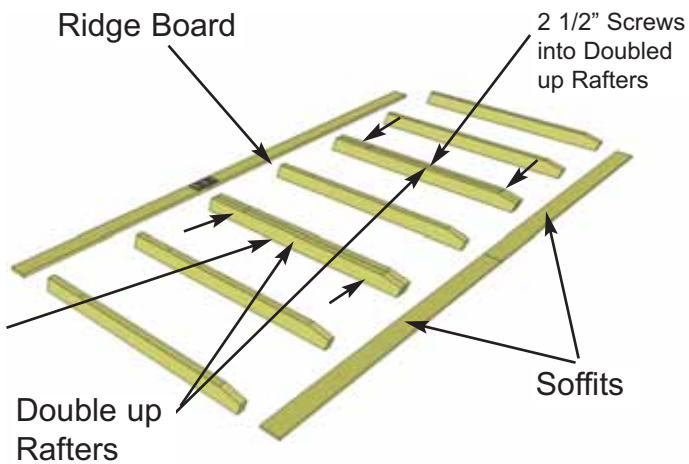

Important:
Pilot Hole Ridge Board to prevent splitting!

36. Attach completed Ridge Board to ends of both outside rafters with 2 - 2" screws per end. Measure and position interior Rafters as illustrated below. When positioned correctly, attach Ridge Board to remaining rafters with 2 - 2" screws /rafter end.

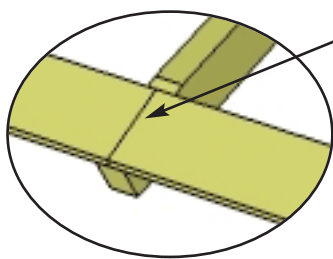
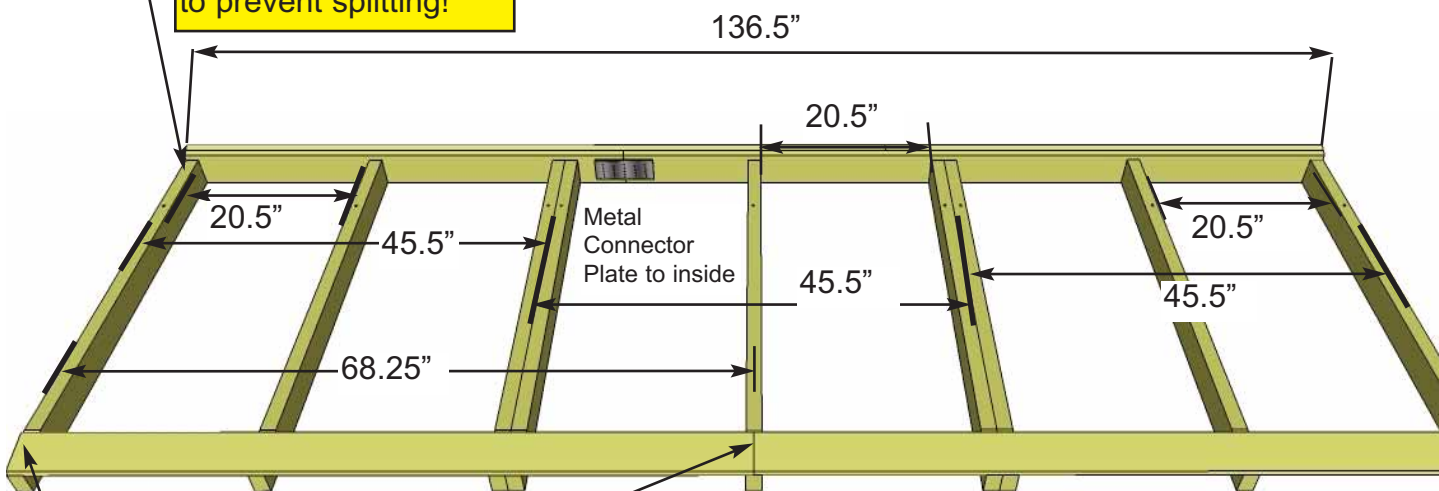

Important: Pilot Hole Soffit to prevent splitting!

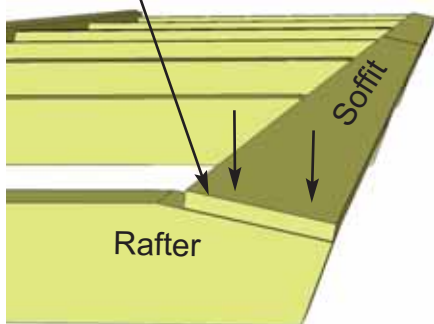

37. Attach end of a 68 1/4" long Soffit Board flush to ends of outside rafters with 2 - 1 1/4" screws per rafter end. Drill pilot hole in Soffit ends to prevent splitting. Complete both outside rafter / Soffit connections first. Measure and position interior Rafters as illustrated above. When positioned correctly, attach Soffits to remaining rafters with 2 - 1 1/4" screws /rafter. Flip completed rafter section over. Complete 2nd Rafter section now as per **Steps 34 - 36** with the following exception - **When attaching Ridge Board to Rafter ends, make sure Metal Ridge Board Connector is positioned so offset to first Rafter Section. See Step 42 for illustration.**



Flip completed Rafter Sections over before lifting on to Gables.

38. Starting with the rear Side, lift completed rafter section up. **Note: Soffit must be facing down.**

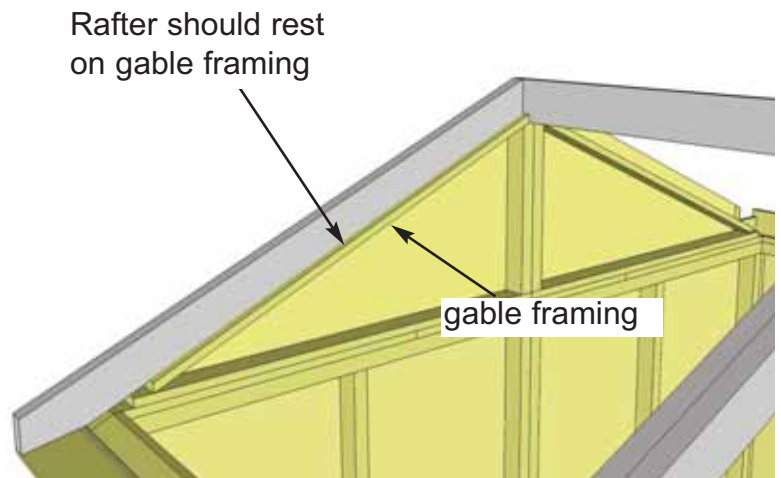
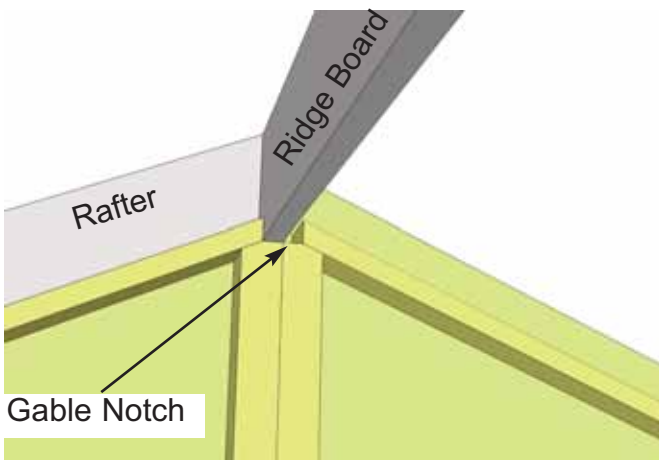

39. Slide Rafter Section up on gable framing until bottom of Ridge Board slips into gable notch.

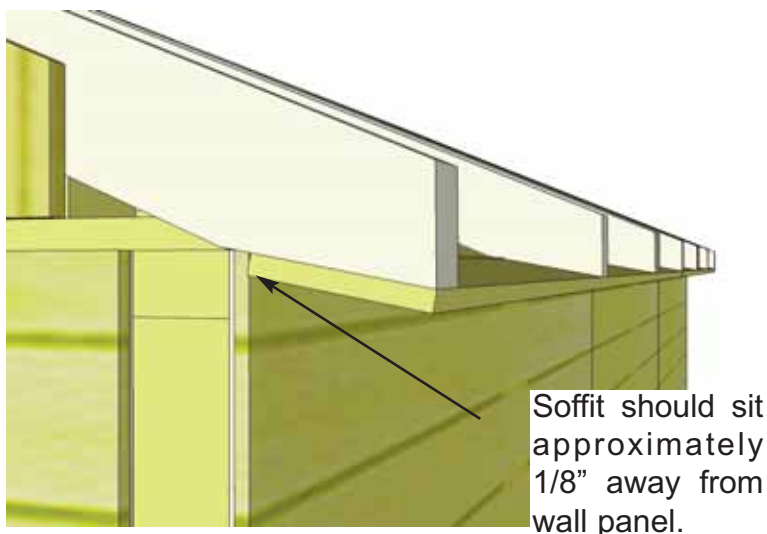

40. When Rafter Section is correctly positioned, outside rafters will sit equally on gable framing and Soffit will sit approximately 1/8" away from wall panels.

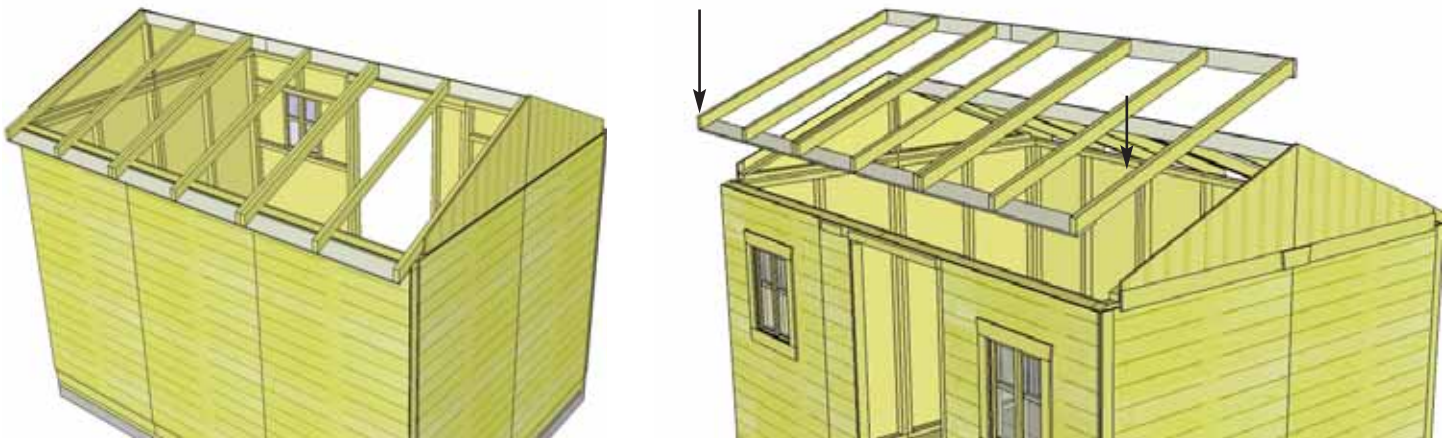

41. Place 2nd completed Rafter Section on gable wall framing. Position as per **Steps 39 & 40.**

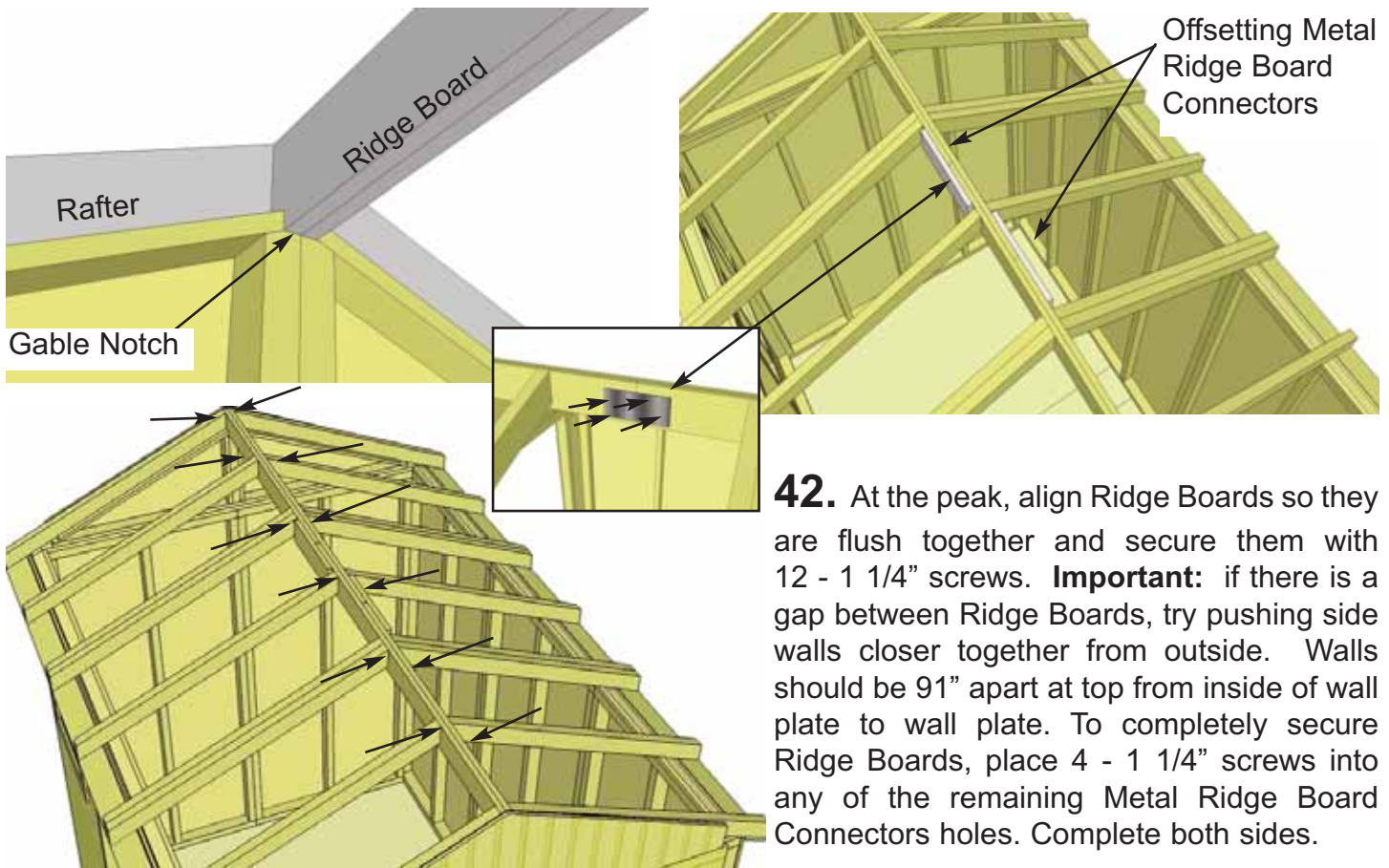

42. At the peak, align Ridge Boards so they are flush together and secure them with 12 - 1 1/4" screws. **Important:** if there is a gap between Ridge Boards, try pushing side walls closer together from outside. Walls should be 91" apart at top from inside of wall plate to wall plate. To completely secure Ridge Boards, place 4 - 1 1/4" screws into any of the remaining Metal Ridge Board Connectors holes. Complete both sides.

43. With both Rafter Ridge Boards connected. Completely secure Gable framing to both outside rafters with 8 - 2" screws per gable side.

Important: If Gable framing does not line up with Rafters, remove temporary 2" screws from gable framing. Re-align gable and secure with 8 - 2" screws total.

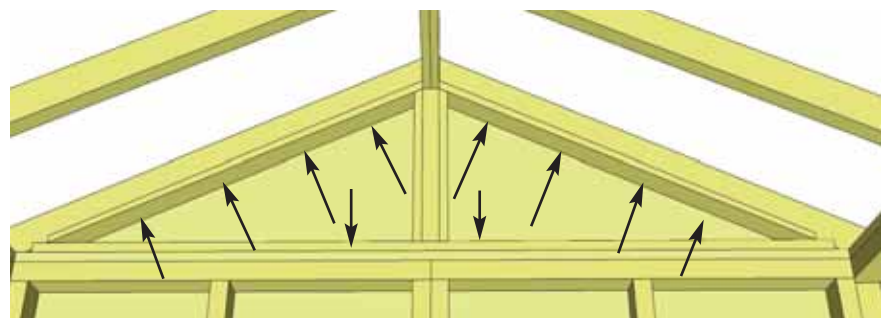

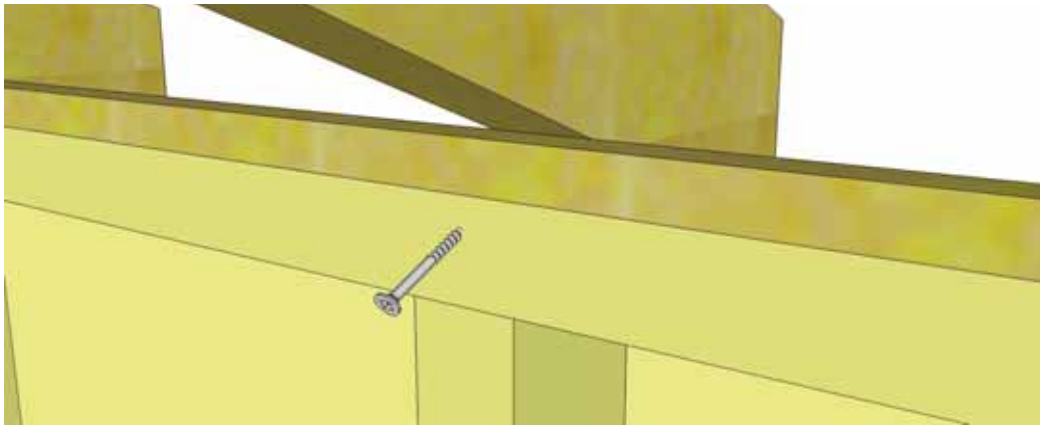

44. Secure Rafters to Top Wall Framing with 1 - 3" screw per rafter (excluding rafters sitting on gable framing). Screw through Wall Frame at an angle. Prior to attaching, make sure front and rear walls are properly aligned. Have two helpers push the front and rear walls at the top from the outside of shed until inside to inside measurement between front and rear plates is 91".

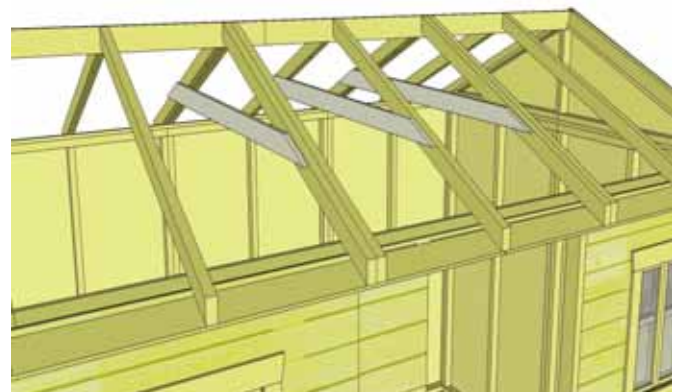
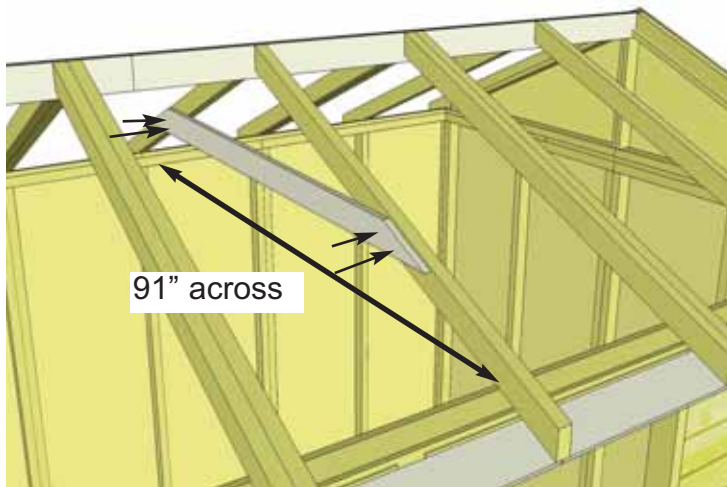

45. Roof Gussets are positioned on middle rafters. When correctly positioned, slide gusset up, using a level to square, and attach to rafters with 4 - 2" screws. Complete remaining Gussets.

Shingles overhang plywood on outside panels.

Roof facing down with roofing felt showing.

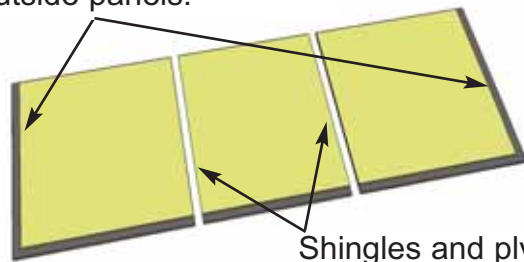

Shingles and plywood flush on middle panel.

Outside Roof Panel.



46. Identify Roof Panels. There are 2 Outside and 1 Middle Roof Panel per side. Starting with outside rear panel, lift up and place on rafters.

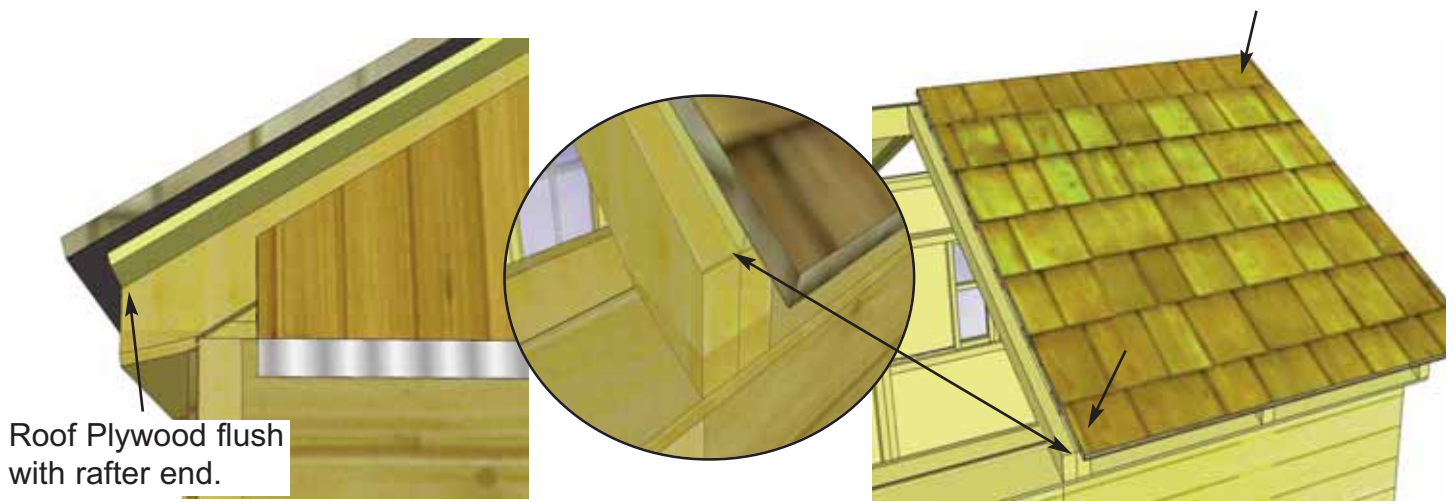

47. Place Outside Roof Panel so it sits flush on 3rd rafter from the outside (doubled up rafter). End of plywood should be flush with end of rafter at bottom. From the outside, screw down through bottom and top row of shingles into rafter with 2 - 2.5" screw.

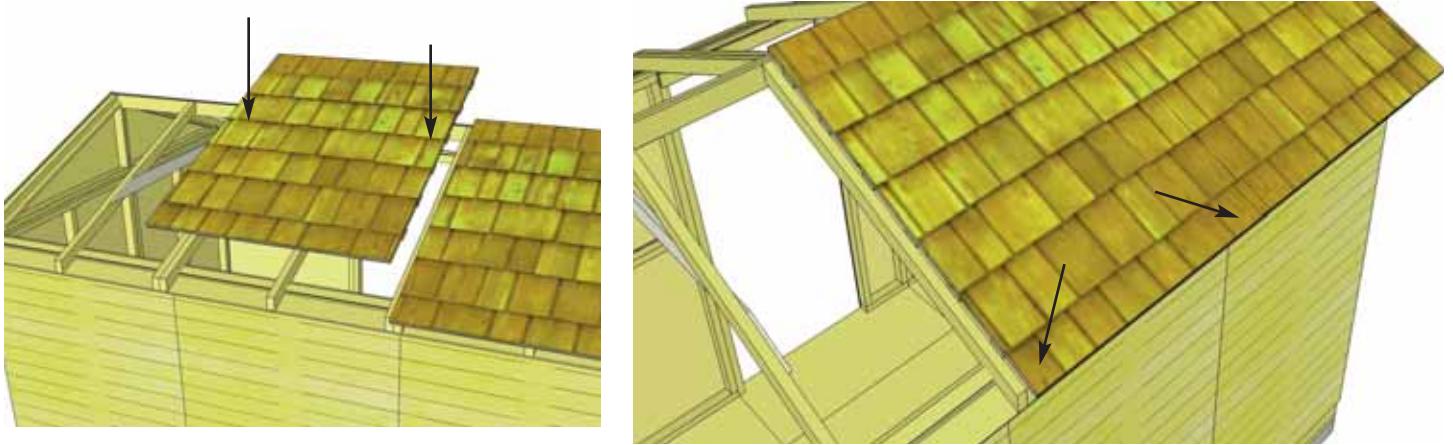

48. Locate Middle Roof Panel and place on middle rafters. With Middle Roof Panel aligned as per **Step 46**, tack panel down to rafters with 2 - 2.5" screws in the bottom row of shingles.



49. Lift up, position and attach 2nd Outside Roof Panel to Rafters as per **Step 46**.

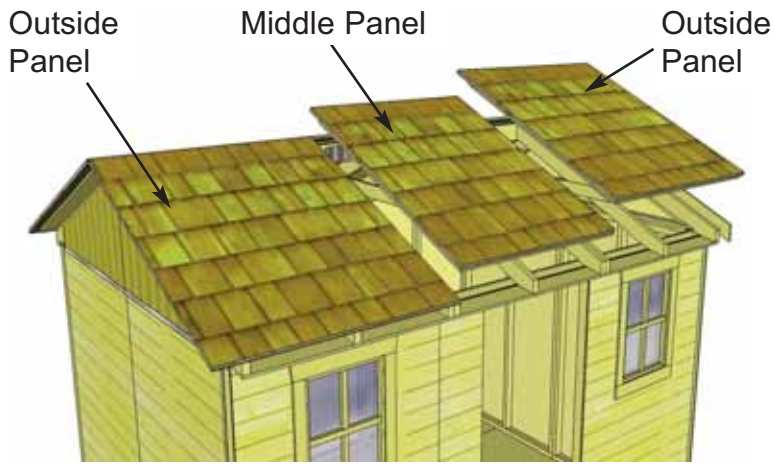

50. Position and attach Front Roof Panels as per **Steps 46-49.**



51. With Front Roof Panels positioned correctly, tack down as per **Steps 46-49.**



52. Roof **Filler Shingles** are included to cover roof seams. Starting at the bottom, slide the first Long Shingle in until flush with other bottom shingles. **Do not attach below exposure line (see diagram, step 53).**



Attach above the exposure line.
Exposure Line

53. Screw first filler shingle down to rafters using 1 - 2 1/2" screw per panel (2 in total). Make sure to screw into both rafters.

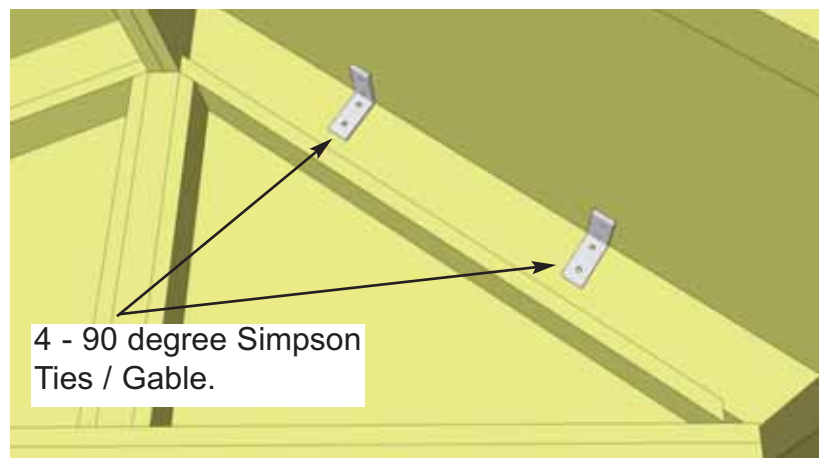

4 - 90 degree Simpson Ties / Gable.

54. Slide in another filler shingle and attach as per **Step 53.** On your last row of Filler Shingles, the shingle is precut to fit properly. Attach to roof with 2 - 1 1/2" Shingle nails per shingle. Position 2 Simpson Strong ties on plywood and outside rafters and secure with 4 - 1 1/4" screws. 8 ties in total.

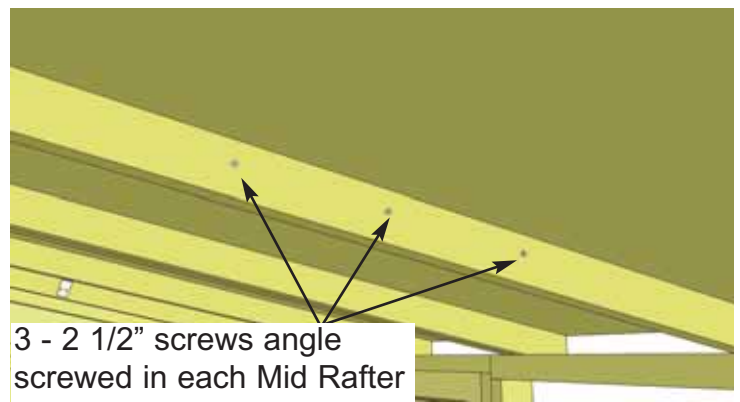
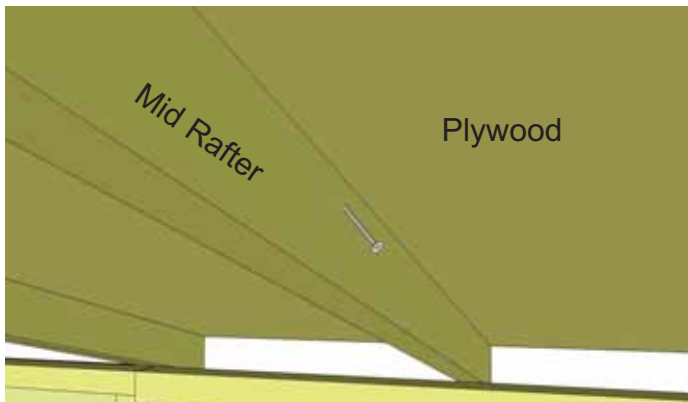

55. To further secure roof panels, from the inside, drill pilot holes in each Mid Rafter (3 per Rafter) on an angle. Using 3 - 2 1/2" screws, secure rafters to roof plywood. **Note:** from outside, have a helper push roof panel down so plywood sits flush against rafter when securing.

E. Miscellaneous Section

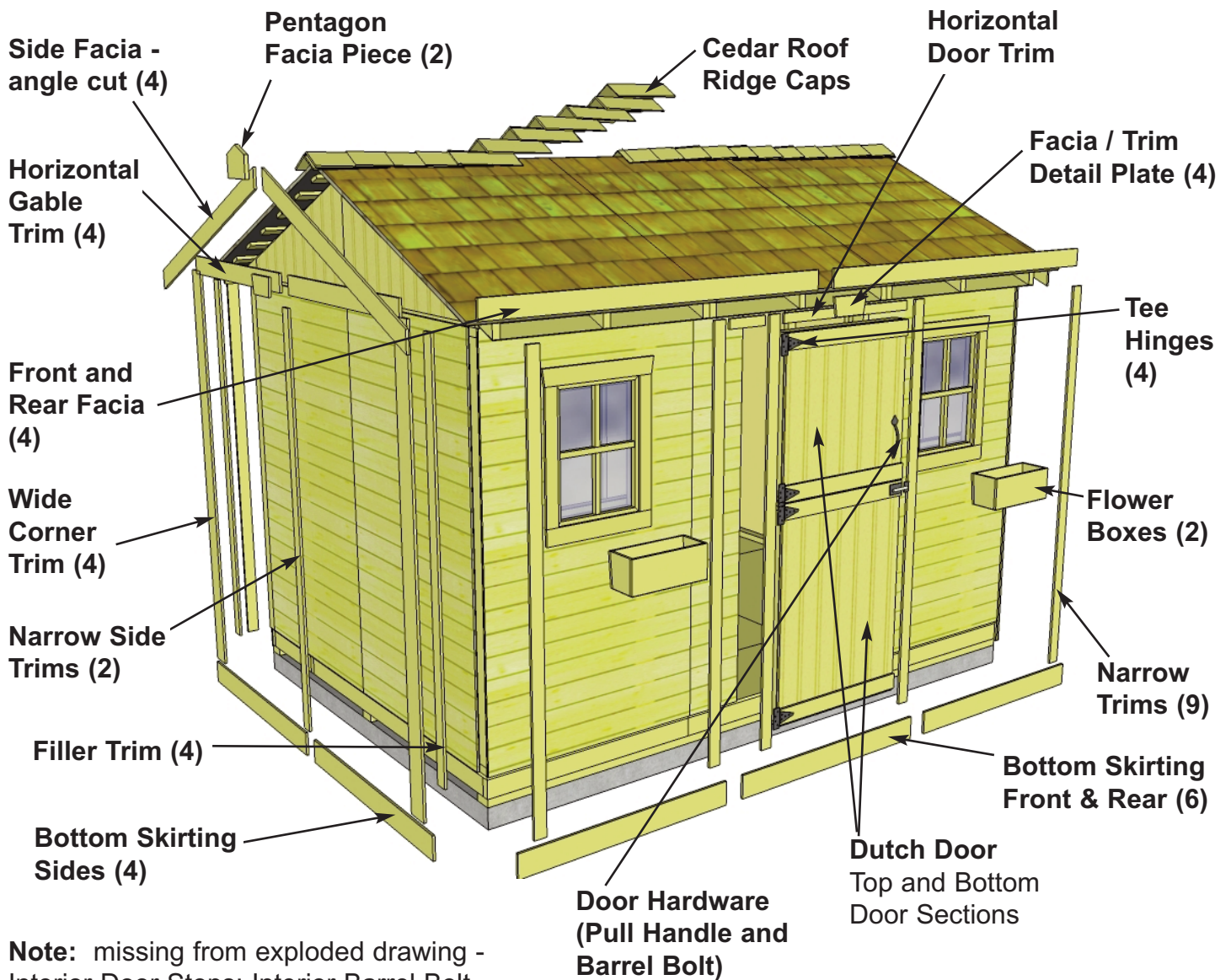

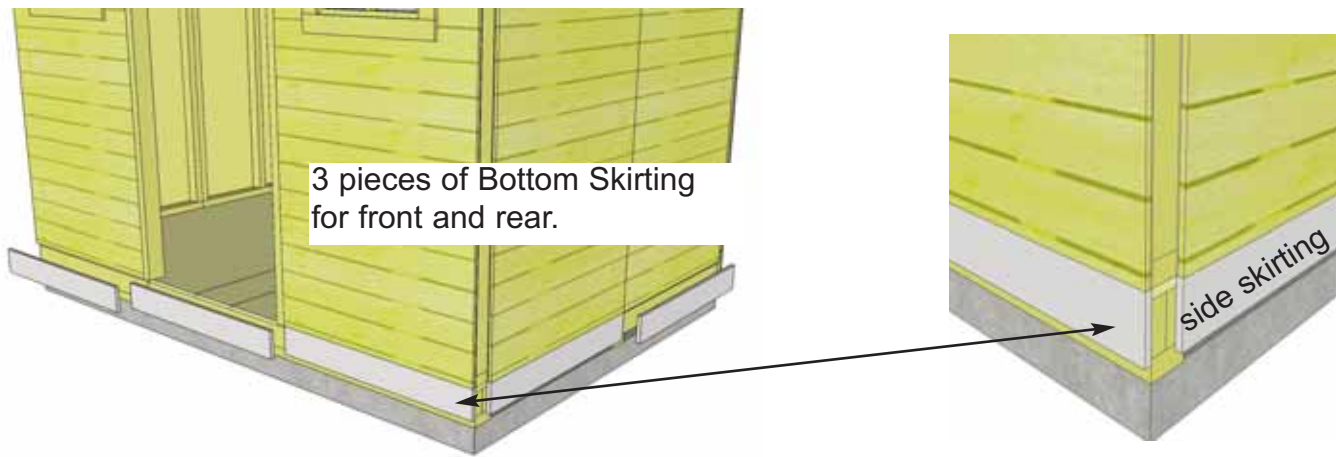

3 pieces of Bottom Skirting for front and rear.

side skirting

56. Attach **Bottom Skirting** around the base of the shed. Skirting will hide floor framing. The side skirting pieces will meet together in the center. Gaps on outside will be covered by Wide Trim pieces later. Start with front and rear skirting pieces first and attach with 4 - 1 1/2" finishing nails per piece.

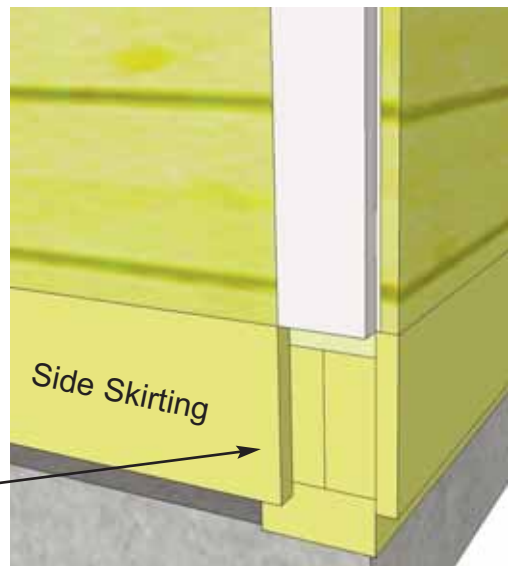
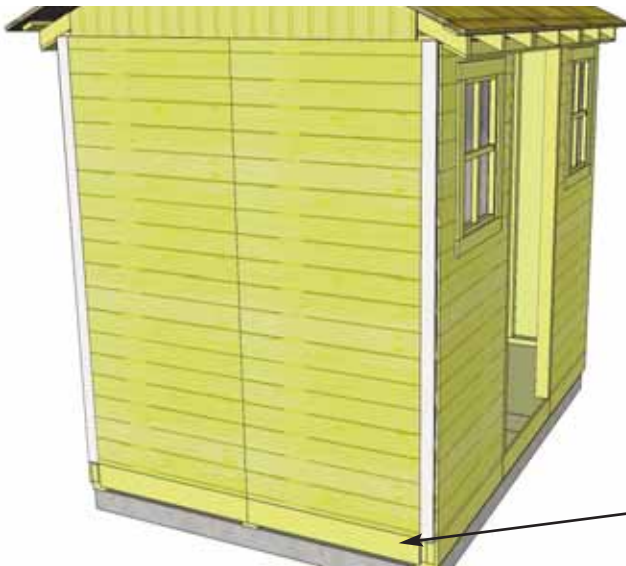

57. Attach **Filler Trims** (nailing strips) - 4 - 1/2" x 2 1/2" x 75" to each corner side wall. Align Filler Trims so they sit flush with top of Bottom Skirting. Hammer with 8 - 1 1/2" finishing nails per trim.

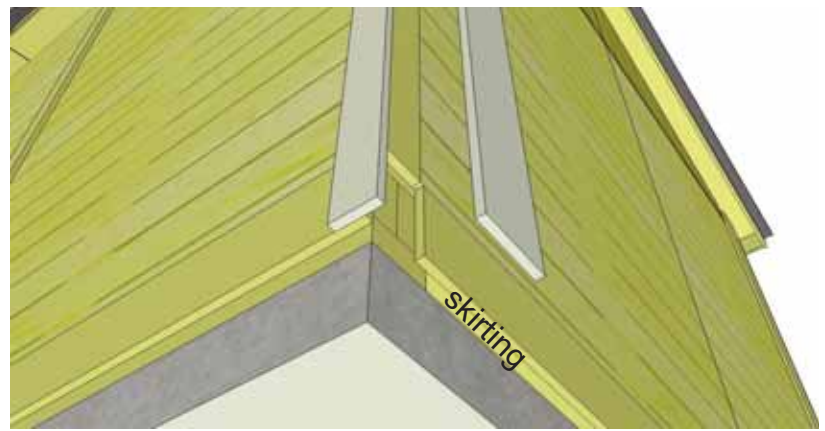

58. Attach **Wide Corner Trim** and **Narrow Corner Trim** in each corner. Wide Trims are 4 1/2" wide. Narrow Trims are 2 1/2" wide. Butt Wide Trim against the edge of a Narrow Corner Trim as shown in **Step 59**.

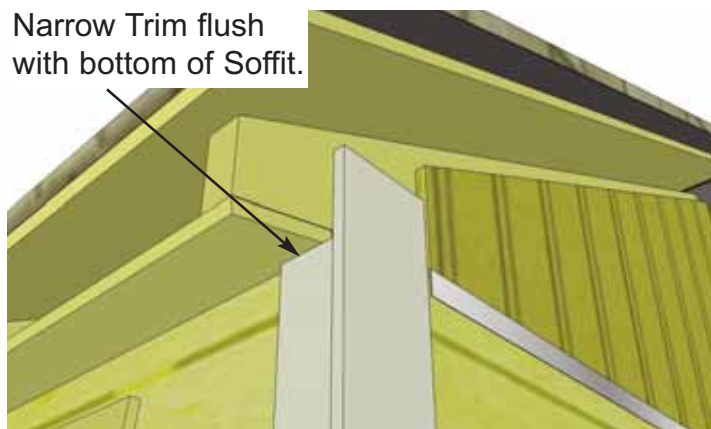
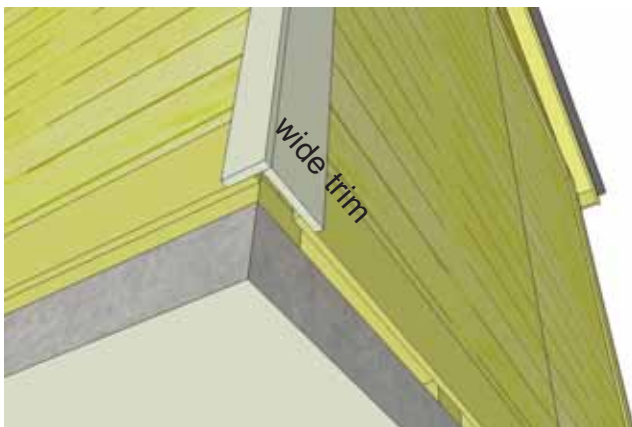

59. Position Trim flush with Bottom Skirting. At the top, Narrow Trim sits flush with bottom of Soffit while Wide Trim will extend over rafter. When correctly aligned, attach with 8 - 1 1/2" finishing nails per piece.

60. Attach **Rear Wall Narrow Trim** (2 - 1/2" x 2 1/2" x 79") where wall panels come together and leave a seam. Position trim equally on wall seam and flush at bottom of Bottom Skirting. Use 8 - 1 1/2" finishing nails per piece to secure. Attach both **Side Wall Narrow Trims** (77 1/2" long) where wall seams come together on sides. Once again, position trim equally on wall seam, flush at bottom of Bottom Skirting. Use 8 - 1 1/2" finishing nails per piece to secure.



Rear Wall Narrow Trim



Side Wall Narrow Trim

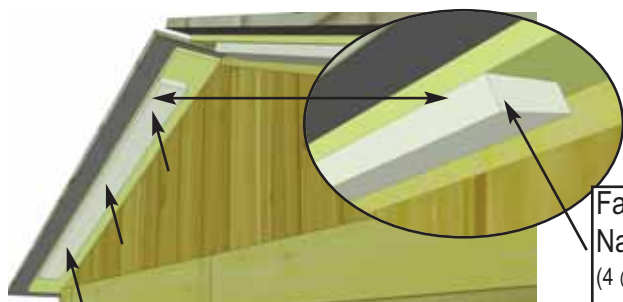

Facia/Roof
Nailing Strips
(4 @
3/4" x 2 1/2" x 48")

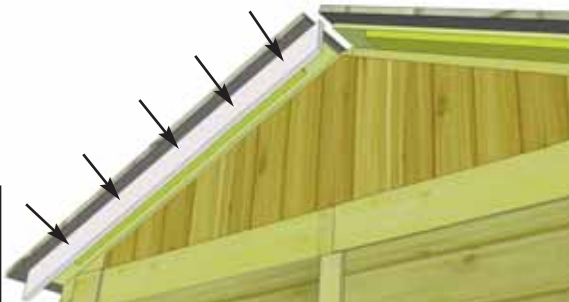

61. Attach **Facia/Roof Nailing Strips** (3/4" x 2 1/2" x 48") to the underside edge of the plywood roof. Nailing Strip will make it easier to attach Front and Rear Facia in **Step 62. Complete Front and Rear Strips (4 pieces total).**

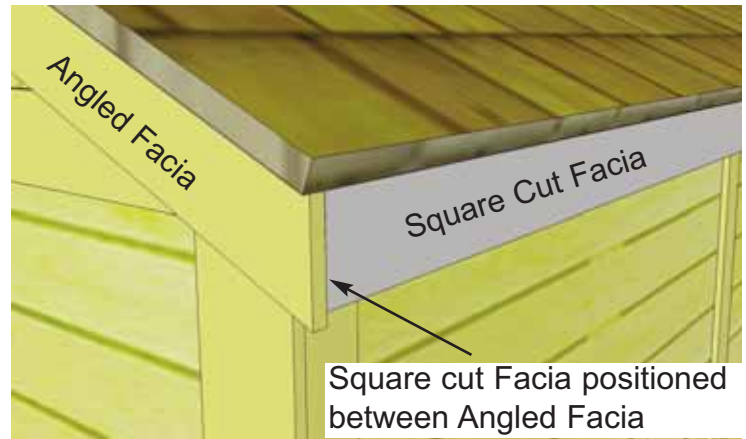
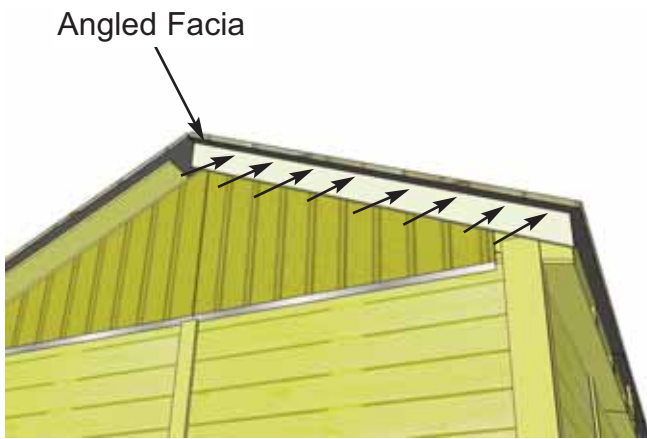

62. Position **Side Fascia** (angle cut on ends) and Front or Rear Fascia (square cut ends) in corner. Line Fascia up so square cut Fascia is positioned between angled cut fascia. Attach angled fascia to plywood end with 8 - 1 1/2" finishing nails per piece. Gap where fascia boards come together at peak will be covered in **Step 64**. Do a dry run using Fascia to help you correctly position before attaching.

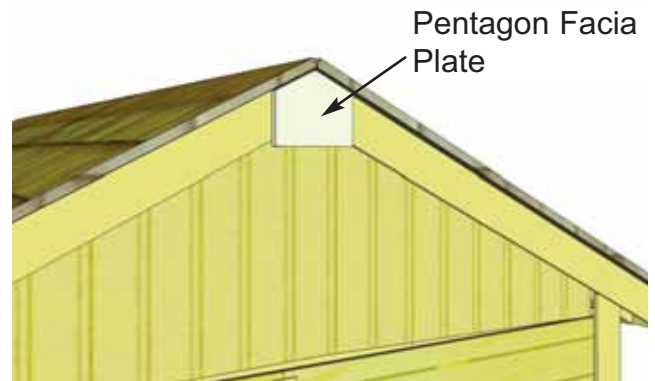
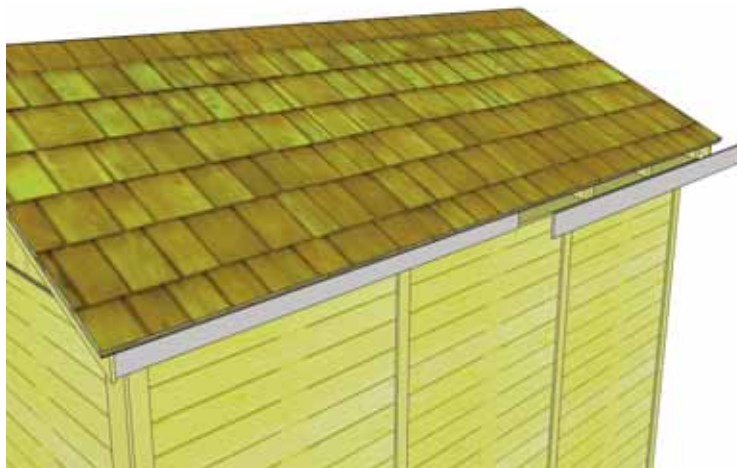

63. Attach **Front & Rear Fascia** to roof rafter ends. There are 2 Fascia pieces per side. Secure with 8 - 1 1/2" finishing nails per piece.

64. Attach **Pentagon Fascia Plate** where end Fascia meets at the peak. Use 4 - 1 1/2" finishing nails per piece to secure.



65. Attach **Horizontal Gable Trim** (4 - 1/2" x 4 1/2" x 44 1/2") to both sides of shed. Position equally over gable and wall seam. Use 4 - 1 1/2" finishing nails per piece to secure. (2 pieces per side). **Note:** Make sure gable trims cover flashing completely.

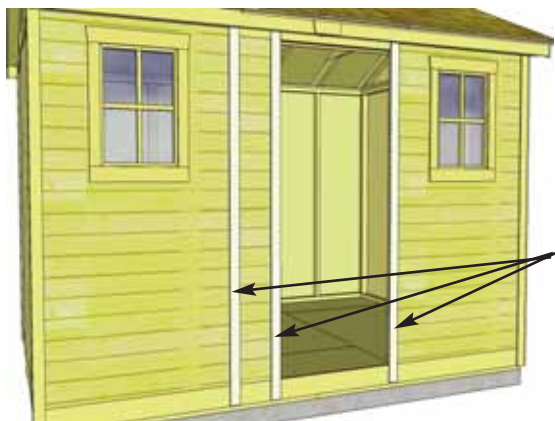

Narrow Trim

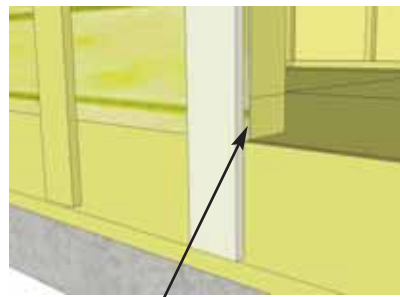

Flush with inside of door jamb and bottom skirting.

66. Position **Doorway Narrow Trims** (2 - 1/2" x 2 1/2" x 79) flush with inside of door jamb and flush with Bottom Skirting. Attach with 8 - 1 1/2" finishing nails. Attach final **Narrow Wall Trim** (79" long) where seam of narrow wall and window wall come together.



67. Attach **Facia/Trim Detail Plates** to cover seam where fascia and horizontal trim pieces come together. Secure each with 4 - 1 1/2" finishing nails.

Alternate Ridge Cap Seams
(Offsetting angle cut at peak)

Important: Butt (thick) end of Ridge Cap will be facing towards the outside of shed.

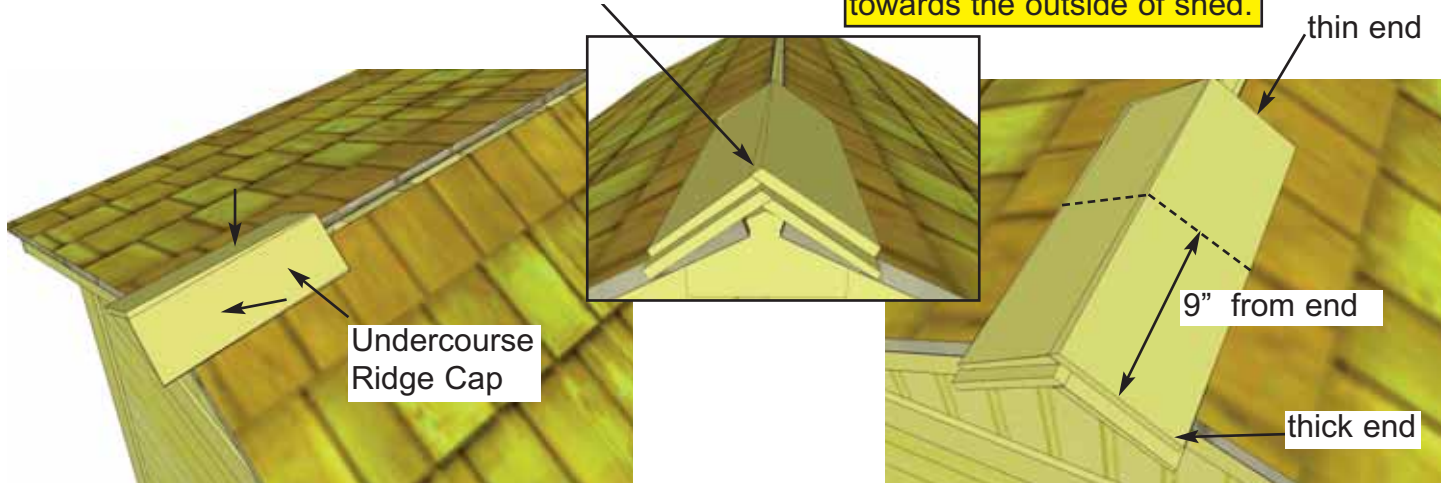

68. Place First Roof Ridge Cap (Lower Grade Undercourse Ridge Cap) on roof peak overhanging shingles by approximately 1". Attach with 2 - 1 1/2" Shingle Nails 9" from end. Place 2nd Ridge Cap 1" back from 1st cap. Attach with 2- 1 1/2" Shingle Nails 9" from end. Alternate each Ridge Cap seam as you proceed.

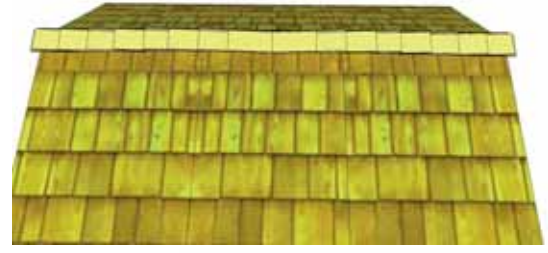
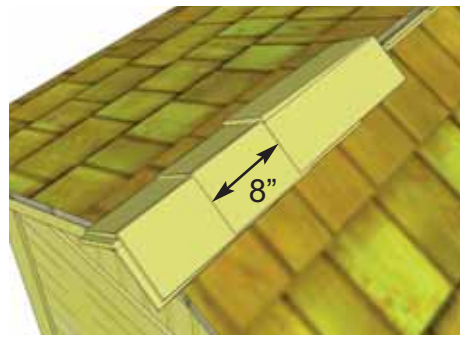
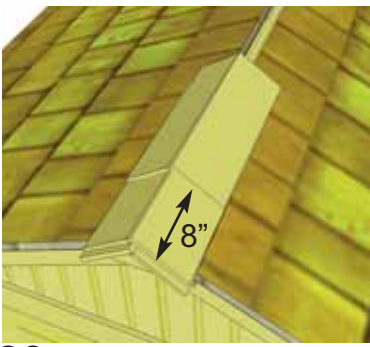

69. Place 3rd Ridge Cap 8" back from 2nd. (enough to cover shingle nails). Attach 3rd Ridge Cap down as per **Step 68**. Continue to position and attach Ridge Caps until half roof is complete. From opposite side, position and attach Ridge Caps as described above. Score/cut 1 Ridge Cap to 12" or to fit in the center of roof. Attach center cap with 4 - 1 1/2" Shingle Nails.

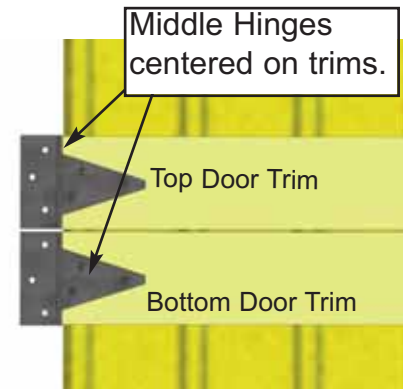
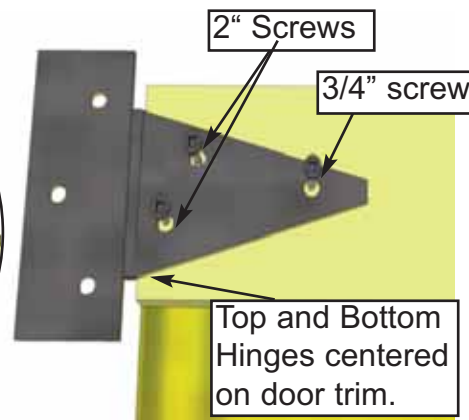
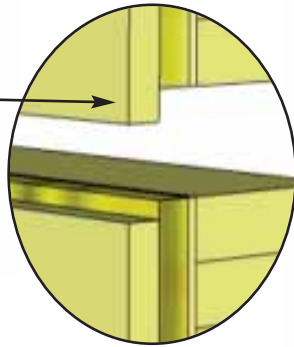
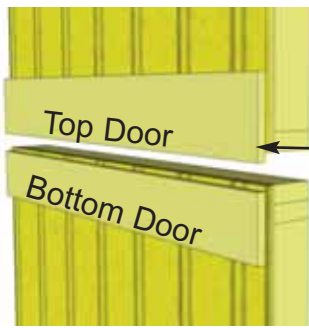
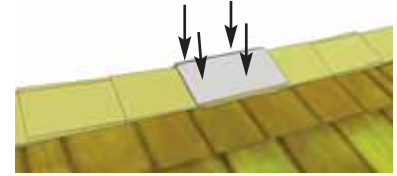

70. Attach Door Hinges to **Top** and **Bottom Dutch Door** sections. Top Door has trim overhanging door at bottom while bottom door has trim recessed slightly. Hinges should be centered on door trim with barrel nudged to end of trim. Use 2" & 3/4" black headed screws as shown above.

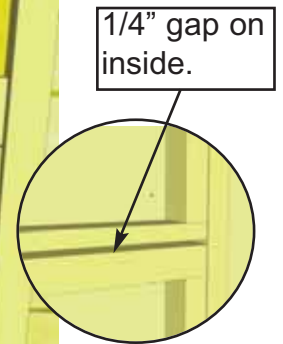
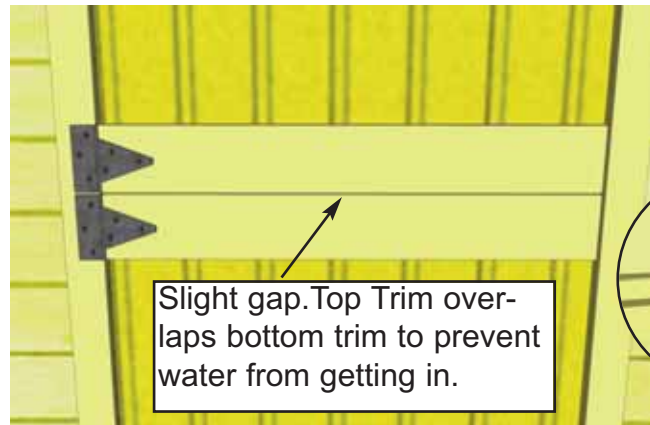
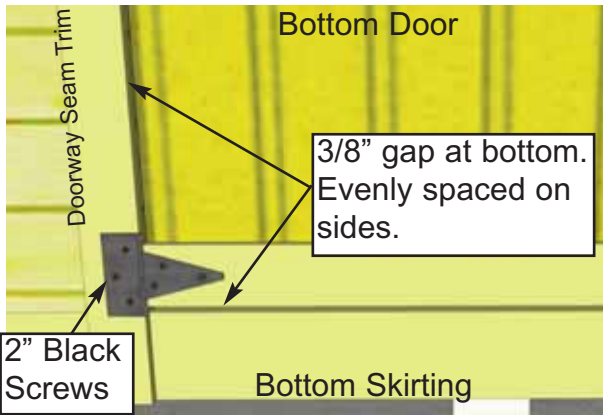

71. Place Bottom Dutch Door panel into position. Gap 3/8" on bottom, evenly space on sides, and attach hinge to doorway seam trim with 2" black headed screws. Use shim to help keep the door evenly spaced on bottom. One of the extra roof shingles (see parts list) can be used.

72. Place the Top Dutch Door Panel into place and gap top and bottom trims on the outside about 1/8" apart. On the inside, horizontal door frames should be about 1/4" apart. Use a shim once again to help you. Attach hinges to trim with 2" black headed screws provided.



73. To complete trimming of your Door, attach both the **Horizontal Door Trim** and **Horizontal Narrow Wall Trim** with 4 and 2 - 1 1/2" finishing nails.

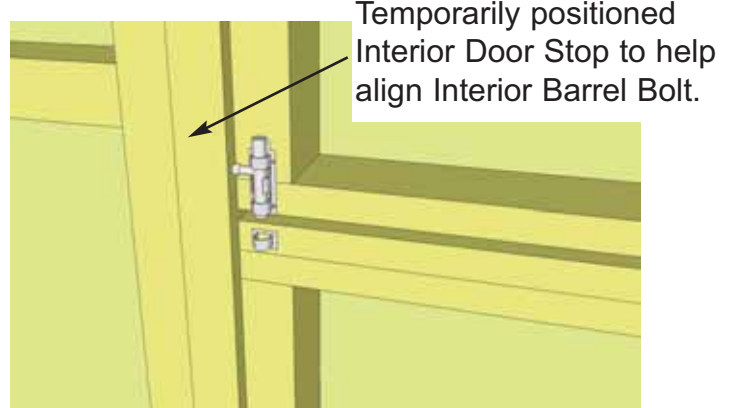

Temporarily positioned Interior Door Stop to help align Interior Barrel Bolt.

74. Attach **Door Handle**, **Exterior Barrel Bolt** and **Interior Barrel Bolt** to door. Handle is positioned on top door, Barrel Bolt on bottom door and Interior Barrel Bolt (silver) to top door stud. Attach Black Barrel Bolt as illustrated above with 3/4" Black Screws. Note how female part of Barrel Bolt is positioned higher than male. Do a dry run first to position Barrel Bolt correctly. **Important:** Drill shallow pilot holes with 1/8" drill bit prior to securing with screws to prevent wood splitting.

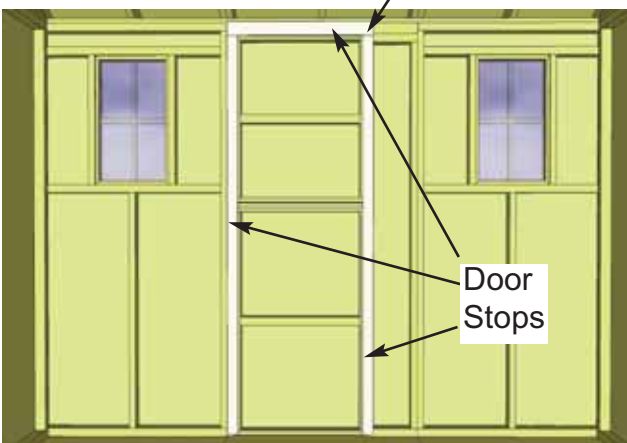
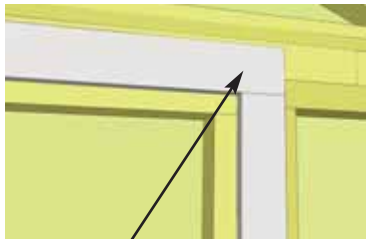

Door Stops

75. Attach Interior **Door Stops** to door framing. Start with Horizontal piece first. Use 4 - 2" screws to secure each Stop. Stops should overlap door by approx. 1/2".



76. Assemble **Flower Box Kit** with Assembly Instructions included. Position completed Flower Box below bottom of window trim and secure with 2 - 2" screws per box. Screw from inside of box into the center wall stud. Attach second screw 2" underneath first screw and once again into the wall stud. Install 2nd Flower Box Kit.



Note: Our Sheds are shipped as an unfinished product. If exposed to the elements, the western red cedar lumber will weather to a silvery-gray color. If you prefer to keep the cedar lumber looking closer to the original color, we suggest that you treat the wood with a good oil base wood stain. You may also wish to paint your new shed rather than stain it. In both cases we recommend that you consult with a paint and stain dealer in your area for their recommendations.



We hope your experience constructing our building has been both positive and rewarding.

We value your feedback and would like to hear back from you on how well we are doing in the following areas:

1. Customer Service
2. On Time Shipping
3. Motor Freight Delivery
4. Quality of Materials
5. Assembly Manual
6. Overall Satisfaction.

Please call, write or email us at:

Outdoor Living Today

Canadian Address
9393 287th Street
Maple Ridge, British Columbia
Canada V2W 1L1

United States Address
P.O. Box 96
Sumas, Washington
USA 98295



The materials contained in this Assembly Manual may be downloaded or copied provided that ALL copies retain the copyright and any other proprietary notices contained on the materials. No material may be modified, edited or taken out of context such that its use creates a false or misleading statement or impression as to the positions, statements or actions.