

# Home Decorators

—Collection—

BF-21425 Oxford Bookcase with Clear Glass Doors 36"W-6 Shelf

## ASSEMBLY INSTRUCTIONS

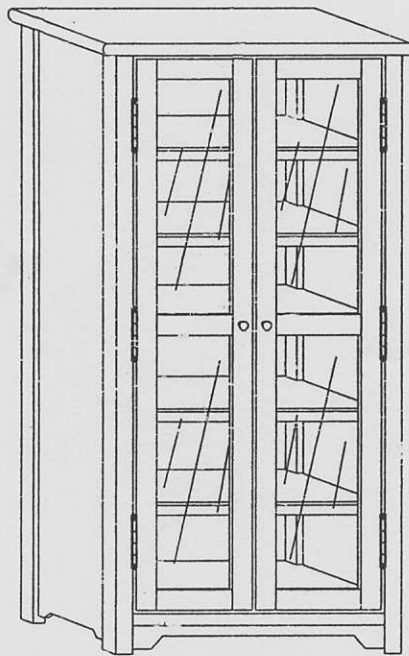

Made In China



Thank you purchasing this quality product. Be sure to check all packing material carefully for small parts, which may have come loose inside the carton during shipment. Count all parts and material hardware, Compare with parts list to be sure all part are present. If any parts are missing or damaged, phone, fax, or mail to our Customer Service Department. For efficient and speedy service please indicate the model number and code letter of part(s) need

**IMPORTANT NOTE:** Follow instructions listed below in proper sequence as numbered to assure fast, easy and correct assembly.

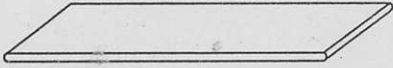
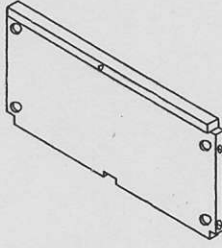
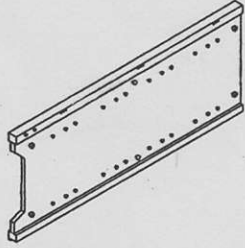
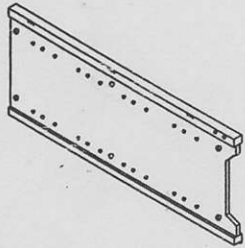
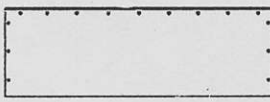
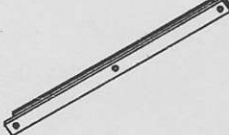
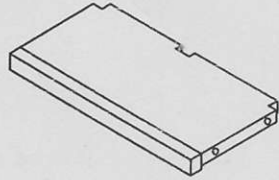
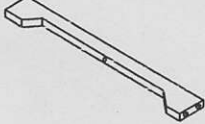
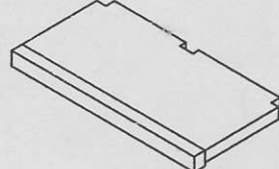
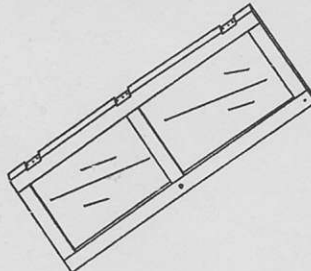
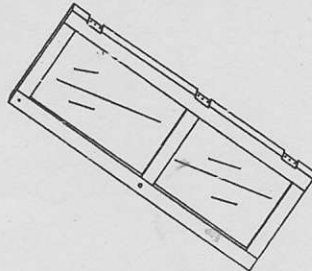
## PARTS LIST

<p>A</p>  <p>TOP PANEL-1PC</p>	<p>B</p>  <p>BOTTOM PANEL-1PC</p>	<p>C</p>  <p>LEFT SIDE PANEL-1PC</p>
<p>D</p>  <p>RIGHT SIDE PANEL-1PC</p>	<p>E</p>  <p>BACK PANEL-2PCS</p>	<p>F</p>  <p>REAR PANEL GUIDE-1PC</p>
<p>G</p>  <p>ACROSS PANEL-1PC</p>	<p>H</p>  <p>LOW PANEL-1PC</p>	<p>I</p>  <p>SHELF-4PCS</p>
<p>J</p>  <p>RIGHT DOORS-1PC</p>	<p>K</p>  <p>LEFT DOORS-1PC</p>	<p>L</p>  <p>CAM-BOLTS-12PCS</p>

M



CAM-LOCKS-12PCS

N



CAM-TOOL-1PC

O

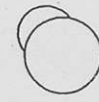

KNOB-2PCS

P



SCREWS-34PCS

Q



SCREWS-3PCS

R



DOWELS-4PCS

S



SCREWS-2PCS

T



SCREWS-1PC

U



HINGES-6PCS

V

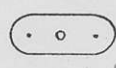

FEMALE MAGNETS-4PCS

W



LARGE MAGNETS-2PCS

X



SCREWS-40PCS

Y



SHELF SUPPORTS-16PCS

NOTE: • UPON OPENING THOROUGHLY CLEAN ALL WOODS SURFACES TO REMOVE DUST AND DIRT THAT MAY HAVE SETTLED ONTO FINISH DURING SHIPMENT. IN ORDER TO PREVENT DAMAGE DURING ASSEMBLY, PLEASE ASSEMBLE THIS ITEM WITH AT LEAST TWO PEOPLE.

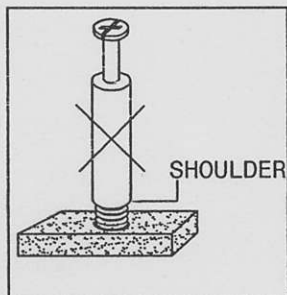
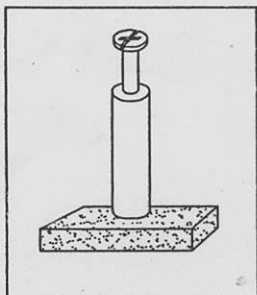

NOTE: TURN THE CAM-BOLT SCREWS UNTIL THEY ARE TIGHT, THE SHOULDER SHOULD BE AGAINST THE SURFACE OF THE PART.

## HOW TO USE THE CAM-TOOL

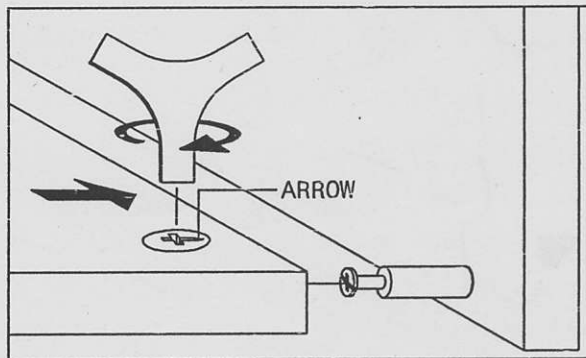
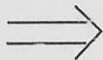
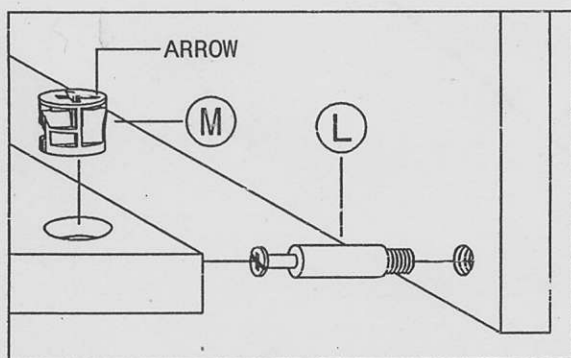

NOTE: • THE ARROWS ON THE HIDDEN CAM-LOCKS SHOULD POINT TO THE CAM-BOLTS

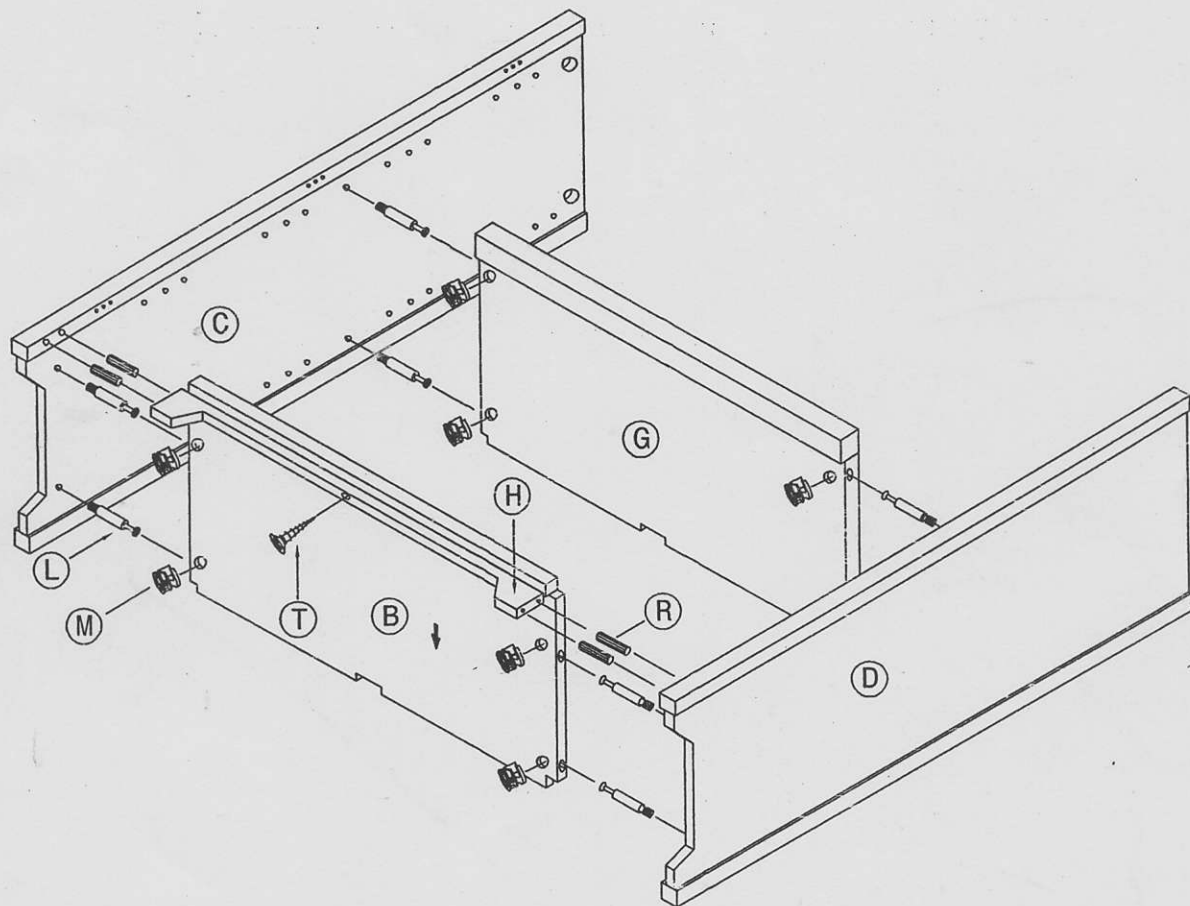

1) ASSEMBLE THE SIDE PANEL (C/D).

- ATTACH THE LOW PANEL (H) TO BOTTOM PANEL (B) USING SCREWS (T).
- INSERT THE 4 DOWELS (R) INTO HOLE IN LOW PANEL (H).
- ROTATE THE CAM-BOLTS (L) INTO HOLES IN SIDE PANEL (C/D).
- PLACE CAM-BOLTS (L) INTO HOLES IN ACROSS PANEL (B/G) AND ATTACH USING CAM-LOCKS (M).



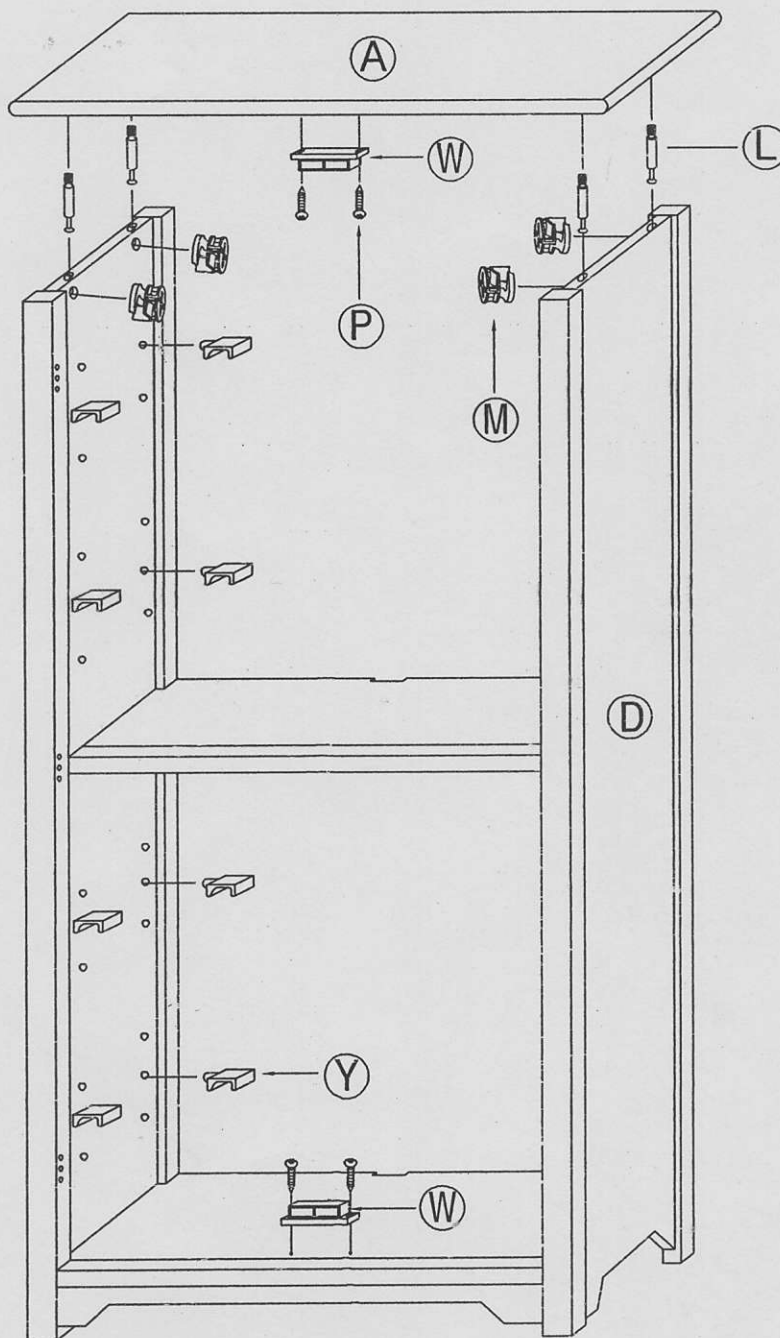

## 2) .ASSEMBLE THE TOP PANEL(A) .

- ATTACH 2 MAGNETS(W) USING SCREWS(P) INTO THE PREDRILLED HOLES OF PANEL(A/B) .
- INSERT THE 16 SHELF SUPPORTS(Y) INTO HOLES IN SIDE PANEL(C/D) .
- ROTATE THE CAM-BOLTS(L) INTO HOLES IN TOP PANEL(A) .
- PLACE CAM-BOLTS(L) INTO HOLES IN SIDE PANEL(C/D) AND ATTACH USING CAM-LOCKSS(M) .

NOTE: Attach the right door(J) by the same method as the left door(K) with screws, female magnet and hinges.

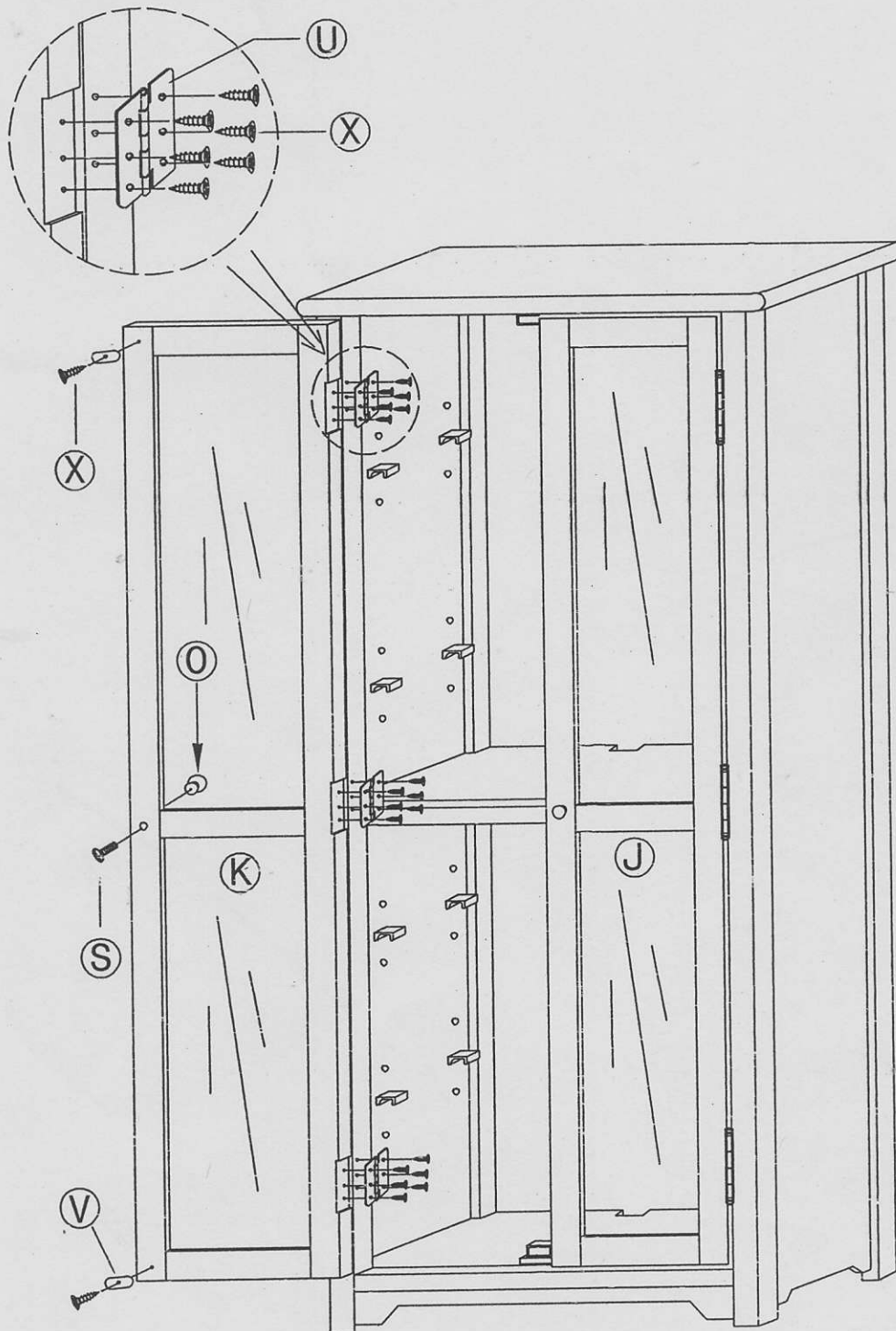

3) .ASSEMBLE THE DOORS(J/K) .

- ATTACH 3 HINGE(U) TO LEFT DOOR(K) AND LEFT SIDE PANEL(C) USING 18 SCREWS(X) .
- ATTACH THE 2 FEAMEL MAGNETS(V) TO LEFT DOOR(K) USING 2 SCREWS(X) .
- ATTACH THE KNOB(O) TO LEFT DOOR(K) USING SCREWS(S) .

Note: Before you assemble the back panel, please make sure the doors have an even gap around them. If uneven, shift the unit LEFT OR RIGHT UNTIL the doors are evenly spaced, then attach back panel.

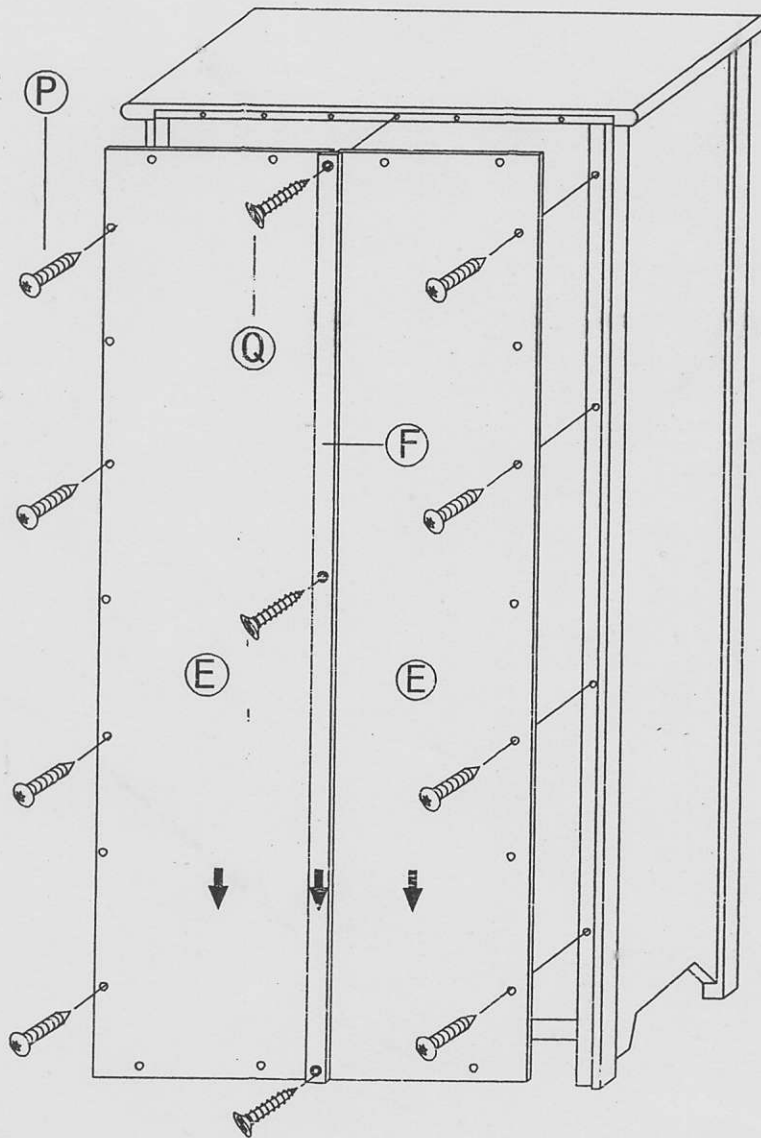

#### 4) ASSEMBLE THE BACK PANEL (E).

- INSERT THE BACK PANEL (E) INTO SLOT IN REAR PANEL GUIDE (F).
- ATTACH THE BACK PANEL (E) AND REAR PANEL GUIDE (F) USING SCREWS (P/Q).



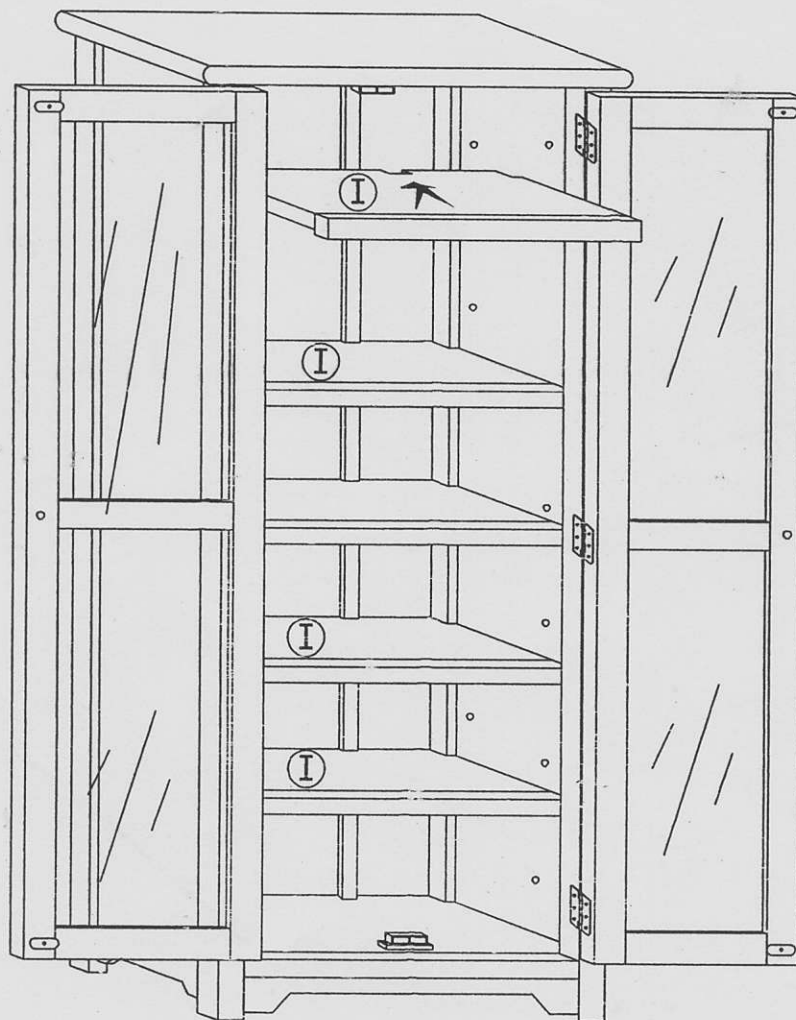

5) ASSEMBLE THE SHELF (I).

- PUT THE 4 SHELF (I) ONTO THE SHELF SUPPORTS (Y).

W1



HOOK - 2PCS

X1



SCREWS - 2PCS

Y1



HANGER - 2PCS

Z1



SCREWS - 2PCS

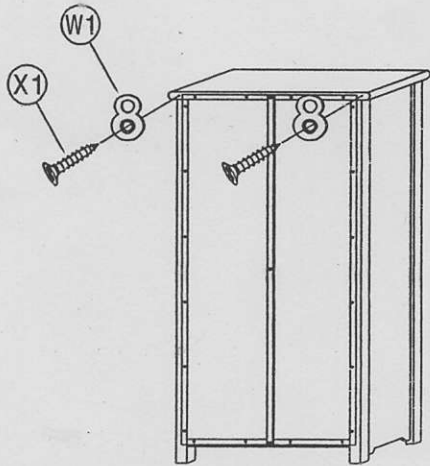

- I** • ATTACH 2 HOOK(W1) USING 2 SCREWS(X1) IN THE PREDRILLED HOLES OF REAR TOP PANEL.

- II** • DRILLING TWO HOLES ON THE WALL IT AS BETWEEN TOP PANEL HOLES DISTANCE.  
• PUT 2 HANGER(Y1) HIT INTO HOLES IN WALL AND ROTATE 2 SCREWS(Z1) INTO HANGER(Y1).

