

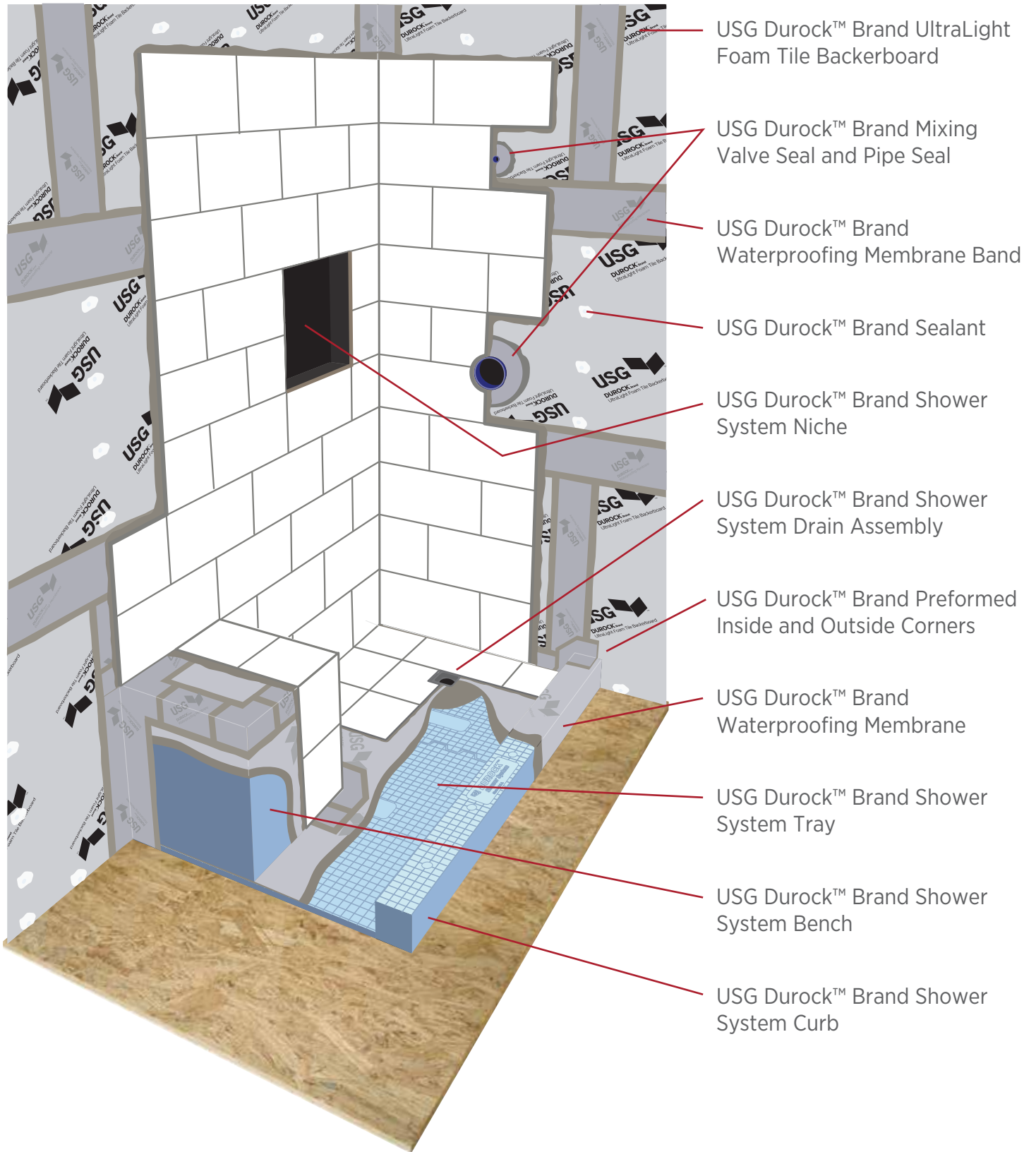

# USG DUROCK™ BRAND SHOWER SYSTEM

## Shower Installation Guide

# SHOWER INSTALLATION



## DRAIN ASSEMBLY AND GRATE ASSEMBLY

### USG Durock™ Brand Shower System:



## WHAT YOU'LL NEED

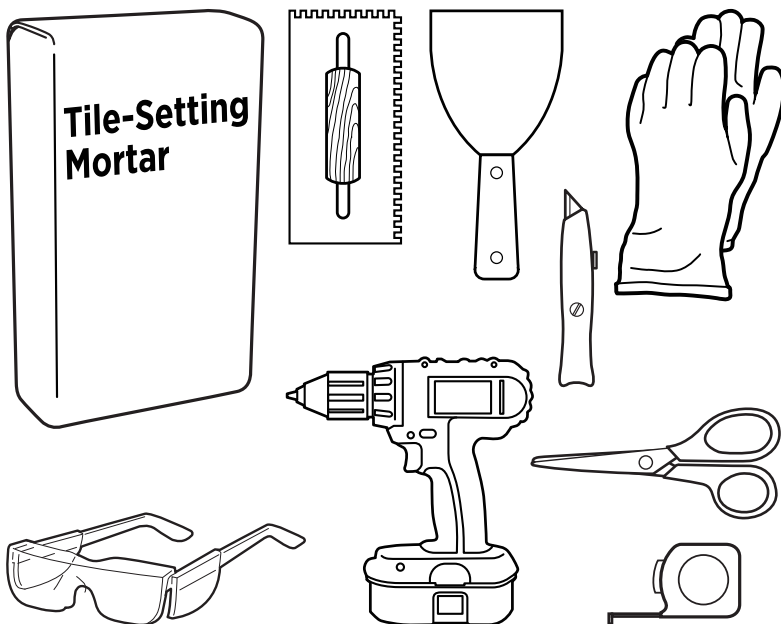

- Tile-setting mortar meeting ANSI A118.1, A118.4, A118.11 or A118.15
- 3/16 in. x 3/16 in. (5 mm x 5 mm) v-notched trowel or 1/8 in. x 1/8 in. (3 mm x 3 mm) square or u-notched trowel
- 1/4 in. x 3/8 in. (6 mm x 10 mm) square or u-notched trowel
- Margin Trowel
- Safety Glasses
- Gloves
- Drill
- Finishing Trowel
- Utility Knife
- Scissors
- Tape Measure

### SAFETY FIRST!

Follow good safety/industrial hygiene practices during installation. Wear appropriate personal protective equipment. Read SDS and literature before specification and installation.

## SHOWER WALLS (TRADITIONAL BACKERBOARD)

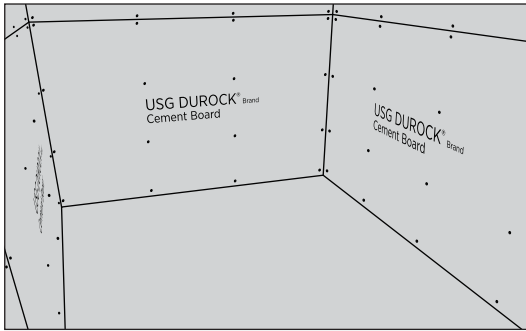

### STEP 1

Use only code-approved wall substrate suitable for wet areas, such as USG Durock® Brand Cement Board or USG Fiberrock® Tile Backerboard with a waterproofing membrane. Refer to [usg.com](http://usg.com) for backerboard installation instructions.

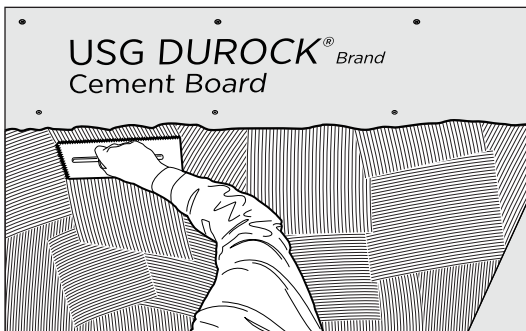

### STEP 2

Apply tile-setting mortar to wall substrate using a 3/16 in. x 3/16 in. (5 mm x 5 mm) v-notched trowel or 1/8 in. x 1/8 in. (3 mm x 3 mm) square or u-notched trowel.

**Tip:** The mortar should be loose but still hold ridges from your trowel.

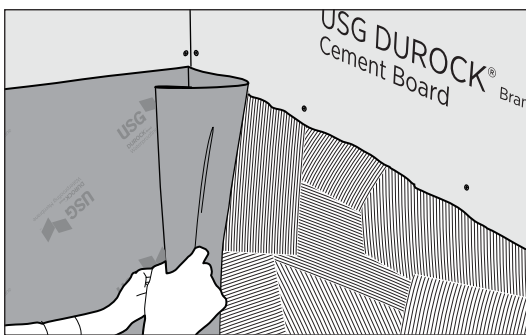

### STEP 3

Embed USG Durock™ Brand Waterproofing Membrane into the mortar using a finishing trowel, drywall taping knife, or similar tool to remove air pockets and to ensure proper adhesion.

**Tip:** Start from the center of the wall and work toward the edges.

**Note:** Use USG Durock™ Brand Liquid Waterproofing Membrane as an alternate waterproofing option. Refer to CB817 on [usg.com](http://usg.com) for installation instructions.

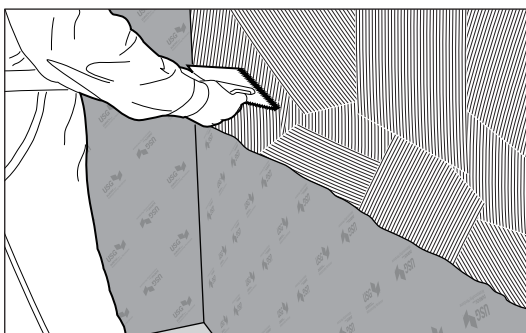

### STEP 4

Overlap all adjoining sections of the USG Durock™ Waterproofing Membrane a minimum of 2 in. (51 mm).

**Note:** Shingle-lapping of membrane is not required, provided that a minimum 2 in. (51 mm) overlap is maintained at all joints. Alternatively, adjoining sections of USG Durock™ Waterproofing Membrane can be abutted and then seamed with 5 in. (127 mm) wide USG Durock™ Brand Waterproofing Membrane Band.

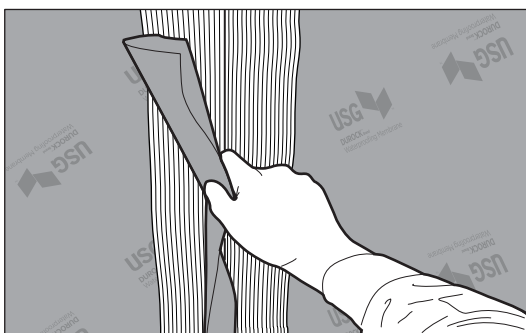

### STEP 5

Install USG Durock™ Brand Waterproofing Membrane Band at all vertical inside wall corners using a tile-setting mortar and a 3/16 in. x 3/16 in. (5 mm x 5 mm) v-notched trowel or 1/8 in. x 1/8 in. (3 mm x 3 mm) square or u-notched trowel.

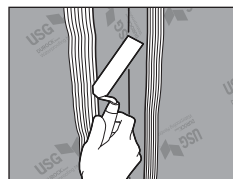

**Tip:** To center waterproofing membrane band at inside wall corners, crease waterproofing membrane band by folding in half lengthwise. Embed waterproofing membrane band in tile-setting mortar using a drywall taping knife or margin trowel.

## SHOWER WALLS (ALREADY WATERPROOF BACKERBOARD)

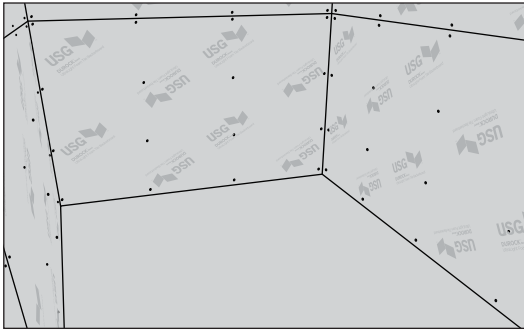

### STEP 1

If using an already waterproof backerboard, such as USG Durock™ Brand UltraLight Foam Tile Backerboard, or a coated glass-mat tile backerboard approved for wet areas, refer to [usg.com](http://usg.com) for backerboard installation instructions.

**Note:** If using a coated glass-mat tile backerboard approved for wet areas, treat joints and fastener penetrations with ANSI A118.10 waterproofing membrane.

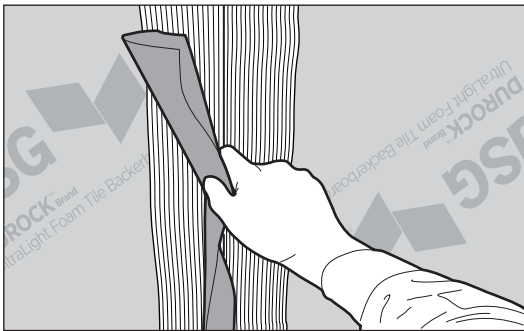

### STEP 2

Install USG Durock™ Brand Waterproofing Membrane Band at all vertical inside wall corners using a tile-setting mortar and a 3/16 in. x 3/16 in. (5 mm x 5 mm) v-notched trowel or 1/8 in. x 1/8 in. (3 mm x 3 mm) square or u-notched trowel.

**Note:** Treat fastener penetrations with USG Durock™ Brand Sealant. Apply only enough sealant to sufficiently cover the fastener head and then strike flush using a margin trowel or similar.

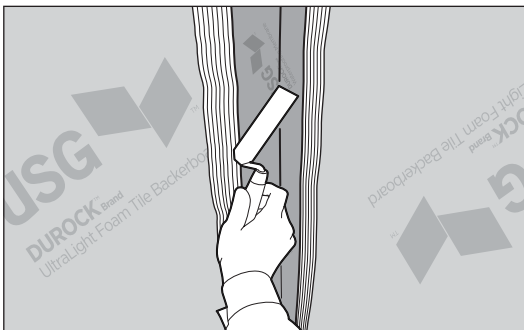

**Tip:** To center waterproofing membrane band at inside wall corners, crease waterproofing membrane band by folding in half lengthwise. Embed waterproofing membrane band in tile-setting mortar using a drywall tapping knife or margin trowel.



## MIXING VALVE SEAL & PIPE SEAL

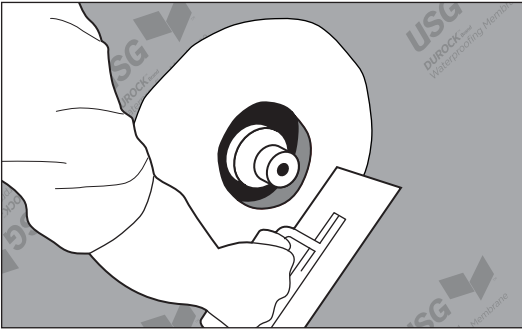

### STEP 1

Apply tile-setting mortar to the substrate using a 3/16 in. x 3/16 in. (5 mm x 5 mm) v-notched trowel or 1/8 in. x 1/8 in. (3 mm x 3 mm) square or u-notched trowel.

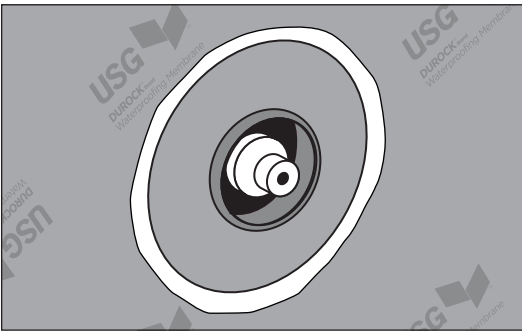

### STEP 2

Place seal into mixing valve opening and embed into the mortar using a finishing trowel, drywall taping knife, or similar tool to remove air pockets and to ensure proper adhesion. Place seal over pipe and embed into the mortar using a finishing trowel, drywall taping knife, or similar tool to remove air pockets and to ensure proper adhesion.

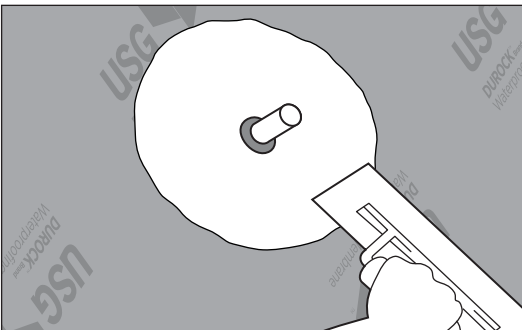

### STEP 3

Apply tile-setting mortar to the substrate using a 3/16 in. x 3/16 in. (5 mm x 5 mm) v-notched trowel or 1/8 in. x 1/8 in. (3 mm x 3 mm) square or u-notched trowel.

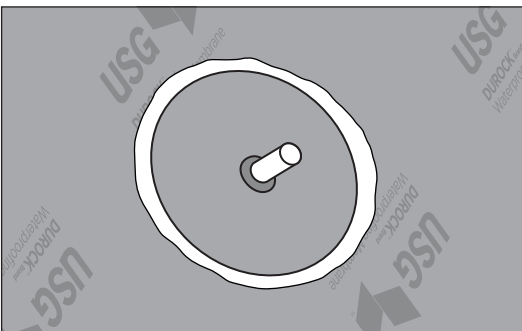

### STEP 4

Place seal over pipe and embed into the mortar using a finishing trowel, drywall taping knife, or similar tool to remove air pockets and to ensure proper adhesion.

## SHOWER TRAY, DRAIN ASSEMBLY & CURB

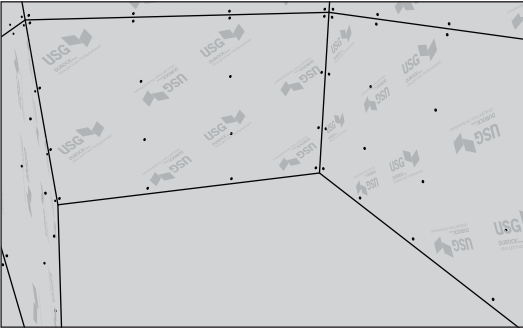

### STEP 1

Place shower tray disk on subfloor at desired drain location. Using the removable subfloor cutout template on the shower tray disk, trace the hole location on the subfloor before cutting.

**Note:** Alignment of drain grate to tile layout must be established before cutting the hole in the level subfloor.

**Tip:** Dry-lay the pre-sloped shower tray, then align the shower tray disk with the clock marks on the tray to the desired position before marking and cutting the hole in the subfloor.

Cut hole in desired location and ensure floor is level before proceeding. If necessary, apply USG Durock™ Brand Self-Leveling Underlayment.

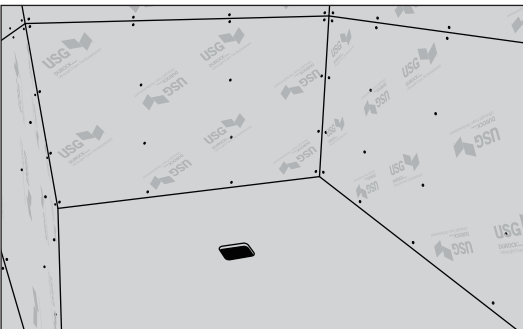
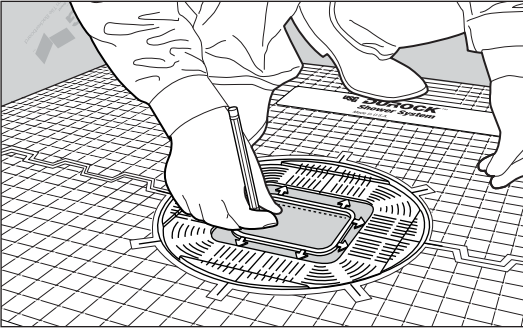

### STEP 2

Apply tile-setting set mortar to the subfloor using a 1/4 in. x 3/8 in. (6 mm x 10 mm) square or u-notched trowel.



### STEP 3

Firmly embed USG Durock™ Brand Shower System Pre-Sloped Shower Tray into the mortar. Check underside of tray to ensure full mortar coverage.

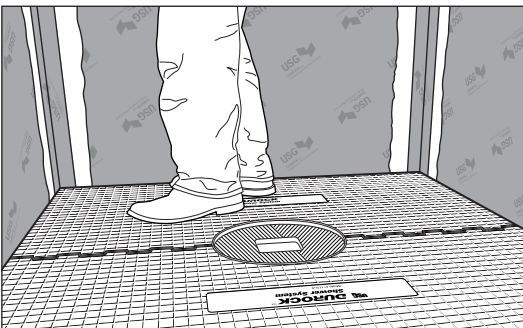

## SHOWER TRAY, DRAIN ASSEMBLY & CURB

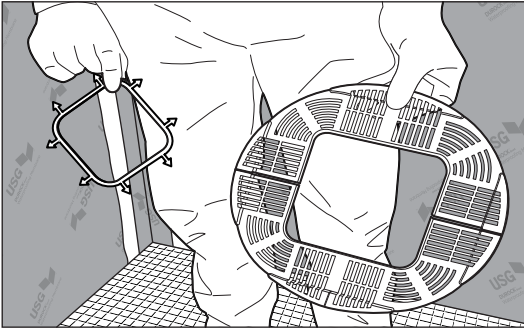

### STEP 4

Remove integrated cutout template (used for drain hole cutout in subfloor) from shower tray disk prior to installation.

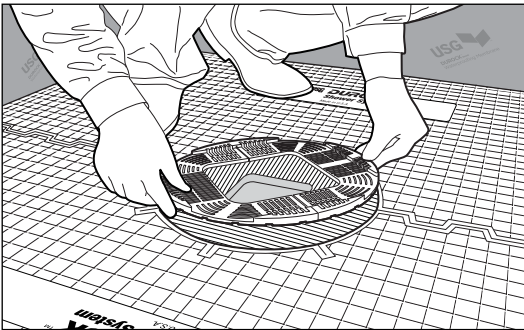

### STEP 5

Install shower tray disk by fully embedding in the tile-setting mortar and position to match drain hole orientation using the clock marks on the shower tray.

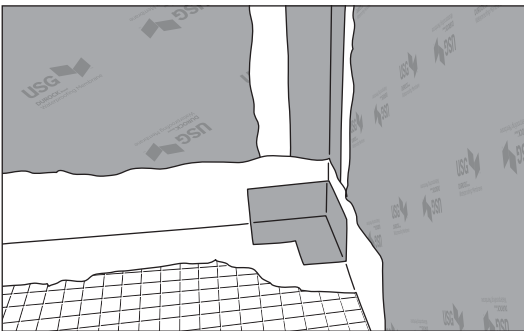

### STEP 6

Apply tile-setting mortar to pre-sloped shower tray and wall junction using a 3/16 in. x 3/16 in. (5 mm x 5 mm) v-notched trowel or 1/8 in. x 1/8 in. (3 mm x 3 mm) square or u-notched trowel. Embed USG Durock™ Brand Shower System Preformed Inside Corners into the mortar, using a drywall knife or margin trowel to remove air pockets and ensure proper adhesion to shower tray and wall junction.

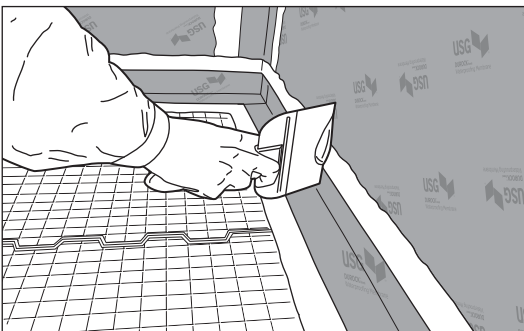

### STEP 7

Install USG Durock™ Waterproofing Membrane Band at all floor/wall junctions using tile-setting mortar and a 3/16 in. x 3/16 in. (5 mm x 5 mm) v-notched trowel or 1/8 in. x 1/8 in. (3 mm x 3 mm) square or u-notched trowel.

**Tip:** To center waterproofing membrane band at floor/wall junctions, crease waterproofing membrane band by folding in half lengthwise. Embed waterproofing membrane band in tile-setting mortar using a drywall taping knife or margin trowel.

**Note:** Shingle-lapping of the USG Durock™ Waterproofing Membrane Band is not required.

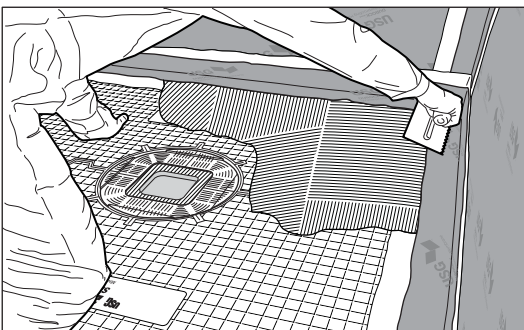

### STEP 8

Apply tile-setting mortar to the surface of the pre-sloped shower tray and shower tray disk—make sure to fill the shower tray disk—and apply the mortar to the bottom of the drain bonding flange. Apply the mortar with a 3/16 in. x 3/16 in. (5 mm x 5 mm) v-notched trowel or 1/8 in. x 1/8 in. (3 mm x 3 mm) square or u-notched trowel.

**Tip:** Before applying mortar to shower tray and shower tray disk, establish the location of the hole in the waterproofing membrane that corresponds to the recessed area at the top of the drain body by first dry-fitting the drain body and membrane. Cut the opening in the waterproofing membrane using the provided membrane cut-out template.



## SHOWER TRAY, DRAIN ASSEMBLY & CURB

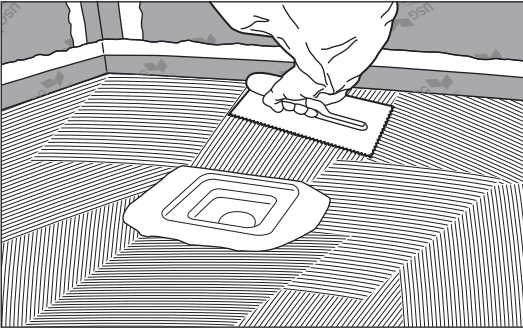

### STEP 9

Next, install the USG Durock™ Brand Drain Assembly into the shower tray disk, pressing firmly to ensure proper alignment and full support of the bonding flange. Once in place apply tile-setting mortar to the top of the bonding flange. Do not fill the recessed areas of the bonding flange with mortar until the grate assembly is ready to be installed.

**Note:** If there is no access to the waste line from below, the USG Durock™ Drain Assembly must be connected to the waste line at the same time it is pressed into the mortar.

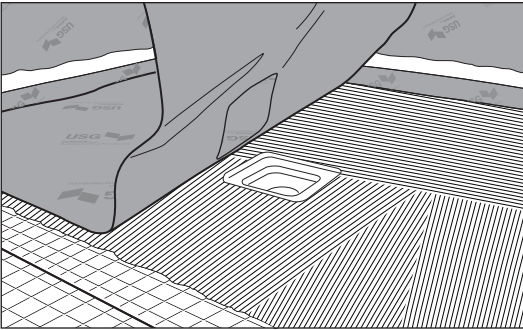

### STEP 10

Embed USG Durock™ Waterproofing Membrane into the mortar using a finishing trowel, drywall taping knife, or similar tool to remove air pockets and ensure proper adhesion to the pre-sloped shower tray and drain assembly bonding flange.

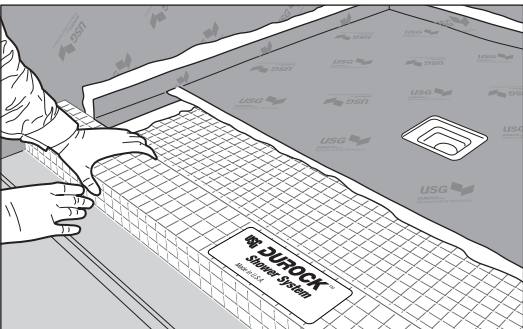

### STEP 11

Apply the tile-setting mortar to the subfloor and edge of the pre-sloped shower tray, curb(s), and adjacent walls—using a 1/4 in. x 3/8 in. (6 mm x 10 mm) square or u-notched trowel—and firmly press shower curb(s) into the mortar.

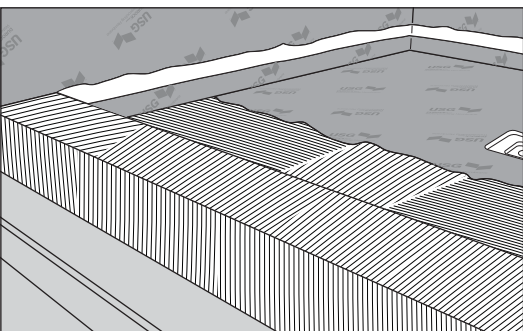

### STEP 12

Apply tile-setting mortar to the pre-sloped shower tray and curb(s) using a 3/16 in. x 3/16 in. (5 mm x 5 mm) v-notched trowel or 1/8 in. x 1/8 in. (3 mm x 3 mm) square or u-notched trowel.

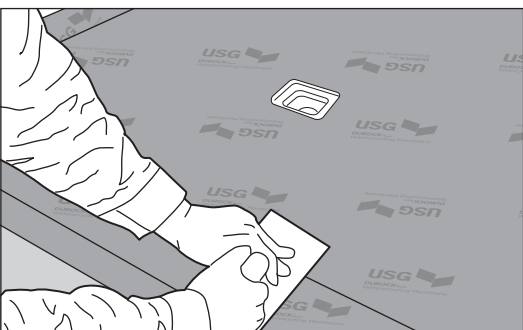

### STEP 13

Apply USG Durock™ Waterproofing Membrane to remaining pre-sloped tray section, overlapping seams a minimum of 2 in. (51 mm) and wrap over and around curb(s). Use a finishing trowel, drywall taping knife, or similar tool to remove air pockets and ensure proper adhesion.

## SHOWER TRAY, DRAIN ASSEMBLY & CURB

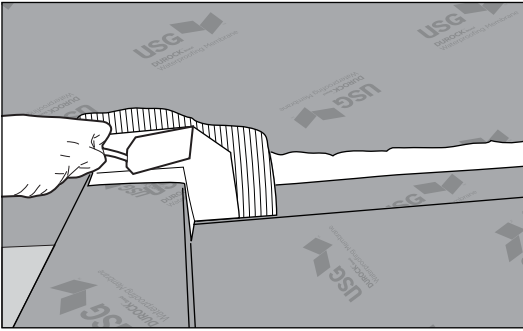

### Step 14

Install USG Durock™ Shower System Preformed Inside and Outside Corners to seal curb/wall/tray junctions using tile-setting mortar and a 3/16 in. x 3/16 in. (5 mm x 5 mm) v-notched trowel or 1/8 in. x 1/8 in. (3 mm x 3 mm) square or u-notched trowel. Embed preformed corners in the mortar using a drywall taping knife or margin trowel to ensure proper adhesion to shower curb(s), shower tray and walls.

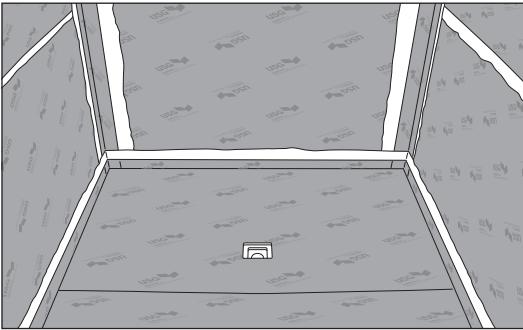

### Step 15

The USG Durock™ Shower System waterproofing application is now complete. Before water testing and setting tile, allow a minimum of 24 hours to ensure both proper curing of mortar and waterproof performance at all seams and connections.

### Step 16

Insert a water test plug and fill the shower with approximately 3 in. (76 mm) of water. After 24 hours check for leakage and remove the plug. This confirms the waterproofing is sound.

You are now ready to apply mortar to the shower walls and floor and set tile.

## GRATE ASSEMBLY

### STEP 1

The USG Durock™ Shower System Grate Assembly is installed at the same time as the floor tile.

**Tip:** Remove the construction plug from the grate tray by pushing up from the inside, then apply a light coating of petroleum jelly to the plug's edges to keep grout from bonding to the plug's perimeter (this is especially important when using urethane or epoxy grout which bonds more aggressively).

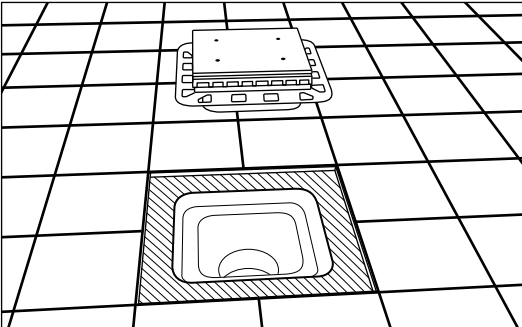

### STEP 2

Install the construction plug into the grate tray, and snap the assembly into the grate tray riser. Apply mortar to both the underside of the grate tray and to the recessed area of the drain assembly's bonding flange. Place the assembly into the horizontal adjustment ring, then place the grate assembly into the recessed area of the drain body.

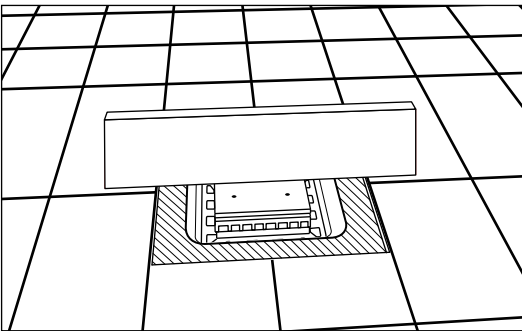

Align the grate assembly with the layout of the floor tile and adjust vertically to ensure the construction plug is even with, or slightly below, the surface of the surrounding tile.

**Tip:** During the grouting process expose the top surface of the construction plug up to its outer edges while keeping the grout joints immediately surrounding the plug as full as possible.

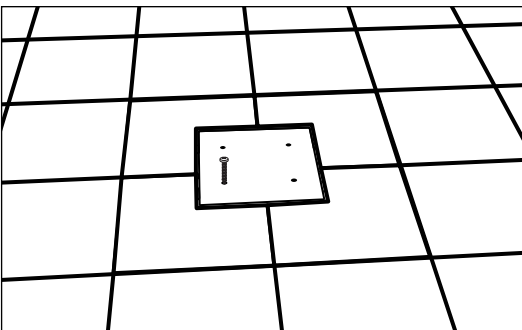

### Step 3

After grouting the shower floor, wait at least 24 hours before removing the construction plug. To remove the construction plug after grouting, press down firmly a few times on the center of the plug to create a separation line between the perimeter and surrounding grout joints. Insert a thin screw (drywall screw or similar) into one of the four start holes in the construction plug and thread the screw far enough in so that the screw grips the plug firmly, then use the screw to pull the plug out. Install the grate.

**Note:** The construction plug ensures that the grate tray remains absolutely square and in perfect form for subsequent installation of the grate. Removing the construction plug prematurely can cause the grout to crack, creating an improper fit to the grate.

For tile application, refer to manufacturer of setting material for specific information related.

### **PRODUCT INFORMATION**

See usg.com for the most up-to-date product information.  
Product safety information: 800 507.8899 or usg.com.  
KEEP OUT OF REACH OF CHILDREN.

### **SAFETY FIRST!**

Follow good safety/industrial hygiene practices during installation. Wear appropriate personal protective equipment. Read SDS and literature before specification and installation.

### **WARRANTY**

See USG literature CB653

### **CUSTOMER SERVICE**

800 621.9523

### **TECHNICAL SERVICE**

800 USG.4YOU  
800 874.4968

### **WEBSITE**

durockshowersystem.com  
usg.com



facebook.com/USGBuild



twitter.com/USGBuild



youtube.com/USGCorp



pinterest.com/USGCorporation