



OPERATOR'S MANUAL

MANUEL D'UTILISATION

MANUAL DEL OPERADOR

40 VOLT
BLOWER
SOUFFLANTE 40 V
SOPLADORA DE 40 V

RY40402

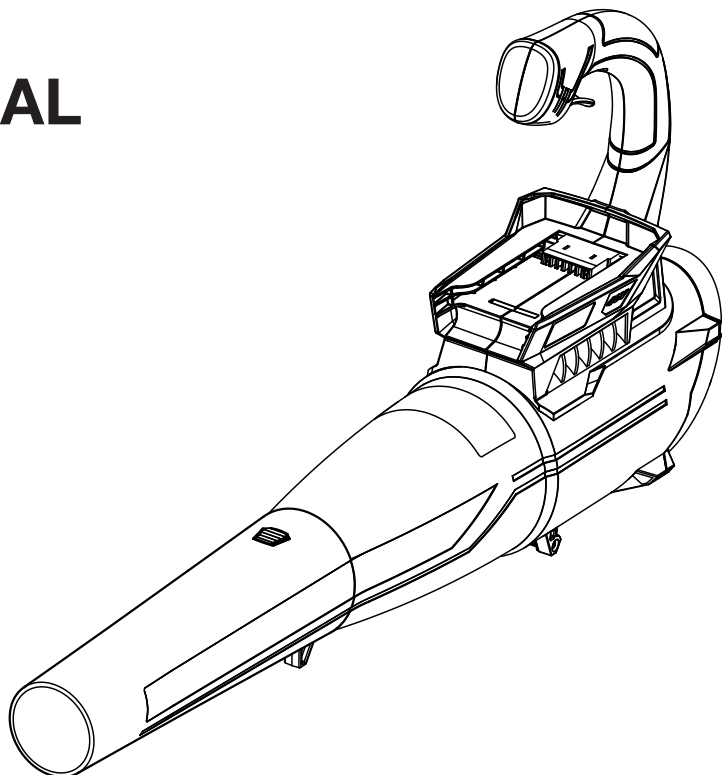

Your blower has been engineered and manufactured to our high standard for dependability, ease of operation, and operator safety. When properly cared for, it will give you years of rugged, trouble-free performance.

⚠ WARNING: To reduce the risk of injury, the user must read and understand the operator's manual before using this product.

Thank you for your purchase.

SAVE THIS MANUAL FOR FUTURE REFERENCE

Ce soufflante a été conçu et fabriqué conformément à nos strictes normes de fiabilité, simplicité d'emploi et sécurité d'utilisation. Correctement entretenu, cet outil vous donnera des années de fonctionnement robuste et sans problème.

⚠ AVERTISSEMENT :
Pour réduire les risques de blessures, l'utilisateur doit lire et veiller à bien comprendre le manuel d'utilisation avant d'employer ce produit.

Merci de votre achat.

Su sopladora ha sido diseñado y fabricado de conformidad con nuestras estrictas normas para brindar fiabilidad, facilidad de uso y seguridad para el operador. Con el debido cuidado, le brindará muchos años de sólido funcionamiento y sin problemas.

⚠ ADVERTENCIA:
Para reducir el riesgo de lesiones, el usuario debe leer y comprender el manual del operador antes de usar este producto.

Le agradecemos su compra.

**CONSERVER CE MANUEL POUR
FUTURE RÉFÉRENCE**

**GUARDE ESTE MANUAL PARA
FUTURAS CONSULTAS**

TABLE OF CONTENTS

TABLE DES MATIÈRES / ÍNDICE DE CONTENIDO

■ Introduction	2
Introduction / Introducción	
■ Important Safety Instructions	3-4
Règles de sécurité importantes / Instrucciones importantes de seguridad	
■ Symbols.....	5-6
Symboles / Símbolos	
■ Features.....	6
Caractéristiques / Características	
■ Assembly	7
Assemblage / Armado	
■ Operation.....	8-9
Utilisation / Funcionamiento	
■ Maintenance.....	9
Entretien / Mantenimiento	
■ Warranty	10
Garantie / Garantía	
■ Parts Ordering and Service	Back Page
Commande de pièces et réparation / Pedidos de piezas y servicio	Page arrière / Pág. posterior

INTRODUCTION

INTRODUCTION / INTRODUCCIÓN

This product has many features for making its use more pleasant and enjoyable. Safety, performance, and dependability have been given top priority in the design of this product making it easy to maintain and operate.

* * *

Ce produit offre de nombreuses fonctions destinées à rendre son utilisation plus plaisante et satisfaisante. Lors de la conception de ce produit, l'accent a été mis sur la sécurité, les performances et la fiabilité, afin d'en faire un outil facile à utiliser et à entretenir.

* * *

Este producto ofrece numerosas características para hacer más agradable y placentero su uso. En el diseño de este producto se ha conferido prioridad a la seguridad, el desempeño y la fiabilidad, por lo cual se facilita su manejo y mantenimiento.

IMPORTANT SAFETY INSTRUCTIONS

When using an electrical appliance, basic precautions should always be followed, including the following:

WARNING!

READ AND UNDERSTAND ALL INSTRUCTIONS BEFORE USING THIS BLOWER. To reduce the risk of electric shock, fire and/or serious personal injury.



- **Know your power blower. Read operator's manual carefully. Learn its applications and limitations, as well as the specific potential hazards related to this blower.** Following this rule will reduce the risk of electric shock, fire, or serious injury.
- **Do not permit children to use blower.** It is not a toy. Close attention is necessary when used near children.
- **Use only accessories that are recommended by the manufacturer for your model described in this manual.** Accessories that may be suitable for one blower may create a risk of injury when used on another blower. **Use only as described in this manual.**
- **Do not handle charger, including charger plug, and charger terminals with wet hands.**
- **Do not put any object into openings. Do not use with any opening blocked; keep free of dust, lint, hair, and anything that may reduce air flow.**
- **Do not charge the unit outdoors.**
- **Keep hair, loose clothing, fingers, and all parts of body away from openings and moving parts.**
- **Turn off all controls before removing battery.**
- **Use extra care when cleaning on stairs or steps.**
- **Do not operate blowers in explosive atmospheres, such as in the presence of flammable liquids, gases, or dust.** Blowers create sparks which may ignite the dust or fumes.
- **Keep your work area clean and well lit.** Cluttered benches and dark areas invite accidents.
- **Keep bystanders, children, and visitors at least 50 ft. away while operating a blower.** Distractions can cause you to lose control.
- **A battery operated blower with integral batteries or a separate battery pack must be recharged only with the specified charger for the battery.** A charger that may be suitable for one type of battery may create a risk of fire when used with another battery.
- **Use battery operated blower only with specifically designated battery pack.** Use of any other batteries may create a risk of fire.
- **Use only with charger listed.** For use with 40V lithium-ion battery packs, see tool/appliance/battery pack/charger correlation supplement 988000-842.
- **Do not operate **charger** with a damaged cord or plug, which could cause shorting and electric shock.** If damaged, have the charger replaced by an authorized service center.
- **If appliance is not working as it should, has been dropped, damaged, left outdoors, or dropped into water, return it to a service center.**
- **Stay alert, watch what you are doing and use common sense when operating a power blower. Do not use blower while tired, upset, or under the influence of drugs, alcohol, or medication.** A moment of inattention while operating blowers may result in serious personal injury.
- **Secure long hair above shoulder level to prevent entanglement in moving parts.**
- **Avoid accidental starting. Be sure switch is in the locked or off position before inserting battery pack.** Carrying blowers with your finger on the switch or inserting the battery pack into a blower with the switch on invites accidents.
- **Use safety equipment. Always wear eye protection.** Dust mask, non-skid safety shoes, hard hat, or hearing protection must be used for appropriate conditions.
- **Do not wear loose clothing or jewelry. Contain long hair.** Loose clothes, jewelry, or long hair can be drawn into air vents.
- **Do not use on a ladder, rooftop, tree, or other unstable support.** Stable footing on a solid surface enables better control of the blower in unexpected situations.
- **Do not use blower if switch does not turn it on or off.** A blower that cannot be controlled with the switch is dangerous and must be repaired.
- **Disconnect battery pack from blower or place the switch in the locked or off position before making any adjustments, changing accessories, or storing the blower.** Such preventive safety measures reduce the risk of starting the blower accidentally.
- **When battery pack is not in use, keep it away from other metal objects like: paper clips, coins, keys, nails, screws, or other small metal objects that can make a connection from one terminal to another.** Shorting the battery terminals together may cause sparks, burns, or a fire.
- **Check for misalignment or binding of moving parts, breakage of parts, and any other condition that may affect the blower's operation. If damaged, have the blower serviced before using.** Many accidents are caused by poorly maintained blowers.
- **Keep the blower and its handle dry, clean and free from oil and grease.** Always use a clean cloth when cleaning. Never use brake fluids, gasoline, petroleum-based products, or any strong solvents to clean your blower. Following this rule will reduce the risk of loss of control and deterioration of the enclosure plastic.

IMPORTANT SAFETY INSTRUCTIONS











- **Always wear safety glasses with side shields.** Everyday glasses have only impact resistant lenses. They are NOT safety glasses. Following this rule will reduce the risk of eye injury.
- **Always wear eye protection with side shields marked to comply with ANSI Z87.1 along with hearing protection when operating this equipment.**
- **Protect your lungs. Wear a face or dust mask if the operation is dusty.** Following this rule will reduce the risk of serious personal injury.
- **Protect your hearing. Wear hearing protection during extended periods of operation.** Following this rule will reduce the risk of serious personal injury.
- **Battery blowers do not have to be plugged into an electrical outlet; therefore, they are always in operating condition. Be aware of possible hazards when not using your battery powered blower or when changing accessories.** Following this rule will reduce the risk of electric shock, fire, or serious personal injury.
- **Do not place battery powered blowers or their batteries near fire or heat.** This will reduce the risk of explosion and possibly injury.
- **Don't expose blowers to rain or wet conditions.** Water entering a blower will increase the risk of electric shock.
- **Wear heavy long pants, long sleeves, boots, and gloves.** Avoid loose garments or jewelry that could get caught in moving parts of the machine or its motor.
- **Do not operate the equipment while barefoot or when wearing sandals or similar lightweight footwear.** Wear protective footwear that will protect your feet and improve your footing on slippery surfaces.
- **Keep firm footing and balance. Do not overreach.** Overreaching can result in loss of balance.
- **Check the work area before each use.** Remove all objects such as rocks, broken glass, nails, wire, or string which can be thrown or become entangled in the machine.
- **Do not point the blower nozzle in the direction of people or pets.**
- **Never run the unit without the proper equipment attached.** Always ensure the blower tubes are installed.
- **When not in use, blower should be stored indoors in a dry, locked up place—out of the reach of children.**
- **Do not hang unit so that the switch trigger is depressed.**
- **Keep all bystanders, children, and pets at least 50 ft. away.**
- **Do not dispose of a severely damaged or worn out battery pack or this blower by incinerating.** The battery can explode in fire.
- **Blower service must be performed only by qualified repair personnel.** Service or maintenance performed by unqualified personnel may result in a risk of injury.
- **When servicing a blower, use only identical replacement parts.** Follow instructions in the Maintenance section of this manual. Use of unauthorized parts or failure to follow Maintenance Instructions may create a risk of shock or injury.
- **Never use blower near fires, fireplaces, hot ashes, barbecue pits, etc.** Use near fires or ashes can spread fires and result in serious injury and/or property damage.
- **Never use blower to spread chemicals, fertilizers, or any other toxic substances.** Spreading these substances could result in serious injury to the operator or bystanders.
- **Never place blower on any surface, except a hard, clean surface when motor is running.** Gravel, sand, and other debris can be picked up by the air inlet and thrown at the operator or bystanders, causing possible serious injuries.
- **For household use only.**
- **Save these instructions.** Refer to them frequently and use them to instruct others who may use this tool. If you loan someone this tool, loan them these instructions also.

SYMBOLS

The following signal words and meanings are intended to explain the levels of risk associated with this product.

SYMBOL	SIGNAL	MEANING
	DANGER:	Indicates an imminently hazardous situation, which, if not avoided, will result in death or serious injury.
	WARNING:	Indicates a potentially hazardous situation, which, if not avoided, could result in death or serious injury.
	CAUTION:	Indicates a potentially hazardous situation, which, if not avoided, may result in minor or moderate injury.
	NOTICE:	(Without Safety Alert Symbol) Indicates important information not related to an injury hazard, such as a situation that may result in property damage.

Some of the following symbols may be used on this product. Please study them and learn their meaning. Proper interpretation of these symbols will allow you to operate the product better and safer.

SYMBOL	NAME	DESIGNATION/EXPLANATION
	Safety Alert	Indicates a potential personal injury hazard.
	Read Operator's Manual	To reduce the risk of injury, user must read and understand operator's manual before using this product.
	Eye and Hearing Protection	Always wear eye protection with side shields marked to comply with ANSI Z87.1 along with hearing protection when operating this equipment.
	Impeller Blades	Rotating impeller blades can cause severe injury.
	Wet Conditions Alert	Do not expose to rain or use in damp locations.
	Keep Bystanders Away	Keep all bystanders at least 50 ft. away.
	Long Hair	Failure to keep long hair away from the air inlet could result in personal injury.
	Blower Tube	Do not operate without tube in place.
	Loose Clothing	Failure to keep loose clothing from being drawn into air intake could result in personal injury.
	Ricochet	Thrown objects can ricochet and result in personal injury or property damage.
	Recycle Symbol	This product uses lithium-ion (Li-ion) batteries. Local, state, or federal laws may prohibit disposal of batteries in ordinary trash. Consult your local waste authority for information regarding available recycling and/or disposal options.

SYMBOLS

Some of the following symbols may be used on this product. Please study them and learn their meaning. Proper interpretation of these symbols will allow you to operate the product better and safer.

SYMBOL	NAME	DESIGNATION/EXPLANATION
V	Volts	Voltage
min	Minutes	Time
≡	Direct Current	Type or a characteristic of current
n_0	No Load Speed	Rotational speed, at no load
.../min	Per Minute	Revolutions, strokes, surface speed, orbits etc., per minute

FEATURES

PRODUCT SPECIFICATIONS

Motor 40 Volts DC
 Air Velocity 325 CFM
 Weight (without battery pack) 4.1 lbs

KNOW YOUR BLOWER

See Figure 1.

The safe use of this product requires an understanding of the information on the tool and in this operator's manual as well as a knowledge of the project you are attempting. Before use of this product, familiarize yourself with all operating features and safety rules.

BLOWER TUBE

The blower tube can be installed on the blower without using any tools.

OVERMOLD HANDLE

Ergonomic handle with overmold improves comfort and grip.

ASSEMBLY

UNPACKING

This product requires assembly.

- Carefully remove the product and any accessories from the box. Make sure that all items listed in the packing list are included.

WARNING:

Do not use this product if any parts on the Packing List are already assembled to your product when you unpack it. Parts on this list are not assembled to the product by the manufacturer and require customer installation. Use of a product that may have been improperly assembled could result in serious personal injury.

- Inspect the product carefully to make sure no breakage or damage occurred during shipping.
- Do not discard the packing material until you have carefully inspected and satisfactorily operated the product.
- If any parts are damaged or missing, please call 1-800-860-4050 for assistance.

PACKING LIST

Blower

Blower Tube

Operator's Manual

WARNING:

If any parts are damaged or missing do not operate this product until the parts are replaced. Use of this product with damaged or missing parts could result in serious personal injury.

WARNING:

Do not attempt to modify this product or create accessories not recommended for use with this blower. Any such alteration or modification is misuse and could result in a hazardous condition leading to possible serious personal injury.

WARNING:

To prevent accidental starting that could cause serious personal injury, always remove the battery pack from the tool when assembling parts.

ASSEMBLING THE BLOWER TUBE

See Figure 2.

- With the logo area facing up, slide the blower tube over the outlet on the blower housing.
- Press down on the tab on the blower housing outlet.
- Push tube on the blower housing outlet until tab locks into place through the slot in the blower tube.
- To remove the blower tube, push tab down and slide tube off.

OPERATION

WARNING:

Do not allow familiarity with products to make you careless. Remember that a careless fraction of a second is sufficient to inflict serious injury.

WARNING:

Always wear eye protection with side shields marked to comply with ANSI Z87.1, along with hearing protection. Failure to do so could result in objects being thrown into your eyes resulting in possible serious injury.

WARNING:

Do not use any attachments or accessories not recommended by the manufacturer of this product. The use of attachments or accessories not recommended can result in serious personal injury.

APPLICATIONS

You may use this product for the purposes listed below:

- Clearing hard surfaces such as driveways and walkways
- Keeping decks and driveways free from leaves and pine needles

This product will accept Ryobi 40 V lithium-ion battery packs.

For complete charging instructions, refer to the Operator's Manuals for your Ryobi battery pack and charger models.

BATTERY PROTECTION FEATURES

Ryobi lithium-ion batteries are designed with features that protect the lithium-ion cells and maximize battery life.

If the tool stops during use, release the trigger to reset and resume operation. If the tool still does not work, the battery needs to be recharged.

TO INSTALL/REMOVE BATTERY PACK

See Figure 3.

WARNING:

Always remove battery pack from your tool when you are assembling parts, making adjustments, cleaning, or when not in use. Removing battery pack will prevent accidental starting that could cause serious personal injury.

To install:

- Place the battery pack in the blower. Align the raised rib on the battery pack with groove in the blower's battery port.

WARNING:

Make sure the latch on the bottom of the battery pack snaps in place and the battery pack is fully seated and secure in the blower battery port before beginning operation. Failure to securely seat the battery pack could cause the battery pack to fall out, resulting in serious personal injury.

NOTICE:

When placing battery pack in the tool, be sure raised rib on battery pack aligns with the bottom of the tool and latches into place properly. Improper installation of the battery pack can cause damage to internal components.

To remove:

- Locate the latch on the bottom of the battery pack and depress to release the battery pack from the blower.

WARNING:

Battery tools are always in operating condition. Therefore, switch should always be in the OFF position when not in use or carrying at your side. Remove battery pack when transporting or carrying blower to avoid accidental starting, which could result in serious injury.

STARTING/STOPPING THE BLOWER

See Figure 4.

- To start the blower, depress the switch trigger.
- To stop the blower, release the switch trigger.

OPERATION

OPERATING THE BLOWER

See Figure 5.

- To keep from scattering debris, blow around the outer edges of a debris pile. Never blow directly into the center of a pile.
- To reduce sound levels, limit the number of pieces of equipment used at any one time.
- Use rakes and brooms to loosen debris before blowing. In dusty conditions, slightly dampen surfaces when water is available.
- Conserve water by using power blowers instead of hoses for many lawn and garden applications, including areas such as gutters, screens, patios, grills, porches, and gardens.

- Watch out for children, pets, open windows, or freshly washed cars, and blow debris safely away.
- After using blowers or other equipment, CLEAN UP! Dispose of debris properly.

WARNING:

Battery tools are always in operating condition. Therefore, switch should always be in the OFF position when not in use or carrying at your side.

MAINTENANCE

WARNING:

When servicing, use only identical replacement parts. Use of any other parts can create a hazard or cause product damage.

WARNING:

Always wear eye protection with side shields marked to comply with ANSI Z87.1, along with hearing protection. Failure to do so could result in objects being thrown into your eyes resulting in possible serious injury.

WARNING:

To avoid serious personal injury, always remove the battery pack from the product when cleaning or performing any maintenance.

GENERAL MAINTENANCE

Avoid using solvents when cleaning plastic parts. Most plastics are susceptible to damage from various types of commercial solvents and may be damaged by their use. Use clean cloths to remove dirt, dust, oil, grease, etc.

WARNING:

Do not at any time let brake fluids, gasoline, petroleum-based products, penetrating oils, etc., come in contact with plastic parts. Chemicals can damage, weaken or destroy plastic which can result in serious personal injury.

Only the parts shown on the parts list are intended to be repaired or replaced by the customer. All other parts should be replaced at an Authorized Service Center.

STORAGE

- Clean all foreign material from the blower.
- Store indoors in a secure place that is inaccessible to children. Keep away from corrosive agents such as garden chemicals and de-icing salts.
- Do not hang unit so that the switch trigger is depressed.

BATTERY PACK REMOVAL AND PREPARATION FOR RECYCLING

WARNING:

Upon removal, cover the battery pack's terminals with heavy-duty adhesive tape. Do not attempt to destroy or disassemble battery pack or remove any of its components. Lithium-ion and nickel-cadmium batteries must be recycled or disposed of properly. Also, never touch both terminals with metal objects and/or body parts as short circuit may result. Keep away from children. Failure to comply with these warnings could result in fire and/or serious injury.

WARRANTY

LIMITED WARRANTY STATEMENT

Techtronic Industries North America, Inc., warrants to the original retail purchaser that this RYOBI® brand outdoor product is free from defect in material and workmanship and agrees to repair or replace, at Techtronic Industries North America, Inc.'s, discretion, any defective product free of charge within these time periods from the date of purchase.

- Three years if the product is used for personal, family or household use;
- 90 days, if used for any other purpose, such as commercial or rental.

This warranty extends to the original retail purchaser only and commences on the date of the original retail purchase.

Any part of this product found in the reasonable judgment of Techtronic Industries North America, Inc. to be defective in material or workmanship will be repaired or replaced without charge for parts and labor by an authorized service center for RYOBI® brand outdoor products (Authorized Ryobi Service Center).

The product, including any defective part, must be returned to an authorized Ryobi service center within the warranty period. The expense of delivering the product to the service center for warranty work and the expense of returning it back to the owner after repair or replacement will be paid by the owner. Techtronic Industries North America, Inc.'s, responsibility in respect to claims is limited to making the required repairs or replacements and no claim of breach of warranty shall be cause for cancellation or rescission of the contract of sale of any RYOBI® brand outdoor product. Proof of purchase will be required by the dealer to substantiate any warranty claim. All warranty work must be performed by an authorized service dealer.

This warranty is limited to ninety (90) days from the date of original retail purchase for any RYOBI® brand outdoor product that is used for rental or commercial purposes, or any other income-producing purpose.

This warranty does not cover any product that has been subject to misuse, neglect, negligence, or accident, or that has been operated in any way contrary to the operating instructions as specified in this operator's manual. This warranty does not apply to any damage to the product that is the result of improper maintenance or to any product that has been altered or modified. The warranty does not extend to repairs made necessary by normal wear or by the use of parts or accessories which are either incompatible with the RYOBI® brand outdoor product or adversely affect its operation, performance, or durability. In addition, this warranty does not cover:

- A. Tune-ups – Spark Plugs, Carburetor, Carburetor Adjustments, Ignition, Filters
- B. Wear items – Bump Knobs, Outer Spools, Cutting Lines, Inner Reels, Starter Pulleys, Starter Ropes, Drive Belts, Tines, Felt Washers, Hitch Pins, Mulching Blades, Blower Fans, Blower and Vacuum Tubes, Vacuum Bag and Straps, Guide Bars, Saw Chains

Techtronic Industries North America, Inc., reserves the right to change or improve the design of any RYOBI® brand outdoor product without assuming any obligation to modify any product previously manufactured.

ALL IMPLIED WARRANTIES ARE LIMITED IN DURATION TO THE STATED WARRANTY PERIOD. ACCORDINGLY, ANY SUCH IMPLIED WARRANTIES INCLUDING MERCHANTABILITY, FITNESS FOR A PARTICULAR PURPOSE, OR OTHERWISE, ARE DISCLAIMED IN THEIR ENTIRETY AFTER THE EXPIRATION OF THE APPROPRIATE THREE-YEAR OR NINETY-DAY WARRANTY PERIOD. TECHTRONIC INDUSTRIES NORTH AMERICA, INC.'S, OBLIGATION UNDER THIS WARRANTY IS STRICTLY AND EXCLUSIVELY LIMITED TO THE REPAIR OR REPLACEMENT OF DEFECTIVE PARTS AND TECHTRONIC INDUSTRIES NORTH AMERICA, INC., DOES NOT ASSUME OR AUTHORIZE ANYONE TO ASSUME FOR THEM ANY OTHER OBLIGATION. SOME STATES DO NOT ALLOW LIMITATIONS ON HOW LONG AN IMPLIED WARRANTY LASTS, SO THE ABOVE LIMITATION MAY NOT APPLY TO YOU. TECHTRONIC INDUSTRIES NORTH AMERICA, INC., ASSUMES NO RESPONSIBILITY FOR INCIDENTAL, CONSEQUENTIAL, OR OTHER DAMAGES INCLUDING, BUT NOT LIMITED TO, EXPENSE OF RETURNING THE PRODUCT TO AN AUTHORIZED RYOBI SERVICE CENTER AND EXPENSE OF DELIVERING IT BACK TO THE OWNER, MECHANIC'S TRAVEL TIME, TELEPHONE OR TELEGRAM CHARGES, RENTAL OF A LIKE PRODUCT DURING THE TIME WARRANTY SERVICE IS BEING PERFORMED, TRAVEL, LOSS OR DAMAGE TO PERSONAL PROPERTY, LOSS OF REVENUE, LOSS OF USE OF THE PRODUCT, LOSS OF TIME, OR INCONVENIENCE. SOME STATES DO NOT ALLOW THE EXCLUSION OR LIMITATION OF INCIDENTAL OR CONSEQUENTIAL DAMAGES, SO THE ABOVE LIMITATION OR EXCLUSION MAY NOT APPLY TO YOU.

This warranty gives you specific legal rights, and you may also have other rights which vary from state to state.

This warranty applies to all RYOBI® brand outdoor products manufactured by or for Techtronic Industries North America, Inc., and sold in the United States and Canada.

To locate your nearest Authorized Ryobi Service Center, dial 1-800-860-4050.



OPERATOR'S MANUAL
MANUEL D'UTILISATION / MANUAL DEL OPERADOR
40 VOLT BLOWER
SOUFFLANTE 40 V / SOPLADORA DE 40 V
RY40402

CALIFORNIA PROPOSITION 65

⚠ WARNING:
 This product and substances that may become airborne from its use may contain chemicals, including lead, known to the State of California to cause cancer, birth defects, or other reproductive harm. *Wash hands after handling.*

PROPOSITION 65 DE L'ÉTAT DE CALIFORNIE

⚠ AVERTISSEMENT:
 Ce produit et les autres substances rejetées dans l'air suite à son utilisation peuvent contenir des produits chimiques, notamment du plomb qui, selon l'État de la Californie, peuvent causer le cancer, des anomalies congénitales et d'autres dommages au système reproducteur. *Bien se laver les mains après toute manipulation.*

CALIFORNIA - PROPUESTA DE LEY NÚM. 65

⚠ ADVERTENCIA:
 Este producto y las sustancias que puedan llegar a ser aerotransportadas por su uso pueden contener sustancias químicas (incluido el plomo) reconocidas por el estado de California como causantes de cáncer, defectos congénitos y otras afecciones del aparato reproductor. *Lávese las manos después de utilizar el aparato.*

RYOBI is a registered trademark of Ryobi Limited and is used pursuant to a license granted by Ryobi Limited.

RYOBI est une marque déposée de Ryobi Limited et est utilisée en vertu d'une licence accordée par Ryobi Limited.

RYOBI es una marca registrada de Ryobi Limited y se utiliza conforme a una licencia otorgada por Ryobi Limited.

- **PARTS AND SERVICE**
 Prior to requesting service or purchasing replacement parts, please obtain your model and serial number from the product data plate.
- **MODEL NO.** _____ **SERIAL NO.** _____
- **HOW TO OBTAIN REPLACEMENT PARTS:**
 Replacement parts can be purchased online at www.ryobitools.com or by calling 1-800-860-4050. Replacement parts can also be obtained at one of our Authorized Service Centers.
- **HOW TO LOCATE AN AUTHORIZED SERVICE CENTER:**
 Authorized Service Centers can be located online at www.ryobitools.com or by calling 1-800-860-4050.
- **HOW TO OBTAIN CUSTOMER OR TECHNICAL SUPPORT:**
 To obtain Customer or Technical Support please contact us at 1-800-860-4050.

• • • • •

- **PIÈCES ET SERVICE**
 Avant de faire la demande de service ou l'achat de pièces de remplacement, veuillez obtenir le numéro de série du modèle à partir de la plaque de données du produit.
- **NUMÉRO DE MODÈLE** _____ **NUMÉRO DE SÉRIE** _____
- **COMMENT OBTENIR LES PIÈCES DE REMPLACEMENT :**
 Les pièces de remplacement peuvent être achetées en ligne sur le site www.ryobitools.com ou par téléphone au 1-800-860-4050. Les pièces de remplacement peuvent être obtenues à un de nos centres de service autorisés.
- **COMMENT TROUVER UN CENTRE DE SERVICE AUTORISÉ :**
 Les centres de service autorisés peuvent être localisés en ligne au www.ryobitools.com ou en téléphonant au 1-800-860-4050.
- **COMMENT OBTENIR DE L'AIDE EN CONTACTANT LE SERVICE À LA CLIENTÈLE :**
 Pour contacter le service à la clientèle pour une question technique ou pour tout autre renseignement, veuillez nous téléphoner au 1-800-860-4050.

• • • • •

- **PIEZAS DE REPUESTO Y SERVICIO**
 Antes de solicitar servicio técnico o comprar piezas de repuesto, obtenga su modelo y número de serie de la placa de datos del producto.
- **NÚMERO DE MODELO** _____ **NÚMERO DE SERIE** _____
- **CÓMO OBTENER PIEZAS DE REPUESTO:**
 Las piezas de repuesto se pueden comprar en nuestro sitio en la red mundial, en la dirección www.ryobitools.com o llamando al 1-800-860-4050. Las piezas de repuesto también se pueden obtener en uno de nuestros Centros de Servicio Autorizados.
- **CÓMO LOCALIZAR UN CENTRO DE SERVICIO AUTORIZADO:**
 Puede encontrar los Centros de Servicio Autorizados visitando nuestro sitio en la red mundial, en la dirección www.ryobitools.com or by calling 1-800-860-4050.
- **CÓMO OBTENER SERVICIO O ASISTENCIA TÉCNICA AL CONSUMIDOR:**
 Para obtener Servicio o Asistencia Técnica al Consumidor, sírvase comunicarse con nosotros llamando al 1-800-860-4050.