

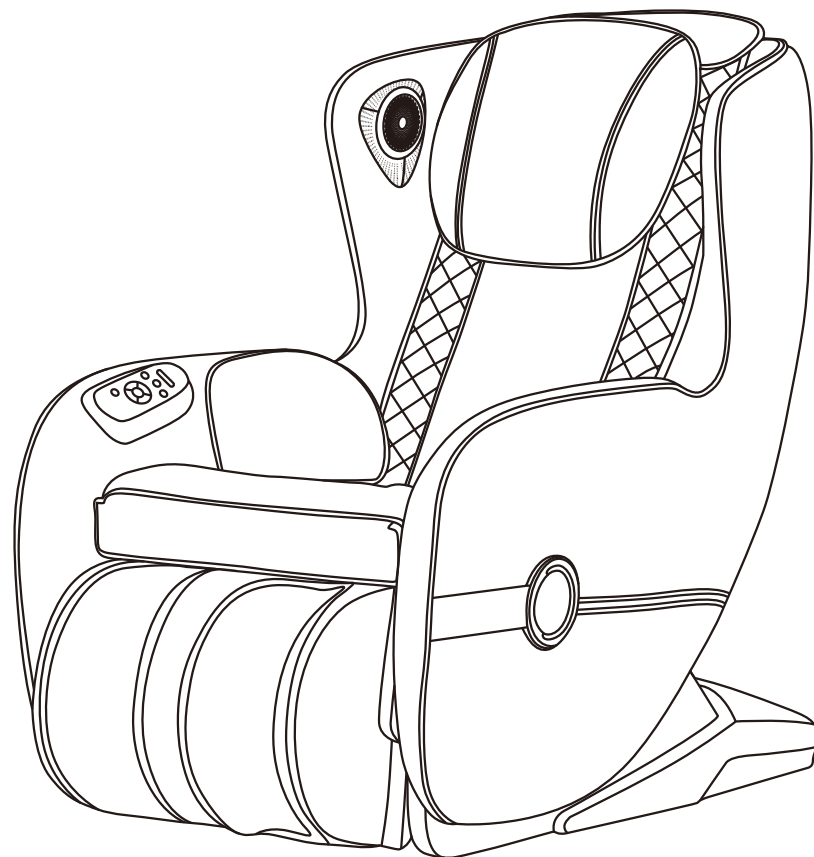

**Queen**  
A158 INTELLIGENT MASSAGE CHAIR

Operation Instructions

**SAVE THESE INSTRUCTIONS**



Thanks for purchasing this product. Please read this manual instruction carefully in order to know how to use this product correctly before operation. Please pay more attention to some important safety warning and keep this manual book properly for future use.

Note: Our Company reserves the right to revise the design and description of this product without any further notice. Please refer to the actual color of this product.

## **CONTENTS**

---

Safety and maintenance	02
Safety warning	04
Name and function of components	07
Function	08
Method of usage	09
Product specification	15

## Safety and maintenance

---

### 1. Important Safety Warning.



- Don't allow children to touch moveable part of this product.
- Please use well-grounding power supply suited to this product.
- Please pull out the plug after use or before cleaning to avoid injury or Damage to the product.
- Please operate this product according to this manual instruction.
- Don't use accessories which are not recommended.
- Don't use this product outdoors.
- Please read this manual instruction carefully before operation.
- Any other usage that is not listed in this manual instruction is forbidden.
- 20 minutes of usage each time is recommended.
- Please don't use it if the leather is broken or damaged.
- Please don't use it if the cover or leather is damaged.
- Please don't use it if the radiator hole is covered or blocked.
- Please don't drop anything into this product.
- Please don't fall asleep while using this product.
- Please don't use it if drunk or feel unwell.
- Please don't use it within one hour after having meal.
- Please don't make the massage function too strong for avoiding Injury.

### 2. Environment for usage.

- Please don't use it under high temperature and moist environment such as bathroom.
- Please don't use it immediately while the environmental temperature changes sharply.
- Please don't use it under heavy-dusty or caustic environment.
- Please don't use it where there is not enough space or not good ventilation.

### 3. People who are not suitable to use this product.

- People who are suffering from osteoporosis are not suitable to use this product.
- People who are suffering from heart disease or carrying electronic medical equipment such as heart pacemaker are not suitable to use this product.
- People who are suffering from fever are not suitable to use this product.
- Pregnant women or women that are in menses period are not suitable to use this product.
- People who got injured or skin disease are not suitable to use this product.
- Children under 14-year old or people mentally unbalanced without being Supervised are not allowed to use this machine.
- People who are told by doctor to have rest or people who feel unwell are not suitable to use this product.
- People whose bodies are wet are forbidden to use this product.

### 4. Safety.

- Check the voltage if it is suitable to the specification of this product.
- Don't use wet hand to pull the plug.
- Don't make water go inside this product to avoid electric shock or cause damage to this product.
- Don't damage the wires or change the circuit of this product.
- Don't use wet cloth to clean the electric parts such as switch and plug.

## Safety and maintenance

---

- Be away from this product under power cut state to avoid injury if the power comeback suddenly.
- Stop using this product while it works abnormal, and please consult local agent immediately.
- Stop using this product if you feel unwell, and please consult health care doctor.
- This appliance is not intended for use by persons (including children) with reduced physical, sensory or mental capabilities, or lack of experience and knowledge, unless they have been given supervision or instruction concerning use of the appliance by a person responsible for their safety.
- Children should be supervised to ensure that they do not play with the appliance.
- If the supply cord is damaged, it must be replaced by the manufacturer, its Service agent or similarly qualified persons in order to avoid a hazard.

### 5. Maintenance.

- This product should be maintained by certain appointed agents, users are prohibited to disassemble or maintain by themselves.
- Please don't forget to cut the power after usage.
- Don't use this product if the socket looses.
- If this product will be left unused for long, please curl up the wires and reserve this product in dry and dustless environment.
- Don't reserve this product under high temperature or near fire and avoid longtime direct sunshine.
- If the detachable cord / supply cord is damaged, it must be replaced by the manufacturer, its service agent or similarly qualified persons in order to avoid a Hazard.
- Please clean this product by dry cloth. Don't use thinner, benzene or alcohol.
- The mechanical components of this product are specially designed and made, it is not necessary to be specially maintained.
- Don't use edged res to thrust this product.
- Don't roll or pull this product above uneven ground, it should be lifted before moving.
- Please use it intermittently; don't make this product work continuously for long.

### 6. Solution of ordinary malfunctions.

- It is nature movement voice if the motor sounds while in usage.
- If the controller can't work normally, please check the plug and socket if they are connected strongly and make sure the switch is turned on.
- If the rated working time is over, the product will automatically activate the power-off button; If this product works continuously for long, the temperature protector will make the product automatically power-off, it should be used again after half an hour's rest.

## Safety warning

### ⚠ Warning

When the footrest lifting, people should not apply pressure on the footrest to avoid the massage chair falling forward to damage the product or cause personal injuries.

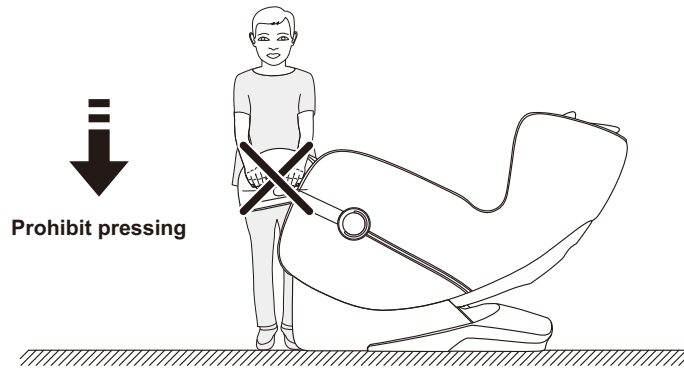

### ⚠ Warning

Before sitting on the massage chair, make sure that the massage hand stays in the seat cushion position to avoid discomfort to the buttocks during the body pressing down and damage to the massage hand.

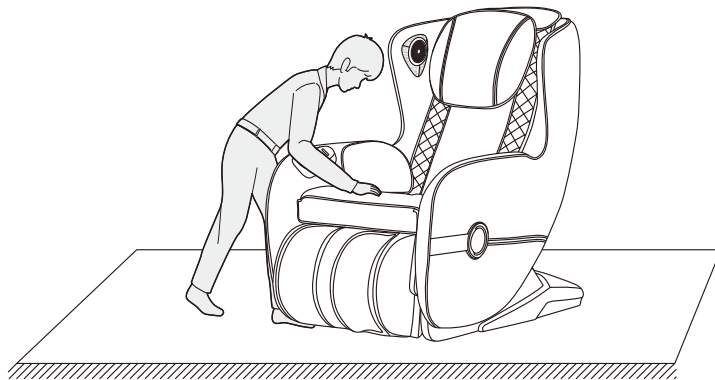

## Safety warning

### ⚠ Warning

Do not remove the power cord during standby or power-on state to avoid damage to the product or accidental electric shock. It is recommended to unplug the power cord when not in use.

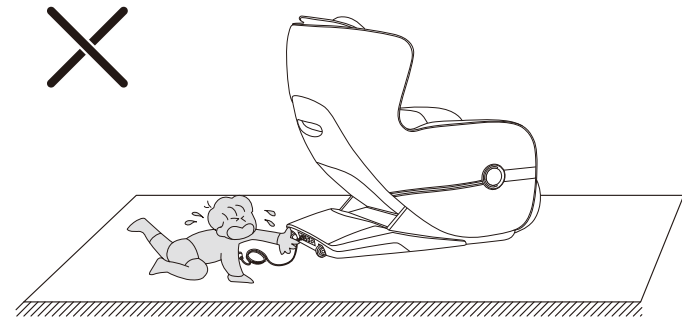

### ⚠ Warning

When start the zero gravity lying function, be sure to check whether there are children and pets under the bottom of the footrest and backrest, may cause the product damaged or personal injuries.

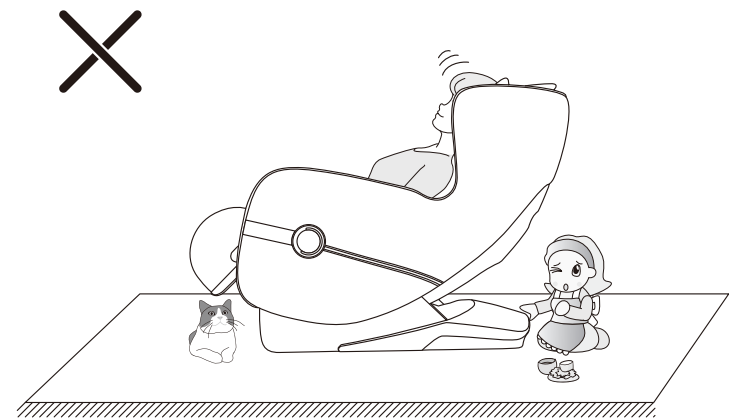

## Safety warning

### Warning

The chair is light, it's strictly prohibited that children do the high-risk movements such as climbing or stepping. Otherwise, the product may fall over and fall over to avoid product damage or personal injury

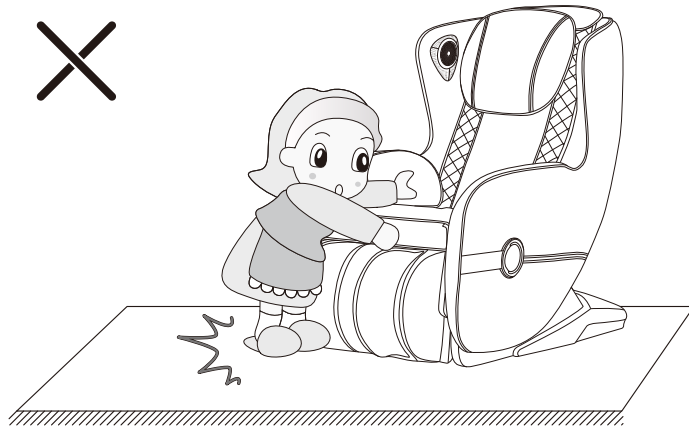

## Name and function of components

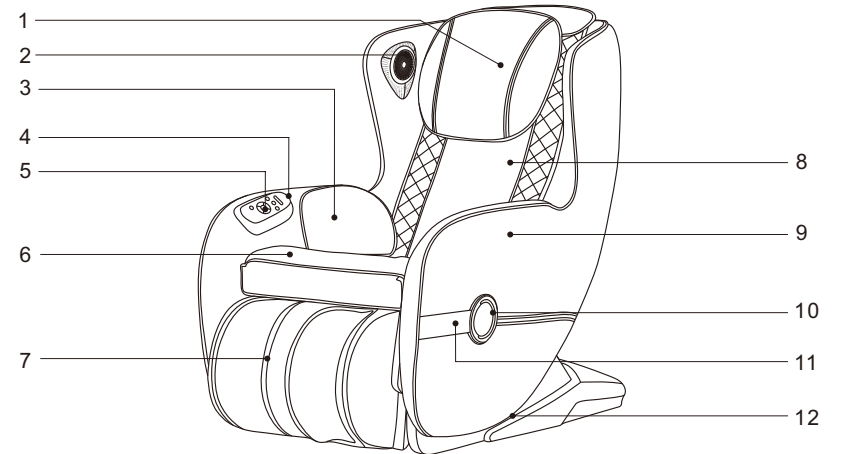

1. Pillow Pad
2. Bluetooth digital sound
3. Buttock airbag
4. USB charging jack
5. Control panel
6. Seat cushion
7. Calf rest
8. Back cushion
9. Armrest
10. Led light
11. Armrest decoration
12. Side panel
13. Back cover
14. Power cord and plug
15. Caster
16. Power socket
17. Power switch
18. Fuse box

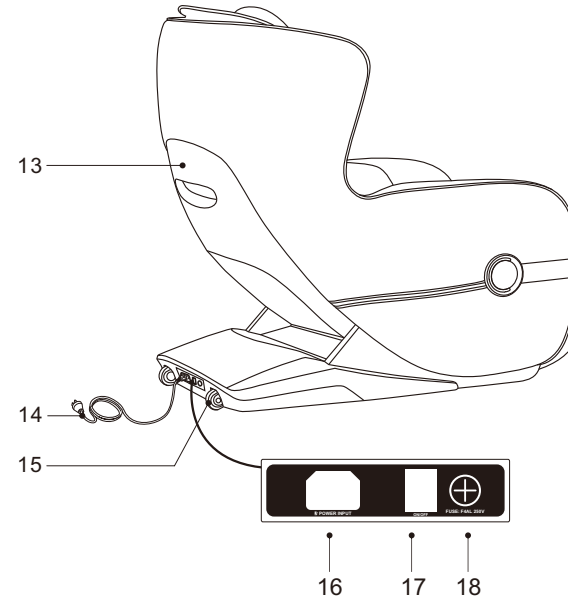

## Function

- This product is designed with a set of massage hand that can walk up and down, four-wheel drive and quiet design.
- There are five kinds of artificial massage techniques: kneading, tapping, kneading and tapping, knocking and shiatsu
- Equipped with Features automatic massage function: automatic mode 1 (full body care), automatic mode 2 (neck & shoulder care), automatic mode3 (back & waist stretch) three automatic modes.
- It has full body manual massage function (full range, upper body, lower body, partial, fixed point, five kinds of massage parts, kneading, tapping, kneading, tapping, shiatsu, five kinds of synchronous massage techniques; each massage technique has three speeds, and it can be adjusted. In the fixed point and partial state, the massage hand can adjust the position up and down. When tapping, shiatsu or tapping massage, the width of the massage ball is wide, medium and narrow.
- Equipped with airbag massage function: leg and hip pressure massage function, with two intensity.
- Blue LED lights are placed on the side of the armrest.
- A USB mobile phone charging interface is provided at the back of the control panel.
- Equipped With timing display function.
- The Bluetooth function of the smart device can be used to play music on a wireless connection.
- The music player system has a 3D digital sound on the left and right sides of the massage chair.
- With a 180° manual flip function for the calf, you can choose a leg pressure massage according to your needs.
- The lower leg frame and the back frame are linked to the lifting adjustment and the automatic lying mode adjustment function.
- The "SL" type long curved track fits the human back, and can enjoy a close-fitting massage from the neck to the thigh, and the zero-gravity state occurs when the backrest is lying down.
- Turnoff the machine, massage hand will automatic reset.

## Method of usage

**Note: The specific display is subject to the physical button light!**

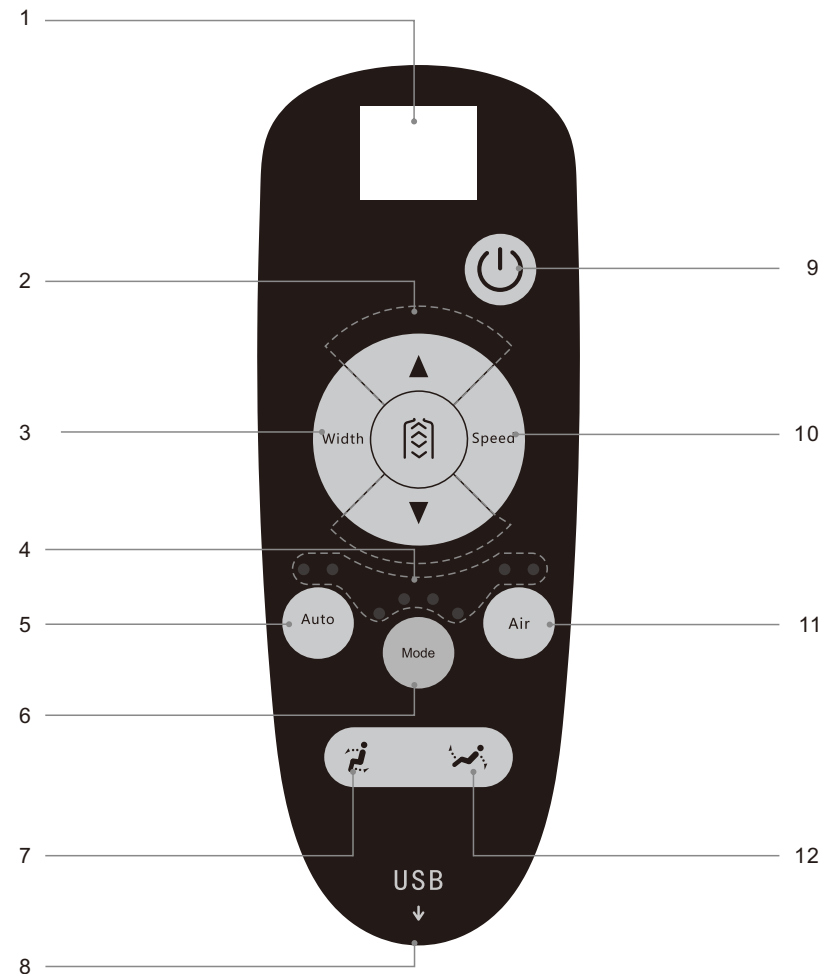

## Method of usage

### 1.LED display

- Display the massage mode and timing.

### 2.Massage range adjustment button.

- Refer to page 11 of this manual for details.

### 3.Width button

- Massage ball width adjustment

### 4.LED function display

- Massage function display

### 5.Automatic massage button

- Turn on/off the automatic massage function (refer to page 10 of this manual for details).

### 6.Manual Button.

- refer to page 10 of this manual for details.

### 7.Lifting button

- Adjust the position where the back frame rises and the lower leg frame.

### 8.USB socket

- USB phone charging socket

### 9.Power

- Turn on/off all massage functions

### 10.Speed

- Massage technique speed adjustment

### 11.Air pressure

- Turn on/off the automatic massage function (refer to page 11 of this manual for details).

### 12.recline

- Adjust the position where the back frame is lowered and the lower leg rest is raised.

## Method of usage

### 1.Switch power supply on



### 2.Start massage

- ①.Press the power button to start the massage and the massage chair will automatically recline.
- ②.When you hear “Bi Bi” (display HH), you can adjust to the shoulder position by the up and down buttons. Without adjustment within 5 seconds, the massage automatically starts.
- ③.The default into the Auto I mode, airbag massage is open, you can also choose other massage modes for massage.

#### A).Automatic massage



Name	Button	Massage feature	Display State
Automatic massage		Auto I: full body care, body massage, relaxing sore parts, relieve fatigue.	A1
		Auto II: Neck & shoulder care, with a focus on the back waist.	A2
		Auto III: The massage focus on the back & waist.	A3

#### B).Manual Massage

Name	Button	Massage feature	Display State
Mode		Kneading: The speed is adjustable; the indicator light I is on.	● ○ ○ ○
		Tapping: speed and width are adjustable; indicator light II is on	○ ● ○ ○
		Kneading and tapping: The speed is adjustable; the indicator light III is on.	○ ○ ● ○
		Knocking: Speed and width are adjustable; indicator light IV is on	○ ○ ○ ●
		Shiatsu: speed and width are adjustable; indicator light I flashes.	● ○ ○ ○
		Tapping 1: Speed adjustable; indicator light II flashes.	○ ● ○ ○
Width Button		Three intensity adjusted	D1、D2、D3
Speed Button		Three speed adjusted	P1、P2、P3

## Method of usage



### C).Massage area adjustment

Name	Button	Description	Display State
Massage area		Fixed point: fixed position massage.	H0
		Partial: Small area partial massage.	H1
		Upper body: upper body massage.	H2
		Lower body: lower body massage.	H3
		Full Body :Full body massage.	H4
Up Button		Massage position adjustment (in fixed point, partial mode, you can use the up and down buttons Key to adjust the massage position).	Massage hand upside
Down Button			Massage hand downside

### D).Air pressure massage

Name	Button	Description
Air pressure		Press this button to select the air pressure function: weak, strong, and closed.

### E). The position of back frame adjustment

Name	Button	Description
Lifting Button		Press and hold this button, the backrest frame rises slowly, the calf frame slowly descends, and the release stops. If you sit up to the top, stop rising
Recline button		Press and hold this button, the backrest frame will slowly recline, the calf frame will rise slowly, if released the button will stop. There is the maximum.

### 3.Bluetooth audio playback operation instructions

1. Enter the smart device main menu, open "Settings"--Select "Bluetooth" option-- Open "Bluetooth"— Bluetooth, Automatically "search for new Bluetooth devices" to search.
2. The smart device will search for the corresponding Bluetooth model (such as IMCM-XXXX) and click Connect.
3. Open the music player of the smart device and select the song to play.

## Method of usage

### 4.Turn off the power, end the massage

- 1.During the massage process, press the red power switch to immediately turn off the chair, the chair and massage hand automatic reset.
- 2.Message time is up (20 minutes), stop all massage, the massage hand reset.
- 3.After the reset, the chair cut off the power.



### 5.Method of calf flip

- 1.When using the calf flip function, first flip the calf to the intersection with the calf beam tube (the stuck cannot be rotated)Such as (Figure 1).
- 2.then pull the calf forward 5cm and then flip down (Figure 2), when the calf is turned back, the opposite.

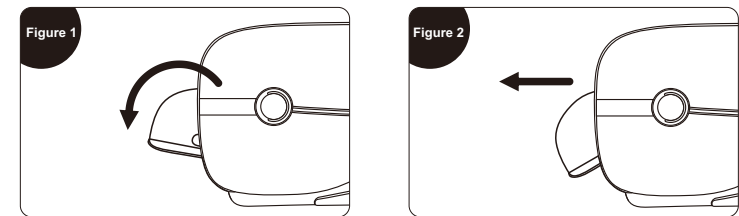

### 6.Moving method

- When carrying the massage chair, you need two people, one lift it by back of the back cover frame and other people carry the chair calf frame, lifted massage chair at the same time (PLEASE NOTE: Do not carry armrest to move the chair, the chair is too heavy carried by armrest. If the armrest damage, the chair will drop to cause the people injured).

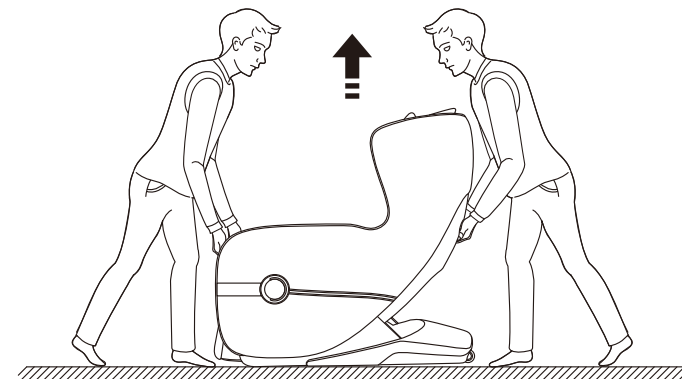



## Method of usage

### 7. Floor Protection

- Put the heavy massage chairs on the wood floor for a may damage the floor, so please place a carpet or other object to avoid this damage.

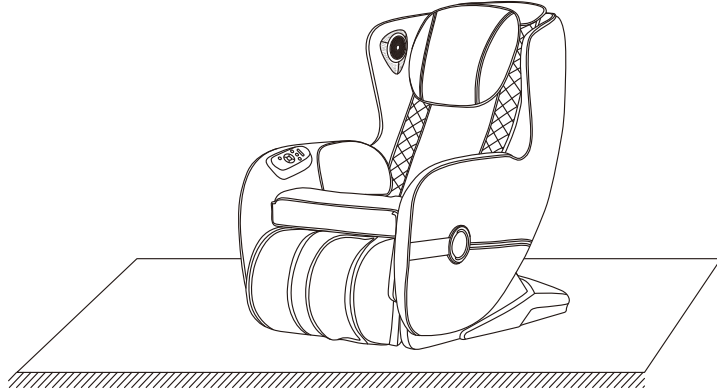

Caution: Do not use the caster to move the chair on the uneven ground and the small space. If you want to move, you need two people, one lift it by back of the back cover frame and other people carry the chair calf frame, lifted massage chair at the same time (PLEASE NOTE: Do not carry armrest to move the chair, the chair is too heavy carried by armrest. If the armrest damage, the chair will drop to cause the people injured).

### 8. Method of movement

- Make sure that all wires are far above the ground, tilt the backrest backward to a certain degree (with the gravity center resting on the wheels), push the chair forward or backward with your hands and finally resume the chair to the normal position in a slow and gentle manner.

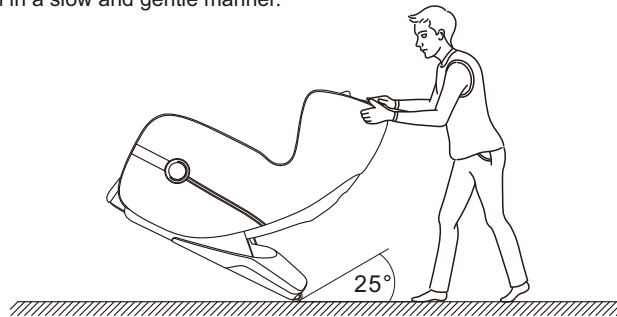

Note

During movement you must turn off the power first and then unplug the power cord and the controller cord.

## Product specification

Model: A158

Name: Massage Chair

Rated voltage: 110-120V~ 60Hz   
 220-240V~ 50Hz/60Hz

Rated power input: 60W

Rated time: 20Min

Safety structure: Class I

Material introduction: PVC, PA, steel parts and electric & electron parts

MATERIAL	PU	LEATHER	CLOTH	WOOD

