

Installation Support • Soporte de instalación • Support d'installation

Personal Assistance, Product Specs, & "How-to" Questions:

Asistencia personal, especificaciones del producto y preguntas sobre "cómo hacerlo":

Aide personnelle, spécifications du produit et questions "pratico-pratiques":

1-800-PFAUCET (732-8238)

pfisterfaucets.com/support

Installation Videos Available
Videos de instalación a disposición
Vidéos d'installation disponibles



pfisterfaucets.com/videos

! WARNING / ADVERTENCIA / AVERTISSEMENT

To reduce the risk of injury or property damage, read all instructions before installing product. Wear safety goggles. Product must be installed in accordance with all state & local plumbing & building codes. Call a professional if you are uncertain about installing this product.

Para disminuir el riesgo de lesiones o daños a la propiedad, lea todas las instrucciones antes de instalar el producto. Utilice gafas de seguridad. El producto deberá instalarse de acuerdo con la normativa de plomería y construcción estatal y local. Llame a un profesional si no está seguro sobre cómo instalar este producto.

Pour réduire le risque de blessures ou de dommages, lire toutes les instructions avant d'installer le produit. Portez des lunettes de sécurité. Il faut installer le produit en respectant tous les codes de construction et de plomberie locaux et d'état. Appelez un professionnel si vous n'êtes pas certain de la façon d'installer ce produit.

**Required Tools
Herramientas necesarias
Outils nécessaires**

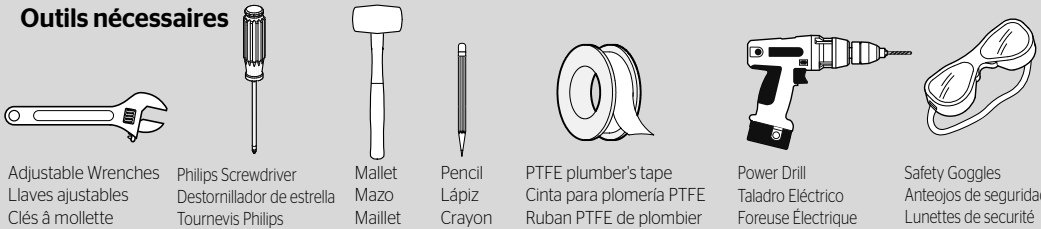

Adjustable Wrenches
Llaves ajustables
Clés à molette

Philips Screwdriver
Destornillador de estrella
Tournevis Phillips

Mallet
Mazo
Maillet

Pencil
Lápiz
Crayon

PTFE plumber's tape
Cinta para plomería PTFE
Ruban PTFE de plombier

Power Drill
Taladro Eléctrico
Foreuse Électrique

Safety Goggles
Anteojos de seguridad
Lunettes de sécurité

**Additional Helpful Tools
Otras herramientas útiles
Outils supplémentaires utiles**

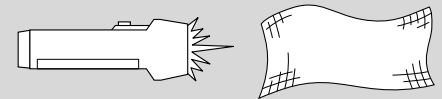

Flashlight
Linterna
Lampe de poche

Cloth
Paño de limpieza
Chiffon

**Parts in the Box
Piezas en la caja
Pièces dans la boîte**

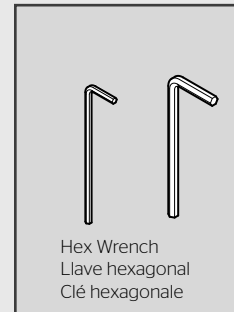
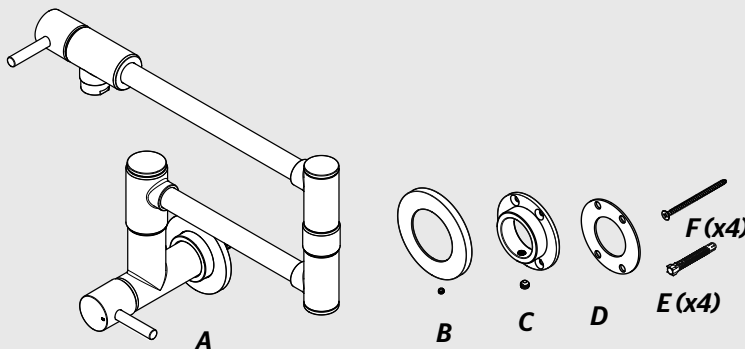

Hex Wrench
Llave hexagonal
Clé hexagonale

1 Turn Off Water Supply • Cierre el suministro de agua • Couper l'alimentation en eau



Locate water supply and shut off the water supply valve.

Localice el suministro de agua y cierre la válvula de suministro de agua.

Localisez l'approvisionnement en eau et fermez le robinet d'alimentation en eau.

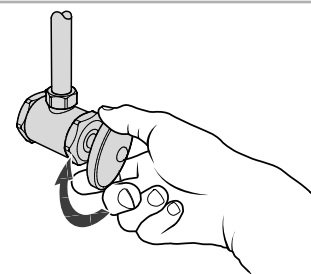

2

Mount Spout Holder

Una el soporte del grifo

Fixez le support robinet

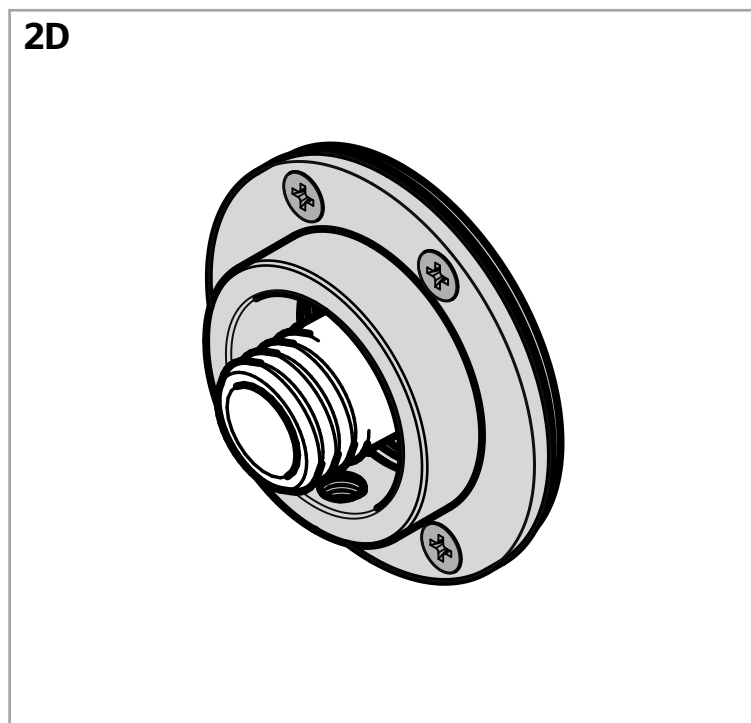
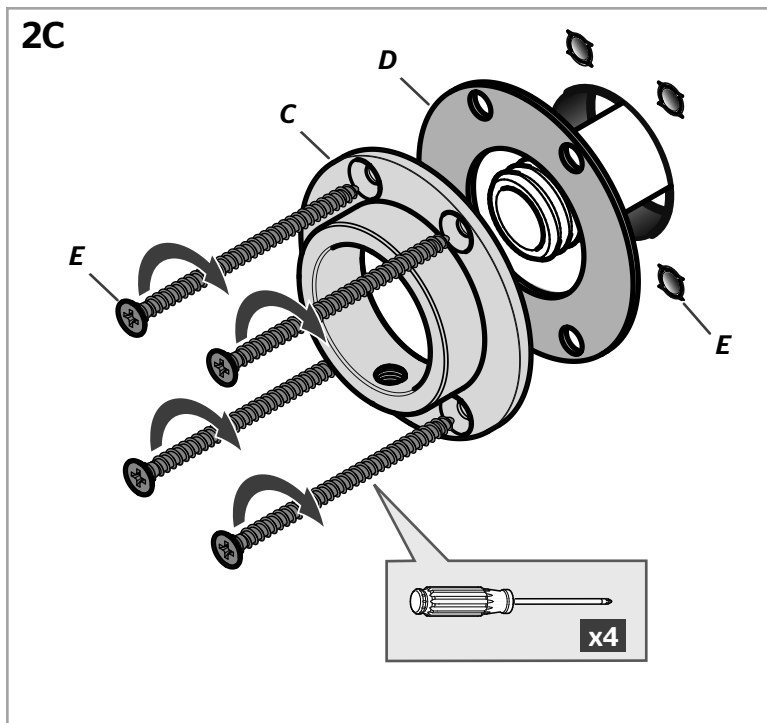
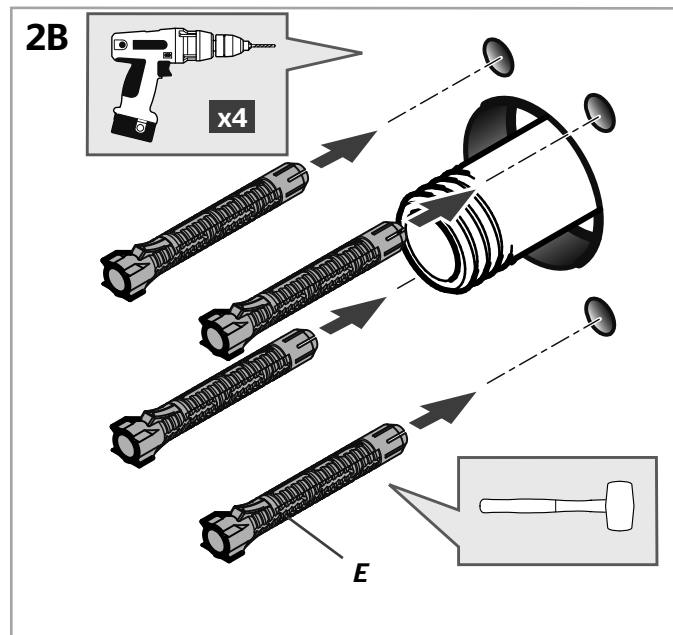
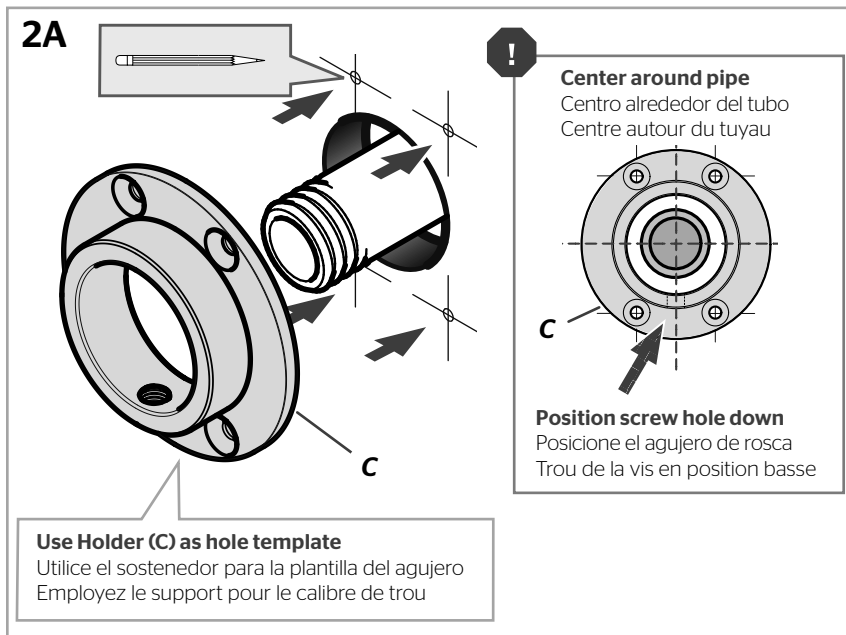
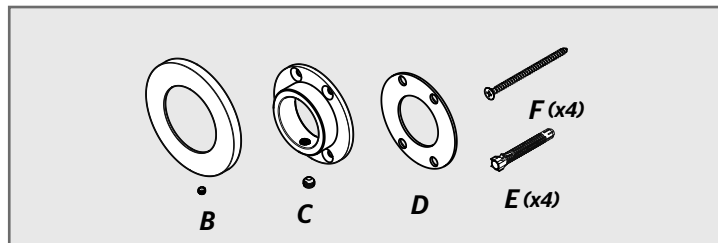
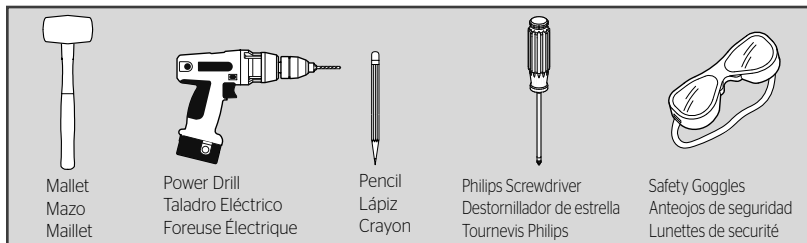

3

Attach Spout

Coloque el grifo

Fixez le robinet



PTFE plumber's tape
Cinta para plomería PTFE
Ruban PTFE de plombier

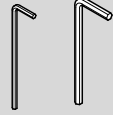

Hex Wrench
Llave hexagonal
Clé hexagonale

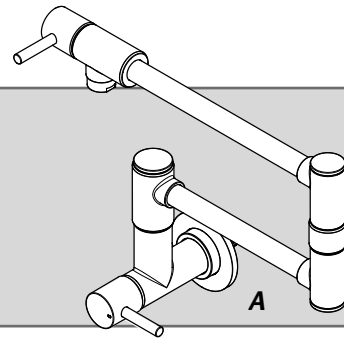

3A

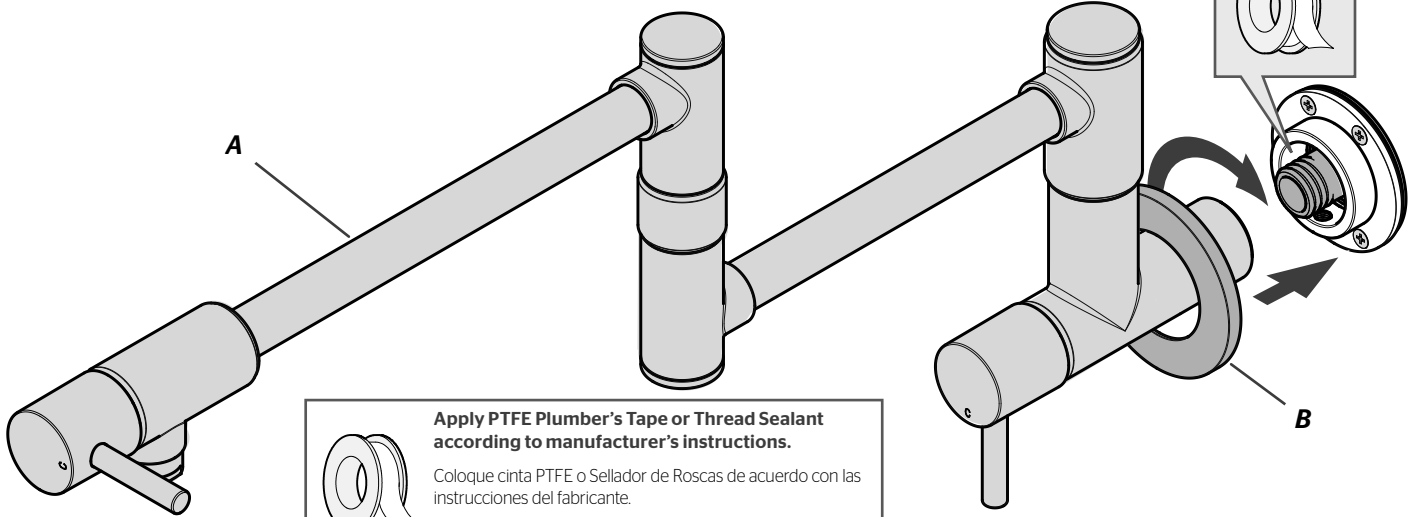

Apply PTFE Plumber's Tape or Thread Sealant according to manufacturer's instructions.

Coloque cinta PTFE o Sellador de Roscas de acuerdo con las instrucciones del fabricante.

Appliquez PTFE Plombiers bande ou le scellant de filets selon les instructions du fabricant.

3B

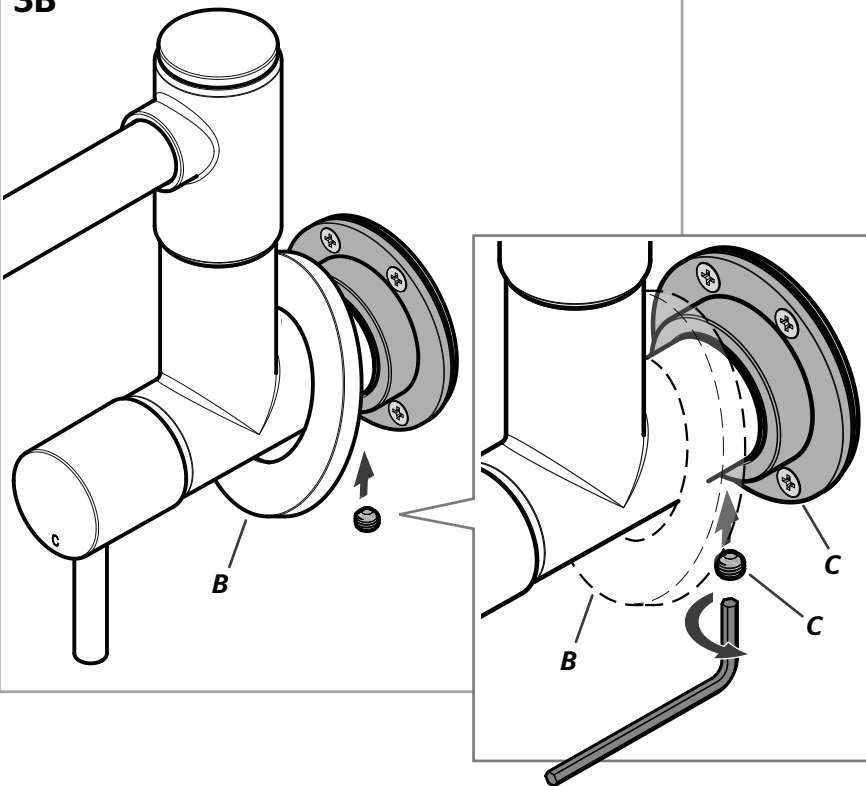

3C

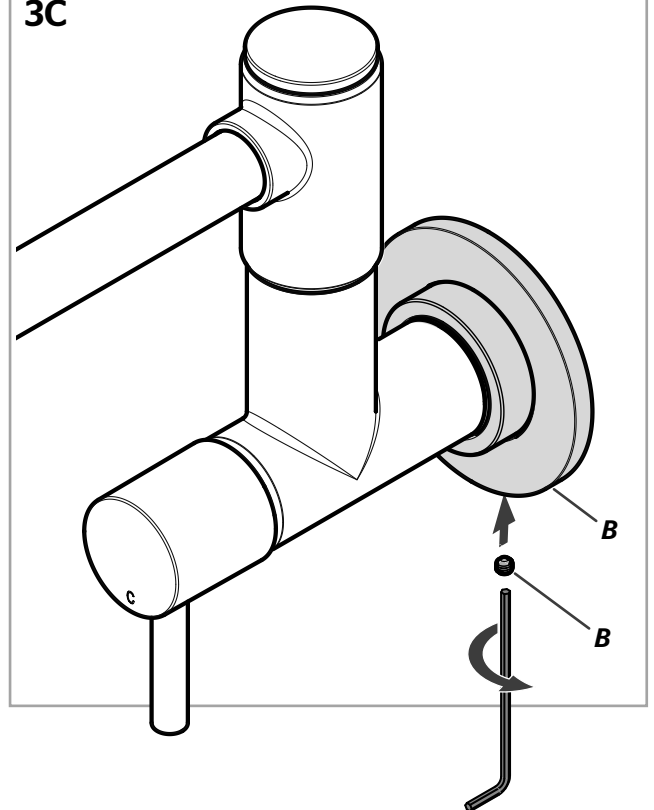

4**Turn On Water & Confirm Proper Installation****Active el suministro de agua y confirme que la instalación está adecuadamente efectuada****Ouvrez l'eau et confirmez que l'installation est correcte****Ensure both valves are in closed position.**

Asegúrese de que ambas válvulas están en posición cerrada.

S'assurer que les deux valves sont en position fermée.

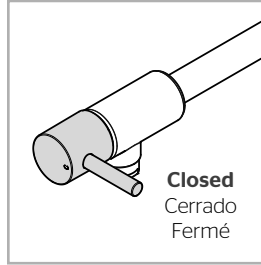
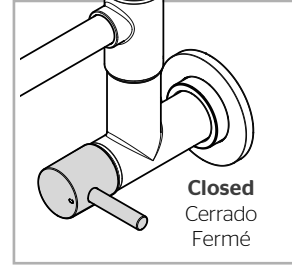
**Closed**
Cerrado
Fermé**Closed**
Cerrado
Fermé**Open main valve first.**

Abra la válvula principal de primera

Ouvrir le robinet principal d'abord

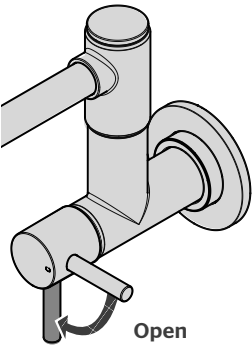
**Open**
Abierta
Ouvverte**Slowly open end valve.**

Abra lentamente

Ouvrez lentement

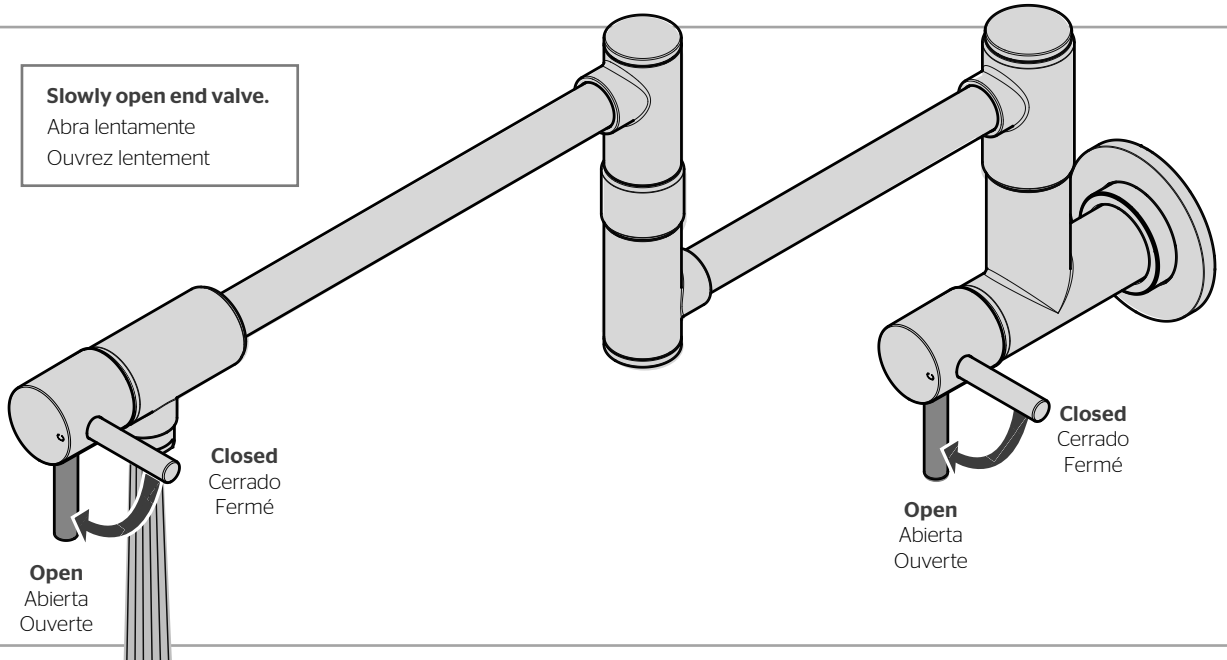
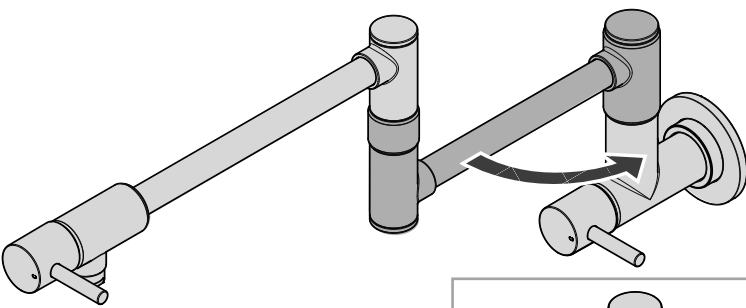
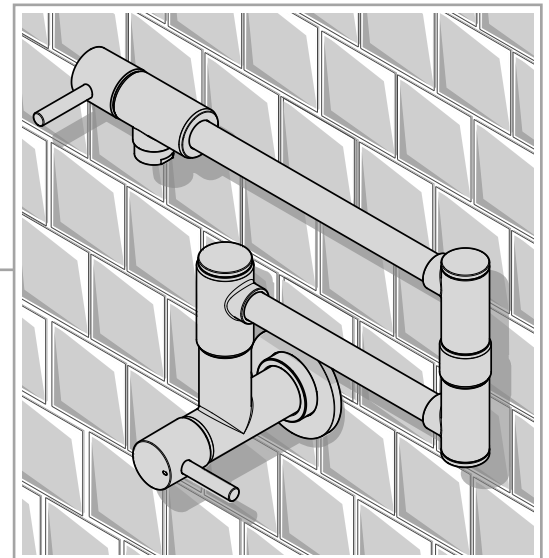
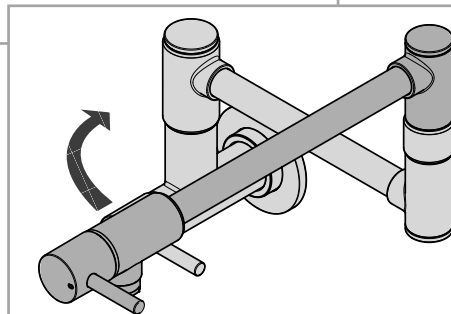
**Closed**
Cerrado
Fermé**Open**
Abierta
Ouvverte**Closed**
Cerrado
Fermé**Open**
Abierta
Ouvverte**Stowing Faucet**
Stowing Faucet
Rangement robinet**For Additional Installation Help:**

Para la instalación adicionales de ayuda:

Pour aider à l'installation supplémentaires:

Pfister**1-800-PFAUCET (732-8238)**
pfisterfaucets.com