

USE AND CARE GUIDE

DAWN LED WALLPACK

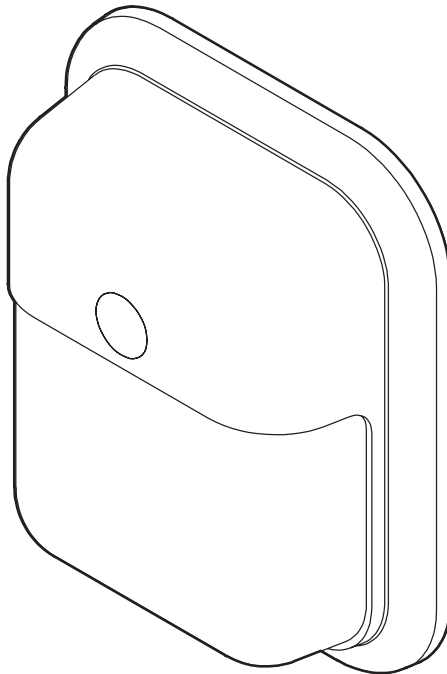

Questions, problems, missing parts? Before returning to the store,
call Commercial Electric Customer Service
9 a.m. - 5 p.m., EST, Monday - Friday

1-844-548-3776

HOMEDEPOT.COM

THANK YOU

We appreciate the trust and confidence you have placed in Commercial Electric through the purchase of this LED wallpack. We strive to continually create quality products designed to enhance your home. Visit us online to see our full line of products available for your home improvement needs. Thank you for choosing Commercial Electric!

Table of Contents

Safety Information	2	Installation	5
Warranty.....	2	Operation.....	8
Pre-Installation.....	3	Care and Cleaning	8
Preparing for Installation	5	Troubleshooting	9

Safety Information

IMPORTANT

THIS PRODUCT MUST BE INSTALLED IN ACCORDANCE WITH THE APPLICABLE NATIONAL ELECTRICAL CODE AND LOCAL BUILDING CODES BY A PERSON FAMILIAR WITH THE CONSTRUCTION AND OPERATION OF THE PRODUCT AND THE HAZARDS INVOLVED.

PRECAUTIONS

- Please read and understand this entire manual before attempting to assemble, install, or operate this light fixture.
- This light fixture requires a 120-Volt AC power source.
- Some codes require installation by a qualified electrician.
- This light fixture must be properly grounded.
- Make sure connections are secure using wire nuts, crimp-on lugs or other UL approved connecting devices.
- This light fixture should be installed outdoors to a wall.
- This product may contain chemicals known to be hazardous. Thoroughly wash hands after installing, handling, cleaning or otherwise touching the product.



WARNING: Before installation or servicing of the fixture, turn the power OFF at the circuit breaker or fuse. Place tape over the circuit breaker switch and verify power is OFF at the light fixture.



WARNING: Risk of fire. Keep the light fixtures at least 3 in. (76 mm) from combustible materials.



CAUTION: Burn hazard. Allow the light fixture to cool before touching.

NOTICE: Do not connect this fixture to a dimmer switch.

NOTICE: FCC Regulations state that any unauthorized changes or modifications to this equipment not expressly approved by the manufacturer could void the user's authorization to operate this equipment.



IMPORTANT: The device is tested and found to comply with Part 15 of the FCC Rules. Operation is subject to two conditions: (1) This device may not cause harmful interference and, (2) this device must accept any interference received, including any interference that may cause undesired operation.

This equipment has been tested and found to comply with the limits for a Class A digital device, pursuant to part 15 of the FCC rules. These limits are designed to provide reasonable protection against harmful interference when the equipment is operated in a commercial environment. The equipment generates, uses, and can radiate radio frequency energy and, if not installed and used in accordance with the instruction manual, may cause harmful interference to radio communications. Operation of the equipment in a residential area is likely to cause harmful interference in which case the user will be required to correct the interference at his own expense.

Warranty

This is a limited warranty offered by the manufacturer for a period of five years from the date of purchase to its customers. The manufacturer warrants to customers that the products will be free from defects in material and workmanship. The obligation of the manufacturer under this warranty is limited to the provision of replacement of products and is extended to the original purchaser of the product on presenting valid purchase receipt or other proof of date of original purchase acceptable to the manufacturer. The receipt is required for rendering the warranty performance. Any warranty claims without original proof of purchase would not be accepted.

It should be noted that the warranty does not apply to the manufacturer products that have been altered or repaired by unauthorized personnel, have been subjected to neglect, abuse, misuse or accident or damages caused during shipping. Any other products not manufactured by the manufacturer which have been supplied, installed and/or used in conjunction with the manufacturer products are not covered under this warranty. Any damages caused by replacements bulbs, LEDs or corrosion or discoloration of brass components are also not covered by this warranty.

Warranty (continued)

LIMITATION OF LIABILITY

In no event shall the manufacturer be liable for indirect, consequential, incidental or special damages, or lost profits. The manufacturer is not liable for any claims or damage arising out of or connected with the manufacture, sale, delivery, use, maintenance and repair or modification of the manufacturer products, or supply of any replacement parts that exceed the purchase price of the manufacturer products giving rise to a claim. Labor charges to remove or install the fixtures will not be accepted.

TO CLAIM

Please contact The Home Depot customer service at 1-844-548-3776 or email support@homedepot.com and include your name, address and contact number, along with a copy of the purchase receipt and a brief description of the problem.

Pre-Installation

PLANNING INSTALLATION

Before installing the light fixture, ensure that all parts are present. Compare parts with the Hardware Included and Package Contents sections. If any part is missing or damaged, do not attempt to assemble, install, or operate this light fixture.

Estimated installation time: 15 minutes

SPECIFICATIONS

Lumens (Light Output)	1000 Lumens
Watts (Power Consumption)	12 Watts LED
Replaces	75 Watt Incandescent Bulbs
Lumens/Watts (Efficacy)	83 Lumens per watt
Power Requirements (Input Voltage)	120VAC, 60 Hz
Light Color (CCT)	3000 Kelvins (Warm White)
Dimmable	Non-Dimming (Do not wire to dimming switch)
Operating Modes	Dusk-to-Dawn: Automatically turns light fixture ON during night and OFF during day. Switch-Controlled: Flip switch to turn light fixture ON and OFF. <i>Use included light sensor cover on fixture's light sensor to utilize this mode setting.</i>

TOOLS REQUIRED

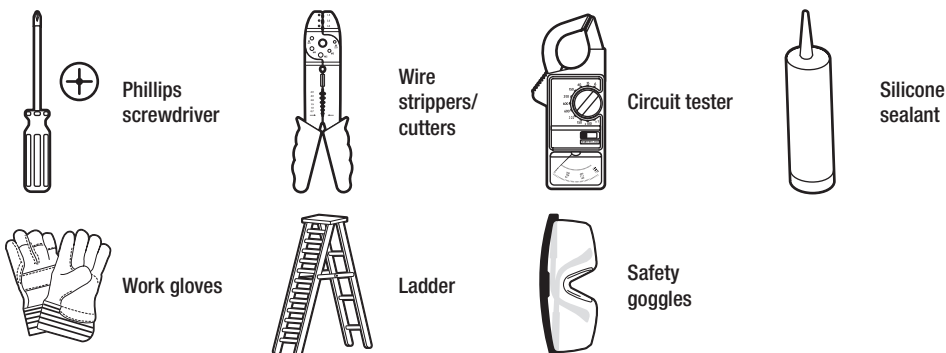

Pre-Installation (continued)

HARDWARE INCLUDED



NOTE: Hardware not shown to actual size.



AA



BB



CC

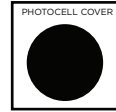

DD

Part	Description	Quantity
AA	#8-32x3/4 in. Phillips mounting bracket screw	2
BB	Wire nut	3
CC	Allen key	1
DD	Photocell black cover label	1

PACKAGE CONTENTS

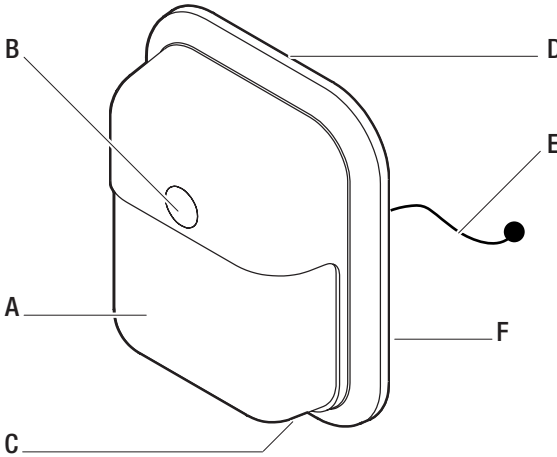

Part	Description	Quantity
A	Light fixture	1
B	Photocell (light sensor)	1
C	Mounting plate bolt (pre-installed)	1
D	Mounting plate with gasket (pre-installed)	1
E	Hanger wire for hands-free installation (pre-installed)	1
F	Leveling bubble	1

Preparing for Installation



CAUTION: Do not try to rotate the photocell receptacle on top of the fixture as it may twist the wiring.



NOTE: Make sure the photocell is locked on the receptor. Do not over rotate after it is locked.

Review this information to ensure a successful installation:

- Install the light 5–15 ft. above the ground.
- Do not mount the fixture close to reflective surfaces such as windows, white walls, white surfaces and water.
- When installing two fixtures on one switch, make sure the switch is rated for at least a 1A inductive load.
- Do NOT wire to a dimming switch.
- When mounting the fixture, make sure the photocell orientation is at the top for wall mount.
- When mounting to a wall, make sure the fixture is 7 in. on center away from the eave and 13 in. on center away from the inside corner of the exterior wall.



NOTE: The mounting plate (D) mounts to recessed mounted standard junction boxes. Junction box must be at least 1-1/2 in. in depth for proper installation for a recessed mount application.

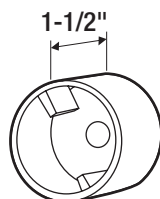
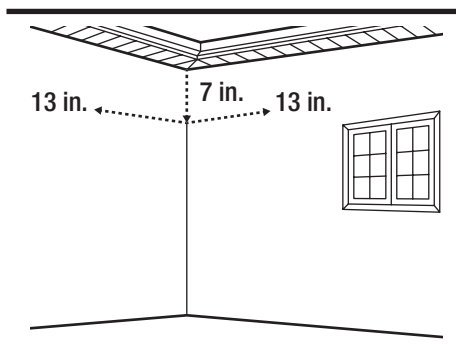
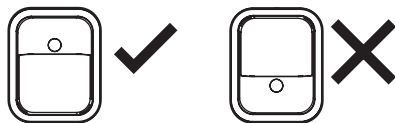
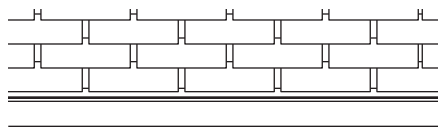

Round

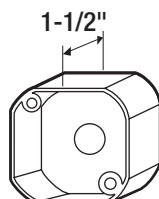

Octagonal/Square

Installation

1 Turning off the electricity

- Verify the wall switch is in the OFF position.
- Turn OFF power at the circuit breaker that supplies power to the outlet box you are working on.
- For screw-in type fuses unscrew the fuse that supplies power to the outlet box you are working on.

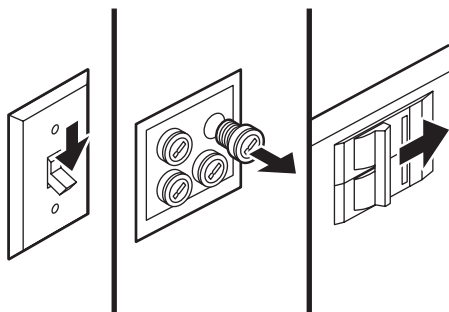

Installation (continued)

2 Removing the mounting plate



NOTE: The mounting plate (D) and mounting plate bolt (C) come pre-assembled on the light fixture (A) for shipping.

- Remove the mounting plate (D) from the back of the fixture by loosening the mounting plate bolt (C) using the Allen key (CC).



NOTE: Only unscrew the bolt (C) far enough to remove the mounting plate (D). Do not fully remove the bolt (C).

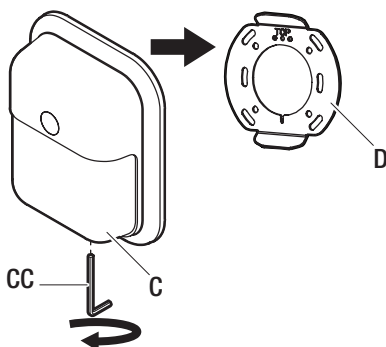

3 Installing the mounting plate

- Route the junction box wires through the large center hole in the mounting plate (D).
- Align the holes on the mounting plate (D) with the holes on your junction box. Use two #8 screws (AA), depending on the size of the holes in your junction box, attach the mounting plate (D) to your junction box.
- Please make sure, the “TOP” is upwards.
- Use the leveling bubble (F) on the mounting plate (D) to ensure the fixture is level.

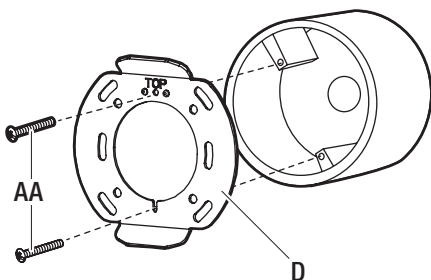

4 Hanging the fixture to the mounting plate

- Place the small sphere head of the hanger wire (E) between the back of the small groove located on the bottom of the center hole of the mounting plate (D).
- Ensure the photocell (B) is on the top part of the fixture (A) when installed.



NOTE: Ensure the light fixture (A) can safely hang onto the mounting plate (D) to allow for use of two hands to make the wiring connections.

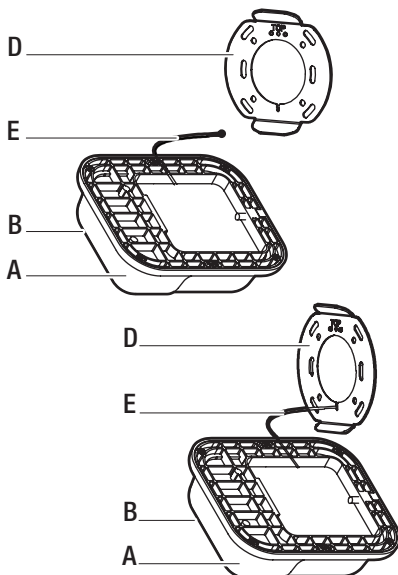

Installation (continued)

5 Making the electrical connections

- If necessary, strip 3/8 in. of insulation from the junction box or fixture (A) wires.
- Connect the fixture black wire to the supply black wire ((+) line), and fixture white wire to the supply white wire (-) common by twisting the exposed wires together and using the wire nuts (BB). Ensure there are no loose wires.
- Connect the supply ground wire to the green fixture ground wire by twisting the exposed wires together and using the wire nuts (BB).

NOTE: Hold stripped ends near each other and align any frayed strands (do not twist wires).

Push the wires into the wire nuts (BB) and use your fingers to twist the wire nut clockwise until tight. Check for tightness by pulling wires.

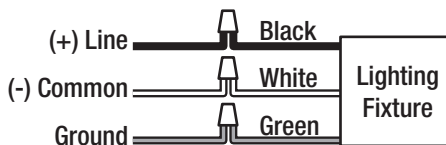
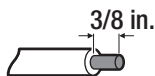
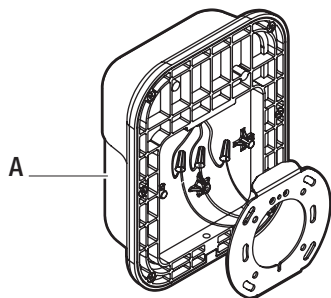

6 Mounting the light fixture

- Place the light fixture (A) onto the mounting plate (D) so the top-sloped groove on the plate rests on the top-sloped groove on the back of the fixture.
- Verify the fixture is flush with the wall and that the photocell (B) points upward for wall mount.
- Using the Allen key (CC), tighten the mounting plate bolt (C) back through the hole on the bottom of the fixture (A) until the bolt firmly pushes against the mounting plate (D).

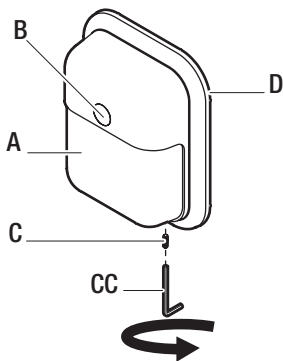

7 Caulking around the light fixture

- Caulk around the mounting plate (D) and surface with silicone sealant (not included).

NOTICE: Failure to properly caulk around the surface and mounting plate (D) could lead to water damage and is not covered under warranty.

NOTE: When attaching this fixture (A) to an external, surface mount junction box, caulk the inside of the light fixture before attaching to the mounting plate (D).

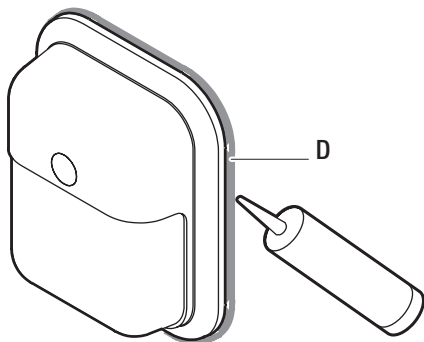

Operation

SELECTING DUSK-TO-DAWN OR SWITCH-ACTIVATED CONTROL

Option 1: Dusk-to-Dawn Operation

Dusk-to-dawn operation enables the light fixture to automatically turn ON when dark outside and turn OFF when the sun rises, thus saving you energy.

- To enable dusk-to-dawn operation remove temporary black cover label (DD) from the photocell (B) and confirm that it is unobstructed.
- Ensure the switch powering the outlet connected to the light fixture is turned to the ON position and leave it ON at all times to enable dusk-to-dawn functionality to operate automatically.

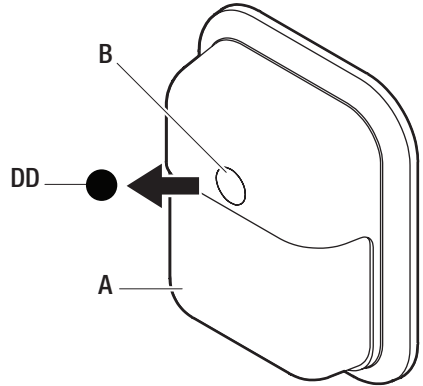

IMPORTANT: To test if the light fixture (A) and photocell (B) works properly run power to the fixture and cover the photocell with the cover label (DD) to turn the fixture ON. Shine a light into the photocell to see if fixture turns OFF.



NOTE: If the photocell (B) is located in an area under heavy shade the photocell may not detect enough light and may turn the light fixture on.

Option 2: Switch controlled

Switch controlled operation enables the light fixture to turn ON and OFF by flipping a switch that controls the electricity to the outlet powering the fixture. The light fixture will not turn ON and OFF automatically, but is manually controlled.

- To enable switch activated operation, put the photocell black cover label (DD) on the photocell (B) window.

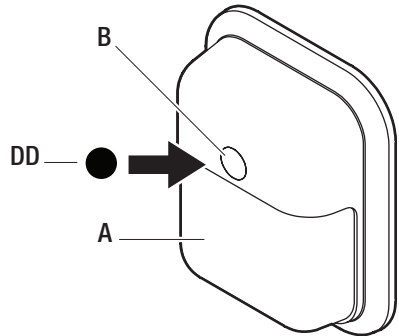

Care and Cleaning

- Shut off the main power supply before cleaning the product. To prolong the original appearance, clean the light fixture with clear water and a soft, damp cloth only.
- Do not use abrasive cleaners or cleaners that contain alcohol. Do not apply paints, solvents, or any other chemicals on this light fixture. They could cause a premature deterioration of the finish and may void the warranty.
- Do not spray the light fixture with a hose or power washer.

Troubleshooting

Problem	Possible Cause	Solution
The light does not turn ON.	There is no power to the fixture.	<ul style="list-style-type: none"> <input type="checkbox"/> Check if circuit breaker is tripped. <input type="checkbox"/> Confirm wall switch is ON. Verify wiring to the fixture is correct (turn power OFF to fixture beforehand).
	The fixture senses daylight.	Cover the photocell. Wait several seconds until the fixture turns ON.
The light cycles ON and OFF continuously.	The photocell light sensor is sensing reflected light.	<ul style="list-style-type: none"> <input type="checkbox"/> Relocate the light fixture to a location where there is no reflected light. <input type="checkbox"/> OR place the optional photocell cover over the photocell light sensor and use the wall switch to turn the light ON and OFF.
The light flickers.	The light fixture is wired through a dimmer switch.	Do not use a dimmer switch to control the light fixture. Replace the dimmer with a standard ON/OFF switch.
The light stays ON.	The light sensor is in a shaded area.	<ul style="list-style-type: none"> <input type="checkbox"/> Shine a flashlight into the light sensor and wait a couple minutes. If the light turns OFF, the fixture should be moved to a location with enough light in the daylight hours for the light sensor to work. <input type="checkbox"/> OR place the optional black cover label over the photocell light sensor and use the wall switch to turn the light ON and OFF.
	The light sensor is faulty.	If the light does not turn OFF when a flashlight is shined on the light sensor for up to a minute, then the sensor may be faulty. Please contact customer service.

 **NOTE:** The photocell (B) may have a short delay in order to reduce it's sensitivity to sudden light changes. When testing, shine a light/ cover the photocell for up to a minute to check if the fixture functions properly.



**Questions, problems, missing parts? Before returning to the store,
call Commercial Electric Customer Service
9 a.m. - 5 p.m., EST, Monday-Friday**

1-844-548-3776

HOMEDEPOT.COM

Retain this manual for future use.