



UKIAHI®

ELEVATED OUTDOOR LIVING PRODUCTS



LOOM I/II MANUAL

TK-1003-L | 7 2802848229 4
TK-1004-L2 | 7 2802848230 0

WWW.UKIAHCO.COM



IGNITE THE MUSIC™

WELCOME TO THE UKIAH Co. FAMILY

Based in the Pacific Northwest, Ukiah Co. was founded with a mission to offer the world products never before seen in the outdoor living market. Our goal is to offer affordable, top quality outdoor entertainment with unique and trend-setting styles that bring people together. Mankind has always been deeply connected to the outdoors, companionship and music; we develop products that embody these natural fundamentals of life. Wherever your adventures may find you, Ukiah Co. offers a diverse entertainment product line to enhance your outdoor experience at home or on the go. Our audio-capable products transform outdoor living spaces and enhance your favorite activities that will change the way you enjoy the outdoors.

CONGRATULATIONS ON YOUR LOOM PURCHASE

With our built-in patented sound system, this tabletop fire-pit becomes the entertainment centerpiece, day or night. Select "Music Only" mode and play your favorite music, podcast, or audio book. Efficient Li-ion battery ensures long operation times and flexibility of use whether on the deck, patio or in the backyard. The Loom II has the addition of our "Responsive Flame Technology" and multiple color options. Sit back and watch the flames dance in perfect harmony to your favorite music.

TABLE OF CONTENTS

PRODUCT DIAGRAMS // **PAGE 5**

GENERAL INFORMATION // **PAGE 6**

SAFETY INFORMATION // **PAGE 7**

LEAK TESTING // **PAGE 11**

LIGHTING SAFETY // **PAGE 12**

BEFORE USE // **PAGE 13**

SETUP INSTRUCTIONS // **PAGE 14**

LIGHTING INSTRUCTIONS // **PAGE 15**

AUDIO SYSTEM // **PAGE 16**

BEAT TO MUSIC MODE // **PAGE 17**

MAINTENANCE & STORAGE // **PAGE 18**

TROUBLE SHOOTING // **PAGE 19**

WARRANTY // **PAGE 20**

By purchasing this unit, you agree to follow all startup and safety instructions. You also agree that this product will not be used for any other reason as it was intended. Any questions or comments about our product, please click the "Contact us" link at www.UkiahCo.com

LOOM

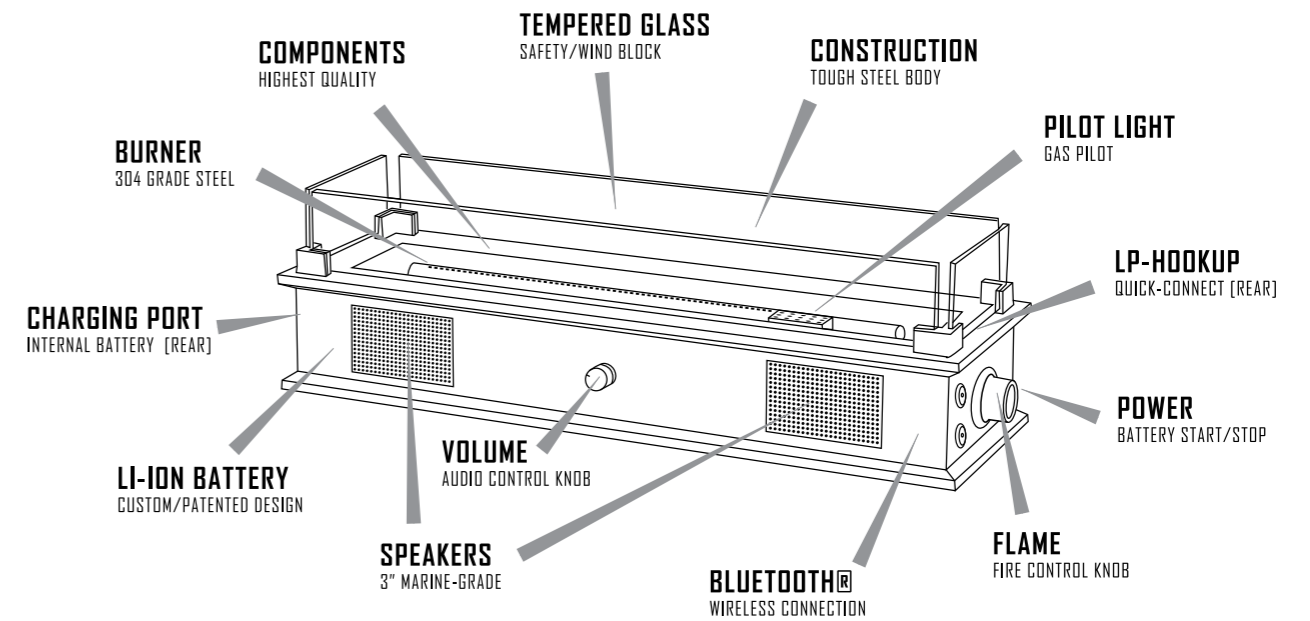

LOOM II

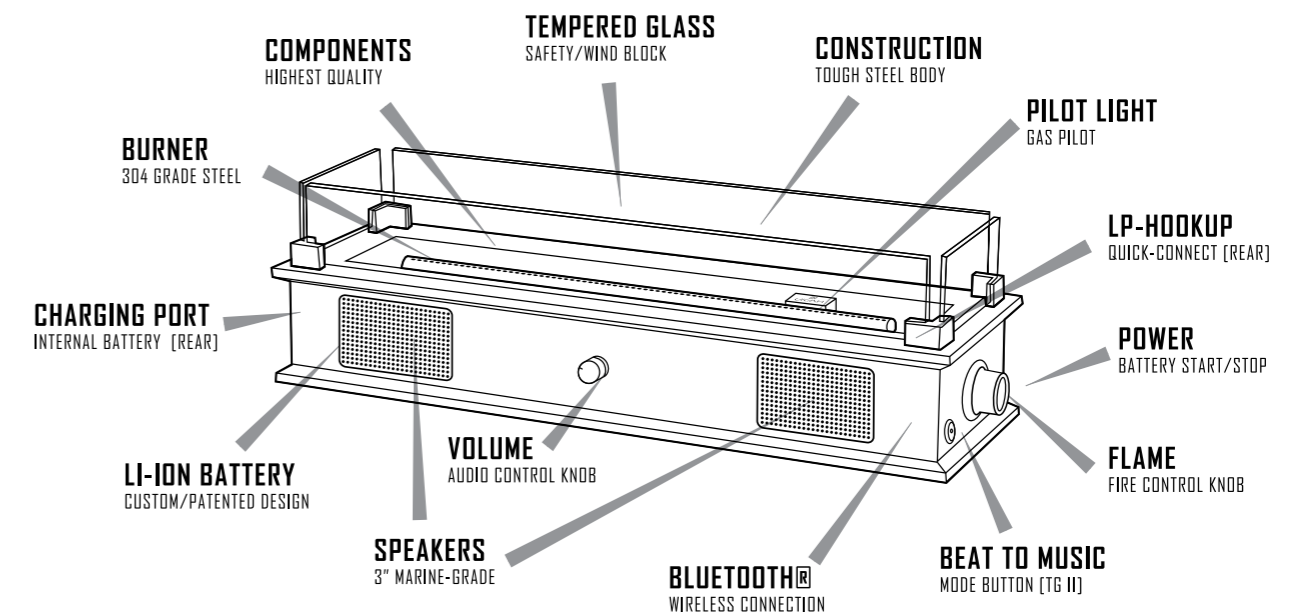

GENERAL INFORMATION

- This device can produce carbon monoxide that has no odor. Never use in an enclosed space of any kind, including but not limited to the inside of a home, garage or building. Use in such an enclosed space can be potentially fatal.
- Make certain that the outdoor area in which the product is being used offers acceptable cross ventilation.
- Gas cylinders must be stored outdoors in a well-ventilated area, out of the reach of children. Disconnected cylinders must have threaded valve plugs tightly installed and must not be stored in a building, garage or other enclosed area.
- Check with your local fire safety authority if you have any questions about the use or operation of portable gas cylinders or this gas fire pit.
- Operator should inspect the product before each use. It should be inspected at least annually by a qualified service technician. More frequent cleaning may be required as necessary. It is imperative that the control compartment, burner and circulation air passageways of the unit are kept clean and free of debris.
- If it is evident that there is excessive abrasion or wear on any of the components, they must be replaced prior to the product being put into service. Contact us at www.UkiahCo.com.
- The operator of this gas fire pit should alert adults and children to the hazards of high surface temperatures and the danger of burns or clothing ignition. Adults and children should maintain a reasonable distance from the open flame and hot surfaces. Flammable materials should not be placed near the fire pit.
- Flame heights can change suddenly. Never pass objects over the unit. Never place objects on top of the fire pit. Never reach over fire pit assuming the flame will remain at its "Low" setting.
- Always turn unit off after use.
- Young children should be closely supervised when near the product. Do not leave this gas fire pit unattended, especially around children or pets.
- Solid fuels such as wood, paper, or trash should not be burned in this gas fire pit. This product is designed for decorative purposes only, and should not be used for heating, cooking, or drying.
- Do not attempt to assemble or operate this fire pit while under the influence of any type of alcohol or medication. Use this gas fire pit in accordance with all applicable local, state, and national codes.
- Any guard or protective device removed in order to service the device must be replaced prior to operating the fire pit.
- Inspect the fuel supply for evidence of leakage prior to each use of the fire pit. The pressure regulator and hose assembly supplied must always be used.
- The 20 lb. gas cylinder must be constructed and marked in accordance with the specifications for Liquid Propane-Gas cylinders as required by the U.S. Department of Transportation (DOT) or the Canadian Transportation Commission (CTC).
- The 20 lb. gas cylinder used must include a collar to protect the cylinder valve.
- When the unit is not in use, the gas supply must be turned completely off using the valve on the cylinder tank.

SAFETY INFORMATION

WARNING

Please read these setup and operating instructions carefully before setup, operation or service of this gas fire pit. Do not operate if you are uncertain as to the meaning of any instructions or warnings. Improper installation, adjustment, alteration, maintenance, service or use of this product may result in property damage, personal injury or the potential loss of life.

Save these instructions for future reference. If you are assembling this unit for another person, give this manual to the fire pit operator to read and save for future reference. If ownership of the product is transferred, this manual should be provided to the new owner.

This product is designed to use Liquid Propane fuel only. Do not attempt to use natural gas as a fuel. **ONLY OUR HOSE AND REGULATOR SUPPLIED IN THE PACKAGING CAN BE USED WITH OUR FIRE PITS.**

Failure to follow the DANGERS, WARNINGS, AND CAUTIONS in this owner's manual may result in serious bodily injury, death, or may result in a fire or an explosion causing damage to property.

 **WARNING:** This product is for outdoor use only.

 **WARNING:** Do not use this product near vegetation or on, under, or near structures that could catch fire such as wooden decks, vinyl siding, or porches with overhangs.

 **WARNING:** This product produces high temperatures that will create hot surfaces. Appropriate care should be used to avoid physical contact with these surfaces.

 **WARNING:** Do not use this product during windy conditions.

 **WARNING:** This product should be used on a flat and stable surface to avoid overturning.

 **WARNING:** Do not leave unattended when in use or connected to a fuel supply.

 **WARNING:** This product includes small components such as glass crystals that may pose a choking hazard or cause significant physical injury if swallowed. Appropriate care must be taken to prevent children from having unsupervised access to this product or any of its components.

 **WARNING:** Maintenance or service on this product must be performed by a qualified installer or licensed service professional.

 **WARNING:** DO NOT move the unit for at least 60 minutes after use to allow for cooling.

 **WARNING:** Allow the burner and glass crystals or lava rock to cool completely before touching.

 **WARNING:** Glass crystals or Lava rock may be sharp. Before handling, make certain they have cooled completely and handle them wearing protective gloves to prevent injury.

 **WARNING:** This device can produce carbon monoxide that has no odor. Never use in an enclosed space of any kind, including but not limited to the inside of a home, garage or building. Use in such an enclosed space can be potentially fatal.

 **WARNING:** After a period of storage or non-use, check for leaks and burner obstructions.

 **WARNING:** Do NOT attempt to disconnect the gas regulator from the cylinder or any gas fitting while the fire pit is in use.

⚠ WARNING: Do NOT attempt to move fire pit when in use.

⚠ WARNING: Always keep children and pets away from fire pit.

⚠ WARNING: Never lean over the fire pit when lighting or in use.

⚠ WARNING: Do NOT attempt to repair or alter the pressure regulator for any assumed defect. Any modification to this assembly will void your warranty and create the risk of a gas leak and fire.

⚠ WARNING: This fire pit should be thoroughly cleaned and inspected on a regular basis.

⚠ WARNING: Do NOT use the fire pit unless it is COMPLETELY assembled, and all parts are securely fastened and tightened.

⚠ WARNING: Do NOT use in an explosive atmosphere.

⚠ WARNING: Do NOT store or use gasoline or other flammable liquids or vapors within 25 feet (7.62 m) of this appliance.

⚠ WARNING: Recheck all connections as described in the "Operating Instructions" section of this manual, as shipping can loosen connections.

- Check for leaks even if your unit was assembled for you by someone else.
- Do NOT operate if a gas leak is present. Gas leaks may cause a fire or explosion.
- You must follow all instructions in the "Checking for Leaks" section before operating.

⚠ WARNING: To prevent a fire or explosion hazard when testing for a leak:

- Always perform a leak test before lighting the fire pit and each time the cylinder is connected for use.
- No smoking. Do NOT use or permit sources of ignition in the area while conducting a leak test.
- Conduct the leak test outdoors in a well-ventilated area.
- Do NOT use matches, lighters, or a flame to check for leaks.
- The use of alcohol, prescription or non-prescription drugs may impair the consumer's ability to properly assemble or safely operate the appliance.
- Strong odors, colds, sinus congestion, etc. may prevent the detection of propane. Use caution and common sense when testing for leaks.
- Do NOT use fire pit until any and all leaks are corrected. If you are unable to stop a leak, disconnect the LP gas supply. Call a gas appliance serviceman or your local LP gas supplier.

⚠ WARNING: Never keep an LP gas cylinder in a hot car or trunk. Heat will cause the gas pressure to increase, which may open the relief valve and allow gas to escape.

⚠ WARNING: Do NOT block holes in sides or bottom of fire pit.

⚠ WARNING: Apartment dwellers: Check with management to learn the requirements and fire codes for using a LP gas fire pits in your apartment complex.

⚠ WARNING: This fire pit is not intended for and should never be used as a heater. TOXIC fumes can accumulate and cause asphyxiation.

⚠ WARNING: ELECTRONICS INSIDE, MUST PUT COVER ON UNIT WHEN LEAVING OUT IN WET CONDITIONS.

⚠ DANGER: Do not use the product if any part has been submerged in water. Immediately call a qualified service technician to inspect the unit and to replace any part of the control system and any gas control that has been in water.

⚠ WARNING: Special care must be taken to keep children and pets away from hot surfaces.

⚠ WARNING: Deaths, serious injury or damage to property may occur if the above is not followed exactly.

⚠ DANGER - If you smell gas fumes:

1. Shut off gas to the appliance by turning the fuel knob to "OFF" and turn LP tank off.
2. Extinguish any open flame. Do not touch or make contact with any electrical switches.
3. Do not ignite a match or lighter of any kind.
4. Do not use any phone, including cell phones, in the vicinity of the gas source.
5. If the smell of fumes persists, call the local fire department from a remote phone.

Failure to follow these instructions could result in fire or explosion which could cause property damage, personal injury, or death.

⚠ WARNING

- Do not store or use gasoline or other flammable liquids or vapors in the vicinity of this or any other appliance.
- An LP cylinder not connected for use should not be stored near this or any other appliance.
- If a fire should occur, keep away from the appliance and immediately call your fire department.

Failure to follow these instructions could result in fire, explosion or burn hazard, which could cause property damage, personal injury or death.

The LP gas tank is NOT included with the gas fire pit.

SAFE HANDLING FOR LP GAS TANK:

- Do not use a damaged, dented or rusty LP tank.
- Handle empty LP tanks with the same care as you handle full tanks. Even when the LP tank is empty of liquid, there may still be gas pressure inside the cylinder.
- LP gas tanks should never be dropped or handled roughly.
- Never store or transport the LP tank where temperatures can reach 125 °F (51.7 °C).
- LP tanks must be kept out of reach of children.

⚠ WARNING

- DO NOT block any ventilation openings.
- Install in accordance with the manufacturer's instructions.
- DO NOT defeat the safety purpose of the polarized or grounding-type plug. A polarized plug has two blades with one wider than the other. A grounding type plug has two blades and a third grounding prong. The wider blade or the third prong are provided for your safety. If the provided plug does not fit into your outlet, consult an electrician for replacement of the obsolete outlet.
- PROTECT the power cord from being walked on or pinched particularly at plugs, convenience receptacles, and the point where they exit from the apparatus.
- ONLY USE attachments and accessories specified by the manufacturer.
- UNPLUG this apparatus during lightning storms or when unused for long periods of time.
- REFER all servicing to qualified service personnel. Servicing is required when the apparatus has been damaged in any way, such as power-supply cord or plug is damaged, liquid has been spilled or objects have fallen into the apparatus.
- DO NOT overload wall outlets or extension cords beyond their rated capacity as this can cause electric shock or fire.
- Danger of explosion if battery is incorrectly replaced. Replace only with the same or equivalent type.
- DO NOT ingest the battery.
- Keep new and used batteries away from children.

⚠ WARNING

- If the battery compartment does not close securely, stop using the product and keep it away from children.
- If you think batteries might have been swallowed or placed inside any part of the body, seek immediate medical attention.
- The battery (battery, batteries or battery pack) shall not be exposed to excessive heat such as sunshine, fire or the like.
- DO NOT handle leaking or damaged batteries.
- Only use the specified type of Batteries.
- Observe correct polarity.
- Remove batteries from products that are not in use for extended periods of time. Store batteries in a dry place.
- Do not recharge non-rechargeable batteries.
- Avoid exposure to extreme heat or cold.
- THIS PRODUCT CONTAINS A CELL BATTERY. IF MISUSED OR ABUSED THIS CAN RESULT IN:
-Smoke or gas hazard -Heat hazard -Fire hazard -Explosion hazard

⚠ WARNING

Keep out of reach of children. The content of this package includes small parts and cords that can cause choking or strangulation.

⚠ WARNING

Fuels used in gas or oil-fired appliances, and the products of combustion of such fuels, contain chemicals known to the State of California to cause cancer, birth defects or other reproductive harm. This warning is issued pursuant to California Health and Safety Code Sec. 25249.6.

PROPOSITION 65 WARNING

Handling the brass material on this product exposes you to lead, a chemical known to the state of California to cause cancer, birth defects or other reproductive harm. WASH YOUR HANDS AFTER HANDLING THIS PRODUCT.

LEAK TESTING

LEAK TESTING:

All factory-made connections have been thoroughly tested for gas leaks. However, shipping and handling may have loosened a gas fitting.

AS A SAFETY PRECAUTION:

- TEST ALL FITTINGS FOR LEAKS BEFORE USING YOUR GAS FIRE PIT.
- TEST THE CYLINDER VALVE FOR LEAKS EACH TIME THE CYLINDER IS FILLED.
- TEST FOR LEAKS EVERY TIME YOU CONNECT A GAS FITTING.
- DO NOT SMOKE WHILE TESTING FOR LEAKS.
- NEVER TEST FOR LEAKS WITH A LIGHTED MATCH OR OPEN FLAME.
- TEST FOR LEAKS OUTDOORS.

⚠ DANGER: Do NOT use an open flame to check for gas leaks. Be sure there are no sparks or open flames in the area while you check for leaks. Sparks or open flames will result in a fire or explosion, which could result in serious bodily injury or death and damage to property.

⚠ WARNING: To prevent a fire or explosion hazard when testing for a leak:

- Always perform a leak test before lighting the fire pit and each time the cylinder is connected for use.
- No smoking. Do NOT use or permit sources of ignition in the area while conducting a leak test.
- Conduct the leak test outdoors in a well-ventilated area.
- Do NOT use matches, lighters, or a flame to check for leaks.
- The use of alcohol, prescription or non-prescription drugs may impair the consumer's ability to properly assemble or safely operate the appliance.
- Strong odors, colds, sinus congestion, etc. may prevent the detection of propane. Use caution and common sense when testing for leaks.
- Do NOT use grill until any and all leaks are corrected. If you are unable to stop a leak, disconnect the LP gas supply.

Call a gas appliance serviceman or your local LP gas supplier.

TO TEST FOR LEAKS:

1. Extinguish any open flame or cigarettes in the area.
2. Check the cylinder valve and appliance valves are in the "OFF" position.
3. Connect LP gas cylinder.
4. Prepare a soap solution of one-part water, one-part liquid detergent.
5. With a full gas cylinder, open cylinder slowly.
6. Brush the soap solution on each connection and along the hose.
7. A leak is identified by a flow of bubbles from the area of the leak.
8. If a leak is detected, close the gas cylinder "shut-off" valve, tighten the connection and retest (Step 5)
9. If the leak persists, do not attempt to operate appliance and contact Ukiah Co.

LIGHTING SAFETY

FOR YOUR SAFETY, READ BEFORE LIGHTING

- Make sure you are familiar with the owner's manual and you understand all precautions noted.
- Before operating, smell around the appliance and next to the ground for gas odors because some gases are heavier than air and may settle on the ground.
- Use only your hand to turn the gas control valve. Never use tools. If the valve will not turn (that is, without the use of a tool), do not try to repair it. Call a qualified service technician.
- Do not use the appliance if any part has been submerged in water. Immediately call a qualified service technician to inspect the unit and to replace any part of the control system and any gas control that has been under water.
- Make sure the igniter batteries have been installed properly. The igniter will not operate otherwise.
- Inspect hoses to make sure there are no kinks in them and check for leaks.
- After connecting the gas line and checking for leaks, the unit is ready to be lit. Upon the initial use, a small amount of air will be in the lines. When first lighting the burner, it will take a few seconds for the lines to purge themselves of this air.
- Once purging is complete, the burner will light and operate as indicated in the instruction manual. Subsequent lighting of the unit will not require purging unless the gas supply has been disconnected.

⚠ WARNING: Read and follow the safety and lighting instructions in this manual and on the labels on the appliance. IMPROPER SETUP OR USE COULD RESULT IN A FIRE OR EXPLOSION RESULTING IN PROPERTY DAMAGE, INJURY OR LOSS OF LIFE.

OPERATIONAL NOTES

1. DO NOT move the unit for at least 60 minutes after use to allow for cooling.
2. Allow the burner and glass crystals or lava rock to cool completely before touching.
3. Glass crystals or lava rock may be sharp. Before handling, make certain they have cooled completely and handle them wearing protective gloves to prevent injury.

BEFORE USE

IGNITION BATTERY

1. Install one AA battery for the electronic ignition located inside of the unit (battery not included). Unscrew igniter cap counterclockwise, insert battery with positive side facing out, then tighten igniter cap back on (make sure the battery is installed the proper direction). [Figure 1]

CHARGING THE AUDIO BATTERY

1. Before using your Ukiah Co. audio system, fully charge the battery by plugging the charging cable provided into the charging port on the unit. [Figure 2]

- The LED INDICATOR on the charger will turn RED when the battery is charging.
- The LED INDICATOR will turn GREEN when the battery is fully charged.

The battery will run for up to 20 hours on a single charge. The unit can be operated while connected to the charger. The internal battery powers the audio system only and is not needed for "Fire Only" mode.

⚠ WARNING – Charge the battery by using only the original charging cable supplied. Using another charging cable may harm the battery.

LAVA ROCK/GLASS MEDIA

1. Open the bag containing the decorative glass or lava rock and carefully place in the burner tray, making sure not to cover the screen that protects the ignition system or the holes of the burner. If the burner holes are covered, the flames will not react to music and sound as intended. Replace magnetic lid if applicable to keep media contained for transportation.

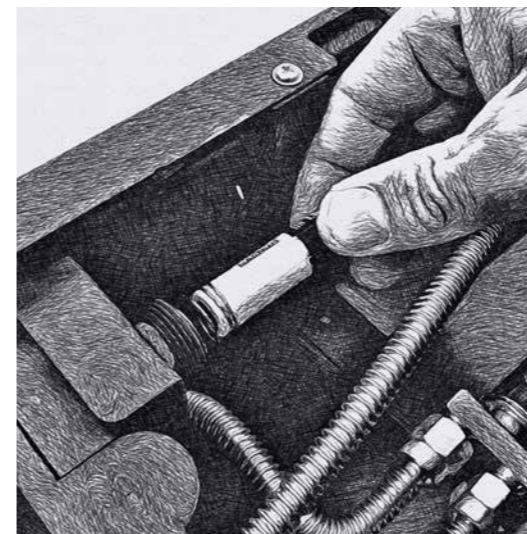

[Figure 1] - Install one AA battery.

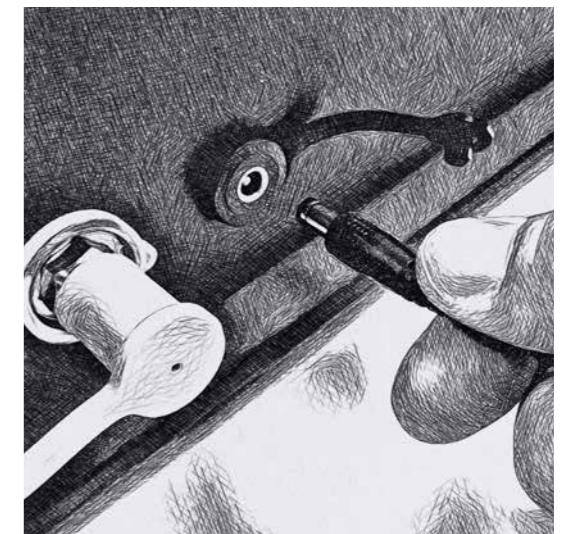

[Figure 2] - Battery charger input.

SETUP INSTRUCTIONS

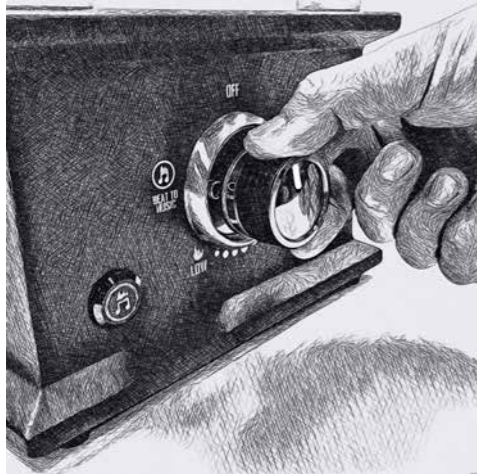

[Figure 3] - Turn gas control to "OFF".

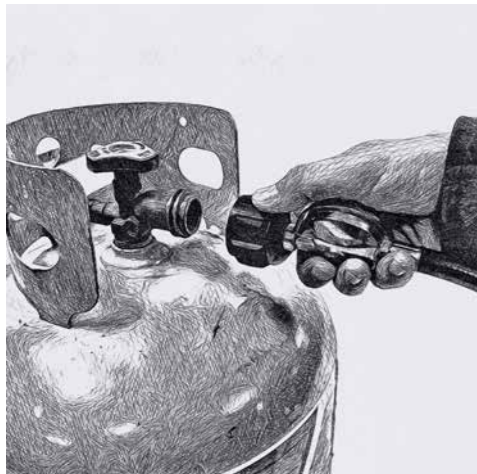

[Figure 4] - Connect supplied regulator and do not over-tighten.

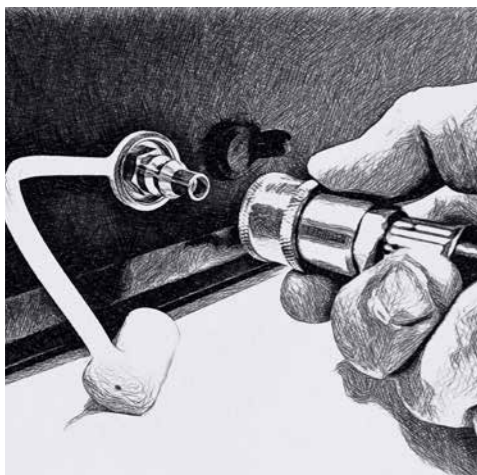

[Figure 5] - Attach quick-connect end of regulator to the unit.

REGULATOR CONNECTIONS:

Your Ukiah Co gas fire pit is equipped with a specialized pressure regulator, which is a device to control and maintain uniform gas pressure as gas is released from the LP cylinder. This pressure regulator is designed for vapor withdrawal.

⚠ WARNING: Use only the original specially designed regulator supplied with your unit. Using another regulator may be dangerous.

⚠ WARNING: Use tanks that are marked "Propane Fuel" only.

⚠ WARNING: Read carefully all instructions contained on the information plate attached to the fire pit.

⚠ WARNING: Do not transport your fire pit with LP Tank connected.

1. Place the fire pit in the desired location. Make sure that it is placed outdoors in a well-ventilated area away from any flammable structures, awnings, vegetation, etc.

2. Place your 20lb LP tank in a location that is not in a walkway or where it can be easily knocked over. Maintain 60 inches between the unit and tank. For safest operation use a commonly-available LP tank holder.

3. Make sure the unit gas control knob is turned to "OFF" by pushing it in and turning it clockwise to the off position. [Figure 3]

4. Make sure the propane cylinder valve is turned off by turning valve clockwise.

5. While holding carrying handle closest to propane cylinder, connect regulator to propane cylinder and turn clockwise until snug (DO NOT OVER-TIGHTEN). Use only supplied regulator included with your unit. [Figure 4]

6. Attach quick-connect on opposite end of regulator hose to your unit. [Figure 5]

⚠ WARNING: Do not over-tighten or use a wrench to tighten the regulator connection. Over-tightening could damage the regulator coupling and cause a leak.

LP TANK REMOVAL:

When the LP tank needs to be replaced, follow these instructions to remove it.

1. Make sure gas control knob is turned "OFF" by pushing it in and turning it clockwise to the off position.

2. While holding carrying handle closest to propane cylinder with one hand, unscrew propane cylinder from regulator.

LIGHTING INSTRUCTIONS

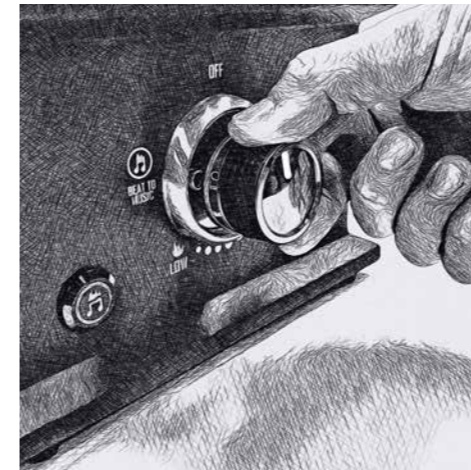

[Figure 6] - Turn gas control to "OFF".

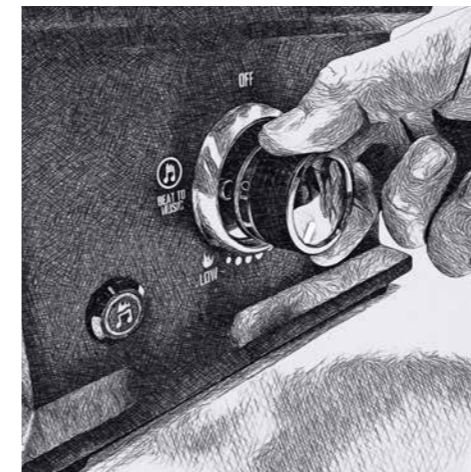

[Figure 7] - Press, hold and turn to low.

⚠ WARNING: Before lighting, remove weather cover and remove lid when applicable.

⚠ WARNING: DO NOT stand with your head or arms over the fire pit at any time.

1. Make sure control gas knob on unit is set to "OFF", then turn on the gas supply. Open the tank valve fully by slowly turning the handle counterclockwise. [Figure 6] Purge the gas supply line of any trapped air and check for leaks prior to the first lighting of the unit. See "Lighting Safety" section for details.

2. To ignite, push and hold gas control knob on unit for 3 - 5 seconds while turning to "LOW" and once ignited continuing to depress the fuel control knob for an additional 5-10 seconds before releasing. The flame should stay lit. This will actuate the thermal coupler. [Figure 7]

NOTE: The built in thermocouple safety device needs to warm up to engage, ensuring the gas will be shut off in the event of the unit being tipped over or blown out.

3. If igniter does not light burner, replace battery or use a long match or long butane lighter.

4. Adjust flame to desired level with the fuel control knob on the unit.

5. After operation, turn all gas knobs to the "OFF" position and push the ON/OFF switch to off. Remember to turn the valve on top of the gas cylinder to the "OFF" position.

IF BURNER DOES NOT IGNITE:

If ignition is not immediate, push and turn the control knob clockwise to "OFF". The gas supply will automatically shut off after approximately 10 seconds (+/- 3 seconds) if a flame does not start or it is extinguished. If this happens, wait 5 minutes for gas fumes to clear and re-try or refer to the troubleshooting section if the unit does not re-start. If problem cannot be resolved, do not attempt to operate the appliance; contact your dealer or approved service center.

AUDIO SYSTEM

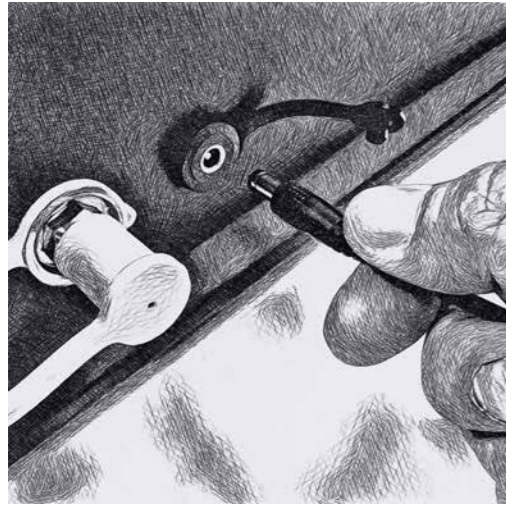

[Figure 8] - Audio battery charging port.

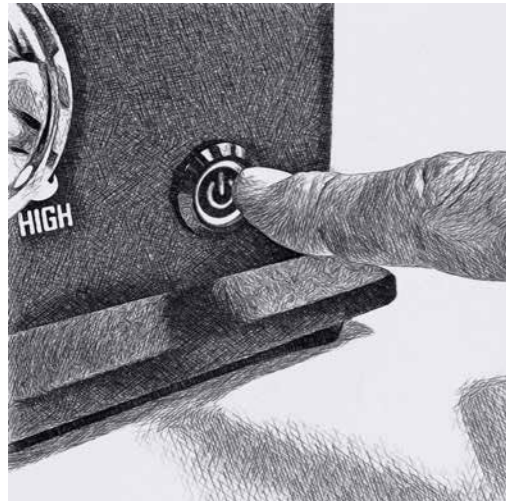

[Figure 9] - Audio system power button.



[Figure 10] - Audio volume control knob.

CHARGING THE BATTERY

Before using your Ukiah Co. audio system, follow steps on page 13 to fully charge the battery.

PAIRING TO A Bluetooth® DEVICE

1. Turn your Bluetooth® device OFF entirely and then turn it back ON to refresh the device's Bluetooth® memory.

2. Find the Bluetooth® menu in your device and make sure the Bluetooth® function is turned ON (refer to your device's user manual for instructions on finding the Bluetooth® menu).

3. Turn your Ukiah Co. product ON using the ON / OFF SWITCH. The audio system will say "waiting for connection". [Figure 9]

4. On your device, perform a Bluetooth® "device discovery" to add "UKIAH" as a new device.

5. When the speaker is discovered your device will display "UKIAH" in the Bluetooth® menu.

6. When your device is connected, the audio system will say "connected".

• NOTE: Keep the Bluetooth® function on your device ON, to ensure the speaker can automatically pair with your device the next time the audio system is turned ON.

PLAYING MUSIC

After successfully pairing the unit with your Bluetooth® device, you can begin playing music or any audio through your device's menu system (refer to your device user manual for instruction on playing music).

ADJUSTING THE VOLUME

The speaker volume can be adjusted by turning the volume control knob located on the front of the unit, or directly on your Bluetooth® device. [Figure 10]

⚠ WARNING: Playing music at high volumes can damage hearing.

USING THE SPEAKER FOR HANDS-FREE PHONE CALLS

Once your smart-phone has successfully paired with your Ukiah Co. product, you can use the speaker and built-in microphone for hands-free calls.

NOTE: The MIC is located on the front of the unit just below the volume knob. For best call quality remain near the product.

BEAT TO MUSIC OPERATION

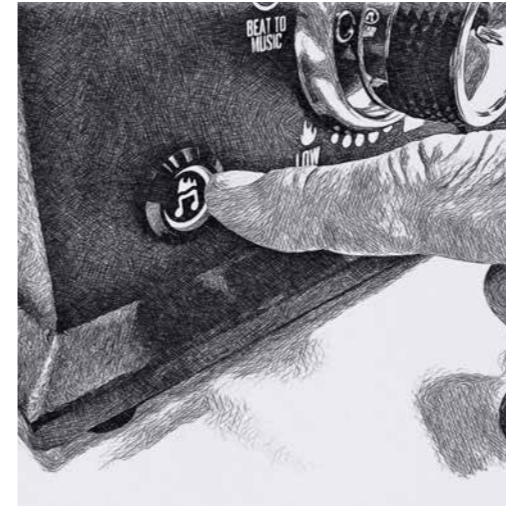

[Figure 11] - Beat to Music power button.

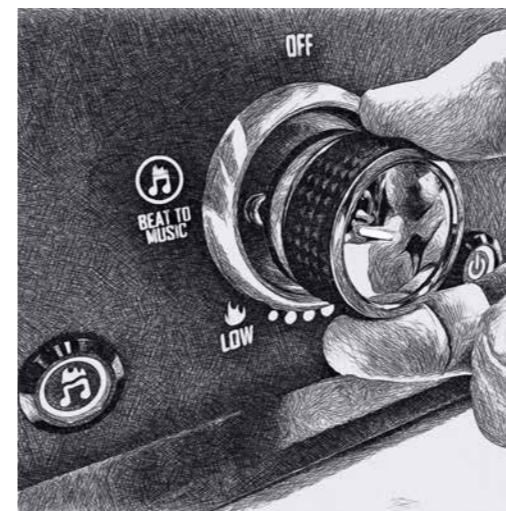

[Figure 12] - Beat to Music (BTM) fuel knob setting.

Follow the below steps to start "Beat to Music" mode, available in select models, after setup and lighting in "Fire Only" mode (page 14-15).

AFTER FIRE PIT IS LIT:

⚠ WARNING: Sudden flame height and regular intensity changes occur when "Beat to Music" mode is engaged. Once audio device is connected, stay clear of burner area before playing audio clip.

1. Push the "Beat to Music" button. Button will glow orange when ON. [Figure 4]

2. Turn gas control knob to the "Beat to Music" icon. When the two icons are matched, "Beat to Music" mode will be engaged and the flame will drop down to a lower height. [Figure 5]

3. After Bluetooth® connection is made (page 16), stand clear of fire pit and play your audio. Observe the fire reacting to the sound.

4. Control the sensitivity of the fire show by turning the volume up or down on your phone or media device being used.

* Higher volume produces a more intense fire show.

* Lower volumes produce a more reactive fire show.

Fire show may vary from song to song, genre or fidelity of audio clip. "Beat to Music" works with any audio including music, audio books, pod-casts and stories.

5. Use the volume control knob on the unit to adjust speaker volume up or down.

POWER DOWN "BEAT TO MUSIC":

1. Turn off the "Beat to Music" button.

2. Turn gas knob to OFF or to "Fire Only" mode.

MAINTENANCE

1. The appliance should be inspected before initial use and inspected at least annually by a qualified service technician.
2. Tampering or failure to follow all directions and warnings is DANGEROUS and voids all warranties. Any component found to be faulty or damaged must be replaced by a qualified service technician with an approved component.
3. This unit is designed for the valve to be fully opened from the fuel source. If not operating at full fuel flow, black smoke may start to occur. Always make certain that the valve on the gas tank is in the full open position during operation of the unit to prevent smoke.
4. Periodically remove the glass crystals and examine the burner unit and its components. If the components are dirty, clean with soft brush and soapy water solution before carefully replacing. Also examine the area around the burner. Any dirt or foreign material, such as spider webs or nests should be removed. This will ensure trouble-free operation.
5. Periodically check the hose that connects to the gas cylinder to ensure that it is not cracked or damaged in any way. Perform leak tests at least annually and replace the hose when excessive wear or damage is observed.

STORAGE

STORAGE OR NON-USE:

- Store the LP gas tank outdoors in a well-ventilated place.
- Do not store the LP gas tank in direct sunlight or near a source of heat or combustion.
- If you intend to store the fire pit indoors, disconnect and remove the LP gas tank first. Disconnected tanks must have a dust cap installed and must not be stored in a building, garage or any other enclosed area.
- Keep out of the reach of children.
- When the LP gas tank is connected to the gas fire pit, the gas fire pit and LP gas tank must be stored outside in a well-ventilated place.

STORAGE INSTRUCTIONS

1. Do not move or store this gas fire pit until the fire has been extinguished and the appliance is cool to the touch.
2. Disconnect the gas source and install the valve plug in the 20lb LP tank.
3. Store the fully assembled unit in a ventilated location away from children and pets.
4. Turn power button off when not using the unit.

TROUBLESHOOTING

PROBLEM	POSSIBLE CAUSE	SOLUTION
Burner won't light.	Propane cylinder is frosted over.	Wait until the propane cylinder warms up and becomes unfrosted.
	Blockage in orifice.	Clear blockage.
	Control knob is not in ON position.	Turn control knob to ON.
Burner flame is low.	Gas pressure is low.	Turn cylinder valve OFF and replace cylinder.
	Outdoor temperature is less than 40°F and tank is less than 1/4 full.	Use a full cylinder.
	Control knob not fully ON.	Check burner and orifices for blockage.
Carbon build-up.	Blockage in burner holes.	Remove blockage from burner holes.
Thick black smoke.	Regulator hose is kinked.	Straighten hose of all bends or kinks.

WARRANTY

ONE-YEAR LIMITED WARRANTY

- The Limited Warranty described above is extended only to the original end-use purchaser and is non-transferable. It does not include parts or labor to repair damage caused by mishandling, accident, negligence, misuse, normal wear and tear, normal cosmetic deterioration, or damage caused by environmental conditions. While necessary repairs or maintenance on your Ukiah Co. product can be performed by any company, we recommend that you use only authorized Ukiah dealers and parts. Incorrectly performed or improper repair or maintenance voids this Limited Warranty.
- There are no express warranties except as listed above.
- The purchaser assumes all risks in the assembly, operation, and maintenance of this unit.
- Failure to follow the warnings and operational instructions contained in this manual can result in personal injury and/or property damage.
- This Limited Warranty is in lieu of all other express warranties, and is the sole and exclusive warranty provided by Ukiah Co. Ukiah Co. disclaims all warranties for products that are purchased from sellers other than authorized distributors or retailers, including the warranty of fitness for a particular purpose or the warranty of merchantability.
- Upon expiration of this Limited Warranty, Ukiah Co. disclaims and will not be liable or responsible for any other warranty, including express and implied warranties. This means that to the extent allowed by law, starting on the applicable Ukiah Co. Limited Warranty expiration date, all Ukiah Co. Products are provided on an "as is" basis, and Ukiah Co. disclaims all warranties and conditions with respect to the Ukiah Co products, whether implied, express, or statutory, including the implied warranties of fitness for a particular purpose, merchantability, non-infringement of third-party rights, title, quiet enjoyment, availability, quality of service or results, satisfactory quality, accuracy, and any warranties arising from any course of dealing, usage or trade practice in connection with such products.
- Ukiah Co. further disclaims any implied or express warranty of, and assumes no responsibility for, defects in workmanship caused by third parties.
- In no event will Ukiah Co., its directors, officers or agents be liable to the purchaser of this device or any third party, whether in tort, or in contract, or on any other basis, for any indirect, special, punitive, exemplary, consequential, or incidental damage, loss, or cost arising in connection with or out of the sale, use, maintenance, or inability to use the product, even if Ukiah Co. or its directors, officers, or agents have been advised of the possibility of such damages, losses, or costs, or if such damages, losses, or costs are foreseeable. In no event will Ukiah Co. or its directors, officers, or agents be liable for any direct damages, losses, or costs that exceed the purchase price of the product.
- This Limited Warranty gives the purchaser specific legal rights, and the purchaser may also have other rights which vary from jurisdiction to jurisdiction. The provisions of the United Nations Convention on Contracts for the Sales of Goods shall not apply to this Limited Warranty or the sale of products covered by this Limited Warranty.

- Some jurisdictions do not allow the exclusion or limitation of incidental or consequential damages so the above limitations or exclusions may not apply to you, and in such cases, the provisions of this Limited Warranty are in addition to and not a modification of or subtraction from any statutory warranties and other rights and remedies provided by law.
- No distributor, dealer, retailer, reseller, vendor, sales person or other person is authorized by Ukiah Co. to modify the terms of this Limited Warranty or to make any warranty, promise, or representation which is different from, in addition to, or inconsistent with the warranties, promises, or representations expressly set forth in this Limited Warranty.
- If any provision of this Limited Warranty is found to be invalid or unenforceable, then the remainder shall have full force and effect, and the invalid provision shall be enforced to the maximum extent permitted by law to effectuate the purposes of this Limited Warranty.
- This Agreement shall be governed by the laws of Washington. Unless Ukiah Co. consents in writing to the selection of an alternative forum, the Courts of Washington shall have sole jurisdiction over any dispute arising out of or in connection with this Limited Warranty or any Ukiah Co. product.

By purchasing this unit, you agree to follow all startup and safety instructions. You also agree that this product will not be used for any other reason as it was intended. Any questions or comments about our product, please click the "Contact us" link at www.UkiahCo.com

U.S. INSTALLATION CODE:

Installation must conform with local codes or, in the absence of local codes, with the latest edition of the National Fuel Gas Code, ANSI Z223. 1/NFPA 54.

CANADIAN INSTALLATION CODES:

These instructions, while generally acceptable, do not necessarily comply with the Canadian installation codes, particularly with piping above and above ground. In Canada, the installation of this appliance must comply with local codes and/or the latest edition of Standard CAN/CSA-B149.2 (Propane Storage and Handling Code).

IGNITE THE MUSIC™



UKIAH

WWW.UKIAHCO.COM