

Paragon Frameless Door

w/Oval - Pull Handle

(exploded view, left hand hinge shown)

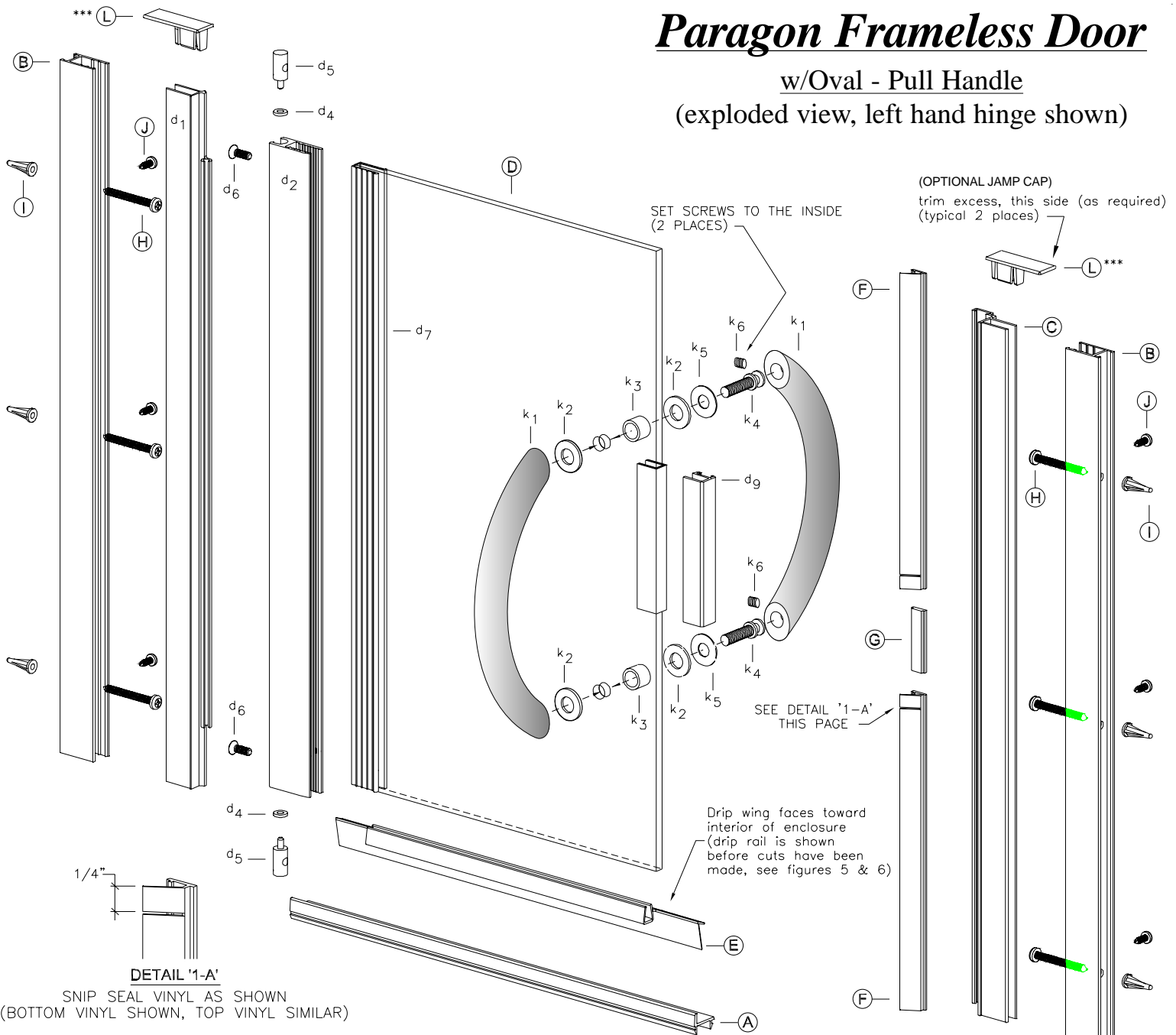

DETAIL '1-A'

SNIP SEAL VINYL AS SHOWN
(BOTTOM VINYL SHOWN, TOP VINYL SIMILAR)

(*) denotes Vinylns used with 3/16" glass

PART LIST OF MATERIAL

KEY LETTER	PART NUMBER	DESCRIPTION	QTY	KEY LETTER	PART NUMBER	DESCRIPTION	QTY
A	901	SILL	1	E	C 914 C	DRIP RAIL	1
B	903	WALL JAMBS	2	F	c956c	SEAL VINYL (Strike Post)	2
C	928	STRIKE POST	1	G	98-45	MAGNET (Strike Post)	1
D	----	DOOR ASSEMBLY	1	H	6-8114PHP	INSTALLATION SCREWS	6
d1	920	Door Hinge Post	1	I	1329	PLASTIC SCREW ANCHORS	6
d2	923	Door Hinge Stile	1	J	638PHPT	ADJUSTMENT SCREWS	6
d3	----	(designation not used)	---	K	TA8-CGNW	OVAL PULL ASSEMBLY	1
d4	cp148tw	Door Hinge Washer	2	k1	---	Handles (set)	1
d5	cp932	Door Hinge Bushing	2	k2	---	Plastic Washers	4
d6	812FHP	Door Assembly Screw	2	k3	---	Sleeve Bushings	2
d7	c944b	Door Glazing Vinyl	---	k4	---	Screw Post	2
*d8	c945b	Door Strike Vinyl	1	k5	---	Metal Washers	2
*d9	931M	Door Strike	1	k6	---	Set Screw	2
d10	----	Door Glass, 3/16" thk	1	L	*** cp903	JAMP CAP (wall jamb)	2

Vinylns below are used with 1/4" glass

d7	c954b	Door Glazing Vinyl	---
L d8	c955b	Door Strike Vinyl	1

1. Measure the base opening along center of shower curb as shown in figure 1, then trim Sill (A) to 1/16" less than measurement obtained.

2. With high lip toward exterior of enclosure, position the Sill at center of shower curb. Temporarily tape Sill to shower curb to prevent movement.

Note: For **Door Only** Installations; Trim Wall Jambs (B) to the same height as the Strike Post (C) before proceeding; otherwise leave Wall Jambs as they are (no trimming) and continue the installation

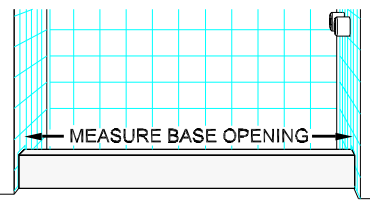

figure 1

3. Place Wall Jambs (B) on to ends of Sill (A) and up against shower walls as shown in figure 2. Plumb the Jambs, then pencil mark their installation holes locations on shower walls (3 per jamb). Remove Wall Jambs. Use a 3/16" drill bit (designed to drill through material you are working with) to drill 1-1/4" deep installation holes in locations previously marked. Insert Plastic Screw Anchors (I) into holes.

4. Reposition Wall Jambs (B) as before and secure Jambs to walls using the six(6) 1-1/2" Installation Screws (H) provided (3 per jamb).

5. Decide from which side your Door Assembly (D) is to hinge (left or right, your choice). Install Glazing Vinyl (d7) onto hinge side of glass as shown in the exploded view. Begin glazing at top of glass edge and work down.

6. Before installing the Hinge Stile (d2), wet the Glazing Vinyl (d7) with some diluted liquid soap (do not, wet the inside of vinyl, as it will slip off the glass). Insert the Hinge Stile (d2) over the Glazing Vinyl and tap into place (with a rubber mallet) until the Post is firmly seated (*top of Hinge Post must be flush with top of glass*).

7. Insert the Hinge Post (d1) into the Hinge Stile (d2) as shown in figure 3. Take a minute to check the door rotation (*is it the correct rotation for your configuration*)? If it is not, then make it so. When satisfied, proceed.

8. Insert Hinge Washer (d4) and Hinge Bushing (d5) into Hinge Stile (d2) as shown in figure 3. Rotate Hinge Post (d1) out of the way and secure the bushing with one(1) Door Assembly Screw (d6) as shown in figure. Repeat step for opposite end.

9. Pick Door Assembly up and insert its Hinge Jamb (d1) into the Wall Jamb from which it is to swing. On strike edge of glass, center and install Door Strike Vinyl (d8) as shown in exploded view - sheet 1. Insert Door Strike (d9) over Vinyl (d8) and tap into place (with a rubber mallet) until Strike is firmly seated. Carefully trim any excess vinyl as required.

10. Insert Strike Post (C) into appropriate Wall Jamb. Measure from bottom of Strike Post (where it sits on Sill) to the bottom of the Door Pull (d9). Trim bottom Seal Vinyl (F) to a 1/4" more than measurement obtained. Insert trimmed Seal Vinyl into Strike Post as indicated in exploded view, sheet - 1. Next insert Magnet Strip (G) into Strike Post. Finally insert remaining Vinyl Seal (F) and trim top excess as required. Snip Seal Vinyl as shown on sheet - 1, Detail '1 - A'.

11. Adjust Door Assembly and Strike Post along curb as required. Note: Bottom of Door Assembly must always remain parallel to Sill in order for door to operate properly. When satisfied with door operation, secure Hinge Post and Strike Post to the Wall Jambs using 638PHPT Adjustment Screws (J), see exploded view - sheet 1.

12. If Jamb Caps (L) were purchased, install the End Caps (L) at both the hinge side and the strike side of the door as shown in exploded view - sheet 1. Trim the End Caps to required lengths before installing.

13. Install oval pull Handles (K) by backing out the two Set Screws (k6) and pulling the Handles (k1) apart. Unscrew the two Screw Posts (k4) to disassemble bushings and washers. Slip a metal Washer (k5), a plastic Washer (k2) and Sleeve Bushing (k3) onto the Screw Post (k4) as shown in Figure 4. Insert it into the glass hole as shown and attach the outside oval pull Handle, (do not forget to attach plastic washer). Hand tighten the screw and repeat step for bottom portion. When done . . . carefully tighten down assembly with a screw driver. Take inside Handle (see explode view sheet 1) and insert it onto the Screw Post heads as shown. Finish oval pull Handle installation by tightening down the two set screws.

14. With drip wing positioned toward inside of shower enclosure, Insert Drip Rail (E) onto the bottom edge of the Door Assembly (D) as shown in exploded view - sheet 1 and figure 5. Now snug the Drip Rail up to the vertical Vinyl; mark the edge of the door glass on the rail and cut off the excess as shown in figure 6.

From inside the shower enclosure, close the shower door and mark where drip wing needs to be notched for proper closure against door strike (see figure 7). Notch the drip rail as required and reposition the Drip Rail on the door and check for fit.

Once you are satisfied with the Drip Rail fit, remove the Drip Rail and run a bead of clear mildew resistant silicone down the full length the Drip Rail cavity (this will insure a secure Drip Rail installation when you reposition it on the glass). Reposition the Drip Rail on the glass and press firmly into place.

15. Run a bead of clear mildew resistant caulking down the full length of each Wall Jamb **outside** where the Jambs meet the Walls. Now run a bead **outside** where the Sill meets the curb. Follow caulking manufacturer's instructions before using shower (normally 24 hours). Installation is now complete.

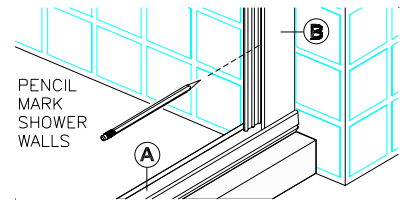

figure 2

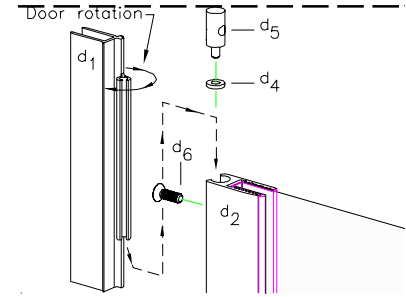

figure 3

(Door always opens in direction shown above)
Figure shows installation for a left hand hinged door

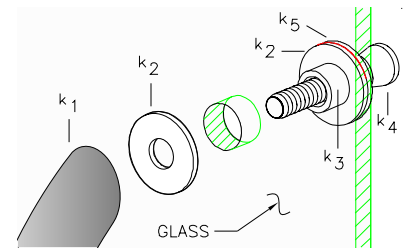

figure 4

Install Oval-pull Handles as shown above
(Install outside Handle first as shown, then install the inside Handle)

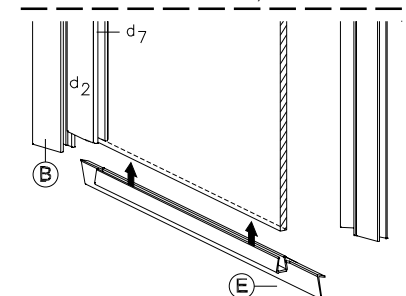

figure 5

Insert Drip Rail unto bottom edge of glass

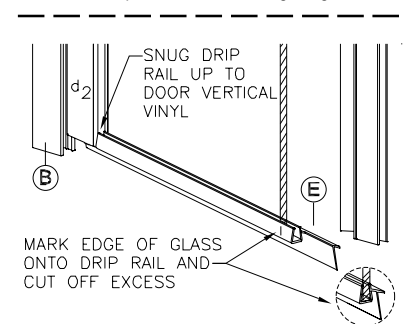

figure 6

Snug Drip Rail up against the vertical Vinyl, then cut off the excess as shown in figure.

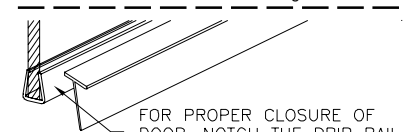
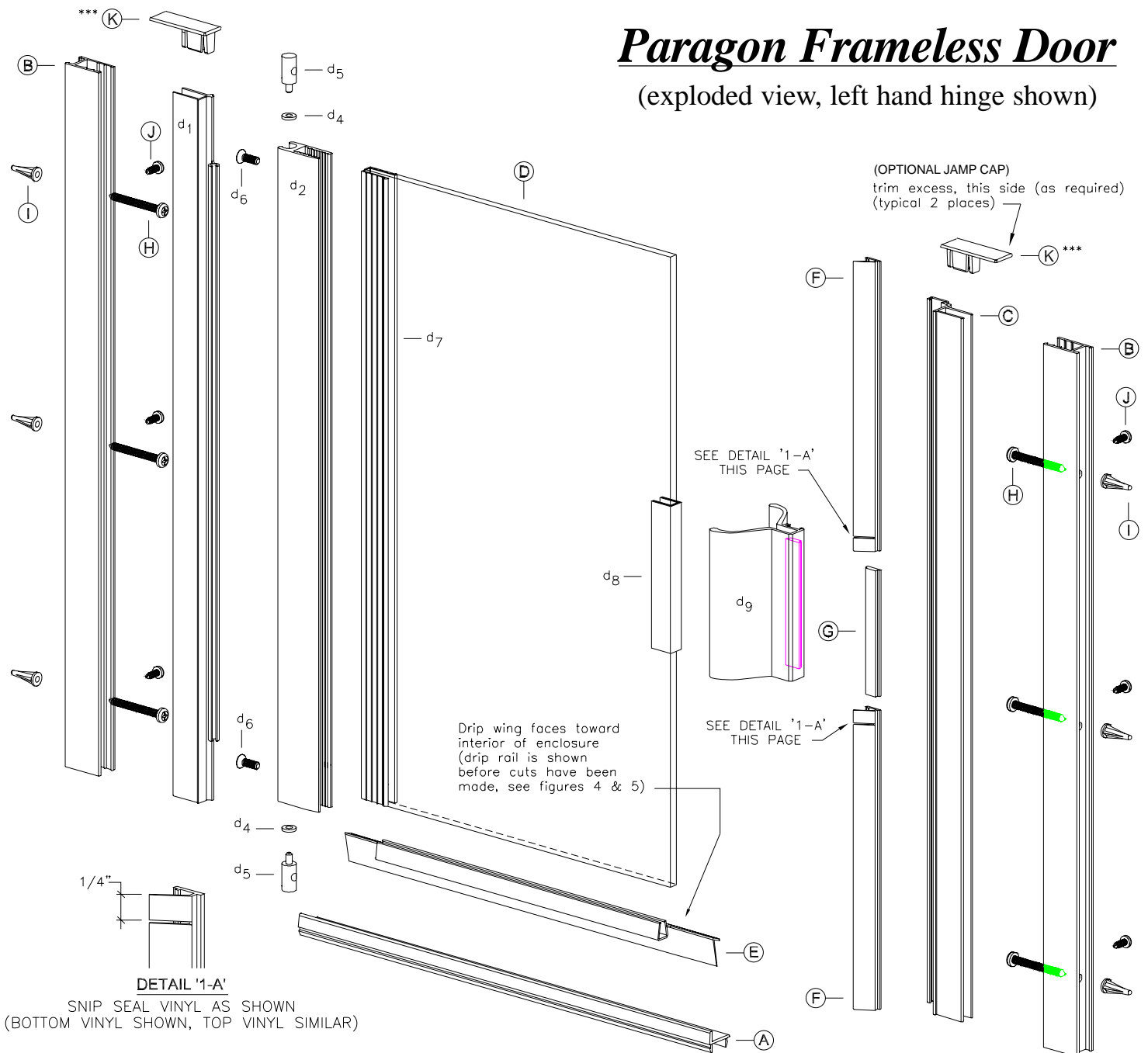

figure 7

FOR PROPER CLOSURE OF DOOR, NOTCH THE DRIP RAIL AT STRIKE SIDE

Paragon Frameless Door

(exploded view, left hand hinge shown)



(*) denotes Vinyls used with 3/16" glass

PART LIST OF MATERIAL

KEY LETTER	PART NUMBER	DESCRIPTION	QTY	KEY LETTER	PART NUMBER	DESCRIPTION	QTY
A	901	SILL	1	E	C 914 C	DRIP RAIL	1
B	903	WALL JAMBS	2	F	c956c	SEAL VINYL (Strike Post)	2
C	928	STRIKE POST	1	G	98-45	MAGNET (Strike Post)	1
D	----	DOOR ASSEMBLY	1	H	6-8114PHP	INSTALLATION SCREWS	6
d1	920	Door Hinge Post	1	I	1329	PLASTIC SCREW ANCHORS	6
d2	923	Door Hinge Stile	1	J	638PHPT	ADJUSTMENT SCREWS	6
d3	----	(designation not used)	---	*** K	cp903	JAMB CAP (wall jamb)	2
d4	cp148tw	Door Hinge Washer	2				
d5	cp932	Door Hinge Bushing	2				
d6	812FHP	Door Assembly Screw	2				
* d7	c944b	Door Glazing Vinyl	---				
* d8	c945b	Door Pull Glazing Vinyl	1				
d9	931	Door Pull	1				
d10	----	Door Glass, 3/16" thk	1				

Vinyls below are used with 1/4" glass

d7	c954b	Door Glazing Vinyl	---
d8	c955b	Door Pull Glazing Vinyl	1

*** Jamb Caps are optional and are ordered separately.

1. Measure the base opening along center of shower curb as shown in figure 1, then trim Sill (A) to 1/16" less than measurement obtained.

2. With high lip toward exterior of enclosure, position Sill at center of shower curb. Temporarily tape Sill to shower curb to prevent movement.

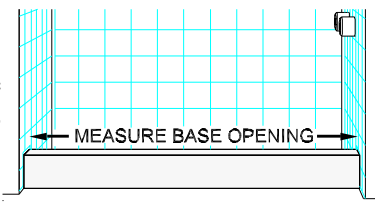

figure 1

Note: For **Door Only** Installations; Trim Wall Jambs (B) to the same height as the Strike Post (C) before proceeding; otherwise leave Wall Jambs as they are (no trimming) and continue the installation

3. Place Wall Jambs (B) on to ends of Sill (A) and up against shower walls as shown in figure 2. Plumb the Jambs, then pencil mark their installation holes locations on the shower walls (3 per jamb). Remove Wall Jambs. Use a 3/16" drill bit (designed to drill through material you are working with) to drill 1-1/4" deep installation holes in locations previously marked. Insert Plastic Screw Anchors (I) into holes.

4. Reposition Wall Jambs (B) as before and secure Jambs to walls using the six(6) 1-1/2" Installation Screws (H) provided (3 per jamb).

5. Decide from which side your Door Assembly (D) is to hinge (left or right, your choice). Install Glazing Vinyl (d7) onto hinge side of glass as shown in the exploded view. Begin glazing at top of glass edge and work down.

6. Before install Hinge Stile (d2), wet the Glazing Vinyl (d7) with some diluted liquid soap (do not, wet the inside of vinyl, as it will slip off the glass). Insert the Hinge Stile (d2) over the Glazing Vinyl and tap into place (with a rubber mallet) until the Post is firmly seated (*top of Hinge Post must be flush with top of glass*).

7. Insert the Hinge Post (d1) into the Hinge Stile (d2) as shown in figure 3. Take a minute to check the door rotation (*is it the correct rotation for your configuration?*) If it is not, then make it so. When satisfied, proceed.

8. Insert Hinge Washer (d4) and Hinge Bushing (d5) into Hinge Stile (d2) as shown in figure 3. Rotate Hinge Post (d1) out of the way and secure the bushing with one(1) Door Assembly Screw (d6) as shown in figure. Repeat step for opposite end.

9. Pick Door Assembly up and insert its Hinge Jamb (d1) into the Wall Jamb from which it is to swing. On strike edge of glass, center and install Door Pull Vinyl (d8) as shown in exploded view. Insert Door Pull (d9) over Vinyl (d8) and tap into place (with a rubber mallet) until Door Pull is firmly seated.

10. Insert Strike Post (C) into appropriate Wall Jamb. Measure from bottom of Strike Post (where it sits on Sill) to the bottom of the Door Pull (d9). Trim bottom Seal Vinyl (F) to a **1/4" more** than measurement obtained. Insert trimmed Seal Vinyl into Strike Post as indicated in exploded view. Next insert Magnet Strip (G) into Strike Post. Finally insert remaining Vinyl Seal (F) and trim top excess as required. Snip Seal Vinyl as shown on sheet - 1, Detail '1 - A'.

11. Adjust Door Assembly and Strike Post along curb as required. Note: Bottom of Door Assembly must always remain parallel to Sill in order for door to operate properly. When satisfied with door operation, secure Hinge Post and Strike Post to the Wall Jambs using 638PHPT Adjustment Screws (J), see exploded view - sheet 1.

12. If Jamb Caps (K) were purchased, install the Jamb Caps (K) at both the hinge side and the strike side of the door as shown in exploded view - sheet 1. Trim the End Caps to required lengths before installing. Next, Install the Rail End Cap (L) on to end of Door Rail (d3) as shown in exploded view - sheet 1.

13. With drip wing positioned toward inside of shower enclosure, Insert Drip Rail (E) onto the bottom edge of the Door Assembly (D) as shown in exploded view - sheet 1 and figure 4. Now snug the Drip Rail up to the vertical Vinyl; mark the edge of the door glass on the rail and cut off the excess as shown in figure 5.

From inside the shower enclosure, close the shower door and mark where drip wing needs to be notched for proper closure against door strike (see figure 6). Notch the drip rail as required and reposition the Drip Rail on the door and check for fit.

Once you are satisfied with the Drip Rail fit, remove the Drip Rail and run a bead of clear mildew resistant silicone down the full length the Drip Rail cavity (this will insure a secure Drip Rail installation when you reposition it on the glass). Reposition the Drip Rail on the glass and press firmly into place.

14. Run a bead of clear mildew resistant caulking down the full length of each Wall Jamb **outside** where the Jambs meet the Walls. Now run a bead **outside** where the Sill meets the curb. Follow caulking manufacturer's instructions before using shower (normally 24 hours). Installation is now complete.

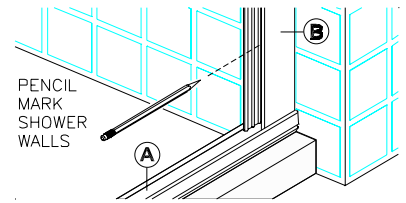

figure 2

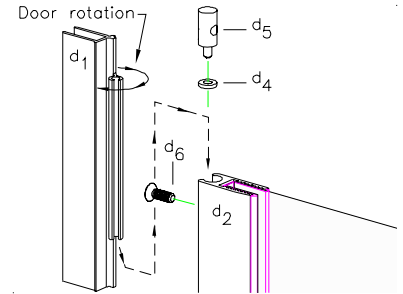

figure 3

(Door always opens in direction shown above)
Figure shows installation for a left hand hinged door

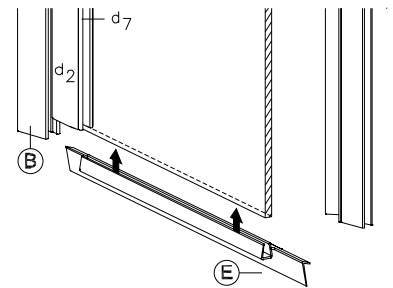

figure 4

Insert Drip Rail unto bottom edge of glass

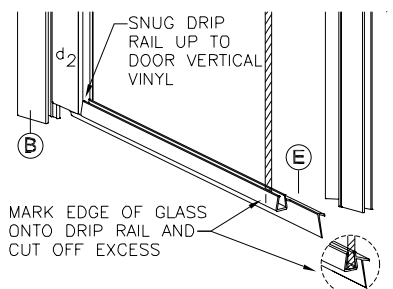

figure 5

Snug Drip Rail up against the vertical Vinyl, then cut off the excess as shown in figure.



figure 6

FOR PROPER CLOSURE OF DOOR, NOTCH THE DRIP RAIL AT STRIKE SIDE