

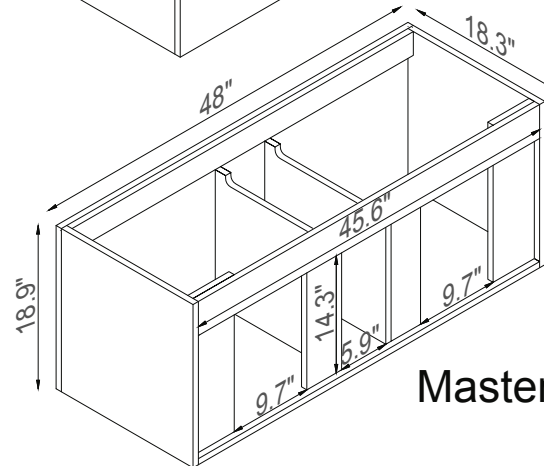

Streamline

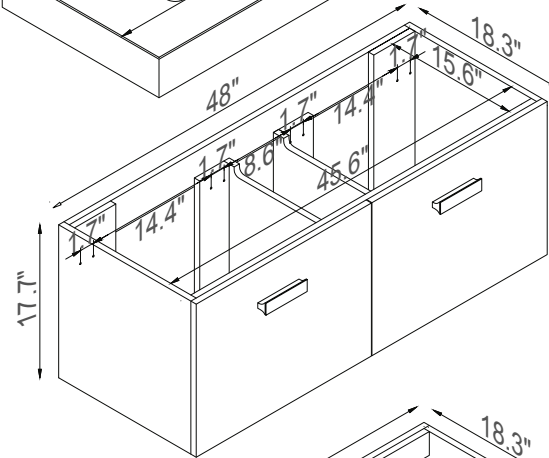
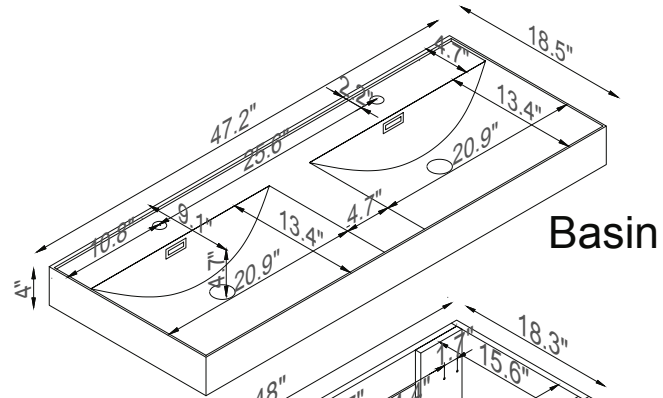

K1801-170-48-51