

58150

Installation Instructions

1. Turn off water supply.
2. Remove handle cap and retaining screw.
3. Remove handle by pulling straight out.
4. Place new handle on stem and tighten with retaining screw.
5. Replace handle cap and turn on water supply.

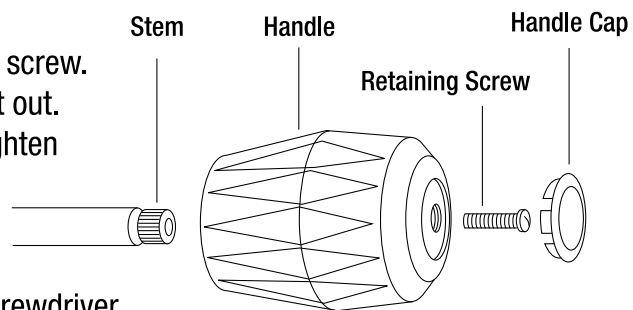

Tools needed for installation: • Screwdriver