

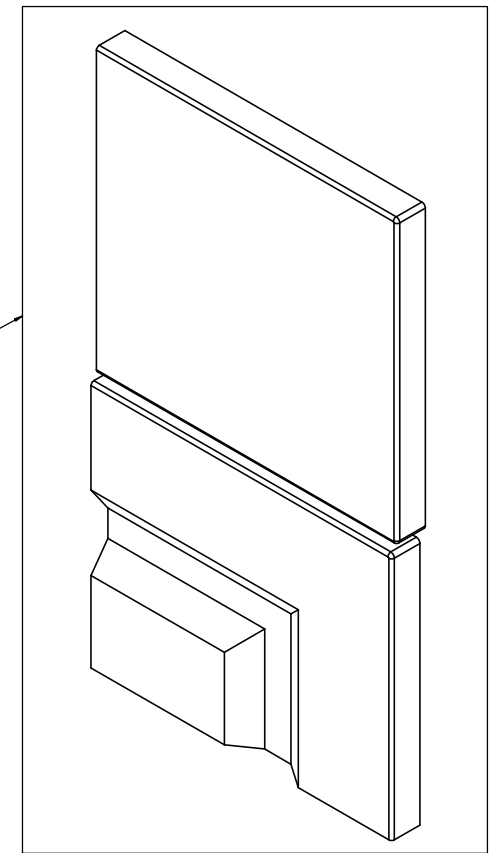

Item ID	Front Thickness [in] mm	Door Thickness [in] mm
BT2135B-WH	[.63] 16	[.63] 16

**This profile
belongs to
BT2135B-WH**

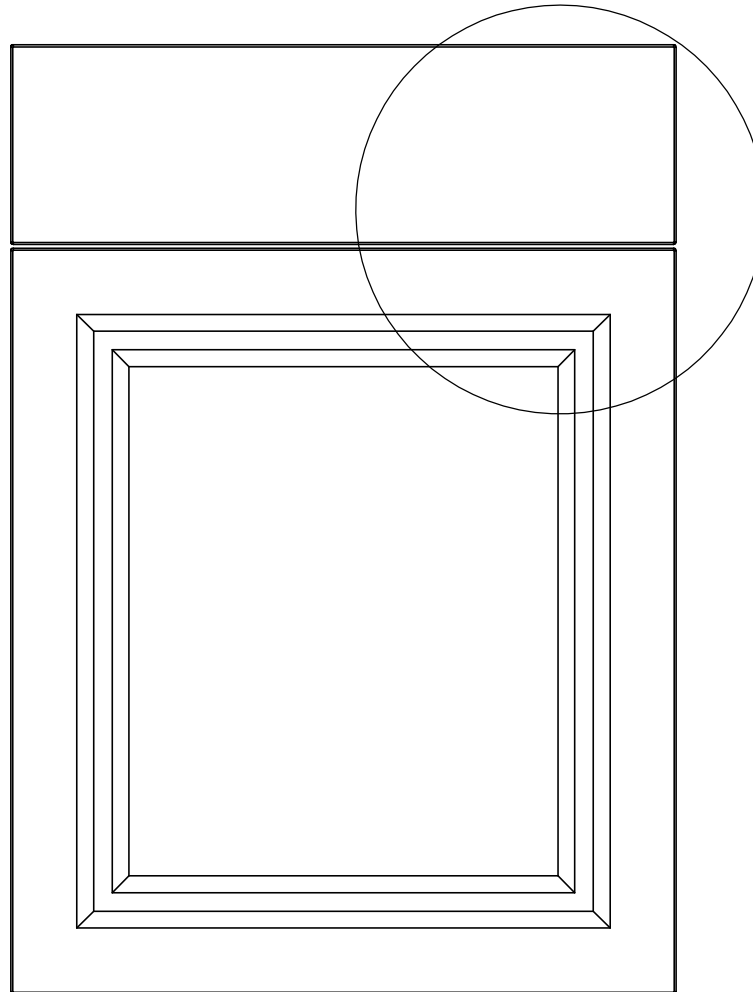

Detailed View

Profile: Benton White	
PROPRIETARY AND CONFIDENTIAL THE INFORMATION CONTAINED IN THIS DRAWING IS THE SOLE PROPERTY OF WOODCRAFTERS. ANY REPRODUCTION IN PART OR AS A WHOLE WITHOUT THE WRITTEN PERMISSION OF WOODCRAFTERS IS PROHIBITED.	UNLESS OTHERWISE SPECIFIED DIMENSIONS ARE IN MM AND [INCHES] TOLERANCES ARE +.039[1]-.039[1] SCALE:1:2
	

ITEM	ITEM ID	"D" in
1	BT1884P-BT	24.67
2	BT1884P-WH	24.51
3	BT1884P-RC	24.67
4	CM1884P-DK	24.67
5	CM1884P-KG	24.51
6	EH1884P-GB	24.67

REV	ECO#	DESCRIPTION	APRVD BY DATE
0		Released	CR Abr. 14, 2017
1		Pantrys Construction Improvements, change backing from 3mm to 12.7mm	CR Jul. 24, 2018

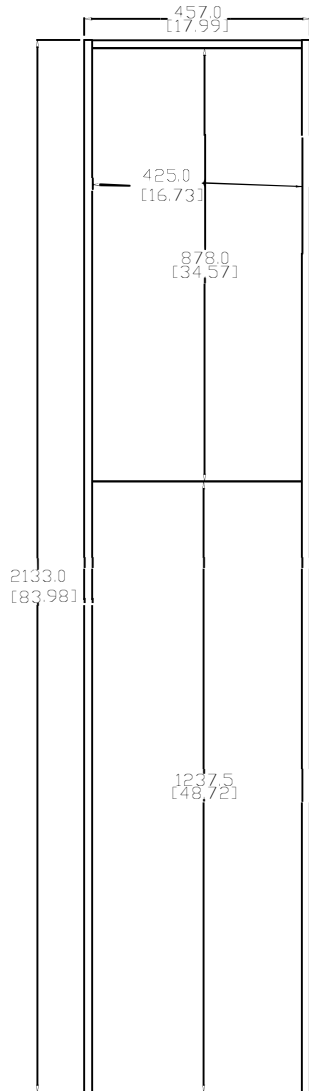

BACK
VIEW

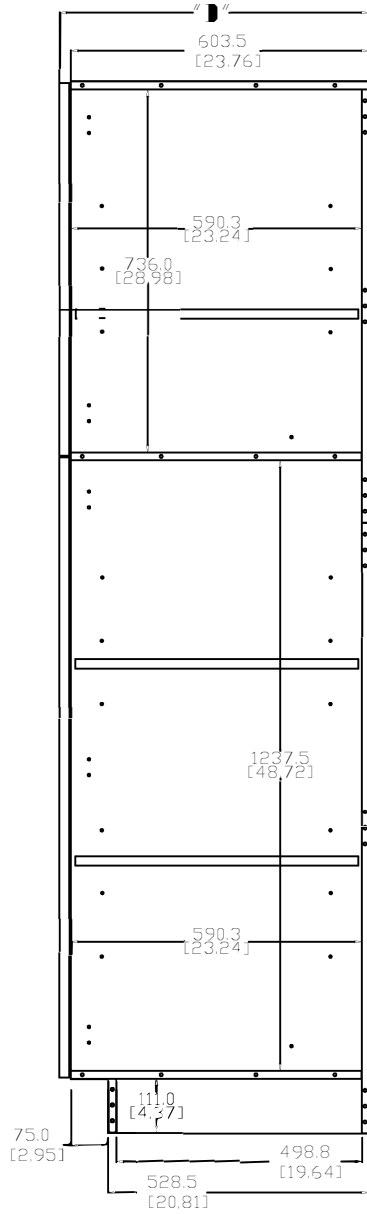

SIDE
VIEW

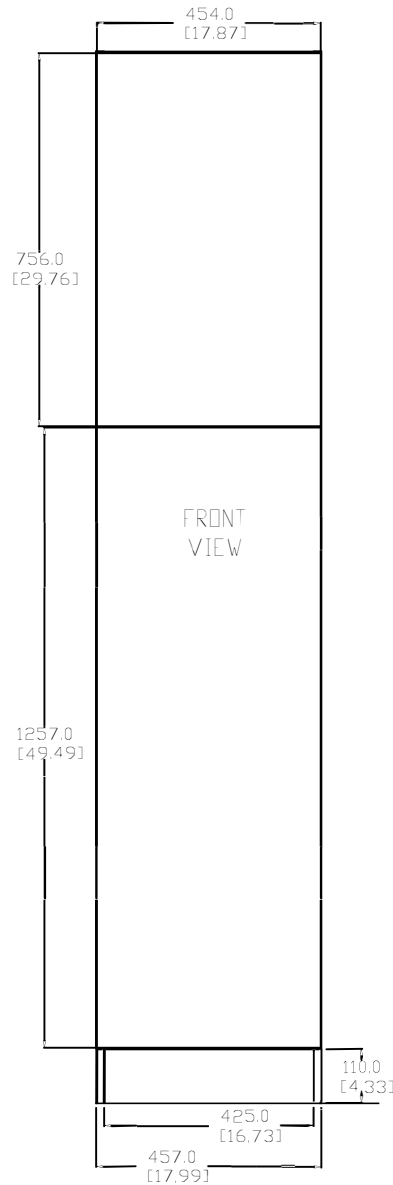

FRONT
VIEW

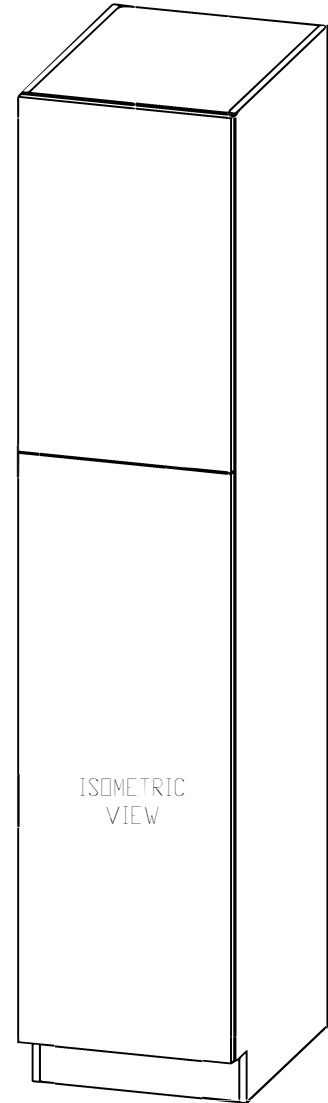

ISOMETRIC
VIEW

PROPRIETARY AND CONFIDENTIAL
THE INFORMATION CONTAINED IN THIS DRAWING IS THE
SOLE PROPERTY OF WOODCRAFTERS HOME PRODUCTS
L.L.C. ANY REPRODUCTION IN PART OR AS A WHOLE
WITHOUT THE WRITTEN PERMISSION OF WOODCRAFTERS
HOME PRODUCTS L.L.C. IS PROHIBITED.

UNLESS OTHERWISE SPECIFIED
DIMENSIONS ARE IN mm
and [inches]
AND TOLERANCES ARE
+/- 1 [0.04]

DRAWN BY:	Carlos Reyes
CHECKED BY:	Juan Sanchez
APPROVED BY:	Alexandro H
DO NOT SCALE DRAWING	SCALE: 1:1

TITLE:	PB Pantry Gabinet			
PART NO:	PAGE:	1 OF 1	REV:	1