



# THE BASEMENT WATCHDOG

## BIG DOG+ CONNECT

# A/C-D/C Battery Backup Sump Pump System

# Instruction Manual & Safety Warnings



## Table of Contents

<b>Important Safety Warnings and Instructions</b>		Battery fluid is low	11
		Battery problem	12
Electrical precautions	1	Cleaning battery terminals	12
Battery preparation	1	Replacing the battery	13
Battery precautions	1	Power failure	14
		Pump failure	14
<b>Introduction</b>		Battery fuse has blown	14,15
Items included in system	2	Pump was activated	15
Additional items needed	2	Replacing the pump	15
System specifications	2	Battery charge level	15
Replacement parts list	2	Pumping	15
		Charging battery	15
		System operating	15
<b>Pump &amp; Pipe Installation Instructions</b>			
Installation options	3	<b>Testing the System</b>	
Direct discharge to outside	4	Testing the float switch	16
Connection to existing discharge	5		
Direct discharge for narrow sumps	6	<b>Using the Remote Notification</b>	
Connection to existing discharge for narrow sumps	7	Remote Terminal	16
		Remote Alarm	16
<b>Battery Instructions</b>	8	<b>USB Data Port</b>	16
		<b>Connect Modules</b>	16
<b>Control Unit Connections</b>		<b>Maintenance Check List</b>	16
Positioning the float switch	9	<b>Parts &amp; Service Information</b>	
Connecting the pump	10	Technical support	16
Installing the battery fluid sensor	10	<b>Troubleshooting Guide</b>	17
Connecting the battery	10	<b>Other Products</b>	18
Connecting two batteries	10	<b>Warranty</b>	19
Connecting to AC power	10		
<b>Understanding the Warning Lights and Alarms</b>			
Silencing the alarm	11		

This manual is for the systems that have the BWD12-120C-A backup controller, which can accommodate maintenance or maintenance free batteries. See pages 2 and 8 for additional information.

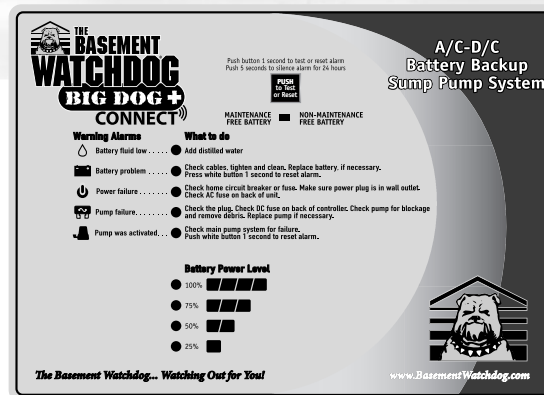

**IMPORTANT:** Even if you have the Basement Watchdog backup sump pump system installed by someone else, you must read and follow the safety information contained in this manual. Failure to do so could result in property damage, serious injury, or death.

## Important Safety Warnings & Instructions

**SAVE THESE INSTRUCTIONS.** This manual contains important SAFETY WARNINGS and OPERATING INSTRUCTIONS for the Basement Watchdog Big Dog battery backup sump pump system. You will need to refer to it before attempting any installation or maintenance. **ALWAYS** keep these instructions with the unit so that they will be easily accessible.

Failure to read and follow these warnings and instructions could result in property damage, serious injury, or death. It is important to read this manual, even if you did not install the Basement Watchdog backup sump pump system, since this manual contains safety information regarding the use and maintenance of this product. **DO NOT DISCARD THIS MANUAL.**

### ELECTRICAL PRECAUTIONS

#### **⚠ WARNING**

**This installation must be in accordance with the National Electric Code and all applicable local codes and ordinances.**

#### **⚠ DANGER**

**Risk of electrical and fire hazard. May result in death, serious injury, shock or burns.**

**To help reduce these risks, observe the following precautions:**

- **DO NOT** walk on wet areas of the basement until all power has been turned off. If the main power supply is in a wet basement, call an electrician.
- **NEVER** handle the control unit with wet hands or while standing on a wet surface.
- **ALWAYS** unplug the control unit and disconnect the cables from the battery before attempting any maintenance or cleaning.
- **ALWAYS** unplug the main pump when installing or servicing the backup pump or float switch to avoid electric shock.
- **DO NOT** expose the control unit to water, rain or snow.
- **DO NOT** pull the cord when disconnecting the control unit. Pull the plug.

- **MAKE SURE THERE IS A PROPERLY GROUNDED RECEPTACLE AVAILABLE.** This pump is wired with a 3-prong grounded plug. To reduce the risk of electrical shock, be certain that it is only connected to a properly grounded 3-prong receptacle. If you have a 2-prong receptacle, have a licensed electrician replace it with a 3-prong receptacle according to local codes and ordinances.
- **DO NOT** use an extension cord unless absolutely necessary. If an extension cord must be used, be sure the plug has the same configuration as the plug on the control unit.
- **DO NOT** use an attachment not recommended or sold by the manufacturer. It may result in a risk of fire or injury from an electrical shock.
- **DO NOT** use pump in pits handling raw sewage, salt water or hazardous liquids. This system is for ground water use only.
- **DO NOT** operate the computer control unit if it has received a sharp blow, been dropped, or otherwise damaged in any way.
- **DO NOT** disassemble the control unit.
- **DO** protect the electrical cord from sharp objects, hot surfaces, oil and chemicals. Avoid kinking the cord.
- **MAKE SURE** the supply circuit has a fuse or circuit breaker rated to handle the power requirements of this system.

When service is required, contact Glentronics technical support at **800-991-0466, option #3**, or send an e-mail to **service@glentronics.com**. Return the control unit to the manufacturer for any repairs at the following address:

Glentronics, Inc.  
645 Heathrow Drive  
Lincolnshire, IL 60069-4205

### BATTERY PREPARATION

#### **⚠ WARNING / POISON**

**Sulfuric acid can cause blindness or severe burns. Avoid contact with skin, eyes, or clothing. In the event of an accident, flush with water and call a physician immediately. KEEP OUT OF REACH OF CHILDREN.**

**To help reduce these risks, observe the following precautions:**

- Someone should be within range of your voice or close enough to come to your aid when you work near a lead-acid battery.
- Have plenty of fresh water and soap nearby in case battery acid contacts skin clothing or eyes.
- Wear eye and clothing protection and avoid touching your eyes while working with battery acid or working near the battery.
- If battery acid contacts skin or clothing, wash immediately with soap and water. If acid enters eye, immediately flood eye with running cold water for at least 15 minutes and get prompt medical attention.
- Battery posts and terminals contain lead, lead compounds or chemicals known to the State of California to cause cancer, birth defects or other reproductive harm. Wash hands after handling. See <https://www.p65warnings.ca.gov/> for more information.

### BATTERY PRECAUTIONS

#### **⚠ DANGER**

**Explosive gases could cause serious injury or death. Cigarettes, flames or sparks could cause battery to explode in enclosed spaces. Charge in a well-ventilated area. Always shield eyes and face from battery. Keep vent caps tight and level.**

**To help reduce these risks, observe the following precautions:**

- **NEVER** smoke or allow a spark or flame in the vicinity of the battery.
- Use the Basement Watchdog control unit for charging a LEAD-ACID battery only. **DO NOT** use the control unit for charging dry-cell batteries that are most commonly used with home appliances.
- Be sure the area around the battery is well-ventilated.
- When cleaning or adding water to the battery, first fan the top of the battery with a piece of cardboard (or another non-metallic material) to blow away any hydrogen or oxygen gas that may have been emitted from the battery.
- **DO NOT** drop a metal tool onto the battery. It might spark or short-circuit the battery and cause an explosion.

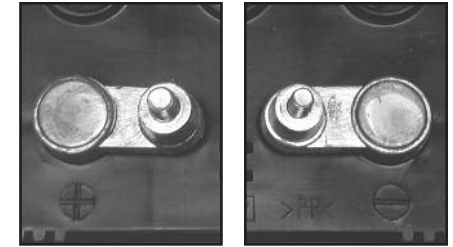

POSITIVE POST HAS LARGER DIAMETER

NEGATIVE POST HAS SMALLER DIAMETER

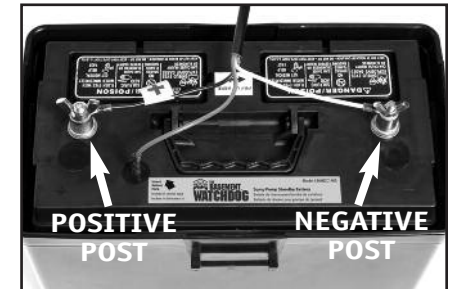

- Remove personal metal items such as rings, bracelets, watches, etc. when working with a lead-acid battery. A short circuit through one of these items can melt it, causing a severe burn.
- **ALWAYS** remove the power cord from the electrical outlet before connecting or disconnecting the battery cables.
- Check the polarity of the battery posts. The POSITIVE (+) battery post usually has a larger diameter than the NEGATIVE (-) post.
- When connecting the battery cables, first connect the small ring on the end of the WHITE wire to the NEGATIVE (-) post of the battery, and then connect the large ring on the end of the BLACK wire to the POSITIVE (+) post of the battery.
- **ALWAYS** keep the cover secured on the battery box by slipping the tabs through the fittings on the front and back of the box.

#### **⚠ DANGER**

**Do not use this system to pump flammable or explosive fluids such as gasoline, fuel oil, kerosene, etc.**

## Introduction

The Basement Watchdog Big Dog backup sump pump system is designed as an emergency backup system to support your main AC sump pump, and it will automatically begin pumping any time the float switch is activated by rising water.

If your main AC pump breaks or is unable to keep up with all the incoming water, the Basement Watchdog pump is capable of running without discharging the battery as long as the AC power is on. As soon as the AC power is interrupted, the battery takes over. Should any malfunction or emergency occur that involves the sump pump, the battery, or the AC power, the Basement Watchdog system will sound an alarm. A light on the display panel of the control unit will indicate the cause of the alarm and the corrective action.

For added reliability, the float switch has, not one, but two floats. Should one float fail to operate, the second float automatically activates the pump.

To extend the battery run time, two batteries may be connected to the Basement Watchdog Big Dog system by purchasing a second battery and acid pack, as well as a set of battery jumper cables. Jumper cables specifically designed for

this use are available from the manufacturer, Glentronics, Inc.

### The Basement Watchdog Sump Pump System includes:

- A control unit with a dual float switch, a battery fluid level sensor, battery cables, a 5 amp AC fuse, and a 25 amp DC fuse
- A plastic wire tie for mounting the float switch
- A pump with a 1½" pipe adapter
- A battery box
- A battery cap with a hole to accommodate the fluid sensor

### You will also need to supply:

- A Basement Watchdog Big Standby Battery (30HDC140S or BW-30F) or Basement Watchdog Maintenance Free (AGM) Standby Battery (BW-27AGM).

**DO NOT** use an automotive battery with this system.

**DO NOT** use a Basement Watchdog Emergency Standby Battery (24EP6 of BW-24F) with this system. It will not run the pump as long as the Big Standby Battery.

The internal construction of some wet cell batteries may not be compatible with this

system. Glentronics can not guarantee the compatibility of other brands of batteries. The use of a Basement Watchdog battery is **HIGHLY** recommended.

- 1½" rigid PVC pipe and fittings
- PVC primer and cement
- A union with hose clamps or a "Y" connector and two (2) check valves, depending on the installation method you use
- A surge protector (recommended)
- Six (6) quarts of 1.265 specific gravity battery acid (only if using a 30HDC140S or BW-30F battery)



### For narrow sump pits you will need some additional parts:

- An "L" bracket at least six (6) inches long (preferably one that will not rust)
- Two (2) stainless steel hose clamps
- One (1) stainless steel screw (#8-32 x 3/4"), a matching washer & nut



### To connect two batteries you will need:

- Two (2) batteries of the same age, type and capacity (so they will have equal power)



- Another battery box
- Two (2) acid packs to fill the dry batteries
- A set of battery cables with rings on both ends to connect the two batteries together (available from Glentronics, Inc.)



Use of a Basement Watchdog Klunkless Check Valve™ will provide quieter operation. (See back cover for more information.)

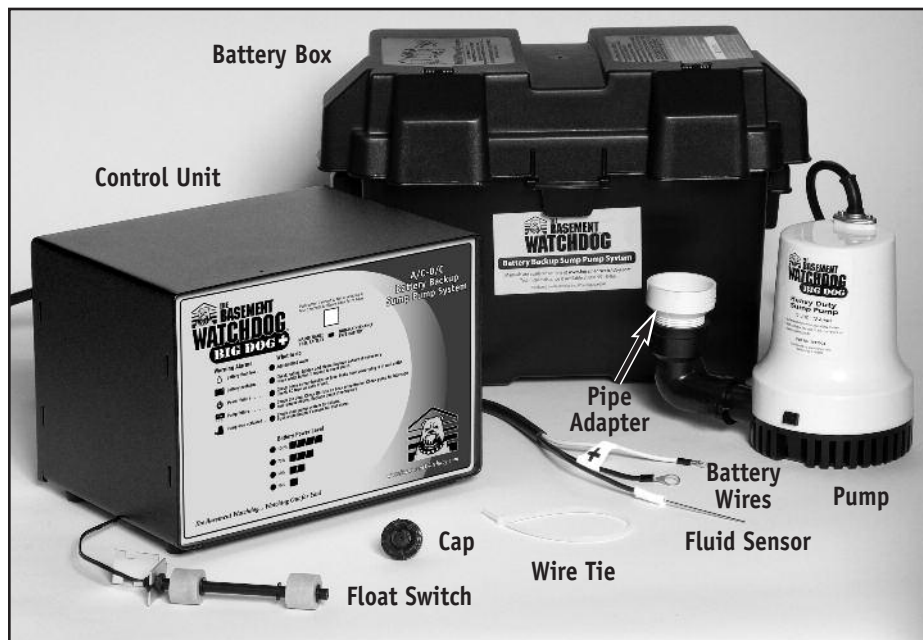

### Replacement Part Numbers

Pump	.....1011003
Float switch assembly	.....1020009
Fluid sensor assembly	.....1014001
Pipe adapter	.....1120002
Battery box	.....1113003
Battery cap with hole	.....1125000
Battery jumper cable for 2 batteries	.....PJC

Call 800-991-0466, option #3 to order parts.

### System Specifications

Power supply requirements	.....115 volts AC
Pumping capacity	.....3500 GPH @ 0'
Pumping capacity	.....2200 GPH @ 10'
Pump dimensions w/elbow	.....7½" H x 9"W
Pump housing & strainer	.....non-corrosive, will not rust
Pump	.....can run dry for short periods of time
Float switch	.....independent, can be set at any level

# Pump & Pipe Installation Instructions

There are two basic methods that can be used to install the pump, a direct discharge to the outside of the building, or a connection to an existing discharge pipe. The same two options apply in very narrow sump pits where the backup pump must be mounted above the main pump.

Use a pit that conforms to all local codes, and check the code to see if a gate valve or ball valve is required.

Whenever possible, install your Basement Watchdog backup pump with a direct discharge to the outdoors. By using this method, there will always be an outlet for the water from the sump. During times of very heavy rain, many storm sewers fill up. If your pump is trying to discharge water into a full sewer, there is nowhere for the water to go. By discharging directly outdoors, there is always an outlet for the water that is pumped out of the sump. For this method, you will need to drill a hole through a floor joist or the foundation from the basement to the outside of the house.

If the direct discharge method is not possible or convenient, the Basement Watchdog pump can be connected to the same line as your main AC sump pump by installing a "Y" connector and two (2) check valves.

In most cases, the backup pump will fit next to the main AC pump in the sump pit. In very narrow pits, the backup pump can be mounted above the main AC pump. Try to fit the backup pump on the floor of the sump first. Make sure there is enough room so that the battery backup pump and the main pump do not touch each other.

Select the installation method that will best suit your needs from the diagrams at the right. Full instructions for each installation method are provided on the following pages.

Installation will take a couple hours.

## NORMAL SUMP PIT INSTALLATIONS

**Installation A**  
Direct Discharge to Outside  
Page 4

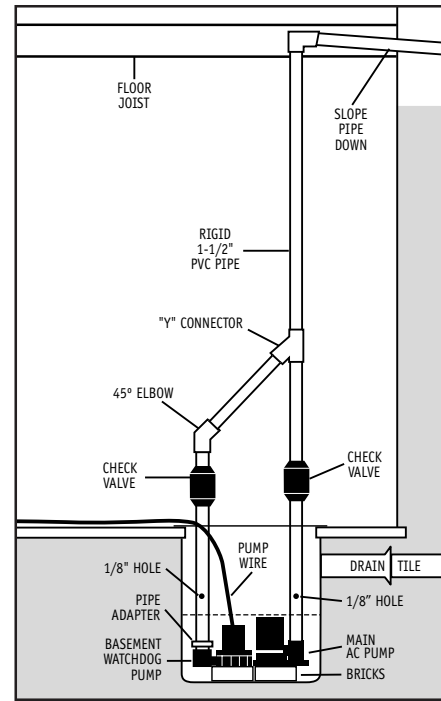
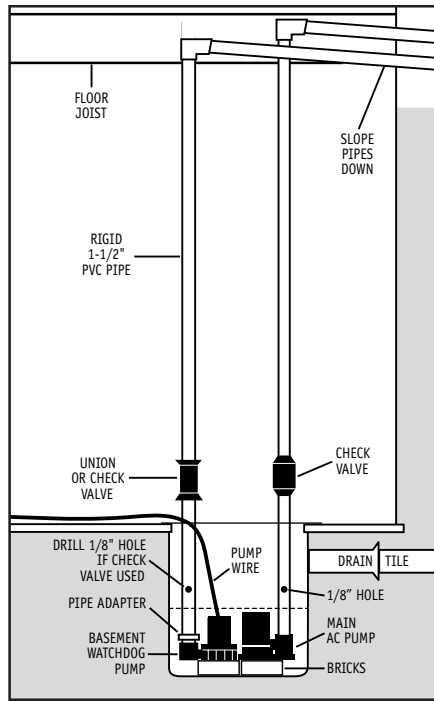

**Installation B**  
Connection to Existing Discharge Pipe  
Page 5

## NARROW SUMP PIT INSTALLATIONS

**Installation C**  
Direct Discharge to Outside  
Page 6

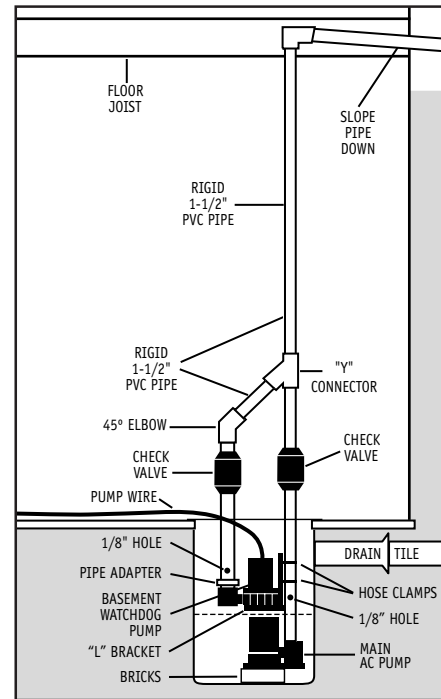
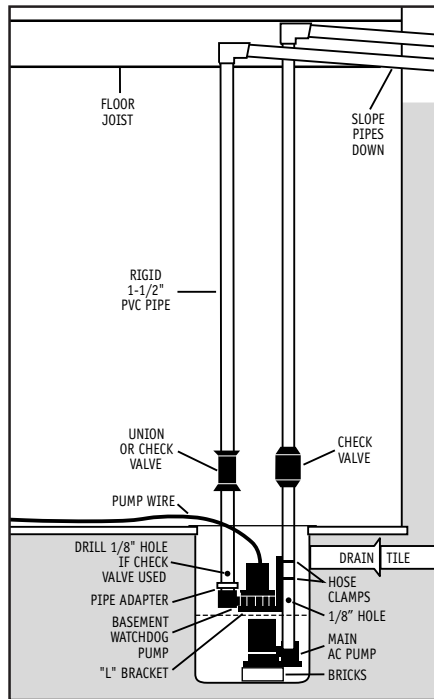

**Installation D**  
Connection to Existing Discharge Pipe  
Page 7

## Pump & Pipe Installation Instructions

### INSTALLATION A: DIRECT DISCHARGE TO THE OUTSIDE OF THE BUILDING (Diagram A)

#### **⚠ DANGER**

Unplug the main AC pump when installing the backup pump to avoid electric shock. Failure to do so could cause serious injury or death.

1. Cut a piece of 1½" rigid PVC pipe long enough to reach from the bottom of the sump pit to one (1) foot above the floor. Prime and cement it to the 1½" pipe adapter, then screw the adapter into the pump.
2. Secure the pump wire so that the plug on the end will not fall into the sump. Attach the wire to the pipe with a piece of tape.
3. Place the pump with the PVC pipe attachment on the bottom of the sump floor next to the main AC pump. *The pumps should not touch each other.* Do not mount the pump to any existing pipes; it should be placed on the



floor of the sump. A brick should be placed under the pump if there are rocks or other debris on the sump floor that may clog the pump.

4. Attach a union or a check valve to the top of the 1½" pipe. This will allow the pump to be removed easily, should the need arise.

The path of the rest of the pipe and the details of each installation will vary. Using sound plumbing practices, route the discharge pipe to an exterior wall via the shortest path with the fewest turns. More turns will reduce the pumping capacity. The pipe section exiting the building should be on a downward slope so that the water in the pipe will exit outside instead of returning to the sump pit. Be sure to seal the hole in the wall where the pipe exits, and prime and cement or clamp all connections securely to prevent leaking. When directly discharging to the outside of the building, no check valve is required. However, a check valve will prevent water from flowing back into the pit when the pump has stopped.

#### **CAUTION**

If you use more than a total of 20 feet of pipe (including vertical and horizontal runs)

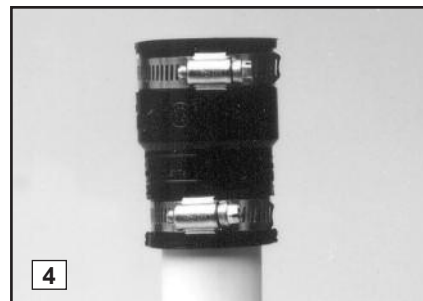

in the installation, install a check valve in place of a union. Make sure it is installed with the arrow pointing up, or it will not prevent the backflow of water. When a check valve is used, a 1/8" hole must be drilled in the PVC pipe above the Basement Watchdog pump. Drill the hole at a 45° angle toward the bottom of the sump to avoid splashing water outside the sump pit. Make sure the hole is above the water line and below the check valve. If a hole is not drilled above the pump, an air lock may prevent the pump from operating.

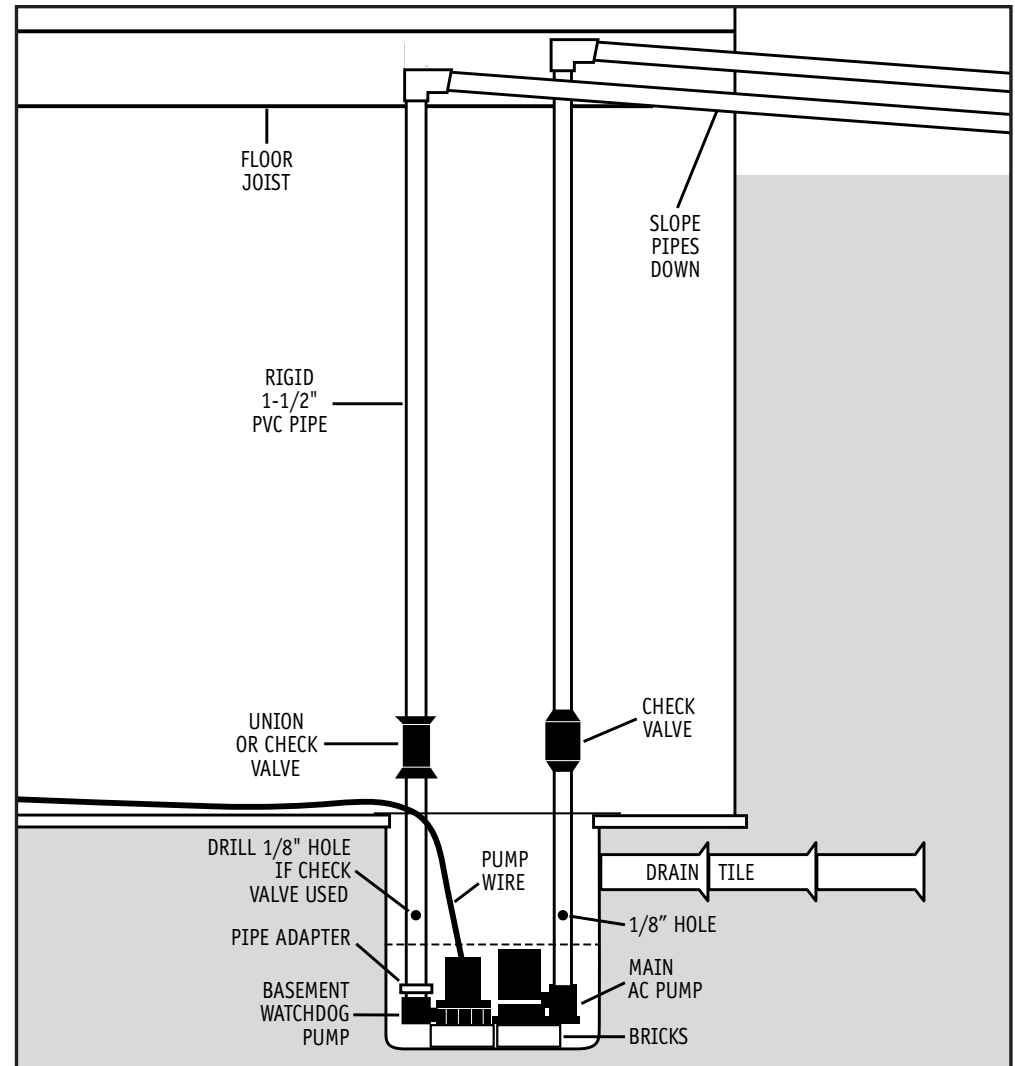
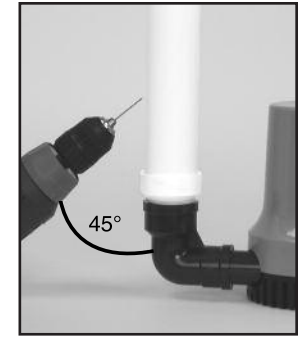
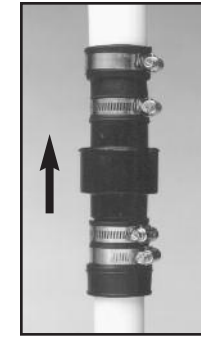

Diagram A

## Pump & Pipe Installation Instructions

### INSTALLATION B: CONNECTION TO AN EXISTING DISCHARGE PIPE (Diagram B)

Depending on your installation requirements, PVC pipe lengths will vary. Cut the pipes and assemble them as shown in photo #7. *Do not cement them together until you are sure they are cut to the correct lengths.* It is important to keep the discharge pipes on both pumps parallel to each other, so that the pumps remain flat on the floor of the sump. More detailed instructions follow.

#### **⚠ DANGER**

**Unplug the main AC pump when installing the backup pump to avoid electric shock. Failure to do so could cause serious injury or death.**

1. Cut a piece of 1½" rigid PVC pipe long enough to reach from the bottom of the sump pit to one (1) foot above the floor. Prime and cement it to the 1½" pipe adapter, then screw the adapter into the pump.
2. Install a check valve on the top of the PVC pipe attached to the Basement Watchdog pump. Make sure it is installed with the arrow pointing up or it will not prevent the backflow of water.

#### **CAUTION**

3. When a check valve is used, a 1/8" hole must be drilled in the PVC pipe above the Basement Watchdog pump. Make sure it is above the water line and below the check valve. Drill the hole at a 45° angle toward the bottom of the sump to avoid splashing

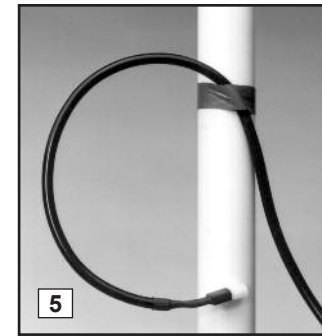
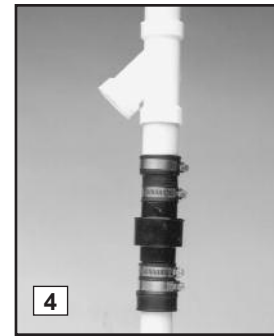
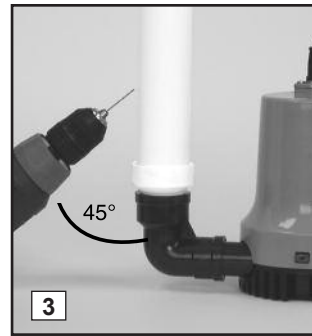
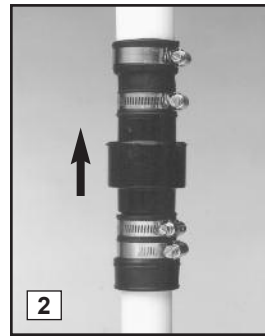

**water outside the sump pit. If a 1/8" hole is not drilled in the pipe above the pump, an air lock may prevent the pump from operating.**

4. If there is no check valve on the discharge pipe of the main AC pump, one must be installed at this time. Cut the discharge pipe approximately one (1) foot above the floor. Install a check valve on the top of the pipe and tighten the bottom hose clamp. Now prime and cement a small piece of 1½" PVC pipe to the bottom of a "Y" connector. Prime and cement the top of the "Y" assembly to the discharge pipe with the "Y" extension facing down toward the backup pump. Now connect the bottom of the assembly to the check valve and tighten the hose clamp.

#### **CAUTION**

**Failure to install a check valve between the "Y" connector and the main AC pump will cause the backup system to not operate properly. A 1/8" hole must also be drilled in the PVC pipe above the main AC pump.**

5. Secure the pump wire so that the plug on the end will not fall into the sump. Attach the wire to the pipe with a piece of tape.
6. Place the pump with the PVC pipe attachment on the bottom of the sump floor next to the main AC pump. *The pumps should not touch each other.* Do not mount the pump to any existing pipes; it should be placed on the floor of the sump. A brick should be placed under the pump if there are rocks or other debris on the sump floor that may clog the pump.

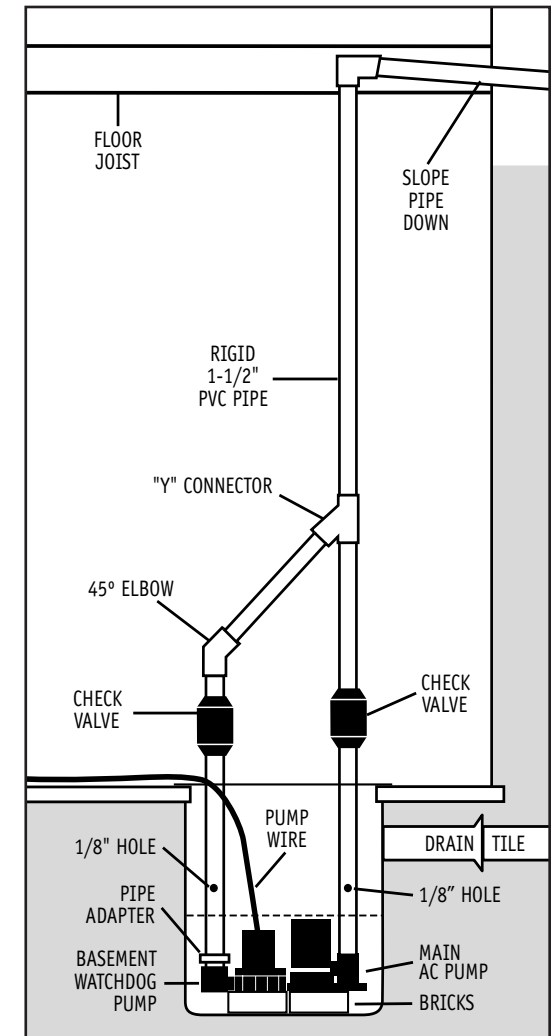

Diagram B

## Pump & Pipe Installation Instructions

**INSTALLATION C:  
DIRECT DISCHARGE TO THE OUTSIDE OF THE  
BUILDING FOR NARROW SUMP PITS  
(Diagram C)**

### **⚠ DANGER**

**Unplug the main AC pump when installing the backup pump to avoid electric shock. Failure to do so could cause serious injury or death.**

1. Attach an "L" bracket to the discharge pipe of the main AC pump with two (2) stainless steel hose clamps. Position the bracket so the bottom of the "L" is just above the top of the main pump, and out of the way of any float switch on the main pump.
2. (a) Remove the black bottom strainer of the pump by pressing in the two tabs on the strainer and pushing down. There are holes suitable for mounting on the bottom of the strainer. (b) Using the #8-32 x 3/4" stainless steel screw, washer and nut, attach the strainer to the "L" bracket. (c) Once the strainer is

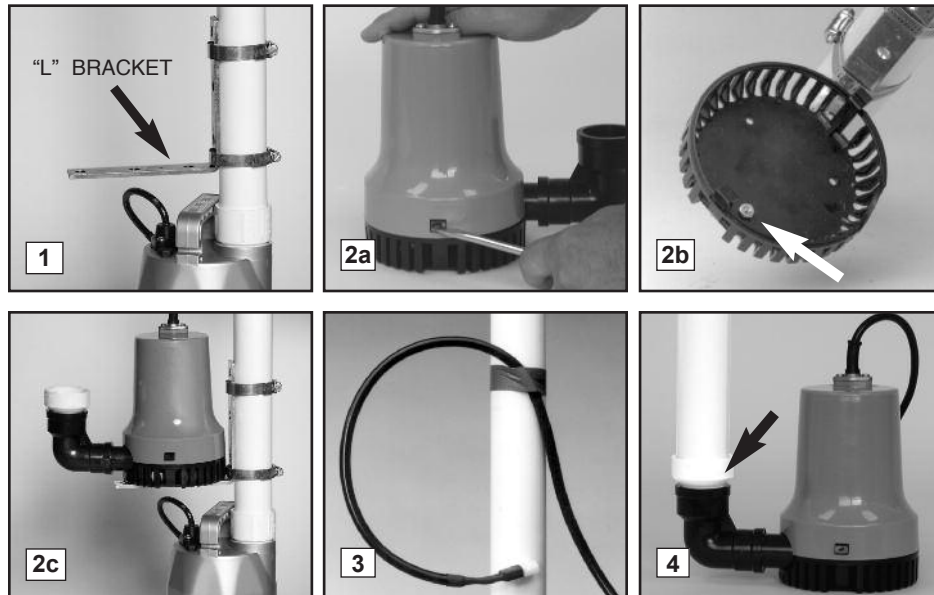

attached, simply press the rest of the pump onto the mounted strainer.

3. Secure the pump wire so that the plug on the end will not fall into the sump. Attach the wire to the pipe with a piece of tape.
4. Cut a piece of 1½" rigid PVC pipe long enough to reach from the elbow of the backup pump to one (1) foot above the floor. Prime and cement it to the 1½" pipe adapter, then screw the adapter into the pump.
5. Attach a union or check valve to the top of the 1½" PVC pipe. This will allow the pump to be removed easily, should the need arise.

The path of the rest of the pipe and the details of each installation will vary. Using sound plumbing practices, route the discharge pipe to an exterior wall via the shortest path with the fewest turns. More turns will reduce the pumping capacity. The pipe section exiting the building should be on a downward slope so that the water in the pipe will exit outside instead of returning to the sump pit. Be sure to seal the hole in the wall where the pipe exits, and prime and cement or clamp all connections securely to prevent leaking. When directly discharging to the outside of the building, no check valve is required. However, a check valve will prevent

water from flowing back into the pit when the pump has stopped.

### **CAUTION**

**If you use more than a total of 20 feet of pipe (including vertical and horizontal runs) in the installation, install a check valve in place of a union. Make sure it is installed with the arrow pointing up or it will not prevent the**

**backflow of water. When a check valve is used, a 1/8" hole must be drilled in the PVC pipe above the Basement Watchdog pump. Drill the hole at a 45° angle toward the bottom of the sump to avoid splashing water outside the sump pit. Make sure the hole is above the water line, and below the check valve. If a hole is not drilled above the pump, an air lock may prevent the pump from operating.**

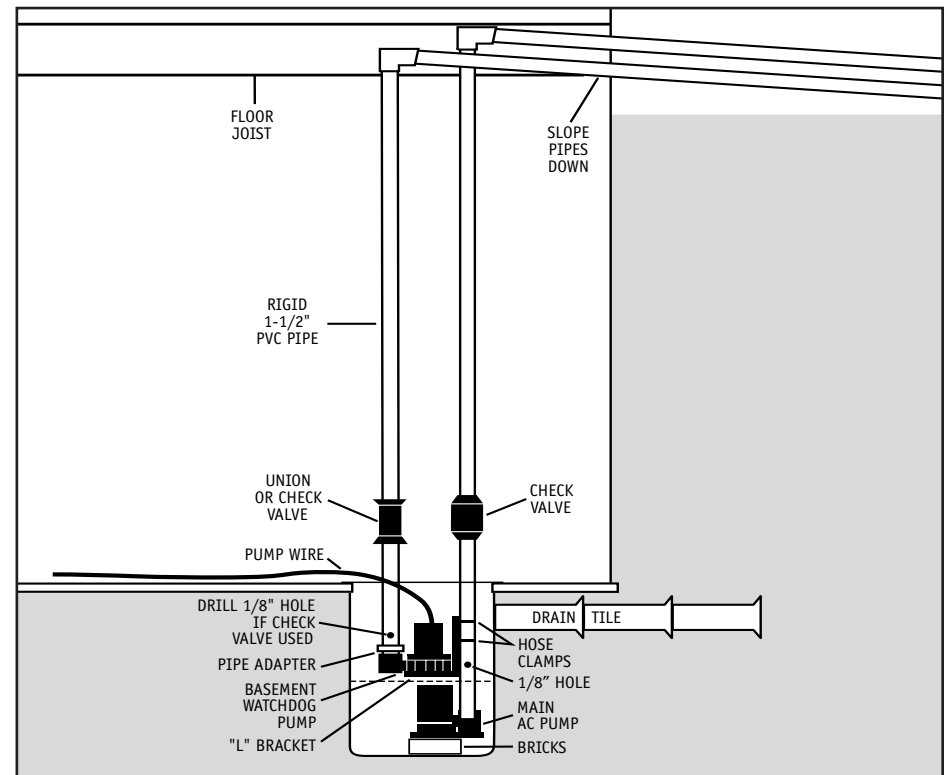
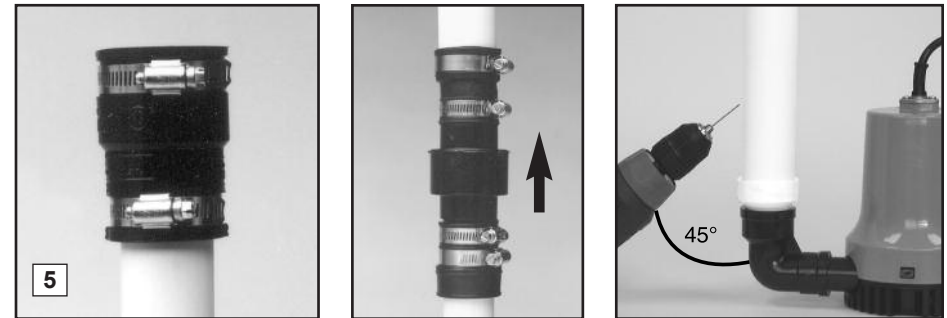

**Diagram C**

# Pump & Pipe Installation Instructions

## INSTALLATION D: CONNECTION TO EXISTING DISCHARGE PIPE FOR NARROW SUMP PITS (Diagram D)

Depending on your installation requirements, PVC pipe lengths will vary. Cut the pipes and assemble them as shown in photo #8. Do not cement them together until you are sure they are cut to the correct lengths. It is important to keep the discharge pipes on both pumps parallel to each other, so that the pumps remain flat on the floor of the sump. More detailed instructions follow.

### **⚠ DANGER**

**Unplug the main AC pump when installing the backup pump to avoid electric shock. Failure to do so could cause serious injury or death.**

1. Attach an "L" bracket to the discharge pipe of the main AC pump with two (2) stainless steel

hose clamps. Position the bracket so the bottom of the "L" is just above the top of the main pump, and out of the way of any float switch on the main pump.

2. (a) Remove the black bottom strainer of the pump by pressing in the two tabs on the strainer and pushing down. There are holes suitable for mounting on the bottom of the strainer. (b) Using the #8-32 x 3/4" stainless screw, washer and nut, attach the strainer to the "L" bracket. (c) Once the strainer is attached, simply press the rest of the pump onto the mounted strainer.
3. Secure the pump wire so that the plug on the end will not fall into the sump. Attach the wire to the pipe with a piece of tape.
4. Cut a piece of 1 1/2" rigid PVC pipe long enough to reach from the elbow of the backup pump to one (1) foot above the floor. Prime and cement it to the 1 1/2" pipe adapter, then screw the adapter into the pump.
5. Install a check valve on the top of the PVC pipe

attached to the Basement Watchdog pump. Make sure it is installed with the arrow pointing up or it will not prevent the backflow of water.

### **CAUTION**

6. When a check valve is used, a 1/8" hole must be drilled in the PVC pipe above the Basement Watchdog pump. Make sure it is above the water line and below the check valve. Drill the hole at a 45° angle toward the bottom of the sump to avoid splashing water outside the sump pit. If a 1/8" hole is not drilled above the pump, an air lock may prevent the pump from operating.
7. If there is no check valve on the main AC pump discharge pipe, one must be installed at this time. Cut the discharge pipe approximately one (1) foot above the floor. Install a check valve on the top of the pipe and tighten the bottom hose clamp. Now prime and cement a small piece of 1 1/2" PVC pipe to the bottom of a "Y" connector. Prime and cement the top of the "Y" assembly to the discharge pipe with the "Y" extension facing

down toward the backup pump. Now connect the bottom of the assembly to the check valve and tighten the hose clamp.

### **CAUTION**

**Failure to install a check valve between the "Y" connector and the main AC pump will cause the backup system to not operate properly. A 1/8" hole must also be drilled in the PVC pipe above the main AC pump.**

8. Connect a piece of 1 1/2" PVC pipe above the check valve of the Basement Watchdog pump, and attach a 45° elbow to that pipe. Extend another piece of pipe to reach from the 45° elbow to the "Y" connector on the other pipe.
9. Prime and cement all pipe connections securely to prevent leaking, and tighten all the hose clamps.

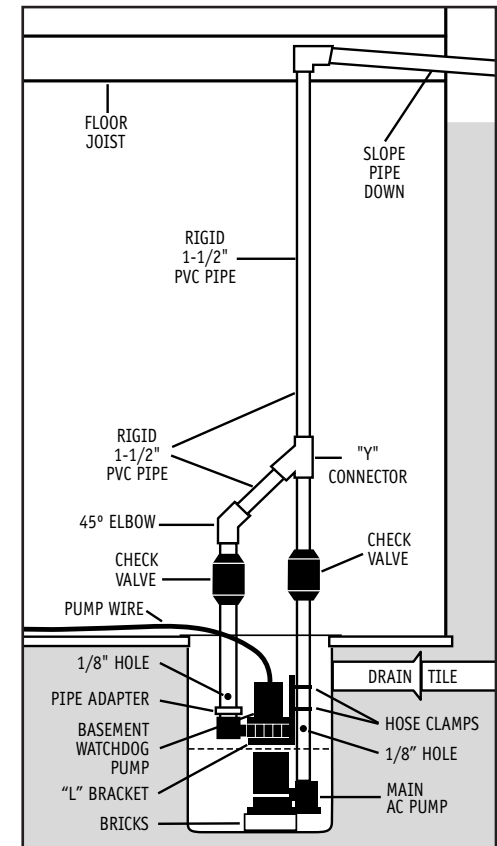
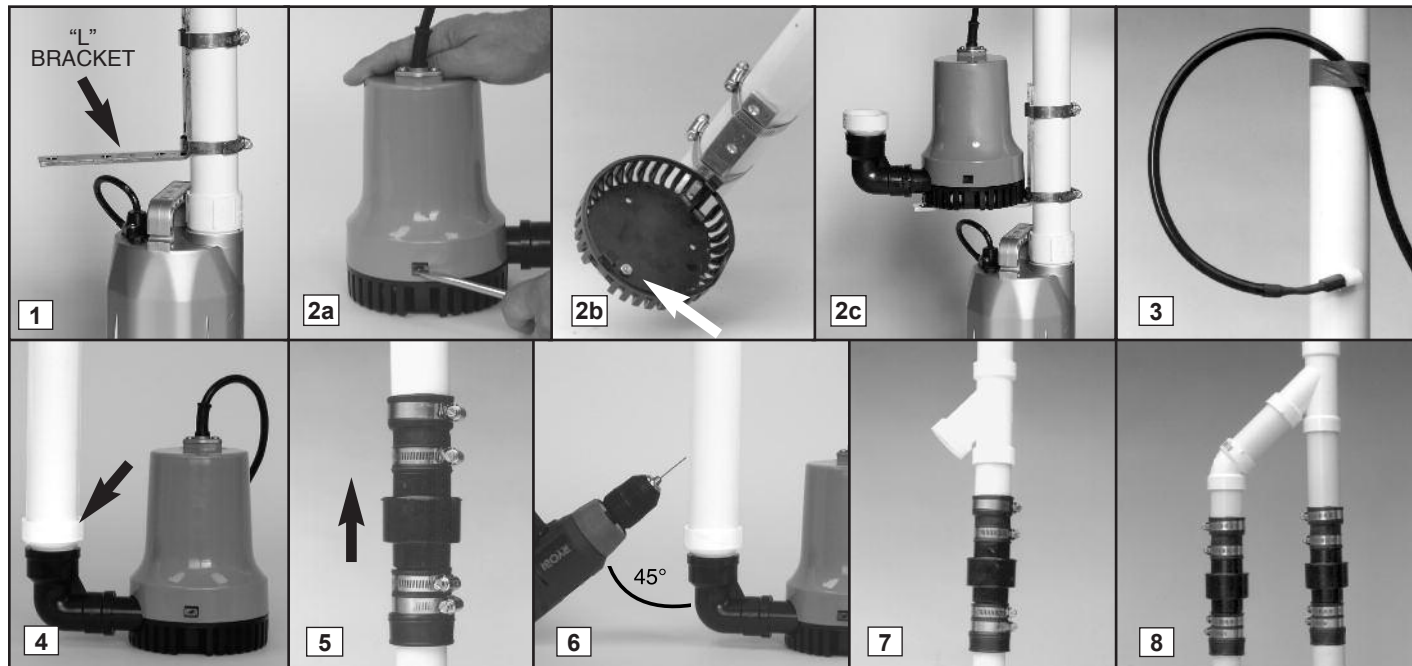

Diagram D



## Battery Instructions

The Basement Watchdog Big Standby battery has been designed to run this system for 50 hours, based on a 10% duty cycle. However, most of the time the pump will turn on and off, and this battery will run the pump intermittently for days. To increase the running time of this system, two batteries can be connected together. The batteries must be of same age, type and capacity. Connecting an old and new battery together will not charge properly. Specific connection instructions will be explained below. In addition, the unique materials in the Basement Watchdog Standby batteries enable them to last longer in standby service.

### CAUTION

- The use of automotive batteries is NOT recommended. Automotive batteries are not designed for this application. They will only run the pump for a short time and will have a shorter life than a standby battery.
- The battery fluid sensor is designed to fit the Basement Watchdog Standby batteries. Measuring the battery fluid is one of the most important features of the system, since about 80% of backup sump pump failures are the result of a battery that has dried out.
- The internal construction of some wet cell batteries may not be compatible with this system. Glentronics can not guarantee the compatibility of other brands of batteries. The use of a Basement Watchdog battery is **HIGHLY** recommended.

### ⚠ DANGER

**DO NOT** insert the fluid sensor into any battery except a Basement Watchdog battery. **DO NOT** drill a hole in another brand of battery to accommodate the fluid sensor. **DO NOT** use the enclosed battery cap on any battery except a Basement Watchdog battery. **DO NOT** drill a hole in the cap of another brand of battery to accommodate the fluid sensor. Batteries emit explosive gases, which can cause serious injury or death.

## PREPARING THE BASEMENT WATCHDOG STANDBY BATTERY

The Basement Watchdog Standby batteries are shipped dry (without acid) so they never lose power before you take them home. A battery is activated when the acid is added, and then it slowly begins to deteriorate as it ages. By adding the acid just before use, the battery will always be fresh. Use 1.265 specific gravity battery acid to fill the battery. It is available where you purchased the battery.

*NOTE: Basement Watchdog batteries now come in two configurations. The tops of the batteries look different, and the directions for filling the batteries and connecting the fluid sensor will vary slightly. If the top of your battery looks like photo A, follow the instructions on this page. If the top of your battery looks like photo B on page 9, follow the instructions on page 9.*

### ⚠ DANGER/POISON

Contains sulfuric acid. Wear eye and clothing protection. If battery acid contacts skin or clothing, wash immediately with soap and water. If acid enters eyes, flush with water for 15 minutes, and get prompt medical attention. Review the safety instructions on page 1.

## TO FILL THE BATTERY

1. Remove the cover of the battery box by pushing in the tabs on the front and back of the box and lifting up.
2. Place the battery box on the floor. Place the dry (unfilled) battery into the battery box. Remove the foil seal on the top of the battery.
3. Carefully push in the perforated tab at the top of the acid pack. Lift up the large tab and pull out the dispensing hose. Hold the hose upright above the pack and squeeze the hose forcing all the acid back into the pack.
4. Position the acid pack and battery as shown at the right. Pinch the end of the hose together and cut off the tip. Insert the end of the hose into each cell. Control the flow by pinching

the hose with thumb and forefinger. **Fill each cell of the battery to a level just covering the battery plates, and then go back and top off each cell equally. It is important to have all the cells filled equally or the battery will not operate properly.** The acid should reach a level about ¼" below the cap ring as shown in the diagram at right. **DO NOT OVERFILL THE BATTERY.** (Diagram E)

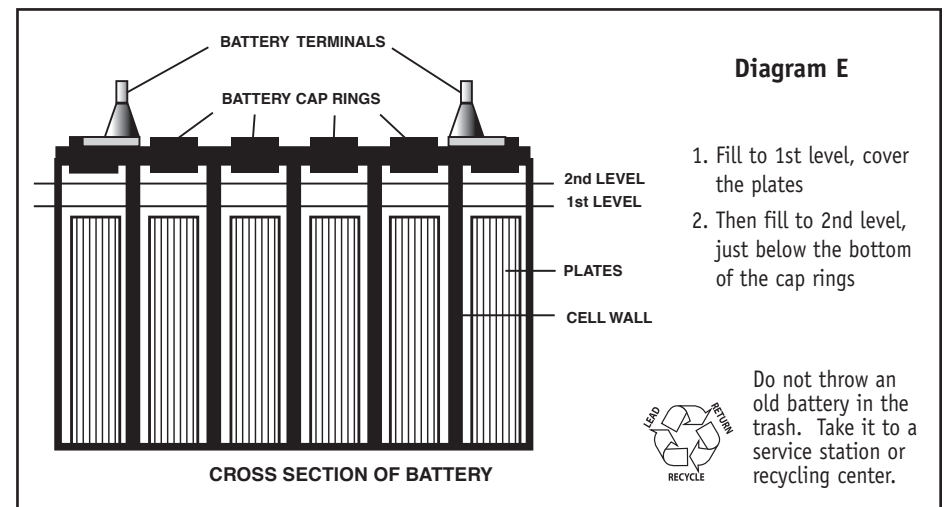
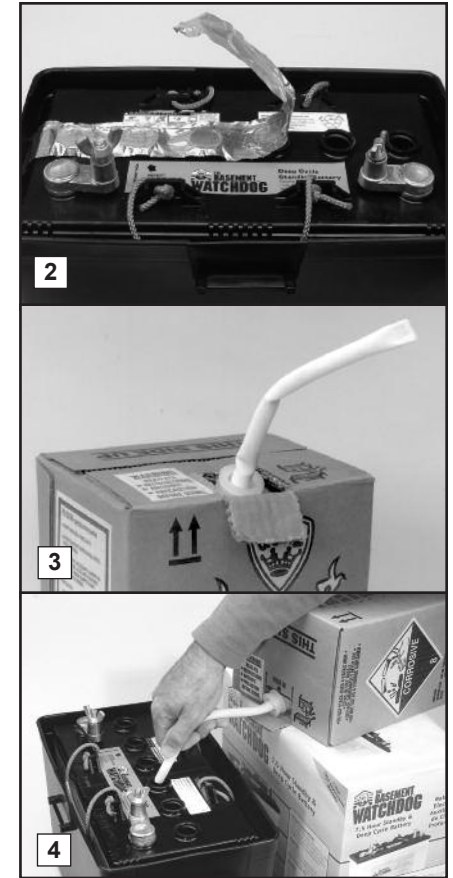
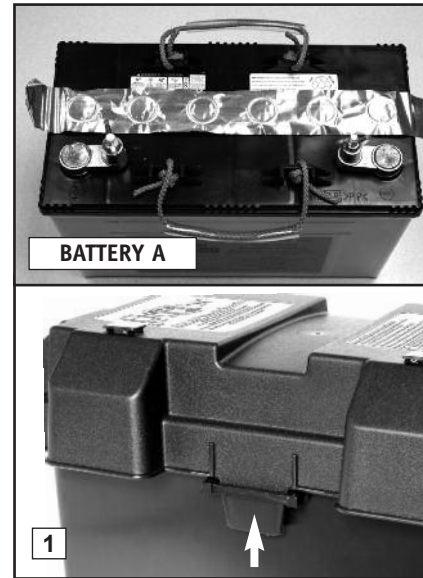

A newly filled battery will sometimes require additional acid after about 20 minutes. Re-examine the fill level, and add additional acid if necessary. The battery acid may bubble at this time and give off a sulfur-like smell, but this is normal. You may top off each cell with a little distilled water, if needed. After the battery has been filled, screw the six (6) caps securely on the top of the battery.

The battery will be charged 70%-80% 30 minutes after adding the acid. The system will then finish charging the battery. During this time the alarm may sound.

### CAUTION

**When you fill the battery for the FIRST time, it will be the ONLY time you add acid to the battery. In the future, when the fluid level is low, add distilled water to the cells. NEVER add more acid.**



If your battery looks like the battery above, follow these instructions:

1. Remove the cover of the battery box by pushing in the tabs on the front and back of the box and lifting up.
2. Place the battery box on the floor. Place the dry (unfilled) battery into the battery box. Remove the two battery caps by carefully prying them up with a screwdriver as shown

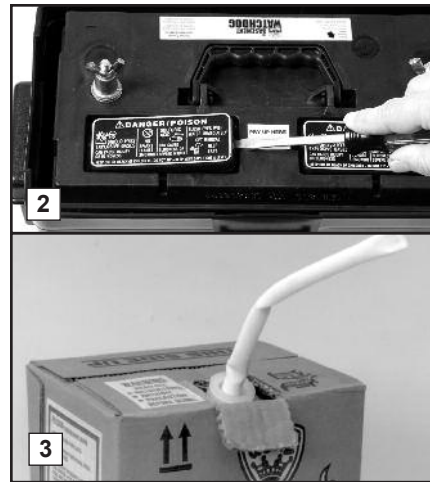
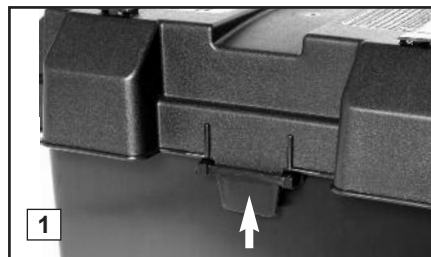

on the right. Place the screwdriver in the middle of the cap on the top of the battery. DO NOT lift the cap by prying it up from the groove on the back of the battery cap. It may damage the vent.

3. Carefully push in the perforated tab at the top of the acid pack. Lift up the large tab and pull out the dispensing hose. Hold the hose upright above the pack and squeeze the hose forcing all the acid back into the pack.
4. Position the acid pack and battery as shown at the right. Pinch the end of the hose together and cut off the tip. Insert the end of the hose into each cell. Control the flow by pinching the hose with thumb and forefinger. **Fill each cell of the battery to a level just covering**

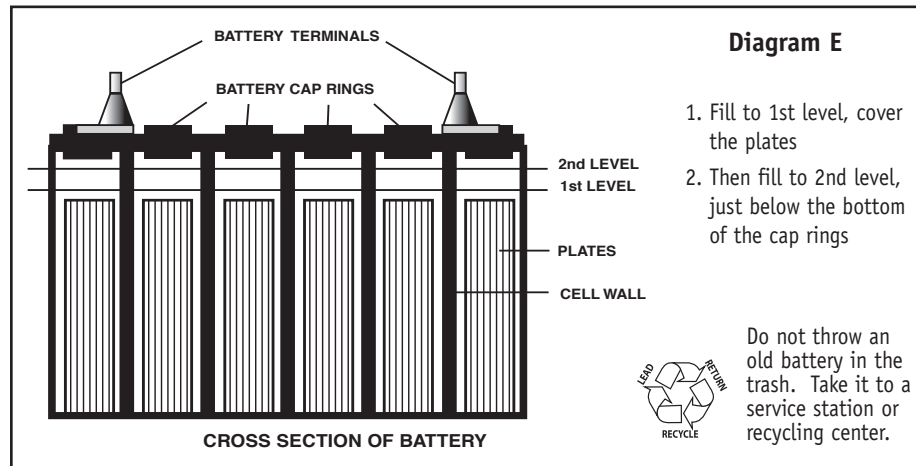

**the battery plates, and then go back and top off each cell equally. It is important to have all the cells filled equally or the battery will not operate properly.** The acid should reach a level about 1/4" below the cap ring as shown in the diagram at right. DO NOT OVERFILL THE BATTERY. (Diagram E)

A newly filled battery will sometimes require additional acid after about 20 minutes. Re-examine the fill level, and add additional acid if necessary. The battery acid may bubble at this time and give off a sulfur-like smell, but this is normal. You may top off each cell with a little distilled water, if needed. After the battery has been filled, press the caps securely on the top of the battery.

The battery will be charged 70%-80% 30 minutes after adding the acid. The system will then finish charging the battery. During this time the alarm may sound.

### CAUTION

**When you fill the battery for the FIRST time, it will be the ONLY time you add acid to the battery. In the future, when the fluid level**

**is low, add distilled water to the cells. NEVER add more acid.**

## Battery Maintenance

Measuring the battery fluid level is one of the most important features of the system. It is important to check the battery fluid levels at least once every 4-6 months. Detailed instructions on adding distilled water to the battery can be found within the **Understanding the Warnings & Alarms** section of this manual (page 11, ① - **Battery fluid low**). If you are not using a Basement Watchdog standby battery, you cannot use the battery fluid sensor. You will need to attach the fluid sensor to the POSITIVE (+) post of the battery or the alarm will sound continuously. The Basement Watchdog sump pump system will NOT warn you if the fluid level is low in this configuration. You will need to check your battery every couple of months to see if it needs water. If the battery dries out, the system will not work. If you are using a maintenance free battery or sealed AGM battery you will also need to attach the fluid sensor to the POSITIVE (+) post of the battery or the alarm will sound continuously.

## Control Unit Connections

### ⚠ DANGER

**Risk of electrical shock or battery explosion, which can cause serious injury or death. Unplug the main AC pump to avoid electrical shock. Wear eye protection. Work in a well-ventilated area. Do not smoke or allow a spark or flame in the vicinity of the battery. Avoid dropping metal tools on the battery. If battery acid contacts eyes, flush with water for 15 minutes and get prompt medical attention. Review the safety instructions on page 1.**

Position the control unit in a secure place approximately four (4) feet above the floor. Be sure the power cord will reach the AC power outlet, and the pump and the float switch will reach the bottom of the sump pit. Position the unit in a well-ventilated area. Do not place anything on top of the battery. Do not place anything on top of the control unit. (Diagram F)

1. **Positioning the dual float switch:** The float switch will turn on the pump when the water raises either float, and it will remain running



as long as the water is above the float. When the water drops below the float switch, an internal timer in the control unit will keep the pump running an additional 25 seconds to empty the sump pit. The switch should be mounted about six (6) inches above the water level line in the sump pit. Attach the float switch very securely to the discharge pipe with the plastic wire tie. *Be sure the switch is positioned vertically with the mounting bracket at the top. Do not tilt the switch. Do not position the float switch on the side of the discharge pipe facing the drain tile or any incoming rush of water!*

**2. Connecting the pump:** Remove the security tag from the pump and plug the pump wires into the pump connector on the back of the control unit. Keep the backup pump wire, the AC pump wire, and the float wire separate from each other. Do not let them cross on the

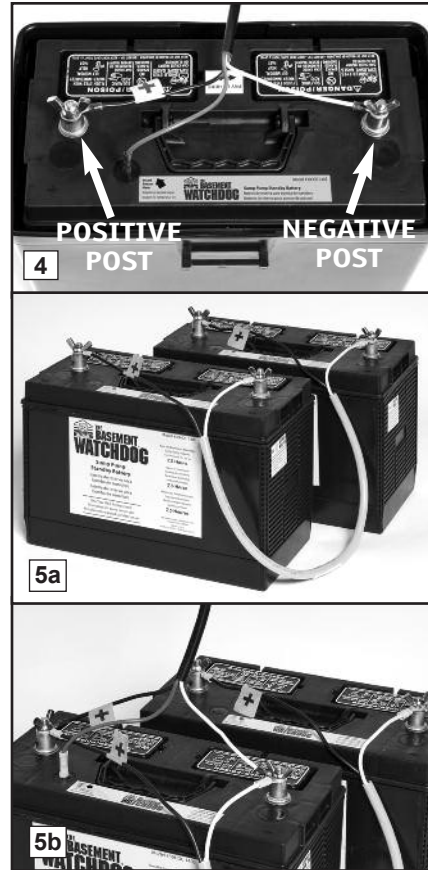

final installation.

**3. Installing the battery fluid sensor:** BASEMENT WATCHDOG BATTERIES COME IN TWO CONFIGURATIONS. THE HOLE FOR THE FLUID SENSOR IS MARKED BY AN ARROW ON THE TOP OF EACH BATTERY. Remove the cover of the battery box by pushing in the tabs on the front and back, then lifting up. Fan the area around the top of the battery with a piece of cardboard (or another non-metallic material) to remove any hydrogen or oxygen gas that may have been emitted from the battery. (a) If the top of the battery has six small battery caps, replace the battery cap that is 2nd from the POSITIVE (+) post with the battery cap that is provided in the Basement Watchdog package. An arrow on the top of the battery marks this position. There are two holes in this battery cap. Insert the fluid sensor in the hole that is off-center on

the top of the cap. Do not glue the sensor into the cap. (b) If the top of the battery has two large caps, place the fluid sensor in the hole molded on the top of the battery. It is located in the second cell from the positive post, and the location is marked by an arrow on the top label. Hold the sensor straight and press it firmly into the hole. Do not bend the sensor.

**CAUTION**

If you are not using a Basement Watchdog Standby battery or if you are using a maintenance free (AGM) battery, you cannot use the battery fluid sensor. However, you must attach the sensor to the POSITIVE (+) post of the battery or the alarm will sound continuously. The Basement Watchdog sump pump system will

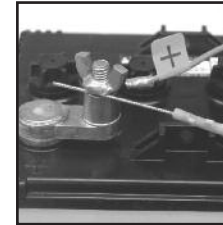

not warn you if the fluid level is low in this configuration. You will need to check your battery every couple of months to see if it needs water. If the battery dries out, the system will not work.

**4. Connecting the battery:** Remove the wing nuts from the battery terminals. Remove the security tag from the battery cables. Attach the battery cables to the battery...the WHITE wire to the NEGATIVE (-) post, and the BLACK wire to the POSITIVE (+) post. Replace the wing nuts and tighten them. **DO NOT** apply corrosion resisting sprays or pads to the terminal rings or posts, since this could prevent the battery from charging properly. Be sure to slide the switch on the front of the controller to the type of battery used with the system (maintenance free or non-maintenance free battery).

**5. Connecting two batteries:** If you are connecting two batteries to the system, before you replace the wing nuts, connect the

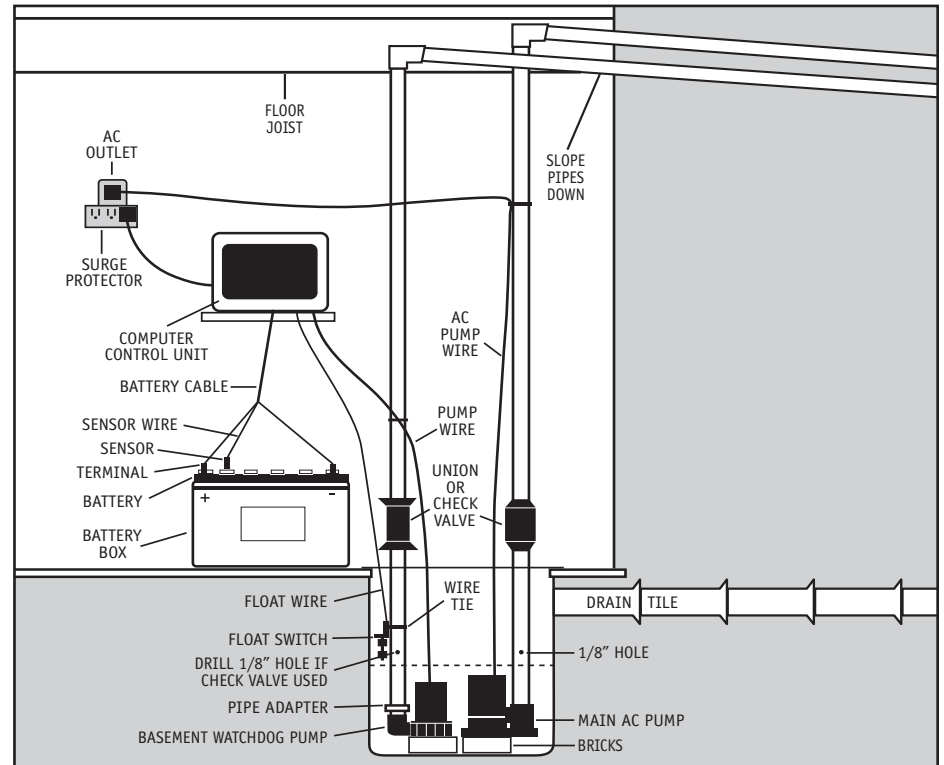

Diagram F

additional cable to the two batteries....the BLACK wires to the POSITIVE (+) posts and the WHITE wires to the NEGATIVE (-) posts of each battery. **NEVER** attach one end of the positive wire to the positive post and the other end of the positive wire to the negative post on the other battery.

6. Immediately plug the AC power cord into a grounded AC wall outlet. (A surge protector that protects all three pins on the power plug is recommended.)



You will have 10 seconds before the "Power failure" alarm will sound. The alarm will be silenced once the unit is plugged into the wall. At this time the computer control unit will perform a startup procedure and the percentage lights will cycle from 25% to 100%.

7. Secure the cover on the battery box by slipping the tabs through the fittings on the front and back of the box.

8. For a neater installation, secure the cables from the controllers to the discharge pipe in a couple places. Make sure the wires are not touching each other or overlapping each other.



9. **BE SURE TO PLUG IN THE MAIN AC PUMP WHEN YOU FINISH THE INSTALLATION.**

## Understanding the Warnings & Alarms

The Basement Watchdog control unit features a series of warning lights that pinpoint potential problems. In addition, an alarm sounds to alert

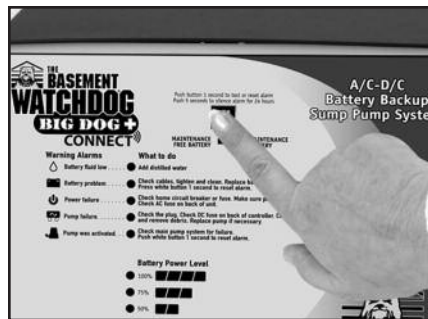

you to the problem. In some cases the lights and alarm will go off automatically when the problem has been solved. In others, the BLUE button must be pushed to silence the alarm. Refer to the table below for a quick review of the features and their corresponding alarm status.

### SILENCING THE ALARM DURING AN EMERGENCY

If the alarm can be silenced before the problem is corrected, you may silence it for two (2) minutes by holding down the BLUE button for one (1) second. The alarm will be silenced, but the light will stay on. To silence the alarm for 24 hours, hold down the BLUE button for five (5) seconds. It will automatically reset itself after 24 hours. The warning light will stay on.

#### ① Battery fluid low

#### **⚠ DANGER**

**Risk of electrical shock or battery explosion, which can cause serious injury or death. Wear eye protection. Work in a well-ventilated area. Do not smoke or allow a spark or flame**

Warning	Light	Alarm	Alarm can be silenced before problem is corrected	Alarm shuts off automatically when the problem is corrected
Battery fluid low	Yes	Yes	Yes	Yes
Battery problem	Yes	Yes	No	No, push BLUE button
Power failure	Yes	Yes	Yes	Yes
Pump failure	Yes	Yes	No	No, push BLUE button
Pump was activated	Yes	Yes	Yes	No, push BLUE button

## A/C-D/C Battery Backup Sump Pump System

Push button 1 second to test or reset alarm  
Push 5 seconds to silence alarm for 24 hours

**PUSH TO TEST OR RESET**

MAINTENANCE FREE BATTERY    NON-MAINTENANCE FREE BATTERY

#### Warning Alarms

- ① Battery fluid low
- ② Battery problem
- ③ Power failure
- ④ Pump failure
- ⑤ Pump was activated

#### What to do

- Add distilled water
- Check cables, tighten and clean. Replace battery, if necessary. Press white button 1 second to reset alarm.
- Check home circuit breaker or fuse. Make sure power plug is in wall outlet. Check AC fuse on back of unit.
- Check the plug. Check DC fuse on back of controller. Check pump for blockage and remove debris. Replace pump if necessary.
- Check main pump system for failure. Push white button 1 second to reset alarm.

#### ⑥ Battery Power Level

- 100%
- 75%
- 50%
- 25%

[www.BasementWatchdog.com](http://www.BasementWatchdog.com)

*The Basement Watchdog... Watching Out for You!*

in the vicinity of the battery. Avoid dropping metal tools on the battery. If battery acid contacts eyes, flush with water for 15 minutes and get prompt medical attention. Review the safety instructions on page 1.

REFER TO THE PHOTOS ON PAGE 12

If this warning light and alarm are on, you need to add distilled water to the battery.

1. Unplug the control unit power cord from the wall outlet.
2. Remove the cover of the battery box by

pushing in the tabs on the front and back, then lifting up.

3. Fan the area around the top of the battery with a piece of cardboard (or another non-metallic material) to remove any hydrogen or oxygen gas that may have been emitted from the battery.
4. Unscrew the wing nuts and remove the battery cables. Then remove the fluid sensor from the battery.
5. Remove the battery caps. Add distilled water to each cell. If distilled water is not available, tap water with a low mineral content may be used. Well water is not recommended. **NEVER ADD MORE ACID.** Fill the battery to level 2 as shown in Diagram E on page 8. (The Basement Watchdog battery filler will automatically fill the level to the correct height. See enclosed order form.)
6. Replace the battery caps. Replace the fluid sensor in the hole on the top of the battery or in the yellow cap, depending on which battery you own. Be sure the fluid sensor is positioned in the 2nd cell from the positive

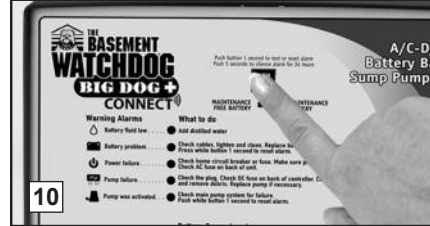
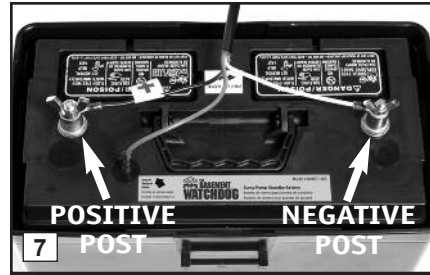
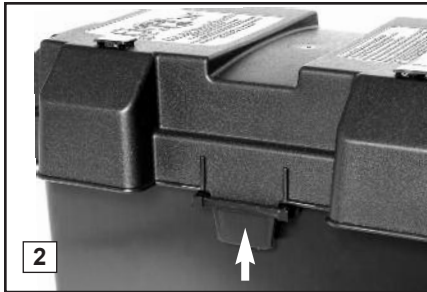

post. The hole is marked with an arrow.

7. Replace the battery cables...the WHITE wire to the NEGATIVE (-) post, and the BLACK wire to the POSITIVE (+) post. Replace the wing nuts and tighten.

8. Replace the cover of the battery box.

9. Plug the controller back into the outlet. (You should provide additional protection for the control unit by using a surge protector.)

10. If any of the alarms are sounding, press the BLUE button on the front of the control panel for one (1) second.

## ② Battery problem

This light and alarm will come on when the control unit detects there is less than one (1) hour of pumping power left in the battery, or that the battery is damaged. The alarm cannot be silenced, because action needs to be taken to protect your basement. If your battery is more than five (5) years old, replace it. If not, here are several situations that would cause the pump to run the battery for an extended time and discharge the battery: Check the list below before you replace the battery.

- If the 3rd light on the controller is also on, it means that the unit is not receiving AC power. Either the AC power is out, the circuit breaker or AC fuse has blown, or the outlet is bad. When the problem is

corrected, the battery should recharge.

- If no other lights are on, this means the terminals may be corroded, and the battery cannot charge properly. Unplug the charger from the wall outlet. Then, check the battery cables and the battery terminals for corrosion. Clean and tighten them as needed. The procedure is described in the next column.
- If the battery terminals have been cleaned and the light is still on, there could be a problem with the controller or the battery. The best way to determine if the battery is the problem is to have it charged and load tested at any local car service station. If the battery is bad and less than one (1) year old, it can be returned to the place of purchase for a replacement (receipt required). If the battery is good, contact Glentronics' service department for further instructions. The phone number is 800-991-0466, option #3.

If the battery alarm goes on while the pump is running and the power is out, you will have a minimum of one (1) hour of continuous pumping time to replace the battery. (In most cases, the pump does not run continuously, and therefore, you actually have a longer time to replace it.) You will not be able to silence the alarm. Left unattended, the basement will flood. In a severe emergency, if a replacement battery is not available, you could temporarily use your car battery, or recharge this battery by connecting it to your car battery.

Once the AC power is restored, the battery will recharge automatically, unless it is old or damaged. The alarm will remain on until the BLUE button is pressed for one (1) second.

In the event that your Basement Watchdog sump pump system has pumped for an extended period of time, the battery may be very depleted. In this condition, when the AC power is returned to the unit, a battery alarm will continue to sound. The battery may need a longer period to recharge. Press the BLUE button for five (5) seconds to silence the alarm.

If the battery is completely discharged, an

internal safety feature will not allow the charging system to activate. Call the Glentronics service department for instructions or replace the battery.

## TO CLEAN THE BATTERY TERMINALS AND CABLES

### ⚠ DANGER

**Risk of electrical shock or battery explosion, which can cause serious injury or death. Wear eye protection. Work in a well-ventilated area. Do not smoke or allow a spark or flame in the vicinity of the battery. Avoid dropping metal tools on the battery. If battery acid contacts eyes, flush with water for 15 minutes and get prompt medical attention. Review the safety instructions on page 1.**

1. Unplug the power cord from the wall outlet.
2. Remove the cover of the battery box by pushing in the tabs on the front and back, then lifting up.
3. Fan the area around the top of the battery with a piece of cardboard (or another non-metallic material) to remove any hydrogen or oxygen gas that may have been emitted from the battery.



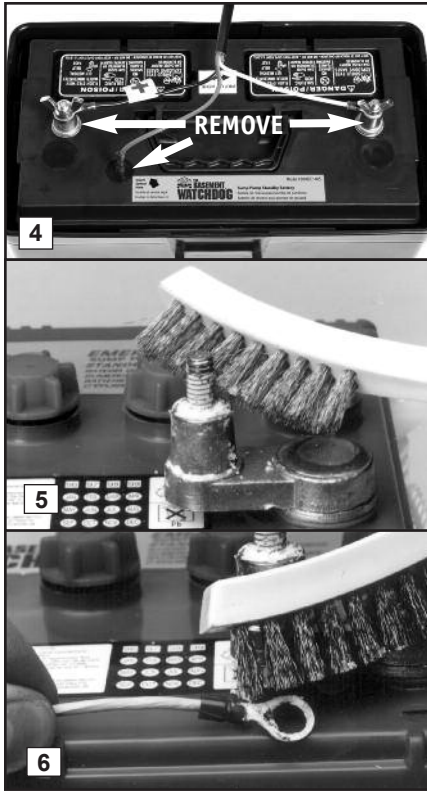

4. Remove the fluid sensor from the top of the battery. Unscrew the wing nuts and remove the battery cables.

5. Clean the battery posts with a battery post terminal cleaner or a wire brush.

6. Clean any corrosion off of the ring connectors on the ends of the battery wires. Use a stiff brush or sandpaper. **DO NOT** apply corrosion resisting sprays or pads to the terminal rings or posts after you have cleaned them, since this could prevent the battery from charging properly.

7. Replace the fluid sensor in the hole on the top of the battery or in the yellow cap, depending on which battery you own. Be sure the fluid sensor is positioned in the 2nd cell from the positive post. The hole is marked with an arrow. Do not bend the sensor rod. If you are using a maintenance-free battery, attach the

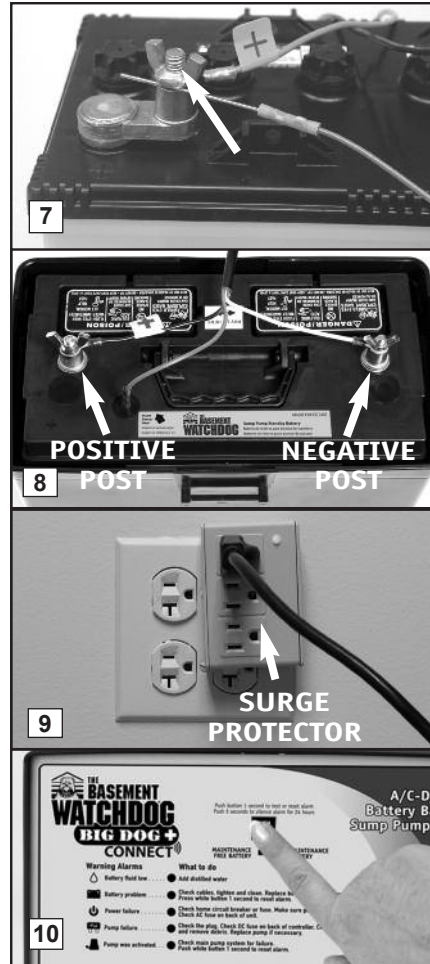

fluid sensor to the POSITIVE (+) post of the battery and slide the switch on the front of the controller to "Maintenance Free Battery"

8. Then replace the battery cables, WHITE to the NEGATIVE (-) post and BLACK to the POSITIVE (+) post. Tighten the wing nuts. Replace the cover of the battery box.

9. Plug the power cord back into the wall outlet. (You should provide additional protection for the control unit by using a surge protector.)

10. If any of the alarms are sounding, press the BLUE button on the front of the control panel for one (1) second.

## REPLACING THE BATTERY

### **⚠ DANGER**

Risk of electrical shock or battery explosion, which can cause serious injury or death. Wear eye protection. Work in a well-ventilated area. Do not smoke or allow a spark or flame in the vicinity of the battery. Avoid dropping metal tools on the battery. If battery acid contacts eyes, flush with water for 15 minutes and get prompt medical attention. Review the safety instructions on page 1.

### REFER TO THE PHOTOS BELOW

1. Unplug the power cord from the wall outlet.
2. Remove the cover of the battery box by pushing in the tabs on the front and back, then lifting up.

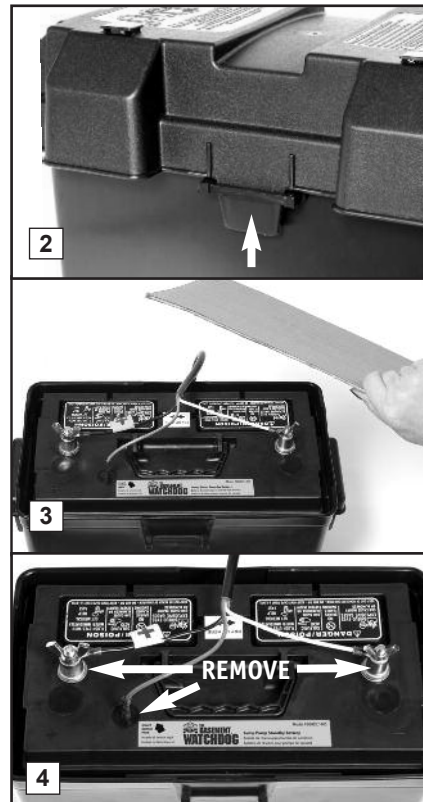

3. Fan the area around the top of the battery with a piece of cardboard (or another non-metallic material) to remove any hydrogen or oxygen gas that may have been emitted from the battery.

4. Remove the fluid sensor from the top of the battery. Unscrew the wing nuts and remove the battery cables.

5. Remove the old battery from the battery box and place the new battery in the box. Fill the battery following the instructions on page 8 or 9.

6. Clean any corrosion off of the ring connectors on the ends of the battery wires. Use a stiff brush or sandpaper. **DO NOT** apply corrosion resisting sprays or pads to the terminal rings or posts after you have cleaned them, since this could prevent the battery from charging properly.

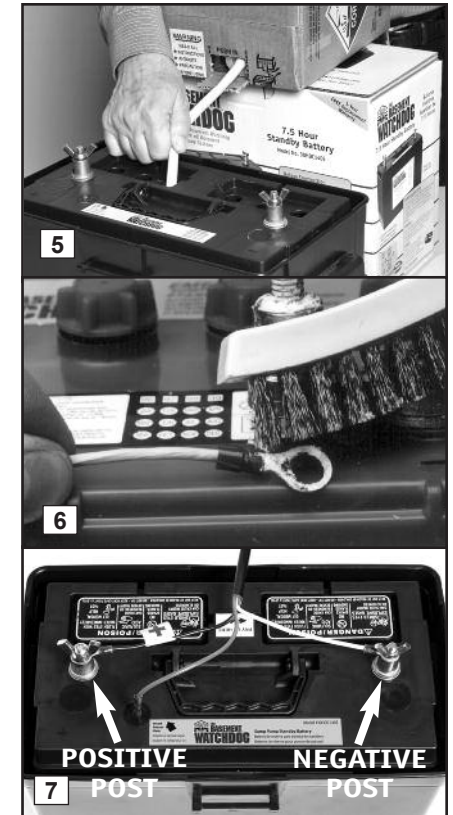

- Replace the battery cables, WHITE to the NEGATIVE (-) post and BLACK to the POSITIVE (+) post. Tighten the wing nuts. Slide the switch on the front of the controller to the type of battery used with the system (maintenance free or non-maintenance free battery).
- (a) If your battery has six (6) caps on the top, rinse and dry the cap with the extra hole from the old battery to remove any residue. Replace the battery cap in the cell that is 2nd from the POSITIVE post with the cap from the old battery. Insert the fluid sensor in the cap. (b) If your battery has two caps, each covering three (3) battery cells, you will not need to save the cap from the old battery.

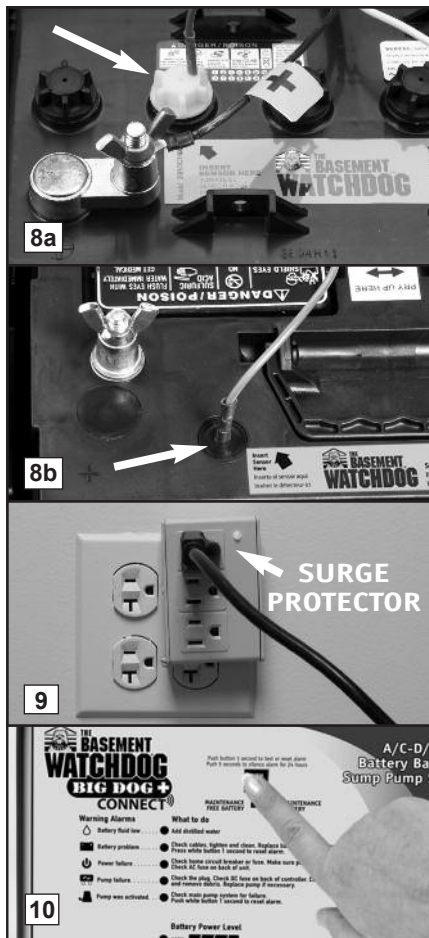

Simply insert the fluid sensor in the top of the battery next to the arrow.

- Plug the power cord back into the wall outlet. (You should provide additional protection for the control unit by using a surge protector.)
- If any of the alarms are sounding, press the BLUE button on the front of the control panel for one (1) second.

### ③ Power failure

There are several causes for power failure. The most common is a power outage by your electric company. During this emergency, the Basement Watchdog system will automatically switch to battery power and protect your basement from flooding.

You can silence the "Power failure" alarm for 24 hours by pressing the BLUE button for five (5) seconds. The alarm will be silent, but the light will stay on. The system will continue to operate while the power alarm is silenced. After 24 hours, the alarm will reset automatically.

- If the power is on in the rest of the house, check the home circuit breaker or fuse box for failure, and correct the problem.
- Check the power cord. Make sure it is securely plugged into the wall outlet. Make sure the outlet is working properly.
- The control unit may have received a power surge. (a) Check the AC fuse located on the back panel of the control unit. First, unplug the control unit from the wall outlet. (b) Then, unscrew the barrel fuse and check to see if the wires in the fuse are intact. To remove the barrel fuse, push in and turn counter clockwise. Replace the fuse by pushing it in and turning clockwise. If the wires are burned and broken, replace the fuse with a 5 amp glass barrel fuse, commonly found at hardware stores and auto supply stores. Plug in the control unit. (You should provide additional protection for the control unit by using a surge protector.) If the fuse blows again, call Glentronics technical support at 800-991-0466, option #3.

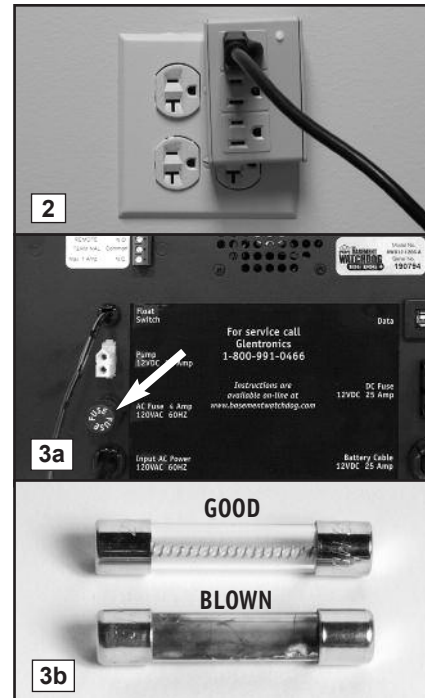

The control unit must receive 115 volts AC +/- 5% from the AC outlet. Any voltage lower than 110 volts will activate the "Power failure" alarm. Lower voltages can be caused by utility company brown outs or a heavy power draw from other appliances on the same circuit. Reduce the number of appliances on the circuit.

### ④ Pump failure

**⚠ DANGER**

**Unplug the main AC pump before servicing the backup pump to avoid electric shock. Failure to do so could cause serious injury or death.**

**REFER TO THE PHOTOS AT RIGHT**

The Basement Watchdog control unit will check the pump and its wire connections each week for possible pump failure. The system will test the pump by running it for 2-3 seconds to make sure it is operating. The test will not trigger an alarm. If the "Pump failure" alarm sounds:

- Check the pump plug in the back of the unit to make sure it is firmly connected. Check the pump wires to make sure they are connected securely to the pump plug. Check the rest of the pump wires for any possible breaks.
- If the pump wires are intact, the pump may be clogged. (a) Disconnect the control unit from the wall outlet, and disconnect the battery cables and the fluid sensor. (b) Release the union or check valve and remove the pump and rigid PVC pipe section from the sump pit. (c) Clear any debris from the strainer, and then reconnect the pump to the discharge pipe. (d) Connect the fluid sensor, and the battery cables to the battery...the WHITE wire to the NEGATIVE (-) post, and then the BLACK wire to the POSITIVE (+) post. Tighten the wing nuts on the battery posts. (e) Plug the control unit back into the wall outlet.

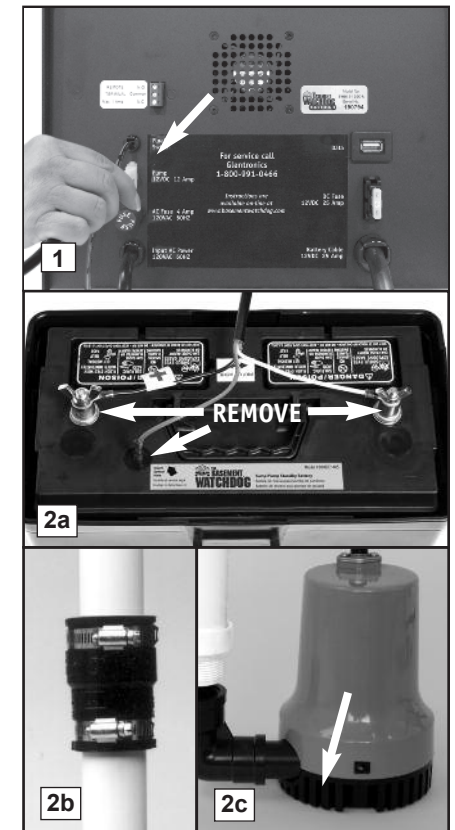

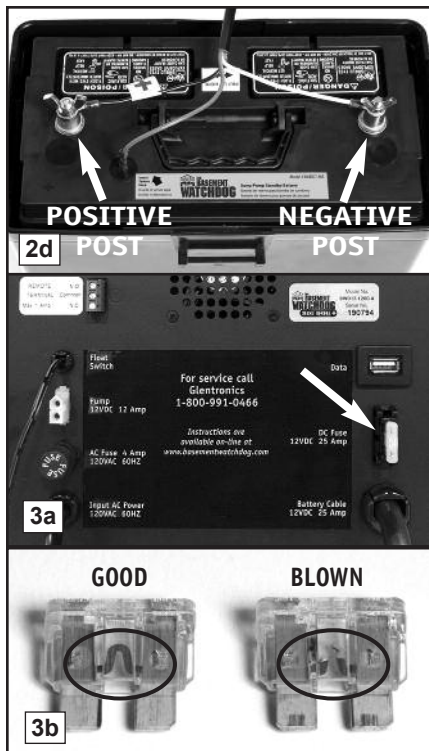

3. (a) Check the DC fuse by pulling it out of the fuse holder. (b) If the wire within the fuse is burned and broken, replace the fuse with a 25 amp DC safety fuse. If the fuse blows again, unplug the computer control unit from the wall and disconnect the battery cables from the battery. Then call Glentronics technical support for instructions at 800-991-0466, option #3. You may need to replace the pump.

4. Plug the main AC pump back into the wall outlet.

### ⑤ Pump was activated

When water rises in the sump pit and lifts the float switch, the pump will begin pumping, and the "Pump was activated" light and alarm will turn on. The pump warning stays on to alert you to the fact that the standby system was used to empty the water from the sump. Try to determine what caused the system to activate.

- Check the main pump for failure. It may not be working, the float switch may be stuck, or it may be too small to handle the inflow of water.
- Make sure the check valve is working and installed correctly. It may need to be replaced.
- Make sure the discharge pipe is not clogged or frozen.
- If the power was out, the backup pump was automatically activated. You need to push the BLUE button on the front of the control panel to silence the alarm.

## REPLACING THE PUMP

**⚠ DANGER**

Unplug the main AC pump when installing the backup pump to avoid electric shock. Failure to do so could cause serious injury or death. Review the safety instructions on page 1.

REFER TO PHOTOS AT LEFT AND ABOVE

1. Unplug the Basement Watchdog control unit from the wall outlet.
2. Remove the cover of the battery box by pushing in the tabs on the front and back, then lifting up.

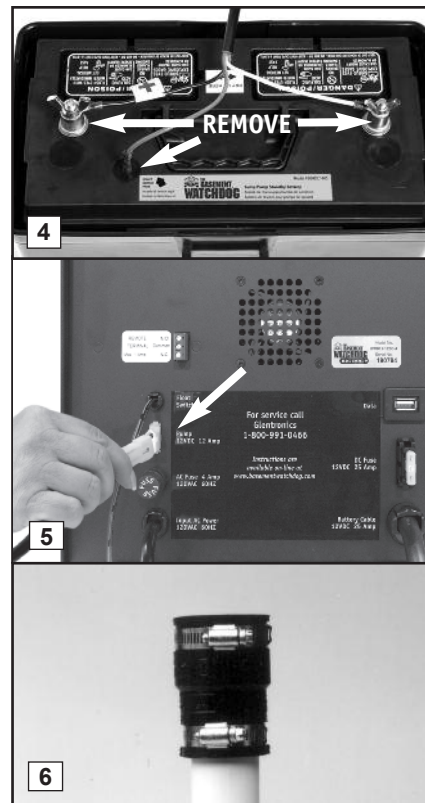
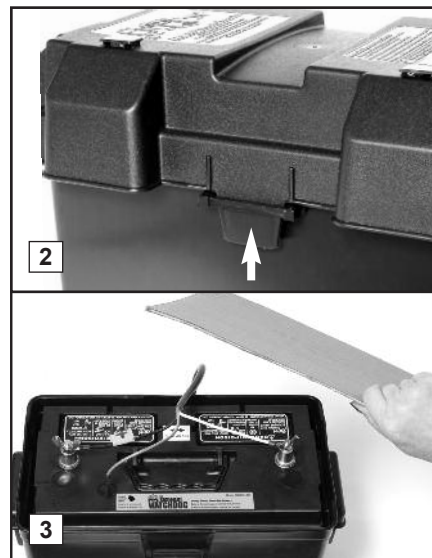

3. Fan the area around the top of the battery with a piece of cardboard (or another non-metallic material) to remove any hydrogen or oxygen gas that may have been emitted from the battery
4. Remove the fluid sensor and the battery cables from the battery.
5. Unplug the pump from the back of the control unit.
6. Release the union or check valve and remove the pump and the rigid PVC pipe section from the sump pit.
7. Unscrew the pipe and adapter from the old pump, and screw them into the new pump.
8. Lower the pump into the sump and reconnect the union or check valve.
9. Plug the pump wires into the back of the control unit.

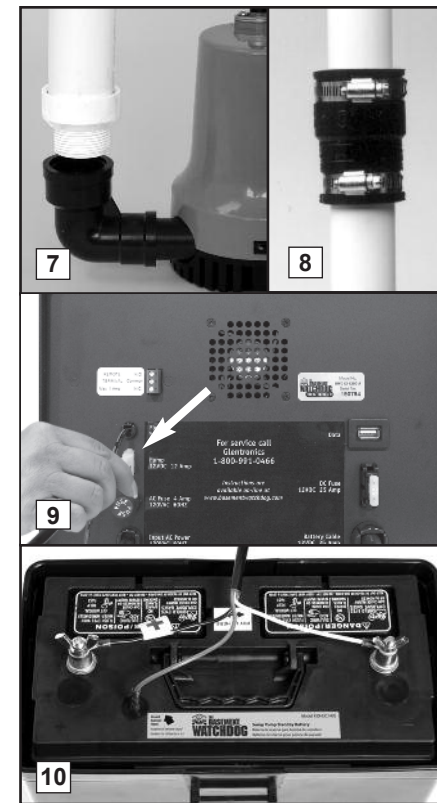

10. Replace the fluid sensor in the top of the battery. Connect the battery cables to the battery...the WHITE wire to the NEGATIVE (-) post, and then the BLACK wire to the POSITIVE (+) post. Tighten the wing nuts. Replace the fluid sensor.
11. Replace the cover of the battery box.
12. Plug the control unit and the main AC pump back into the wall outlet.
13. If any alarms are sounding, press the BLUE button on the front of the control panel for one (1) second to silence them.

### ⑥ Battery charge level

Your Basement Watchdog backup sump pump system has a gauge which will report the level of charge remaining in the battery. As the battery's energy is depleted during operation without AC



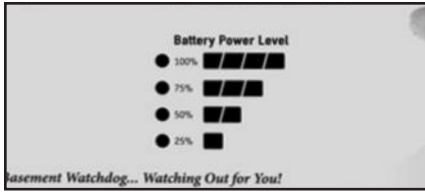

power, or simply by aging, the gauge will indicate the percent of charge remaining in the battery. Should the level drop below 25%, the "Battery problem" indicator will light up and the alarm will sound.

### TESTING THE FLOAT SWITCH

*It is important to manually test the float switch periodically or after any maintenance.*

### **⚠ DANGER**

Unplug the main AC pump when installing or servicing the backup pump to avoid electric shock. Failure to do so could cause serious injury or death. Review the safety instructions on page 1.

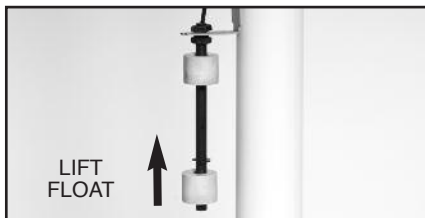

Lift the float up and let go. This will activate the pump. The control unit will run the pump for approximately 25 seconds so it can empty all the water in the sump pit. While the pump is active, water will come out of the 1/8" hole that was drilled into the PVC discharge pipe. This is normal. The hole is needed to prevent an air lock within the system. **DO NOT** obstruct the hole or an air lock may prevent the system from activating. If there is no water in the pit, the pump can run dry for this amount of time. The alarm will sound and the "Pump was activated" light will go on. After the pump has stopped, push the BLUE button on the front of the control panel to silence the alarm. **BE SURE TO PLUG IN THE MAIN AC PUMP WHEN YOU HAVE COMPLETED THE TEST.**

## Using the Remote Notification

### THE REMOTE TERMINAL

The Basement Watchdog Big Dog backup sump pump can be connected to a home security system or other alarm devices to alert you to a problem or required maintenance.



### INSTRUCTIONS FOR CONNECTING THE REMOTE ALARM

The terminal is located on the back of the control unit. There are three (3) positions for wire connections on the terminal: N.C. - normally closed, N.O. - normally open, and common.

Check your security system to determine whether an open (no contact) or closed (making contact) connection is needed to activate the alarm.

The security system will provide two connection terminals. You will need to extend wires from the security system to the control unit. Strip the two wires, 1/4" each. Connect either wire to the common terminal. To secure the wire into the terminal, insert the exposed wire into the hole on the back of the terminal next to the screw marked common. Turn the screw a few turns to lock-in the wire.

If the security system requires a closing of a contact to activate the alarm, secure the other wire in the terminal hole labeled N.O. (normally open). If the security system requires an opening of a contact, secure the wire in the terminal hole labeled N.C. (normally closed).

### USB DATA PORT

This system has been updated with a USB port on the back of the controller. The purpose of this

port is to allow communication with the Basement Watchdog Connect Modules.



### CONNECT MODULES



The Basement Watchdog Connect Modules are separately sold accessories that will allow the user to stay connected and receive remote notifications of potential problems and needed maintenance while away from home. There are currently two modules that can be connected:

#### Basement Watchdog WiFi Module (Model No. BW-WiFi)

- Sends emails or text notifications and status alerts to your phone, tablet or computer
- No required monthly or yearly fees or subscriptions

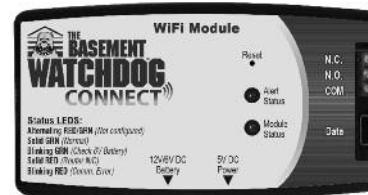

Model No. BW-WiFi

#### Basement Watchdog Home Automation Module (Model No. BW-HZM)

- Easily connects to compatible monitored security or home automation system

- Connects using Z-Wave Plus

Model No. BW-HZM



For more information, please visit [www.BasementWatchdog.com](http://www.BasementWatchdog.com)

### MAINTENANCE CHECK LIST

Maintenance should be performed 1-2 times per year

1. Lift the float switch as described at left.
2. Remove all debris from the bottom of the pit and pump strainer.
3. Remove all debris from the water.
4. Remove all debris from the float switch.
5. Fill the pit with water. Make sure the pump turns on at the intended level.
6. While the pump is running, make sure the pump is evacuating water at a good pace and water is coming out of the 1/8" air bleed hole.
7. Remove the fluid sensor and yellow cap from the battery and rinse any residue buildup from the bottom of the battery cap. Replace the cap and fluid sensor.
8. Check and clean battery terminals.
9. Check battery fluid levels once every four to six months.

### PARTS & SERVICE INFORMATION

You can receive technical support, parts, or service information by calling Glentronics, Inc. at **800-991-0466, option #3**, or by visiting the Basement Watchdog website at [www.basementwatchdog.com](http://www.basementwatchdog.com). Send your unit to the following address if repairs are needed:

Glentronics, Inc.  
645 Heathrow Drive  
Lincolnshire, IL 60069-4205

# Troubleshooting Guide



Read safety warnings & instructions before attempting any repairs or maintenance.

Potential Cause	BATTERY FLUID LOW	Solutions
The battery fluid is low	Add distilled water to each cell of the battery	
The fluid sensor is installed improperly	The fluid sensor should be inserted into the designated hole on the top of the Watchdog battery and pushed down	
Not using a Watchdog battery	This feature cannot be used. Attach the fluid sensor to the positive post of the battery	
Potential Cause	BATTERY PROBLEM	Solutions
Terminals are corroded	Clean terminals & cables	
Cables are loose	Tighten wing nuts	
Battery is discharged below 25%	Replace battery if power is out. There is only 1 hour of continuous pumping power left. Battery will recharge when power is restored	
Battery is old or damaged	Replace battery if 5-7 years old	
Potential Cause	POWER FAILURE	Solutions
Power outage	None. The backup pump will run off the battery. Press and hold the reset button to silence the alarm for 24 hours	
An outlet, fuse or circuit breaker has failed	Try another outlet, replace the fuse, or reset the circuit breaker	
The power cord is unplugged from the wall	Make sure the power cord is plugged in securely	
The charger is receiving less than 110 volts from the outlet	None, if the utility company has instigated brown outs. Otherwise, reduce the number of other appliances on the circuit	
Potential Cause	PUMP FAILURE	Solutions
Backup pump is unplugged	Make sure the pump is securely plugged into the back of the control unit	
Backup pump is clogged	Remove strainer from pump and clean out any debris	
Backup pump is broken	Replace the pump	
Potential Cause	PUMP WAS ACTIVATED	Solutions
The main AC pump failed because of a power outage	The backup pump was activated when needed. Push the reset button to reset the alarm	
The float switch on the main pump is stuck or defective	Free the float switch on the main pump or replace it	
The main AC pump is broken	Replace the main AC pump	
The main AC pump could not keep up with the inflow of water	None. The backup pump was activated as needed. If this is a recurring problem, install a higher capacity main pump. Push the reset button to reset the alarm	
The check valve is stuck or installed improperly and the water cannot pass through it	Replace the check valve or correct the installation	
The discharge pipe is clogged or frozen and the water cannot pass through it	Thaw, clean out the blockage, or replace the discharge pipe	
There is a slight chance of false activation if the float switch cord is wrapped around the AC power cord	Move the float switch cord away from the AC power cord	
Potential Cause	DC FUSE HAS BLOWN	Solutions
Pump is clogged	Remove strainer from pump. Clean out any debris. Replace the 25 amp DC fuse	
Pump wires are exposed	Replace the pump	
Pump is broken	Replace the pump	
Potential Cause	AC FUSE HAS BLOWN	Solutions
The control box received a power spike	Plug the control box into a surge protector. Replace the 5 amp, 250 volt, slow-blow, glass barrel fuse on the back of the control unit	
Potential Cause	WATER WILL NOT LEAVE THE PIT	Solutions
No check valve	If connecting backup to the primary discharge pipe, make sure there is a check valve on both the main and backup pipes below the tie-in point	
Check valve is broken or installed improperly	Make sure check valve is functioning and installed properly	
Discharge pipe is clogged or frozen	Clear the discharge pipe	
There is an air lock in the system	Make sure the 1/8" weep hole is drilled in the discharge pipe below the check valve, but above the water line. Make sure it is clear of debris	
Potential Cause	SYSTEM DOES NOT OPERATE AFTER INSTALLATION	Solutions
The battery cables are connected backwards	Reverse the battery connections	

If the remedies in the troubleshooting guide do not resolve the problem, follow the instructions within this manual to disconnect the system from the outlet and the battery terminals, reconnect the system and then push the reset button. If the problem continues, contact customer service.

## CHECK OUT THESE OTHER BASEMENT WATCHDOG PRODUCTS

### AC PUMPS

#### *Industrial Grade Pumps for the Residential Market*

The Basement Watchdog line of AC sump pumps are strong, dependable and so energy efficient, they could pay for themselves in a few years. The sump pumps are equipped with dual float switches for added reliability. When your main AC pump needs replacement, consider upgrading to one of the pumps in the Basement Watchdog line.



### FLOAT SWITCHES

#### *What's the most common reason your main AC pump fails?*

It's probably the result of a float switch that is stuck or broken. Replace it with a Basement Watchdog dual float and controller for reliable operation. The dual float has, not one, but two floats mounted within a protective cage. Should one float fail to operate, the second float automatically activates the pump. The protective cage prevents debris or other wires from interfering with the movement of the float. It can be used to replace the float on most AC pumps.



### CHECK VALVES

#### *What's a Klunkless Check Valve™?*

If you've spent any time in your basement, you've probably noticed your sump pump turning on and off with a loud clunk. That's the result of the water pressure slamming the valve closed in the check valve. The Klunkless Check Valve has a built-in air chamber to counteract that pressure and muffle the sound. It works just like a conventional check valve, only quieter.



### WATER ALARMS

#### *Minimize the risk of water damage*

You can detect leaks before they become bigger problems by placing a water alarm wherever there is a risk of water damage...in the utility room, laundry room, kitchen, bathroom or basement. The alarm will sound when as little as 1/32" of water reaches the sensor.



## Limited Warranty

By opening this package and using this GLETRONICS, INC. product, you are agreeing to be bound by the terms of the GLETRONICS, INC. limited warranty (“warranty”) as set out below. Do not use your product until you have read the terms of the warranty. If you do not agree to the terms of the warranty, do not use the product and return it within the return period stated on your purchase receipt from the retail store or authorized distributor where you purchased it for a refund.

To the extent permitted by law, this warranty and the remedies set forth are exclusive and in lieu of all other warranties, remedies and conditions, whether oral, written, statutory, express or implied. GLETRONICS, INC. disclaims all statutory and implied warranties, including without limitation, warranties of merchantability and fitness for a particular purpose and warranties against hidden or latent defects, to the extent permitted by law. GLETRONICS, INC. will not be liable for any incidental, special or consequential damages for breach of any express or implied warranties on this product. In so far as such warranties cannot be disclaimed, GLETRONICS, INC. limits the duration and remedies of such warranties to the duration of this express warranty and, AT GLETRONICS, INC.'s option, the repair or replacement services described below. Some states (countries and provinces) do not allow limitations on how long an implied warranty (or condition) may last, so the limitation described above may not apply to you.

Any and all causes of action arising from, filed as a result of or in reference to, this warranty or the products described under this warranty shall be governed by and construed under the laws of the State of Illinois. Any cause of action arising from, filed as a result of or in reference to, this warranty or the products described under this warranty shall be filed only in the Circuit Court of the 18th Judicial District, Lake County, Waukegan, Illinois, or in the Northern District of Illinois if filed in Federal Court. The maximum liability for any product described in this warranty shall be the cost of product replacement only.

If any term is held to be illegal or unenforceable, the legality or enforceability of the remaining terms shall not be affected or impaired.

### What is Covered by this Warranty?

GLETRONICS, INC. warrants to the end purchaser that its pumps, switch and control unit products are free from defective materials and workmanship for the periods indicated below:

All parts and labor (excluding installation) for a period of:

- 2 years from the date of purchase, when used intermittently as a sump pump

The defective product must be returned directly to the factory, postage prepaid with the original bill of sale or receipt to the address listed below. GLETRONICS, INC., at its option, will either repair or replace the product and return it postage prepaid.

### What is NOT Covered by this Warranty?

This warranty does not cover the cost or value of damaged property, including expressly any property that has been affected by water overflow, seepage or flooding. If GLETRONICS, INC. determines that a product is deemed defective under this warranty agreement, it will repair or replace the PRODUCT

ONLY. GLETRONICS, INC. will not cover the cost to reinstall the product, nor will GLETRONICS, INC. pay the cost of having a plumber or contractor repair or replace the product.

GLETRONICS, INC. will not repair or replace a product that was installed incorrectly. A product shall be considered “installed incorrectly” when it deviates in any way from the instructions described in this manual.

This warranty does not cover product problems resulting from handling liquids hotter than 104 degrees Fahrenheit, handling inflammable liquids, solvents, strong chemicals or severe abrasive solutions; user abuse; misuse, neglect, improper maintenance, commercial or industrial use; improper connection or installation, damages caused by lightning strikes; excessive surges in AC line voltage; water damage to the controller; other acts of nature, or failure to operate in accordance with the enclosed written instructions.

### How to Obtain Warranty Service

Within thirty (30) days of the product’s defective performance, the unit must be shipped, freight prepaid, or delivered to GLETRONICS, INC. to provide the services described hereunder in either its original carton and inserts, or a similar package affording an equal degree of protection. Products not received by GLETRONICS, INC. at the address indicated below within thirty (30) days of the product’s defective performance will not be considered for warranty service. Products received after two (2) years from the date of purchase, fall outside of the timeframe for warranty service and will not be eligible for warranty service. The product must be returned to GLETRONICS, INC. for inspection in order to be considered for warranty service. If the product is not returned to GLETRONICS, INC. or the product is inspected by any person, plumber, contractor or business other than GLETRONICS, INC., this warranty shall no longer be valid. Prior to defective operation, the unit must not have been previously altered, repaired or serviced by anyone other than GLETRONICS, INC., or its agent; the serial number on the unit must not have been altered or removed; the unit must not have been subject to accident, misuse, abuse or operated contrary to the instructions contained in the accompanying manual. The dealer's dated bill of sale, or installer's invoice must be retained as evidence of the date of purchase and to establish warranty eligibility.

### Where are Products Sent for Warranty Service?

Glenronics, Inc., 645 Heathrow Drive, Lincolnshire, IL 60069

### How Can I Obtain More Information?

By calling 800-991-0466.