



Thinking of you
Electrolux



EN REFRIGERATOR
FR RÉFRIGÉRATEUR
ES REFRIGERADOR

USE AND CARE GUIDE
GUIDE D'UTILISATION ET D'ENTRETIEN
GUIA DE USO Y CUIDADO



2 Finding Information

Please read and save this guide

Thank you for choosing Electrolux, our new premium brand in home appliances. This Use & Care Guide is part of our commitment to customer satisfaction and product quality throughout the service life of your new appliance.

Keep a record for quick reference

Purchase date

Electrolux model number

Electrolux serial number



NOTE

Registering your product with Electrolux enhances our ability to serve you. You can register online at www.electroluxappliances.com or by sending your Product Registration Card in the mail.

Questions?

For toll-free telephone support in the U.S. and Canada: 1-877-4ELECTROLUX (1-877-435-3287)

For online support and product information visit <http://www.electroluxappliances.com>

Table of contents

Finding Information	2
Safety	3
Feature Overview.....	5
Installation	6
Installing Door Handle.....	7
Leveling.....	8
Door Removal & Temperature Control.	9
Electronic Control & Alarms.....	10
Alarms & Sabbath Mode	11
Air Filter & Luxury Design™ Lighting.....	12
Storage Components.....	13
Storing Food & Saving Energy.....	15
Care and Cleaning	16
Solutions to Common Problems.....	17
Warranty Information.....	20

Installation Checklist

Doors

- Handles are secure and tight
- Door seals completely to cabinet on all sides
- Freezer drawer is level across top

Leveling

- Refrigerator is level, side-to-side and front-to-back
- Toe grille is properly attached to refrigerator
- Cabinet is set solid on all corners

Electrical Power

- House power turned on
- Refrigerator plugged in

Air Filter

- Air Filter is installed

Final Checks

- Shipping material removed
- Fresh food and freezer temperatures set
- Crisper humidity controls set
- Registration card sent in

Important safety instructions

Safety Precautions

Do not attempt to install or operate your unit until you have read the safety precautions in this manual. Safety items throughout this manual are labeled with a Danger, Warning, or Caution based on the risk type.

Definitions

 This is the safety alert symbol. It is used to alert you to potential personal injury hazards. Obey all safety messages that follow this symbol to avoid possible injury or death.



DANGER

DANGER indicates an imminently hazardous situation which, if not avoided, will result in death or serious injury.



WARNING

WARNING indicates a potentially hazardous situation which, if not avoided, could result in death or serious injury.



CAUTION

CAUTION indicates a potentially hazardous situation which, if not avoided, may result in minor or moderate injury.



IMPORTANT

Indicates installation, operation, or maintenance information which is important but not hazard-related.

General Safety



WARNING

Please read all safety instructions before using your new refrigerator.

- Do not store or use gasoline or other flammable liquids near this or any other appliance. Read product labels for warnings regarding flammability and other hazards.
- Do not operate the appliance in the presence of explosive fumes.
- Avoid contact with any moving parts of the automatic ice maker.

- Remove all staples from the carton to avoid injury. Staples can also damage finishes if they come in contact with other appliances or furniture.

Child Safety

Packing Materials:

- Packing cartons covered with rugs, bedspreads, plastic sheets, or stretch wrap may become airtight chambers and can quickly cause suffocation.
- Destroy or recycle the product's carton, plastic bags, and any other exterior wrapping material immediately after the unit is unpacked. Children should never play with these items.

Child Entrapment and Suffocation:

- These problems are not limited to the past. Whether junked, abandoned, or temporarily stored (even for a few hours), unattended appliances are dangerous. Please take the precautions listed below.

Proper Disposal of Appliance

We strongly encourage responsible appliance recycling/disposal methods. Check with your utility company or visit www.energystar.gov/recycle for more information on recycling your old unit.

Before you recycle or dispose of your old appliance:

- Remove the doors.
- Leave the shelves and baskets in place so children may not easily climb inside.
- Have refrigerant and compressor oil removed by a qualified service technician.

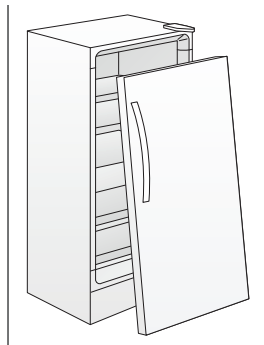

4 Safety

Electrical information



WARNING

You must follow these guidelines to ensure that your appliance's safety mechanisms are operating correctly.

- The unit must be plugged into its own dedicated 115 Volt, 60 Hz, AC-only non-GFCI electric outlet. The power cord of the appliance is equipped with a three-prong grounding plug for your protection against electrical shock hazards. It must be plugged directly into a properly grounded three-prong receptacle. The receptacle must be installed in accordance with local codes and ordinances. Consult a qualified electrician. Do not use an extension cord or adapter plug.
- If the power cord is damaged, it should be replaced by the manufacturer, service technician, or a qualified person.
- Never unplug the appliance by pulling on the power cord. Always grip the plug firmly and pull straight out from the receptacle to prevent damaging the power cord.
- To avoid electrical shock, unplug the unit or switch the breaker that supplies power to the unit to the off position before cleaning and before replacing a light bulb or LED light.
- Performance may be affected if the voltage varies by 10% or more. Operating the appliance with insufficient power can damage the compressor. Such damage is not covered under your warranty.
- Do not plug the unit into an outlet controlled by a wall switch or pull cord to prevent the appliance from being turned off accidentally.



IMPORTANT

To disconnect power to the unit, unplug the unit or switch the breaker that supplies power to the unit to the off position.

Grounding type wall receptacle

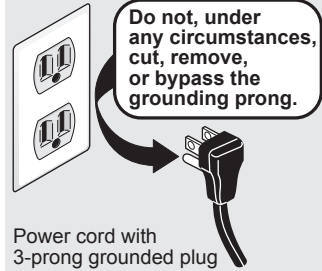

Understanding features and terms

Your Electrolux appliance is designed for optimal convenience and storage flexibility. The illustration below is provided to assist you with familiarizing yourself with product features and terminology.



NOTE

*Features may vary according to model.

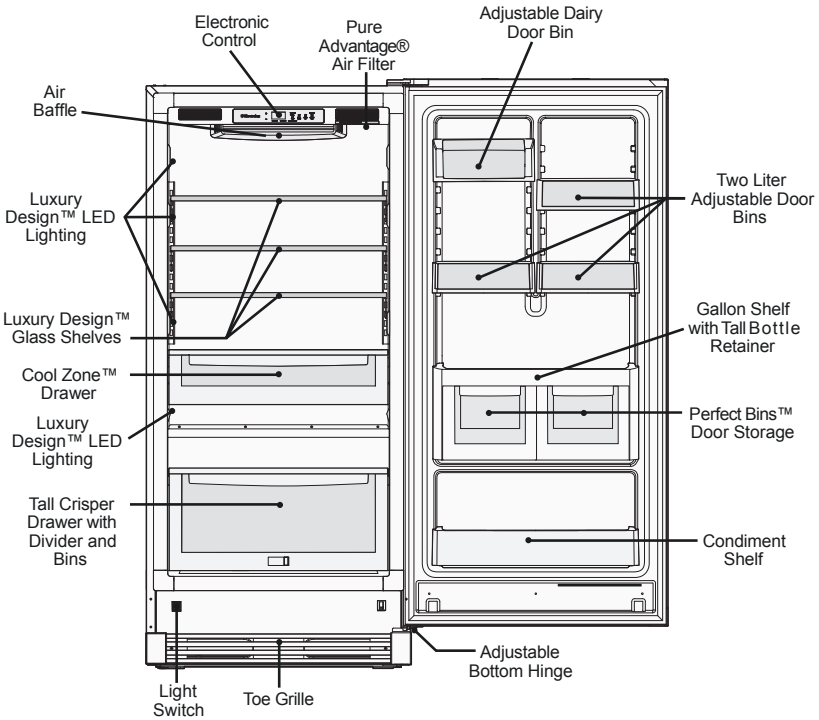

6 Installation

Required Tools

You will need the following tools:

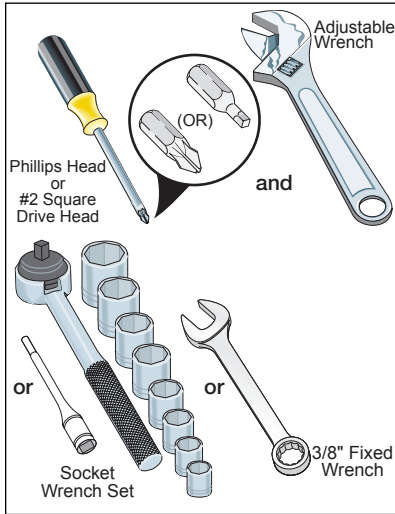

This Use & Care Guide provides general installation and operating instructions for your model. We recommend using a service or kitchen contracting professional to install your appliance. Use the unit only as instructed in this Use & Care Guide.

Before starting the appliance, follow these important first steps.

Location

- Choose a place that is near a grounded, non-GFCI, electrical outlet. **Do Not** use an extension cord or an adapter plug.
- If possible, place the unit out of direct sunlight and away from the range, dishwasher, or other heat sources.
- The appliance must be installed on a floor that is level and strong enough to support a fully loaded unit.



CAUTION

DO NOT install the appliance where the temperature will drop below 40°F (13°C) or rise above 110°F (43°C). The compressor will not be able to maintain proper temperatures inside the unit.

DO NOT block the toe grille on the lower front of your appliance. Sufficient air circulation is essential for the proper operation of your unit.



NOTE

If your appliance is placed with the door hinge against a wall, you may have to allow additional space so the door can be opened wider.

Installation

- Allow the following clearances for ease of installation, proper air circulation, and plumbing and electrical connections:

Sides	3/8" (9.5 mm)
Top & Back	1" (25.4 mm)
- Allow for trim kit if it is to be installed with the unit.



NOTE

The appliance doors are designed to shut by themselves within a 20-degree opening.

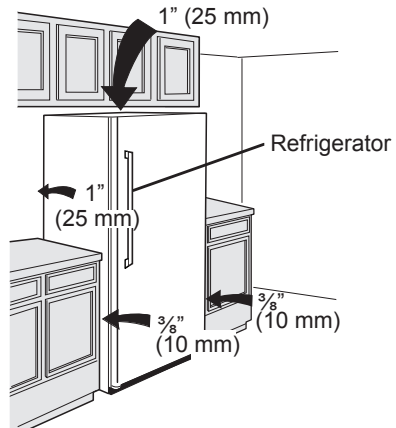

Door Handle Mounting Instructions

1. Remove handle from carton and any other protective packaging.
2. Position refrigerator handle end caps over upper and lower pre-installed shoulder bolts (A) that are fastened into door, ensuring the holes for the set screws are facing towards the outside of door if a single unit installation or the freezer door (if installing the matching freezer)
3. While holding handle firmly against door, fasten upper and lower Allen set screws (B) with supplied Allen wrench.
4. Repeat steps 2 and 3 to install freezer handle (if installing the matching freezer). Ensure the holes for the set screws are facing towards the freezer door.

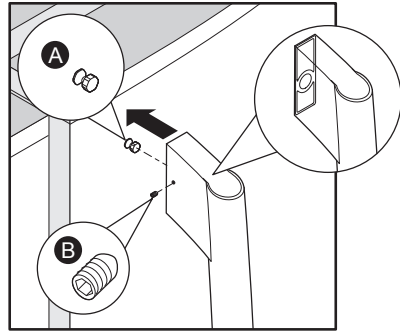

Single Unit Installation

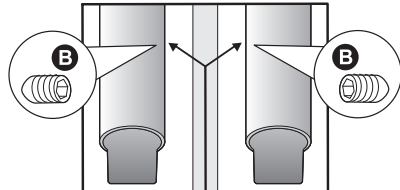

Ensure handle set screws are facing each other with doors closed

Matching Refrigerator and Freezer Door Handle Installation



NOTE

All set screws should be tightened and sub-flush (Allen set screw should be seated just below the surface of the end cap) of handle end cap. The end caps should be drawn tight to door with no gaps.

Toe Grille Removal

To remove the toe grille, use a Phillips head screwdriver and remove the two screws holding the toe grille to the cabinet. Then pull the toe grille away from the unit.

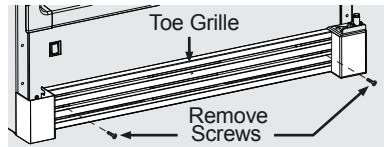

Leveling

- The refrigerator must have all bottom corners resting firmly on a solid floor.
- The floor must be strong enough to support a fully loaded refrigerator.
- It is **VERY IMPORTANT** for your refrigerator to be level in order to function properly. If the refrigerator is not leveled during installation, the door may be misaligned and not close or seal properly, causing cooling, frost or moisture problems.

8 Leveling

To Level The Refrigerator:

While unit is lying on its back, note the location of the 4 leg levelers installed at each corner. These leg levelers will be used to level the refrigerator and to adjust the height. Use a carpenter's level to level the refrigerator from front to back and side to side. Adjust the plastic leveling feet in front, ½ bubble higher, so that the door closes easily when left halfway open.



NOTE

Make sure to allow for the Trim and Leveling Kit if it is to be installed with the unit.

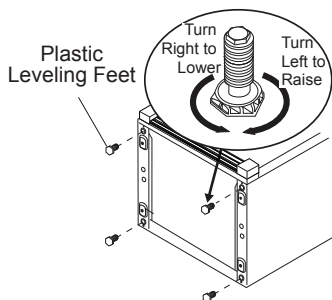

Leveling Instructions For Matching Tall Refrigerator / Tall Freezer Pair:

- Level door of first unit using all four levelers and slide unit into place. Recheck for levelness and adjust if necessary.
- Measure distance from floor to bottom of door on first unit. Adjust and level second unit so door height matches.
- **Leg Level Adjustments:**
One full turn of all four leg levelers will raise door 5/32".
- Slide second unit into place leaving a minimum gap of 3/16" between units for door swing clearance.
- This last step may require at least one extraction of the second unit to properly align units in a "built-in" application.

Leveling Door with Adjustable Hinge

Use the lower hinge adjustment to fine tune the door height and for final cabinet spacing. Use a 7/16" socket or wrench to adjust the screw at the bottom of the lower hinge.

Adjusting Doors For Matching Tall Refrigerator / Tall Freezer Pair

The doors may also be adjusted side to side with the slotted hinge for aligning the doors parallel to each other. Loosen the two bolts with a 3/8" wrench and one screw with a Phillips screwdriver. Shift the doors until parallel; then retighten the screws securely. (See illustration below.)

Lower Hinge Adjustment For Leveling The Doors Of The Matching Tall Refrigerator / Tall Freezer Pair

To level the doors using the adjustable lower hinge (some models):

1. If the refrigerator door is lower than the freezer door, raise the refrigerator door by turning the adjustment screw clockwise using a 7/16" socket wrench. (See illustration below.)
2. If the freezer door is lower than the refrigerator door, raise the freezer door by turning the adjustment screw clockwise using a 7/16" socket wrench. (See illustration below.)

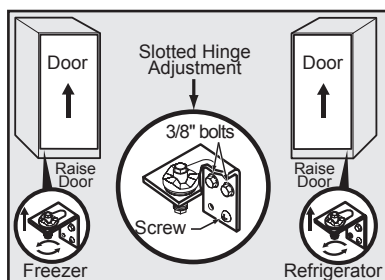

Door Removal

If door must be removed:



CAUTION

Doors are heavy. It is recommended to have two people remove or replace the door assembly from the cabinet.

- Unplug the unit or switch the breaker that supplies power to the unit to the off position.
- Remove the plastic top hinge cover.
- Hold the door in place while removing the top hinge from the cabinet.
- Remove the two $\frac{3}{8}$ " hex head bolts from the top hinge with a $\frac{3}{8}$ " wrench or socket.
- Lift the door upwards and pull up and away from the cabinet until free of the bottom hinge pin mounted on the front of the cabinet.
- To replace the door, reverse the above procedures and securely tighten all screws to prevent hinge slippage.

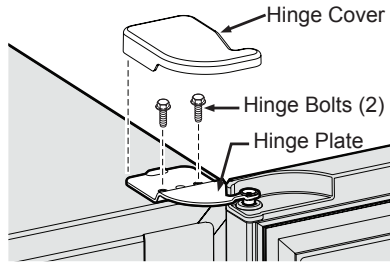

Setting The IQ Touch™ Electronic Control

COOL DOWN PERIOD

For safe food storage, allow 4 hours for the appliance to cool down completely. The unit will run continuously for the first several hours.

IQ TOUCH™ ELECTRONIC CONTROL

The IQ Touch™ Electronic Control is located inside the appliance. Temperature is factory preset to provide satisfactory food storage temperatures. However, the temperature control is adjustable to provide a range of temperatures for your personal satisfaction.

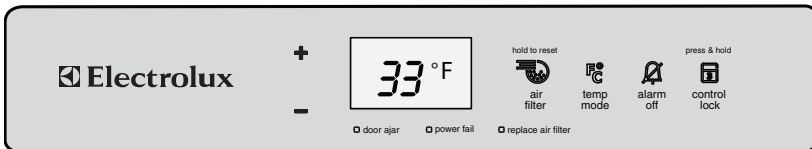

To adjust the temperature setting, press the UP (+) key for warmer temperature and DOWN (-) key for colder temperature on the control panel. Allow several hours for the temperature to stabilize between adjustments. The unit can be adjusted between 33°F (1°C) and 46°F (8°C). By pressing the TEMP MODE key, the temperature display will toggle between °F to °C.

To turn the appliance OFF, press the UP (+) key until the warmest temperature setting of 46°F (8°C) show in the display. Then press the UP (+) key 3 times within 3 seconds to turn the unit OFF. The display will then scroll "OFF" across the display. To turn the unit back ON, press the DOWN key 3 times within 3 seconds. The control will then display "46°F (8°C)" and may be adjusted to the desired temperature.

10 Electronic Control & Alarms

IQ Touch™ Electronic Control Features

Replace Air Filter

When the “REPLACE AIR FILTER” LED is illuminated yellow, the air filter needs to be replaced. The control will signal for air filter replacement after 3600 hours of operation. After replacing the air filter, reset the air filter timer by pressing the AIR FILTER key for 3 seconds. The “REPLACE AIR FILTER” LED will be illuminated green for 3 seconds, confirming a timer reset.

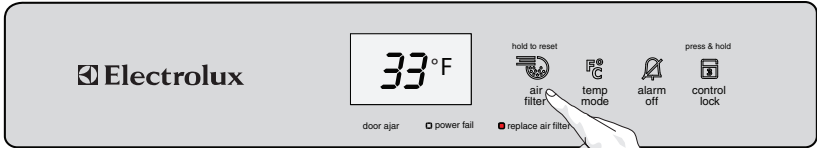

Control Lock

To disable the keypads on the control, begin by pressing the CONTROL LOCK key for 3 seconds until “LO” is displayed for 1 second. With the control locked, when keys are pressed on the control panel, “LO” will be displayed. To unlock the control, press the CONTROL LOCK key for 3 seconds. The display will show “UL” for 1 second.



Power Fail

The POWER FAIL indicator light informs you that due to a power failure, the cabinet temperature exceeded 55°F (13°C). If the power failure lasted more than 1 hour, the display alternates between showing the power failure duration (Hours and DURATION LED illuminate in the display) and the cabinet temperature (°F or °C illuminates) every ½ second. This safety feature will aid in determining what food spoilage action to take.

The Power Fail indicator light and duration display can be turned off by pressing the ALARM OFF key.

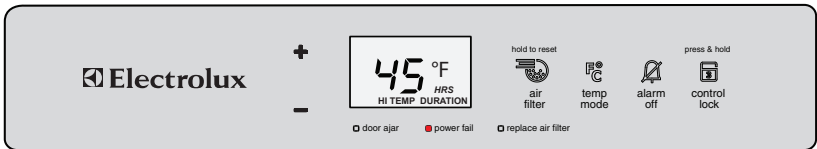

Alarms

There are 4 possible conditions that will cause the alarm tone to sound.

High Temp Alarm

If the temperature inside the cabinet exceeds 55°F (13°C), the HIGH TEMP LED will illuminate, and after 1 hour, the HIGH TEMP Alarm will sound and the cabinet temperature is shown in the display. The LED and temperature alarm will remain active until the cabinet temperature is below 55°F (13°C).

The audible alarm can be turned off by pressing ALARM OFF key.

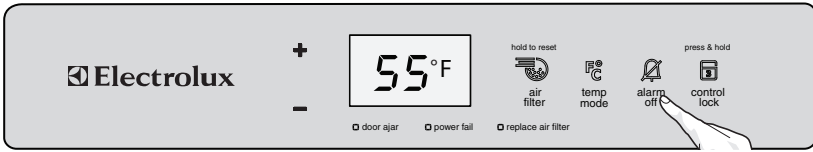

Door Ajar Alarm

This alarm will sound to alert you that the door has been open for 5 minutes or more. The DOOR AJAR LED will illuminate and the audible alarm will sound until the door is closed.

The audible alarm can be turned off by pressing the ALARM OFF key or by closing the door. If the door is ajar for 15 minutes, the interior light will turn off.

Temp Sensing Error Alarm

The sensor alarm signals you that a problem exists with a temperature sensor. The audible alarm will sound after 1 hour and the display will alternate between "E8" or "E9" and 33°F (1°C) at ½ second intervals. The control will then enter a mode that runs the appliance in a manner that maintains the factory set cabinet temperature.

The audible alarm can be turned off by pressing the ALARM OFF key.

Stuck Key Alarm

The stuck key alarm will sound if the control reads a keypress for longer than 30 seconds. The audible alarm will sound and will be limited to 1 minute and will stop automatically. The display will alternate between "E7" and 33°F (1°C) at ½ second intervals. The control will then enter a mode that runs the unit in a manner that maintains the factory set cabinet temperature until the condition is resolved.

The audible alarm can be turned off by pressing the ALARM OFF key.

Sabbath Mode

The Sabbath Mode is a feature that disables portions of the appliance and its controls in accordance with the observance of the weekly Sabbath and religious holidays within the Orthodox Jewish community.

To initiate or cancel Sabbath Mode, press the CONTROL LOCK and TEMP MODE keys at the same time and hold for 3 seconds. The display will now show "Sb" and the confirmation tone will sound. When AC power is cycled while the control is in Sabbath mode, the control enters into Sabbath mode automatically. "Sb" will again be displayed. While in Sabbath Mode, the display will show "Sb" for 1 second if any key is pressed.

In the interest of food safety, only the HIGH TEMP Alarm remains active and takes precedence over other Sabbath Mode features.



For further assistance, guidelines for proper usage and a complete list of models with the Sabbath feature, please visit the web at <http://www.star-k.org>.



12 Air Filter & Luxury Design™ Lighting

Pure Advantage™ Air Filter

Your new Pure Advantage™ air filter is located inside one of the 2 Liter Door Bins. The air filter cover is located on the upper right side of the control box. In general, you should change the air filter with Part Number “EAFCBF” every six months to ensure optimal filtering of appliance odors. The replacement air filter can be purchased on the Electrolux website (<http://www.electroluxappliances.com>) or call toll free in the U.S. and Canada: 1-877-4ELECTROLUX (1-877-435-3287). Your electronic control is equipped with a Change Filter Indicator to remind you to change your filter. See page 10.

To Install Or Replace The Air Filter

- Pull down on the front of the Pure Advantage™ air filter cover. This releases the hinged bottom cover to drop open.
- Remove the old filter and discard it.
- Unpackage the new filter and place it inside the hinged bottom cover of the housing.
- Push the hinged bottom cover upward until the tab snaps into closed position.

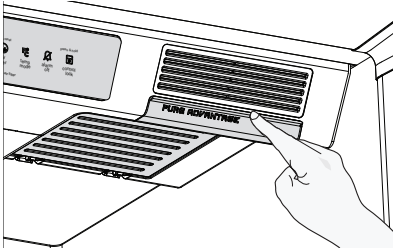

Open air filter cover

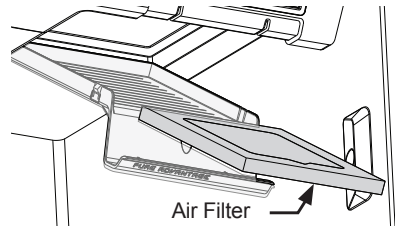

Air Filter
Remove air filter

Luxury Design™ Lighting

The interior cabinet lighting features LED lights that gradually ramp up in intensity after the door is opened.

To replace an LED:



WARNING

Unplug the unit or switch the breaker that supplies power to the unit to the off position before changing an LED light.

1. Unplug the electrical cord or switch the breaker OFF the power supply breaker.
2. Push down on the LED cover and then pull away from the cabinet interior.
3. From the inside of the LED cover, remove the wire harness connector by pressing on the latch with a small flat-bladed screwdriver. Pull the wire harness connector out of the LED.
4. Replace with a new LED and install in the reverse order.

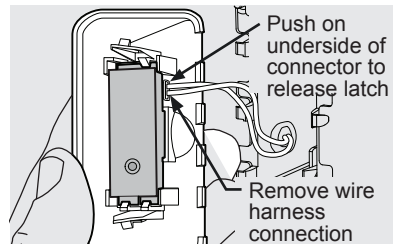
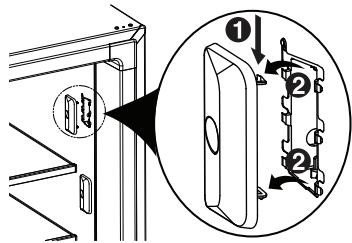

Push on underside of connector to release latch

Remove wire harness connection

Luxury Design™ Glass Shelves

Multi-position adjustable slide out glass shelves can be moved to any position for larger or smaller packages. The shipping spacers that stabilize the shelves for shipping may be removed and discarded.

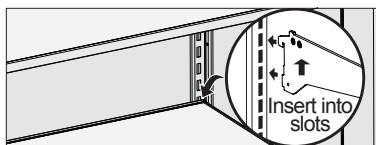

To Adjust The Shelves

- Lift front edge up.
- Pull shelf out.
- Replace the shelf by inserting the hooks at rear of the shelf into the wall bracket. Lower the shelf into the desired slots and lock into position.

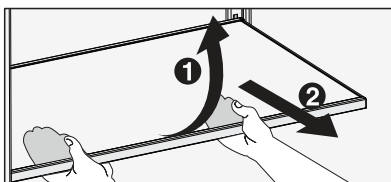

Cool Zone™ Drawer

This model is equipped with a Cool Zone™ Drawer for storage of luncheon meats, spreads, cheeses, and other deli items.

Crisper Drawer With Adjustable Dividers

The crisper drawer, located at the bottom of the unit interior, is designed for storing fruits, vegetables, and other fresh produce. Wash items in clean water and then remove excess water before placing them in the crisper. Items with strong odors or high moisture content should be wrapped before storing. Dividers may be adjusted for different size items within the crisper.

To remove the Crisper Drawer or Cool Zone™ Drawer:

1. Remove the glass cover from the drawer to be removed.
2. With both hands, lift up on the front of the drawer until it releases from the side supports.
3. Carefully remove the drawer from the appliance.

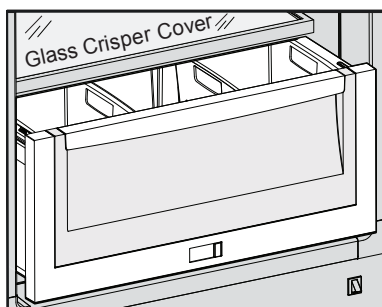
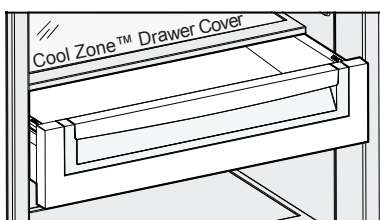

NOTE

Leafy vegetables keep best when stored with the humidity control set on HIGH HUMIDITY, or in a drawer without a humidity control. This keeps incoming air to a minimum and maintains maximum moisture content.

14 Storage Components

Adjustable 2-Liter Door Bins

This model is equipped with adjustable door bins that can be moved to suit individual needs.

To Move Door Bins:

- Lift the bin straight up.
- Remove the bin.
- Place the bin in desired position.
- Lower the bin onto supports until locked in place.

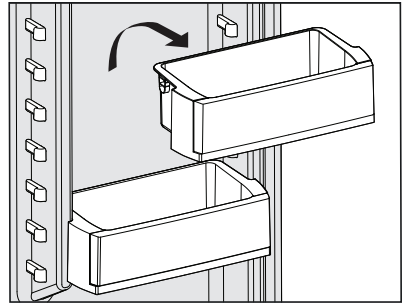

Adjustable Dairy Bin

Use the dairy compartment, at the top of the fresh food compartment door, for short term storage of cheese, spreads, or butter. The dairy compartment is designed to be warmer than the open storage area to accommodate these types of food.

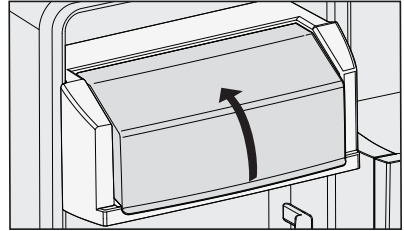

Full Width Gallon Bin And Perfect Bins™ Door Storage

The full width gallon bin is especially designed to hold gallon-sized containers like milk gallons. The door bins tilt out to provide convenient storage for cans and other items.

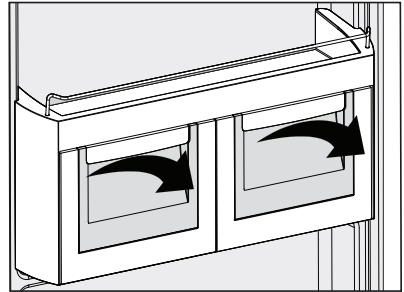

Condiment Shelf

The condiment shelf is designed to hold commonly used items such as mustards, jellies, seasonings and small jars.

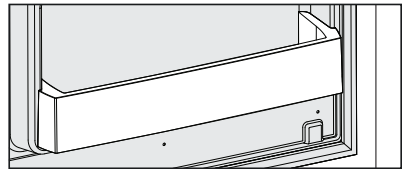

Ideas For Storing Foods

Fresh Food Storage

- Keep the fresh food compartment between 34° F and 40° F with an optimum temperature of 37° F.
- Avoid overcrowding the appliance shelves, which reduces air circulation and causes uneven cooling.

Fruits and Vegetables

Store fruits and vegetables in crisper drawers, where trapped moisture helps preserve food quality for longer time periods.

Meat

Wrap raw meat and poultry securely so leakage and contamination of other foods or surfaces does not occur.

Energy-Saving Ideas



- Locate the unit in the coolest part of the room, out of direct sunlight, and away from heating ducts or registers.

Do not place the unit next to heat-producing appliances such as a range, oven, or dishwasher. If this is not possible, a section of cabinetry or an added layer of insulation between the two appliances will help the unit operate more efficiently.

- Level the appliance so that the door closes tightly.
- Refer to the “SETTING THE TEMPERATURE CONTROL” section for the suggested temperature control settings.
- Do not overcrowd the unit or block cold air vents. Doing so causes the appliance to run longer and use more energy.
- Cover foods and wipe containers dry before placing them in the unit. This cuts down on moisture build-up inside the unit.
- Organize the appliance to reduce door openings. Remove as many items as needed at one time and close the door as soon as possible.

Vacation And Moving Tips

Short Vacations:

Leave the unit operating during vacations of less than three weeks.

Long Vacations:

If the appliance will not be used for several months:

- Remove all food and unplug the power cord.
- Clean and dry the interior thoroughly.
- Leave the door open slightly, blocking it open if necessary, to prevent odor and mold growth.

Moving: When moving the unit, follow these guidelines to prevent damage:

- Disconnect the power cord plug from the wall outlet.
- Remove foods, then defrost, and clean the appliance.
- Secure all loose items such as base panel, baskets, and shelves by taping them securely in place to prevent damage.
- In the moving vehicle, secure the unit in an upright position to prevent movement. Also protect outside of the appliance with a blanket, or similar item.

Care & Cleaning

Keep your unit clean to prevent odor build-up. Wipe up any spills immediately and clean at least twice a year. Never use metallic scouring pads, brushes, abrasive cleaners or strong alkaline solutions on any surface. Do not wash any removable parts in a dishwasher. Always unplug the electrical power.



CAUTION

- When moving the appliance pull straight out. Do not shift the unit from side to side as this may tear or gouge the floor covering.
- Damp objects stick to cold metal surfaces. Do not touch interior metal surfaces with wet or damp hands.

16 Care & Cleaning



CAUTION

- Turning the temperature control to “OFF” (See IQ Touch™ Electronic Control) turns off the compressor, but does not disconnect electrical power to the LED lights or other electrical components. Unplug the unit or switch the breaker that supplies power to the unit to the off position.
- Do not use razor blades or other sharp instruments which can scratch the appliance surface when removing adhesive labels. Any glue left from tape or labels can be removed with a mixture of warm water and mild detergent, or, touch the glue residue with the sticky side of tape you have already removed. Do not remove the serial plate.



NOTE

- Do Not use abrasive cleaners such as window sprays, scouring cleansers, flammable fluids, cleaning waxes, concentrated detergents, bleaches, or cleansers containing petroleum products on plastic parts, interior doors, gaskets, or cabinet liners. Do not use paper towels, scouring pads or other abrasive materials.
- Never use metallic scouring pads, brushes, abrasive cleaners or strong alkaline solutions on any surface.
- Do not wash any removable parts in a dishwasher.
- Always unplug the electrical power.

Care and cleaning tips

Part	Cleaning Agents	Tips and Precautions
Interior & Door Liners	<ul style="list-style-type: none">• Soap and water• Baking soda and water	<ul style="list-style-type: none">• Use 2 tbsp. (25 g) of baking soda in 1 qt. (1 l) warm water.• Be sure to wring excess water out of sponge or cloth before cleaning around controls, light bulb or any electrical part.
Door Gaskets	<ul style="list-style-type: none">• Soap and water	<ul style="list-style-type: none">• Wipe gaskets with a clean soft cloth.
Drawers & Bins	<ul style="list-style-type: none">• Soap and water	<ul style="list-style-type: none">• Use a soft cloth to clean drawer runners and tracks.• Do not wash any removable items (bins, drawers, etc.) in dishwasher.
Glass Shelves	<ul style="list-style-type: none">• Soap and water• Glass cleaner• Mild liquid sprays	<ul style="list-style-type: none">• Allow glass to warm to room temperature before immersing in warm water. Sudden temperature changes can cause glass breakage.
Toe Grille	<ul style="list-style-type: none">• Soap and water• Mild liquid sprays• Vacuum	<ul style="list-style-type: none">• Remove toe grille (see Installation Instructions).• Vacuum both sides and wipe with sudsy cloth or sponge. Rinse and dry.
Exterior & Handles	<ul style="list-style-type: none">• Soap and water• Non abrasive glass cleaner	<ul style="list-style-type: none">• Do not use commercial household cleaners containing ammonia, bleach or alcohol to clean handles.• Use a soft cloth to clean smooth handles.• Do not use a dry cloth to clean smooth doors.
Exterior & Handles (Stainless Steel Models Only)	<ul style="list-style-type: none">• Soap and water• Stainless steel cleaners	<ul style="list-style-type: none">• Never use CHLORIDE or cleaners with bleach to clean stainless steel.• Clean stainless steel front and handles with non-abrasive soapy water and a dishcloth. Rinse with clean water and a soft cloth.• Wipe stubborn spots with an ammonia-soaked paper towel, and rinse. Use a non-abrasive stainless steel cleaner. These cleaners can be purchased at most home improvement or major department stores. Always follow manufacturer's instruction.• NOTE: Always clean, wipe and dry with grain to prevent scratching.• Wash the rest of the cabinet with warm water and mild liquid detergent. Rinse well and wipe dry with a clean soft cloth.

Troubleshooting Guide

Before calling for service, review this list. It may save you time and expense. This list includes common occurrences that are not the result of defective workmanship or materials in this appliance.

Concern	Potential Cause	Common Solution
Appliance Operation		
Appliance does not run.	<ul style="list-style-type: none"> Appliance is plugged into a circuit that has a ground fault interrupt. Temperature control set to "OFF". Appliance may not be plugged in, or plug may be loose. House fuse blown or tripped circuit breaker. Power outage. 	<ul style="list-style-type: none"> Use another circuit. If you are unsure about the outlet, have it checked by a certified technician. See "Setting the IQ Touch™ Electronic Control" section. Ensure plug is tightly pushed into outlet. Check/replace fuse with a 15-amp time delay fuse. Reset circuit breaker. Check house lights. Call local Electric Company.
Appliance runs too much or too long.	<ul style="list-style-type: none"> Room or outside weather is hot. Appliance has recently been disconnected for a period of time. Large amount of warm or hot food have been stored recently. Door is opened too frequently or kept open too long. Door may be slightly open. Temperature control is set too low. Appliance gaskets are dirty, worn, cracked or poorly fitted. 	<ul style="list-style-type: none"> It's normal for the appliance to work harder under these conditions. It takes 24 hours for the appliance to cool down completely. Warm food will cause the appliance to run more until the desired temperature is reached. Warm air entering the appliance causes it to run more. Open the door less often. See "DOOR PROBLEMS". Set control to a warmer setting. Allow several hours for the temperature to stabilize. Clean gaskets (See Care and Cleaning Chart). Worn, cracked or poorly fitting gaskets should be replaced.
Interior temperature is too cold.	<ul style="list-style-type: none"> Temperature control is set too low. 	<ul style="list-style-type: none"> Set control to a warmer setting. Allow several hours for the temperature to stabilize.
Interior temperature is too warm.	<ul style="list-style-type: none"> Temperature control is set too warm. Door is opened too frequently or kept open too long. Door may be slightly open. Large amount of warm or hot food have been stored recently. Appliance has recently been disconnected for a period of time. 	<ul style="list-style-type: none"> Set control to a colder setting. Allow several hours for the temperature to stabilize. Warm air entering the appliance causes it to run more. Open the door less often. See "DOOR PROBLEMS". Wait until the appliance has had a chance to reach its selected temperature. Appliance requires 24 hours to cool down completely.
"LO" is displayed on control.	<ul style="list-style-type: none"> Control has been locked. 	<ul style="list-style-type: none"> Press the CONTROL LOCK key for three seconds to unlock.

18 Solutions to Common Problems

Concern	Potential Cause	Common Solution
“E7”, “E8”, “E9” is displayed on control.	<ul style="list-style-type: none"> The control has registered an error code. 	<ul style="list-style-type: none"> For toll-free telephone support in the U.S. and Canada: 1-877-4ELECTROLUX (1-877-435-3287)
“Sb” is displayed on control.	<ul style="list-style-type: none"> The control is in Sabbath Mode. 	<ul style="list-style-type: none"> Pressing the CONTROL LOCK and TEMP MODE keys to exit Sabbath Mode.
Sound & Noise		
Louder sound levels whenever appliance is on.	<ul style="list-style-type: none"> Modern appliances have increased storage capacity and more stable temperatures. They require heavy-duty compressors. 	<ul style="list-style-type: none"> This is normal. When the surrounding noise level is low, you might hear the compressor running while it cools the interior.
Louder sound levels when compressor comes on.	<ul style="list-style-type: none"> Appliance operates at higher pressures during the start of the ON cycle. 	<ul style="list-style-type: none"> This is normal. Sound will level off or disappear as appliance continues to run.
Popping or cracking sound when compressor comes on.	<ul style="list-style-type: none"> Metal parts undergo expansion and contraction, as in hot water pipes 	<ul style="list-style-type: none"> This is normal. Sound will level off or disappear as appliance continues to run.
Bubbling or gurgling sound.	<ul style="list-style-type: none"> Refrigerant (used to cool appliance) is circulating throughout the system. 	<ul style="list-style-type: none"> This is normal.
Vibrating or rattling noise.	<ul style="list-style-type: none"> Appliance is not level. It rocks on the floor when it is moved slightly. Floor is uneven or weak. Appliance is touching the wall. 	<ul style="list-style-type: none"> Level the appliance. Refer to the LEVELING section. Ensure floor can adequately support the appliance. Level the appliance by putting wood or metal shims under part of the appliance. Re-level appliance or move appliance slightly. Refer to the LEVELING section.
Water / Moisture / Frost Inside Refrigerator		
Moisture forms on inside appliance walls	<ul style="list-style-type: none"> Weather is hot and humid, which increases internal rate of frost buildup. Door is slightly open. Door is kept open too long or is opened too frequently. 	<ul style="list-style-type: none"> This is normal. See “DOOR PROBLEMS”. Open the door less often.
Odor In Appliance		
Odors in appliance.	<ul style="list-style-type: none"> Interior needs to be cleaned. Foods with strong odors are in the appliance. 	<ul style="list-style-type: none"> Clean interior with sponge, warm water, and baking soda. Replace air filter. Cover the food tightly.
Door Problems		
Door will not close.	<ul style="list-style-type: none"> Appliance is not level. It rocks on the floor when it is moved slightly. Floor is uneven or weak. 	<ul style="list-style-type: none"> This condition can force the cabinet out of square and misalign the door. Refer to the “LEVELING” section. Ensure floor can adequately support appliance. Level the appliance by putting wood or metal shims under part of the appliance.

Concern	Potential Cause	Common Solution
Lighting Problems		
Light bulb is not on.	<ul style="list-style-type: none"> • The LED or light bulb is burned out. • No electric current is reaching the appliance. • Control is in Sabbath mode (Sb is displayed on control) 	<ul style="list-style-type: none"> • Follow directions under “Luxury Design™ Lighting” in the “Air Filter and Luxury Design™ Lighting” section. • See “APPLIANCE DOES NOT RUN”. • Depress TEMP MODE key and CONTROL LOCK key for 3 seconds.

20 Major Appliance Warranty Information

Your appliance is covered by a one year limited warranty. For one year from your original date of purchase, Electrolux will repair or replace any parts of this appliance that prove to be defective in materials or workmanship when such appliance is installed, used, and maintained in accordance with the provided instructions. In addition, the cabinet liner and sealed refrigeration system (compressor, condenser, evaporator, dryer or tubing) of your appliance is covered by a two through five year limited warranty. During the 2nd through 5th years from your original date of purchase, Electrolux will repair or replace any parts in the cabinet liner and sealed refrigeration system which prove to be defective in materials or workmanship when such appliance is installed, used, and maintained in accordance with the provided instructions.

Exclusions

This warranty does not cover the following:

1. Products with original serial numbers that have been removed, altered or cannot be readily determined.
2. Product that has been transferred from its original owner to another party or removed outside the USA or Canada.
3. Rust on the interior or exterior of the unit.
4. Products purchased "as-is" are not covered by this warranty.
5. Food loss due to any refrigerator or freezer failures.
6. Products used in a commercial setting.
7. Service calls which do not involve malfunction or defects in materials or workmanship, or for appliances not in ordinary household use or used other than in accordance with the provided instructions.
8. Service calls to correct the installation of your appliance or to instruct you how to use your appliance.
9. Expenses for making the appliance accessible for servicing, such as removal of trim, cupboards, shelves, etc., which are not a part of the appliance when it is shipped from the factory.
10. Service calls to repair or replace appliance light bulbs, air filters, water filters, other consumables, or knobs, handles, or other cosmetic parts.
11. Pickup and delivery costs; your appliance is designed to be repaired in the home.
12. Surcharges including, but not limited to, any after hour, weekend, or holiday service calls, tolls, ferry trip charges, or mileage expense for service calls to remote areas, including the state of Alaska.
13. Damages to the finish of appliance or home incurred during transportation or installation, including but not limited to floors, cabinets, walls, etc.
14. Damages caused by: services performed by unauthorized service companies; use of parts other than genuine Electrolux parts or parts obtained from persons other than authorized service companies; or external causes such as abuse, misuse, inadequate power supply, accidents, fires, or acts of God.

DISCLAIMER OF IMPLIED WARRANTIES; LIMITATION OF REMEDIES

CUSTOMER'S SOLE AND EXCLUSIVE REMEDY UNDER THIS LIMITED WARRANTY SHALL BE REPAIR OR REPLACEMENT AS PROVIDED HEREIN. CLAIMS BASED ON IMPLIED WARRANTIES, INCLUDING WARRANTIES OF MERCHANTABILITY OR FITNESS FOR A PARTICULAR PURPOSE, ARE LIMITED TO ONE YEAR OR THE SHORTEST PERIOD ALLOWED BY LAW, BUT NOT LESS THAN ONE YEAR. ELECTROLUX SHALL NOT BE LIABLE FOR CONSEQUENTIAL OR INCIDENTAL DAMAGES SUCH AS PROPERTY DAMAGE AND INCIDENTAL EXPENSES RESULTING FROM ANY BREACH OF THIS WRITTEN LIMITED WARRANTY OR ANY IMPLIED WARRANTY. SOME STATES AND PROVINCES DO NOT ALLOW THE EXCLUSION OR LIMITATION OF INCIDENTAL OR CONSEQUENTIAL DAMAGES, OR LIMITATIONS ON THE DURATION OF IMPLIED WARRANTIES, SO THESE LIMITATIONS OR EXCLUSIONS MAY NOT APPLY TO YOU. THIS WRITTEN WARRANTY GIVES YOU SPECIFIC LEGAL RIGHTS. YOU MAY ALSO HAVE OTHER RIGHTS THAT VARY FROM STATE TO STATE.

If You Need Service

Keep your receipt, delivery slip, or some other appropriate payment record to establish the warranty period should service be required. If service is performed, it is in your best interest to obtain and keep all receipts. Service under this warranty must be obtained by contacting Electrolux at the addresses or phone numbers below.

This warranty only applies in the USA, Puerto Rico and Canada. In the USA and Puerto Rico, your appliance is warranted by Electrolux Major Appliances North America, a division of Electrolux Home Products, Inc. In Canada, your appliance is warranted by Electrolux Canada Corp. Electrolux authorizes no person to change or add to any obligations under this warranty. Obligations for service and parts under this warranty must be performed by Electrolux or an authorized service company. Product features or specifications as described or illustrated are subject to change without notice.

USA
1-877-435-3287
Electrolux Major Appliances North America
10200 David Taylor Drive
Charlotte, NC 28262

Canada
1-800-265-8352
Electrolux Canada Corp.
5855 Terry Fox Way
Mississauga, Ontario, Canada L5V 3E4