

Home Decorators

—Collection—











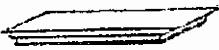











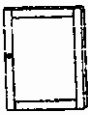







BF-21015 Hampton Bay Spacesaver Wood-Door

ASSEMBLY INSTRUCTIONS

Made In China-1A

Thank you for purchasing this quality product. Be sure to check all packing material carefully for small parts, which may have come loose inside the carton during shipment. Count all parts and material hardware. Compare with parts list to be sure all parts are present. If any parts are missing or damaged, phone, fax, or mail to our Customer Service Department. For efficient and speedy service please indicate the model number and code letter of part (s) need.

IMPORTANT NOTE: Follow instructions listed below in proper sequence as numbered to assure fast, easy and correct assembly.

PARTS LIST				
A  TOP PANEL-1PC	B  BELOW LEFT SIDE PANEL-1PC	C  BELOW RIGHT SIDE PANEL-1PC	D  ADORN PANEL-1PC	E  FIXED PANEL-1PC
F  ACROSS PANEL-1PC	G  SHELF-1PC	H  BACK PANEL-1PC	I  LOW PANEL-1PC	J  ACROSS PANEL-1PC
K  HP LEFT SIDE PANEL-1PC	N  HP RIGHT SIDE PANEL-1PC	M  RIGHT DOOR-1PC	L  LEFT DOOR-1PC	O  HINGE-4PCS
P  LARGE MAGNET-1PC	Q  CAM-LOCKS-24PCS	R  CAM-BOLTS-24PCS	S  KNOB-2PCS	T  SHELF SUPPORT-4PCS
U  FEMALE MAGNETS-2PCS	V  SCREWS-18PCS	W  SCREWS 26PCS	X  SCREWS-2PCS	Y  SCREWS-2PCS
Z  HANGER-2PCS	A1  CAM-TOOL-1PC	B1  HEXAGON WRENCH-1PC	C1  SCREWS-4PCS	D1  NUT-4PCS

NOTE: Upon opening thoroughly clean all woods surfaces with furniture polish to remove dust and dirt that may have settled onto finish during shipment .in order to protecting the product. Please assemble the product with at least two people.

1.) Assemble left/right side panel (B/C) and the fixed panel (E) and adorn panel (D) and the low panel(I).

Insert the nut (D1) into the low panel (I), Use the cam-tool (A1) rotate the cam-bolts(R) into the holes of left /right side panel (B/C) and attach the fixed panel (E) and adorn panel (D) and low panel (I). Then use the cam-tool (A1) tightens the cam-locks (Q) clockwise into holes of fixed panel (E) and adorn panel (D). Finally, use the hexagon wrench (B1) rotates the screws (C1) into the nuts (D1).(see the right picture).

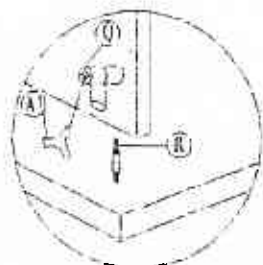

How to use CAM-TOOT

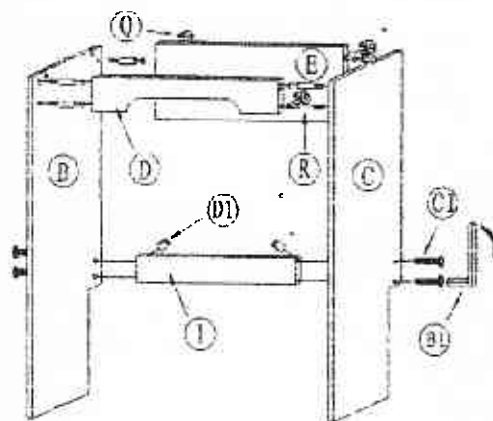

2.) Assemble across panel (F)..

Use the cam-tool (A1) rotates the cam-bolts (R) into the holes of across panel (F) and attach the side panel (B/C). Use the cam-tool (A1) tightens the cam-locks (Q) clockwise into the side panel (B/C). (See the left picture).

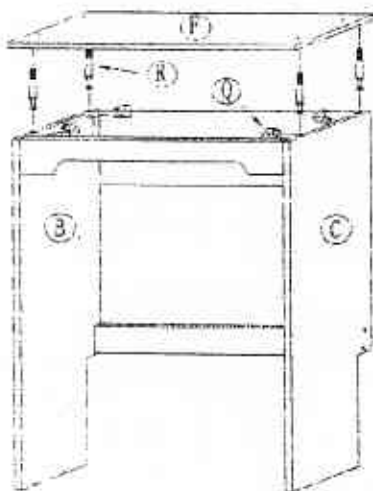

3.) Assemble the side panel (K/N) and across panel (J).

Use the cam-tool (A1) to rotate the cam-bolts (R) into the holes of side pane (K/N) and attach across panel (J), then use the cam-tool (A1) tighten the cam-locks (Q) clockwise into the holes of across panel (J). (See the right picture).

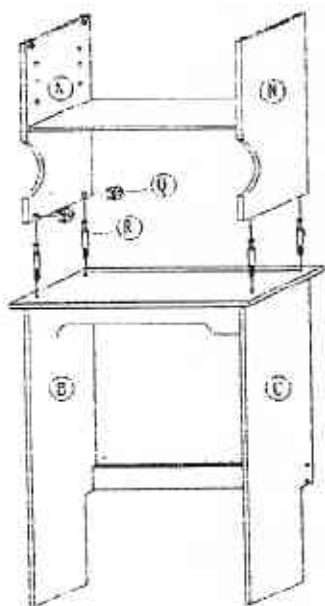
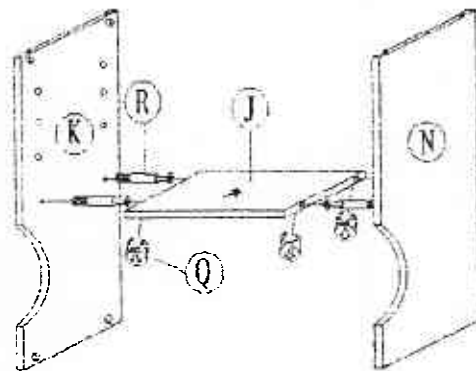

4.) Assemble the side panel (K/N)

Use the cam-tool (A1) to rotate the cam-bolts (R) into across panel (J) and attach the holes of side panel (K/N). Then use the cam-tool (A1) tightens the cam-locks (Q) clockwise into the holes of side panel(K/N). (See the left picture).

5.) Assemble the top panel (A).

Use the cam-tool (A1) rotate the cam-bolts (R) into the top panel (A) and attach side panel (K/N). Then use the cam-tool (A1) tightens the cam-lock (Q) clockwise into the hole of side panel (K/N). Finally, insert the shelf support (T) into the side panel (K/N) and rotate the screws (V) through the holes of large magnet (P) into the top panel (A). (See the right picture).

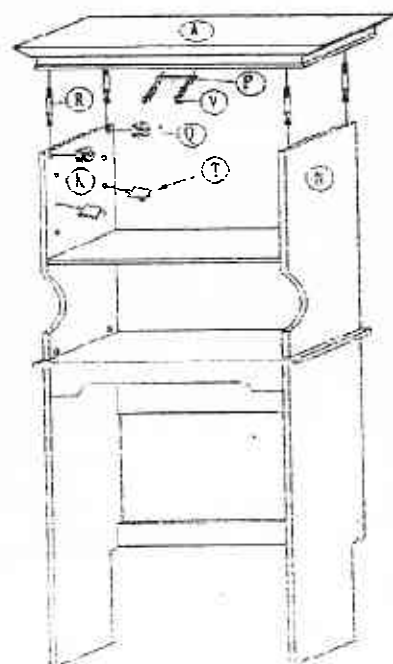

6). Ok Assembly the door (M/L) and the shelf (G). (See the right picture).

Rotate the screws (W) through the hole of hinge (O) into the holes of side panel (K/N) and the door (M/L). Rotate the screws (W) through the holes of female magnet (U) into the holes of door (M/L), then rotate the screws (Y) through the middle holes of door (M/L) into the knob (S). Finally, put the shelf onto the shelf support (T). (See the right picture).

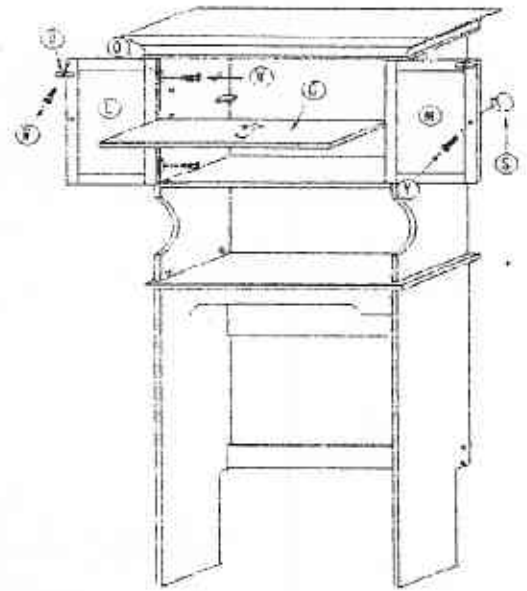

7), Assemble the back panel (H).

Rotate the screws (V) through the holes of back panel (H) into the side panel (K/N) and the top panel (A) and across panel (F/J). (See the below picture).

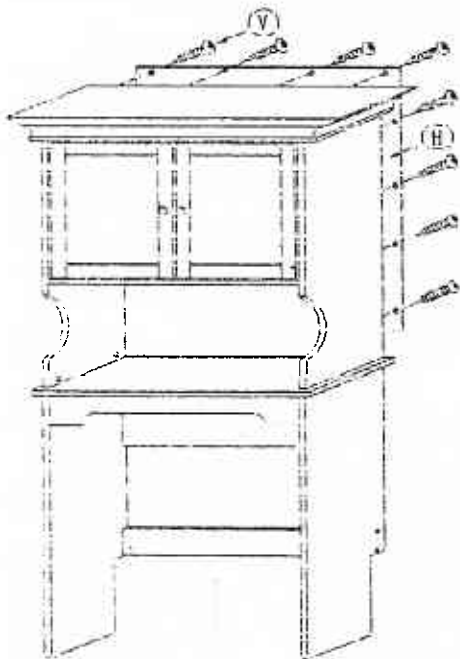

8.) Assemble Hanger (Z).

Start drilling two holes on the WALL it as between Left/Right Side Panel distance. Then put Hanger (Z) hit into wall and rotate and to tighten screw (X) into Hanger (Z). Put Cabinet hang up Screws (X). (See the right picture)

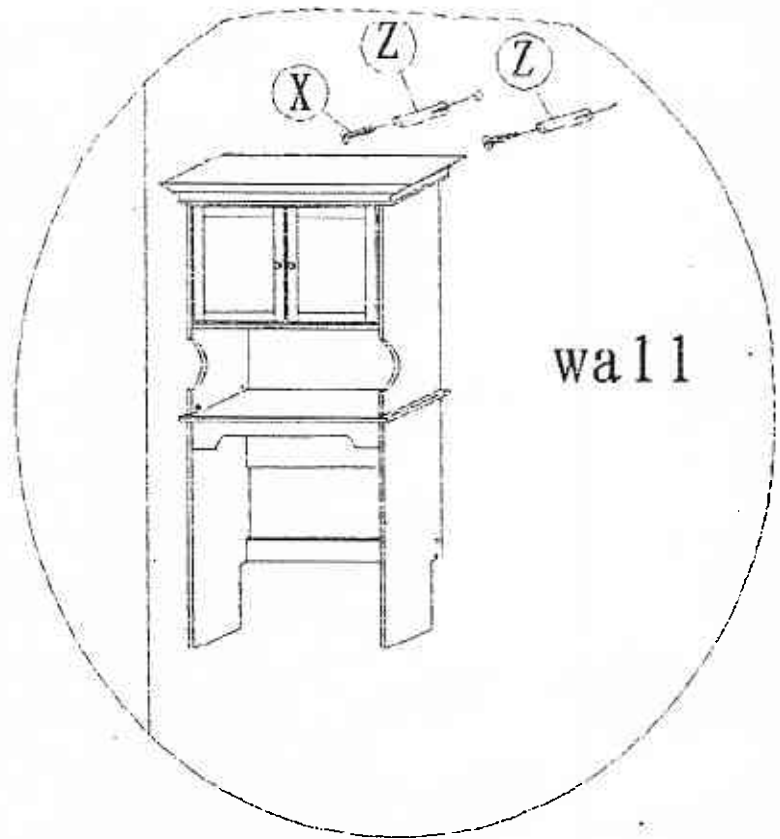

9). OK! (See the left picture).

