

Parts:

Letter	Name	QTY
A	Single screw side	1
B	Double screw side	1
C	Screws	17
D	Lower shelf	1
E	Shelve foot	1
F	Upper shelves	3

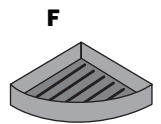

STEP 1

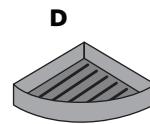
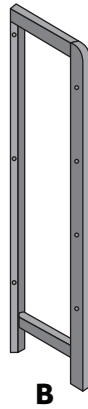
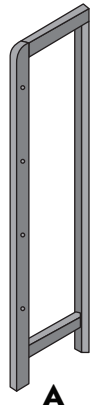
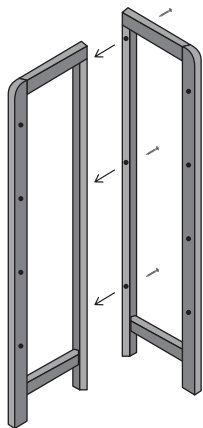

Using (3) **part C** screws attach **part B** to **part A**. Fasten securely but not too tight as to apply stress on the wood.

STEP 2

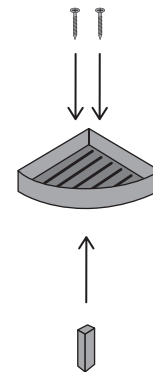

Attach **part E** to **Part D** using (2) **Part C** screws.

STEP 3

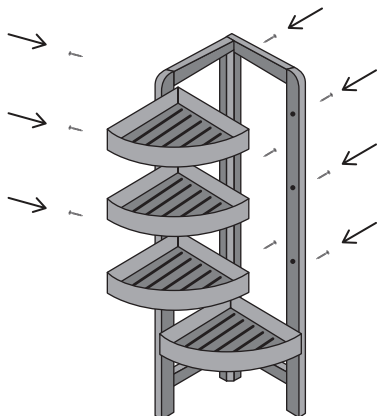

Attach the combination from **Step 2** and the (3) **Part F** shelves to the sides from **Step 1** with (12) **Part C** screws.
(8) **Part C** screws on the **B side** (4) on the **A side**.

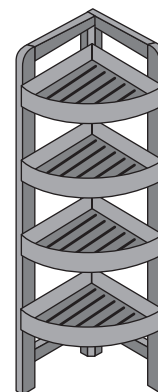

WE VALUE OUR CUSTOMERS AND WANT TO BE SURE YOU ARE SATISFIED WITH YOUR PRODUCT.
IF YOU HAVE ANY QUESTIONS OR CONCERNS OR YOU ARE NOT COMPLETELY SATISFIED, PLEASE CONTACT OUR OFFICE AT **1-800-906-1639**.