



# 48" SUPER JUMPER KIDS TRAMPOLINE

MODEL# 9008SJ  
PRODUCT MANUAL - VERSION 2.19.1

FOR AGES:

**3-10**

WEIGHT LIMIT:

**100** Lbs  
45 Kgs

TO BUILD:



TOOLS NEEDED:



**HOW-TO**  
VIDEOS ONLINE



## CUSTOMER SERVICE

GQBrands.com • CustomerService@GQBrands.com • 1-866-498-5269 • 4401 Samuell Blvd, Ste 150, Mesquite, TX 75149



# CUSTOMER SERVICE INFORMATION

Thank you for purchasing:

## 48-INCH SUPER JUMPER KIDS TRAMPOLINE

MODEL# 9008SJ

**If you have an issue with your item, do not return. Please report items that are damaged or missing parts to the manufacturer GQ Brands within three days of delivery. Contact customer service at customerservice@gqbrands.com or toll-free at 1-866-498-5269**

At GQBrands®, we want all of our customers to be completely satisfied with their purchase. Take time to review the contents of the product you have just received to make sure that all of the parts are included. If you find that any parts are missing or damaged, we will provide replacement parts at no charge within 30 days of purchase.

Please keep in mind that for select damaged part replacement requests, we will require a photo for submission.

To order these parts, or if you have any other questions or concerns about this GQBrands product, please contact us at

PureFun.Net  
GQBrands®  
Phone: 1-866-498-5269  
Email: CustomerService@GQBrands.com  
4401 Samuell Blvd, Ste 150,  
Mesquite, TX 75149

Please be sure to include the following information when you contact Customer Service:

**YOUR NAME:** \_\_\_\_\_

**YOUR MAILING ADDRESS:** \_\_\_\_\_

**YOUR EMAIL ADDRESS:** \_\_\_\_\_

**PRODUCT NAME:** \_\_\_\_\_

**PRODUCT MODEL#:** \_\_\_\_\_

**PART NUMBER** \_\_\_\_\_

**RETAILER WHERE PURCHASED:** \_\_\_\_\_

**DATE OF PURCHASE:** \_\_\_\_\_

**ORDER NUMBER: (If Available)** \_\_\_\_\_

**SERIAL NUMBER: (If Available)** \_\_\_\_\_

**QUANTITY NEEDED:** \_\_\_\_\_

**PICTURE OF DAMAGED PART**

## LIMITED WARRANTY

Global Quality Brands® warrants this product to be free from defects in workmanship and materials under normal use and conditions for a period of 90 DAYS FROM THE DATE OF ORIGINAL PURCHASE. This Limited Warranty is not transferable and is available only for the original purchaser of the Product. The Company's obligation under this warranty is limited to replacing or repairing the Product, at the discretion of the company.

All warranty coverage extends only to the original retail purchaser from the date of purchase, GQ Brands obligation under this warranty is limited to replacing or repairing, at Global Quality Brands® option. All products for which a warranty claim is made must be received by Global Quality Brands® and accompanied by sufficient proof of purchase (photocopy of the original store receipt, indicating the date of purchase). All freight and handling fees are the responsibility of the consumer to pay, both to and from Global Quality Brands®. All warranty claims must be preauthorized by Global Quality Brands® pre-authorization can be obtained by calling 866-498-5269.

This warranty does not cover ordinary wear and tear, weathering, failure to follow directions, improper installation, improper maintenance, or acts of nature, (such as damage caused by wind, lightning, snow, water, or ice) weather damage, damage caused by unauthorized repair work or damage caused by improper use of the products are not covered by the product warranty. No other warranty beyond that specifically set forth above is authorized by GQBrands®.

GLOBAL QUALITY BRANDS® IS NOT RESPONSIBLE OR LIABLE FOR INDIRECT, SPECIAL OR CONSEQUENTIAL DAMAGES ARISING OUT OF OR IN CONNECTION WITH THE USE OR PERFORMANCE OF THE PRODUCT OR OTHER DAMAGES WITH RESPECT TO ANY ECONOMIC LOSS, LOSS OF PROPERTY, LOSS OF REVENUE OR PROFITS, LOSS OF ENJOYMENT OR USE, COST OF REMOVAL, INSTALLATION OR OTHER CONSEQUENTIAL DAMAGES. SOME STATES DO NOT ALLOW THE EXCLUSION OR LIMITATION OF INCIDENTAL OR CONSEQUENTIAL DAMAGES. ACCORDINGLY,

THE ABOVE LIMITATION MAY NOT APPLY TO YOU. THE WARRANTY EXTENDED HEREUNDER IS IN LIEU OF ALL OTHER WARRANTIES AND GLOBAL QUALITY BRANDS®, SPECIFICALLY DISCLAIMS ANY IMPLIED WARRANTY OF MERCHANTABILITY OR FITNESS FOR A PARTICULAR PURPOSE IS LIMITED IN ITS SCOPE AND DURATION TO THE TERMS SET FORTH HEREIN. SOME STATES DO NOT ALLOW LIMITATION ON HOW LONG AN IMPLIED WARRANTY LASTS. ACCORDINGLY, THE ABOVE LIMITATION MAY NOT APPLY TO YOU. THIS WARRANTY GIVES YOU SPECIFIC LEGAL RIGHTS. YOU MAY ALSO HAVE OTHER RIGHTS, WHICH VARY FROM STATE TO STATE.

WHILE EVERY ATTEMPT IS MADE TO ENSURE THE HIGHEST DEGREE OF PROTECTION IN ALL EQUIPMENT, WE CANNOT GUARANTEE FREEDOM OF INJURY. THE USER ASSUMES ALL RISK OF INJURY DUE TO USE. ALL MERCHANDISE IS SOLD ON THIS CONDITION, WHICH NO REPRESENTATIVE OF GQBRANDS® CAN WAIVE OR CHANGE.

# WARNINGS

---



## **ADULT ASSEMBLY REQUIRED** **CHOKING HAZARD - Small Parts** **NOT** for children under 3 years of age.

**Please read these warnings and the information in this manual in its entirety.**

Failure to comply with the following instructions may increase the risk of serious injury and/or death:

---

- This unit must be assembled and disassembled by **ADULTS ONLY**.
- Children must be supervised at all times when using this equipment. **DO NOT** leave children unattended at any time.
- Children **MUST NEVER** use the trampoline unless supervised by a responsible adult with knowledge of trampoline use.
- This trampoline is suitable for use by most children between 3 and 10 years of age.
- **DO NOT** exceed the **MAXIMUM WEIGHT** limit of 100 Lbs (45 kgs) regardless of age.
- This trampoline is **NOT** for adult use.
- The trampoline handle is only intended to assist your child with controlling their bounce and maintaining their balance on the mat. The handle should **NOT** be used for any other purpose or as a climbing feature.
- This trampoline is only designed for normal residential indoor use. It is **NOT** intended for commercial applications and/or in public areas such as schools, parks, nurseries, day schools, day cares, etc. For **INDOOR USE ONLY**: Your trampoline should be placed at a safe distance from any obstructions, stairways, windows, furniture, appliances, etc.
- **DO NOT** allow more than one person on the trampoline at a time.
- **DO NOT** wear glasses or helmets when using the trampoline.
- **DO NOT** fall or bounce on your knees -- this can cause injury.
- **DO NOT** somersault — this can cause serious injury, including paralysis or death.
- **DO NOT** allow other persons to go under, sit, stand or lie on or near the frame pads or mat while the trampoline is in use.
- **NEVER** store items or playthings under the trampoline.
- **ALWAYS** secure this trampoline against unauthorized and/or unsupervised use.
- **DO NOT** use or allow use of the trampoline under the influence of any substance or medication which may impair the supervisor's or jumper's judgment and/or coordination.
- Mount and dismount the trampoline with care as injury may result.
- **ALWAYS** remove jewelry, belt buckles, or any other sharp objects before using the trampoline.
- **ALWAYS** jump in the middle of the trampoline bed.
- You should only use the included T-Hook Spring Tool to attach the Springs. Work gloves are recommended to be worn when attaching the Springs to protect against pinch points.
- Before each use of this product, carefully inspect it and replace any worn, defective or missing parts. Although the springs, pad, foam and mat are made to take a lot of wear, over time these parts may need to be replaced.
- The construction of this trampoline uses hardware which may need to be re-tighten in certain cases. It is important to check the trampoline periodically to ensure the frame is steady and all parts are in good condition.
- **ALWAYS** make sure that the bolt ends are covered by the included Safety Caps. If a Safety Cap is missing, the bolt ends should be sufficiently covered with another protective device before use by a child is allowed.
- Please read and refer to other warnings and use information in the trampoline instructions before use.
- Please read and refer to other warnings and use information in the Safe Play Tips before use.
- Dispose of all packaging materials safely and per local ordinance.

# PARTS LIST

1 - Top Rail

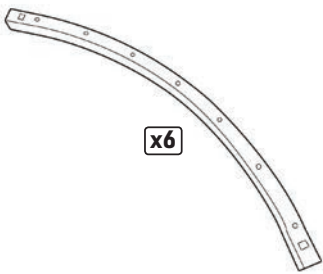

2 - T-Joint

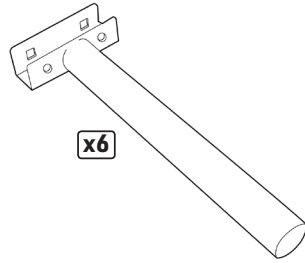

3 - N/A

Not available in this version

4 - Leg Cap



5 - Jump Mat with Mesh

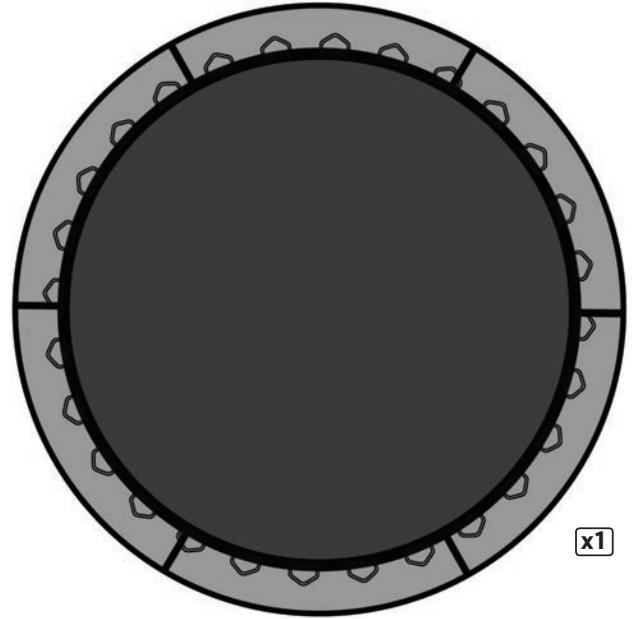

6 - Frame Pad

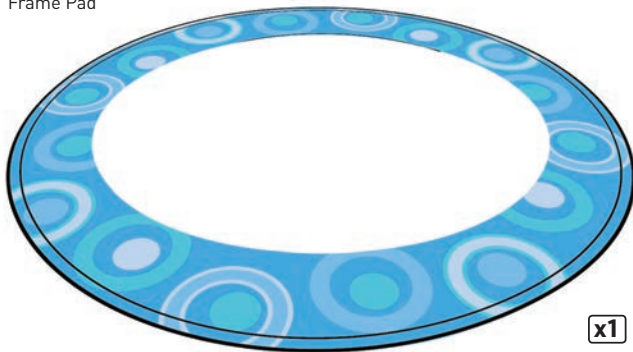

7L - Hand Rail Base - Left

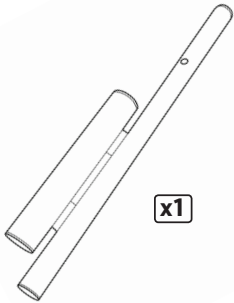

7R - Hand Rail Base - Right



8 - Side Hand Rail

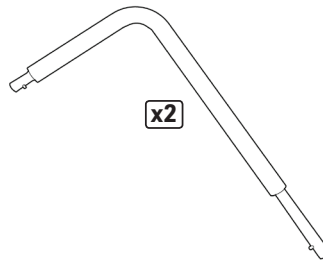

9 - Center Hand Rail

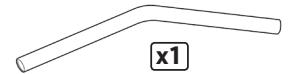

10 - Bolt

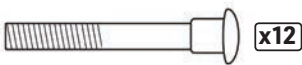

11 - Hex Nut



12 - Safety Nut Cap



13 - Plastic Washer



14 - Spring

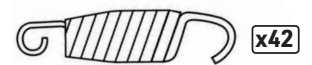

15 - Wrench

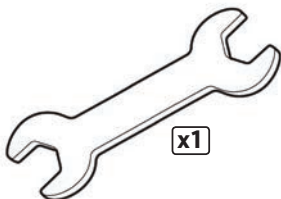

16 - T-Hook Spring Tool



# ASSEMBLY INSTRUCTIONS

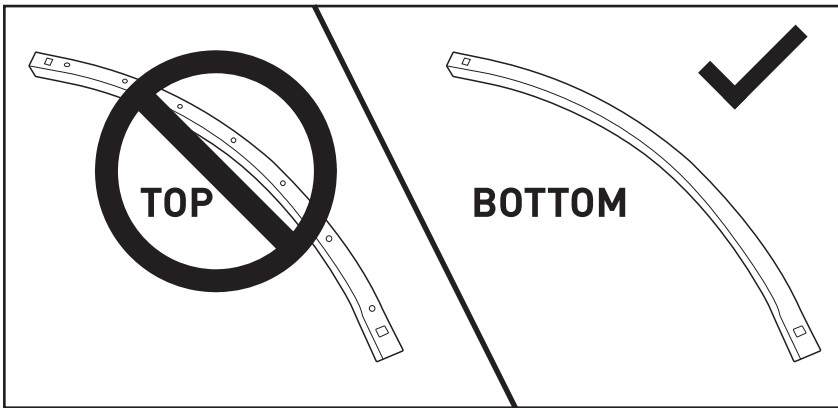

**NOTE:**

Make sure that you assemble the T-Section/Legs to the Top Rail as shown to be certain that the pre-drilled spring holes are facing in the correct direction when you attach the springs.

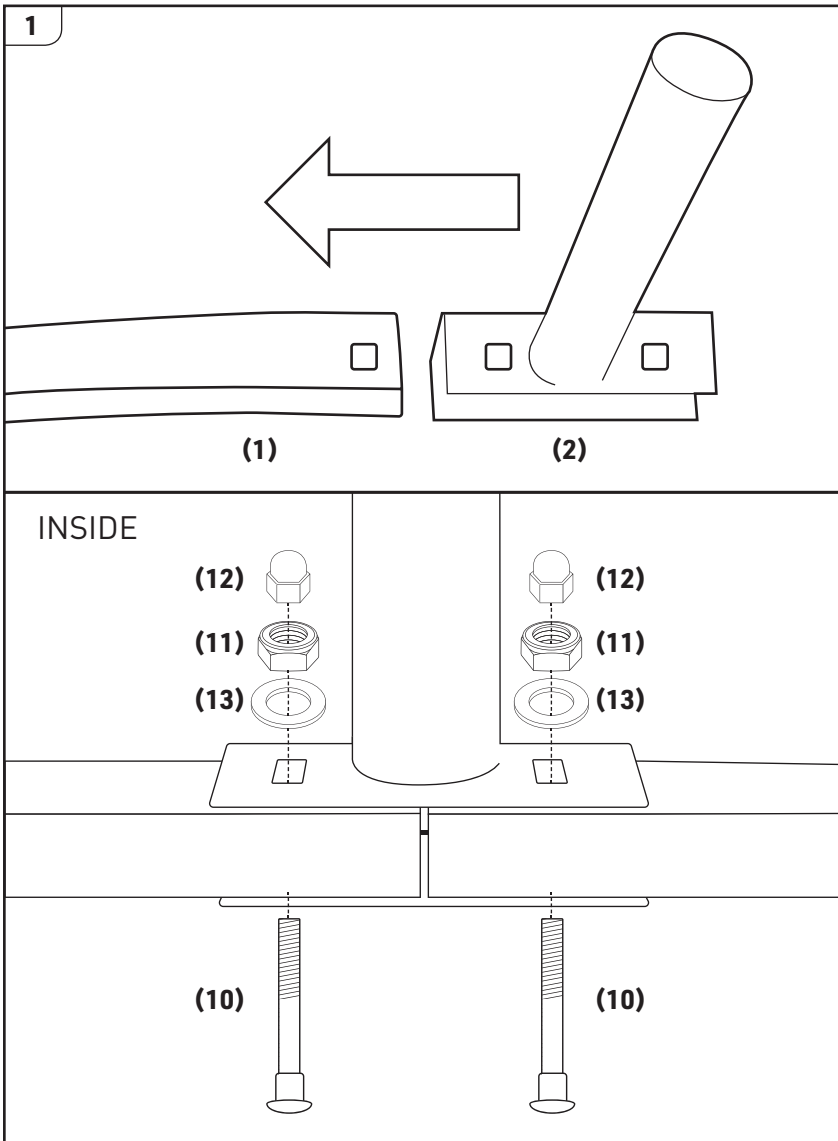

**STEP 1:**

A. Slide a T-Joint (Part 2) onto the end of a Top Rail (Part 1). Next, slide the end of another Top Rail into this T-Section so that each Top Rail can be bolted to one side of the T-Section.

**NOTE:**

Make sure that the Solid Edge of the T-Section is facing away from the center of the circle for each Top Rail Section.

B. Fasten the T-Joint to the Top Rails using 2x Bolts (Part 10), 2x plastic Washers (Part 13), and 2x Hex Nuts (Part 11).

**NOTE:**

Do not fully tighten the bolts until all Top Rails are connected.

Repeat these steps with all Top Rails and all T-Joints to form the Top Rail Frame.

Once the Top Rail Frame has been formed, tighten all hex nuts and place 12x Safety Nut Caps (Part 12)

# ASSEMBLY INSTRUCTIONS

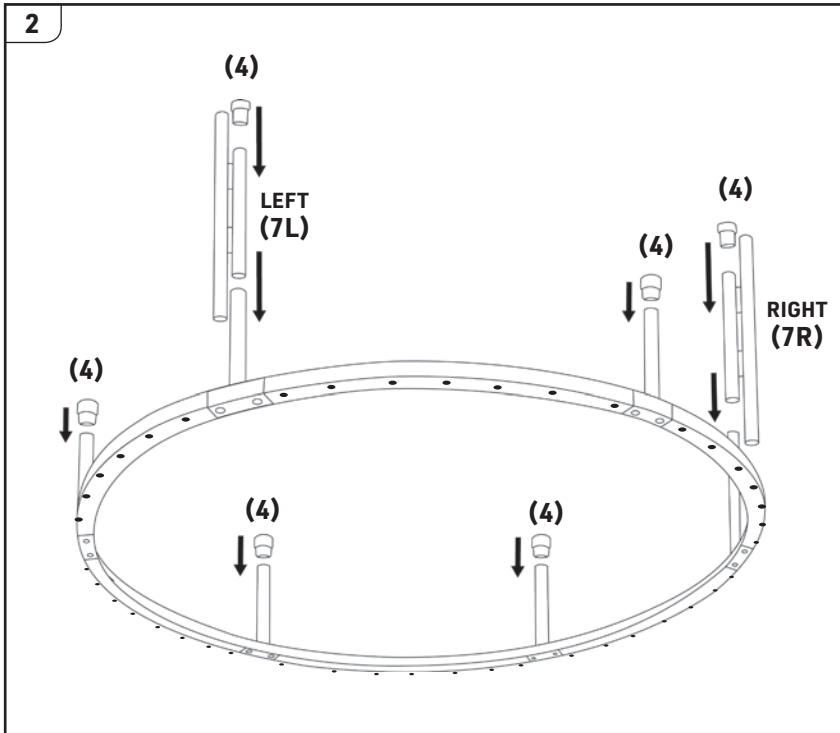

## STEP 2:

Slide 1x Hand Rail Base - Left (Part 7L) and slide 1x Leg Cap (Part 4) into a T-Joint to secure it.

Then Slide 1x Hand Base Rail - Right (Part 7R) one leg apart from the Left side as shown on to a T-Joint, and secure with 1x Leg Cap (Part 4).

## NOTE:

The Hand Rail Bases (Parts 7L & 7R) need to have one leg in between to be able to have enough distance to connect.

Place the remainder of the Leg Caps on the rest of the T-Joints.

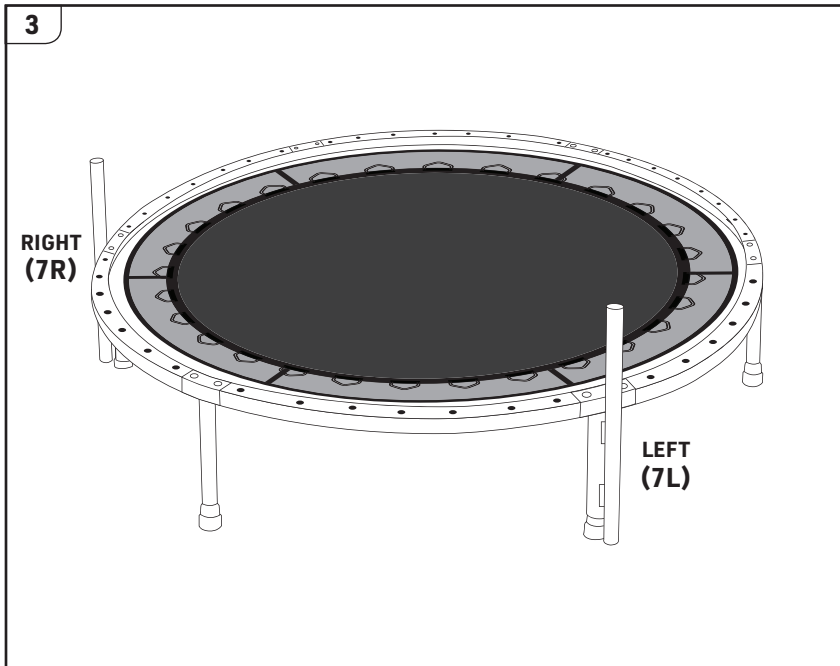

## STEP 3:

Flip the trampoline over to stand on its own

Lay out the Jump Mat with Mesh (Part 5) in the center of the frame with the Logo facing up.

# ASSEMBLY INSTRUCTIONS

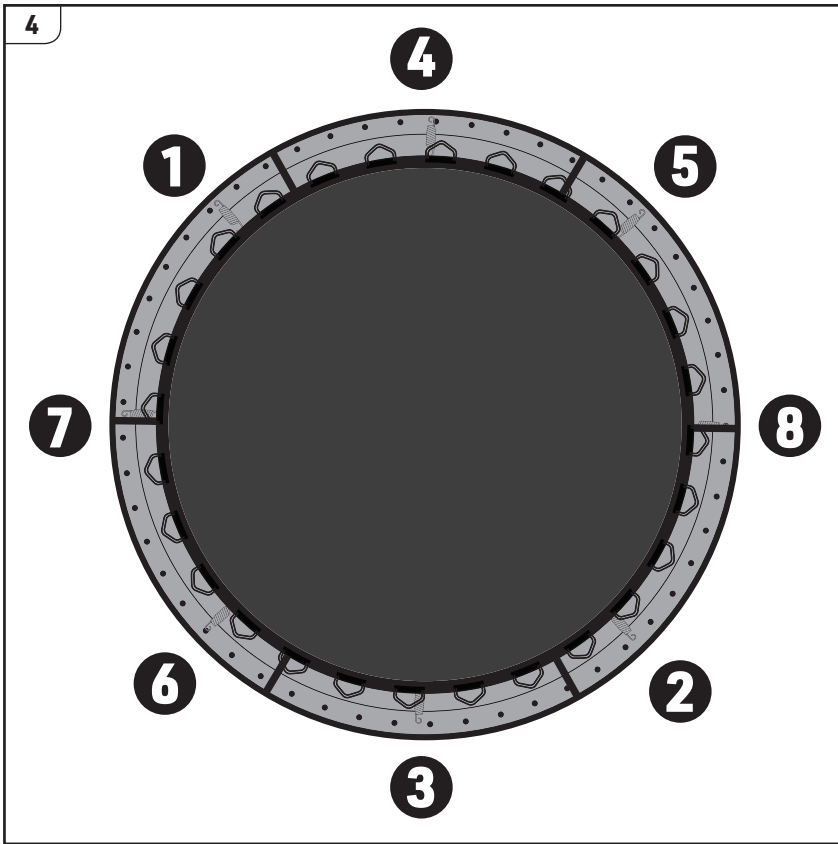

## STEP 4:

Using the T-Hook Spring Tool (Part 16), attach eight initial springs (Part 14) directly across from each other at "compass points" as shown.

## NOTE:

Only use the T-Hook Spring Tool included with this product to attach the springs. NEVER use your hands only or other household tools to attach these springs.

We suggest that you count the V-rings on the mat as they line up to the holes in the top rail before continuing.

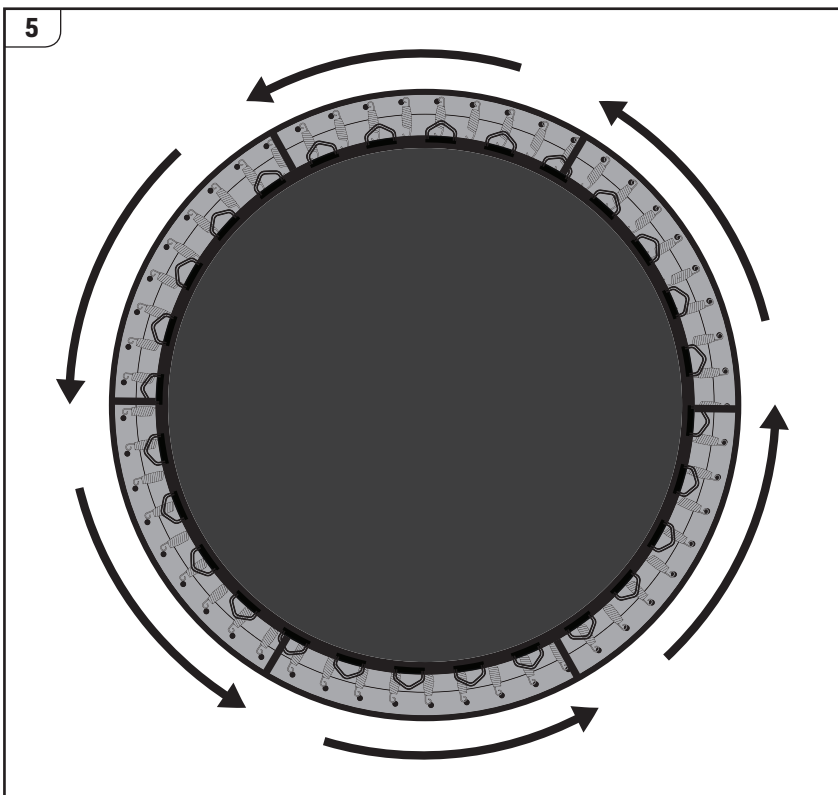

## STEP 5:

Once the initial 8 springs have been attached to their corresponding V-rings and openings on the Top Rail, attach the remainder of the springs (Part 14) in clockwise order from current springs.

## NOTE:

If you see that the Jumping Mat looks uneven, make sure to locate the proper V-Rings on the Mat to the correct Spring to avoid excessive pressure on the Mat.

# ASSEMBLY INSTRUCTIONS

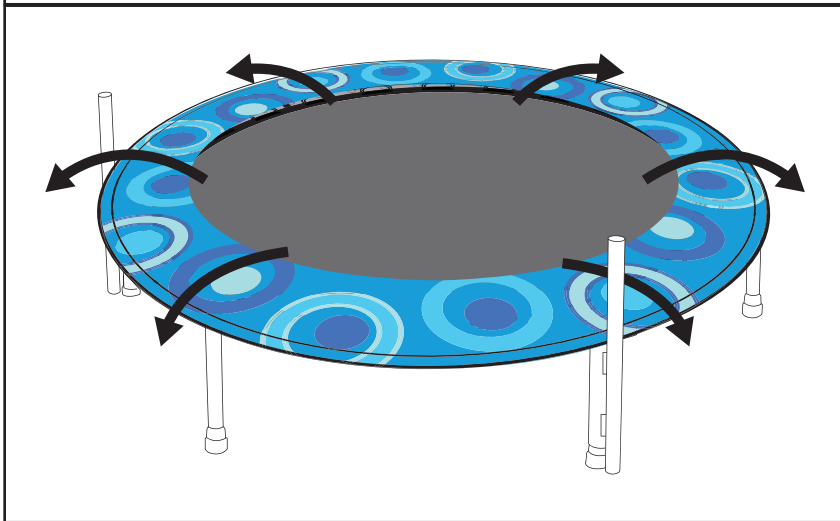
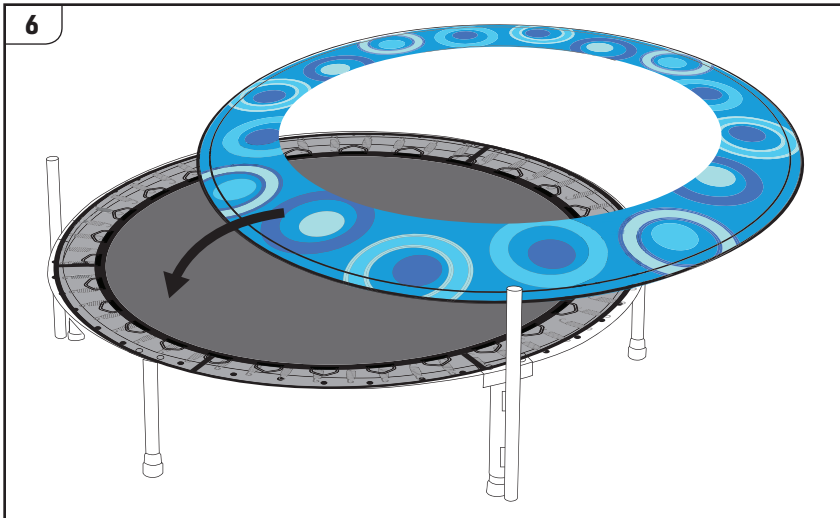

## STEP 6:

Place the Frame Pad (Part 6) on top the Jumping Mat.

Stretch the Frame Pad so it completely covers all Springs and the Mesh of the Jumping Mat.

## NOTE:

Make sure all springs are completely covered to avoid any injury while in use.



# ASSEMBLY INSTRUCTIONS

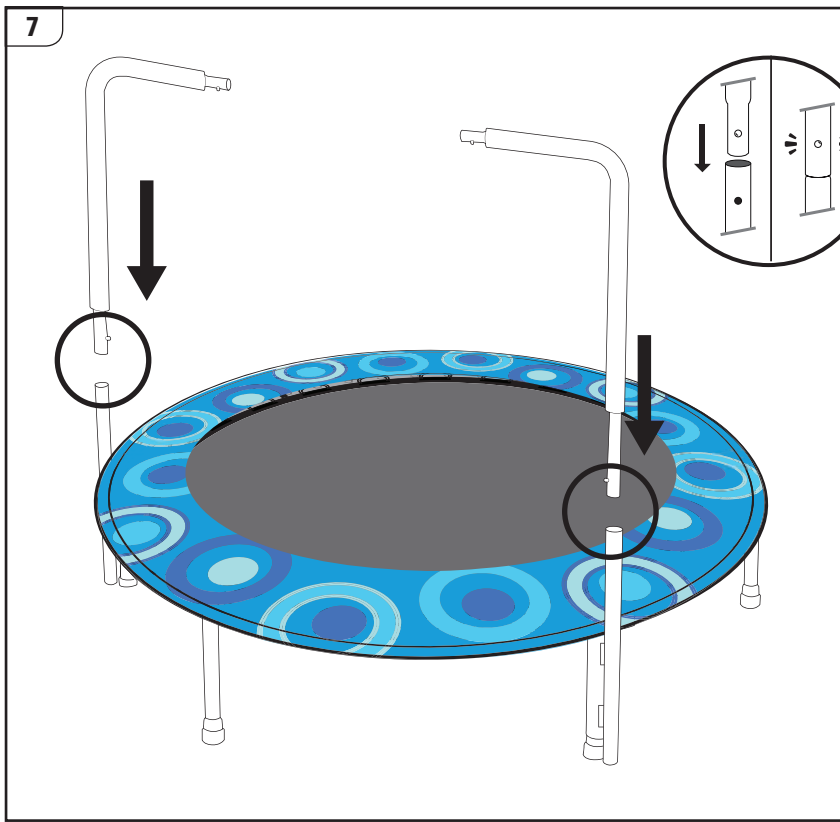

## STEP 7:

Attach 2x Side Hand Rails (Part 8) by placing the end into the Hand Rail Base.

Secure with the push pins buttons located on the Hand Rails. Make sure that the push buttons are fully secure in the Hand Rail Base.

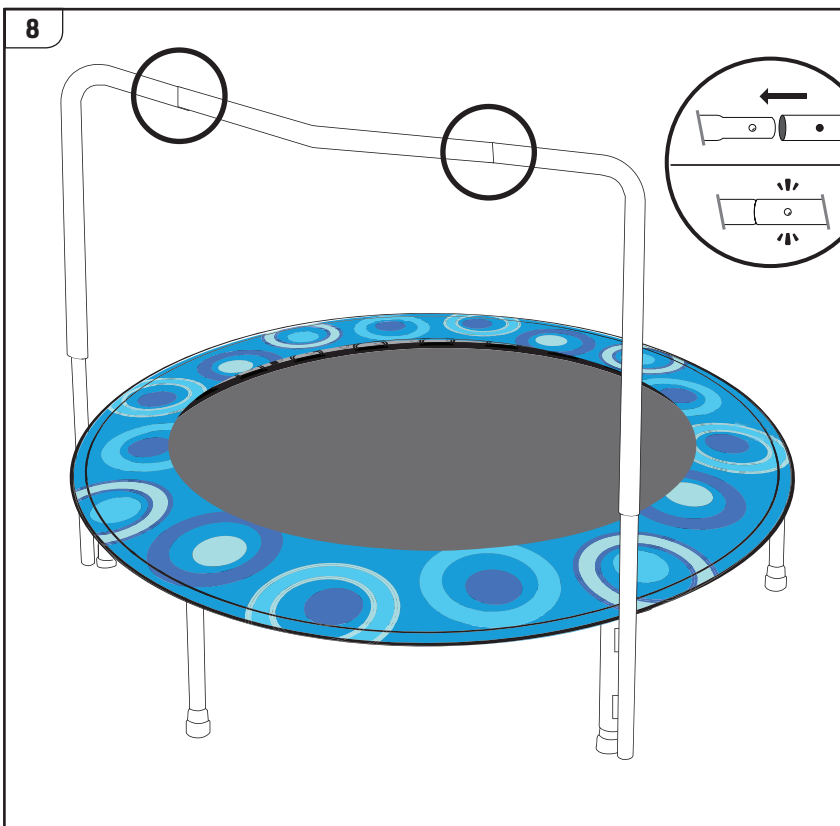

## STEP 8:

Secure the Center Hand Rail (Part 9) by attaching it to the Side Hand Rails as shown. Secure with the push pin buttons located in the Hand Rails.

Make sure this connection is secure before continuing.

---



---



---



---



---



---



---



---



---



---



---



---



---



---



---



---



---



---



---



---



---



---



---



---



---



---

**GQBrands®**  
 1-866-498-5269  
 CustomerService@GQBrands.com  
 4401 Samuell Blvd, Ste 150,  
 Mesquite, TX 75149