

IMPORTANT INSTRUCTION

1. Install the blade assembly.

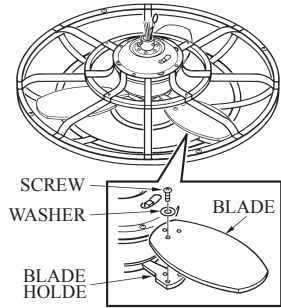

2. Install the canopy, decorative scroll set.

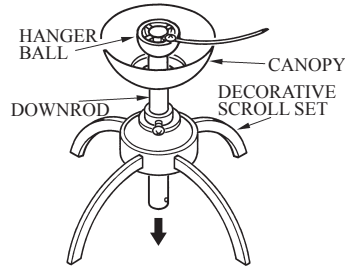

3. Install the downrod.

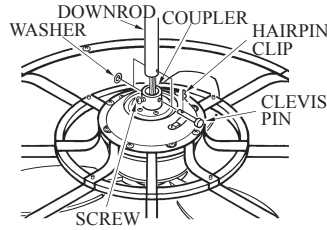

4. Install the scroll assembly to the fan.

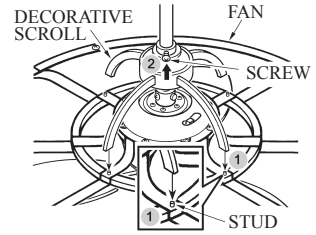

5. Install the hanger bracket.

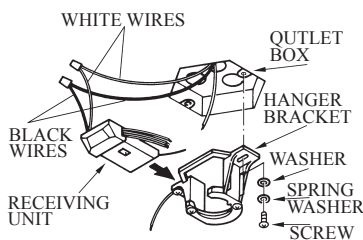

6. Lift the fan on the hanger bracket.

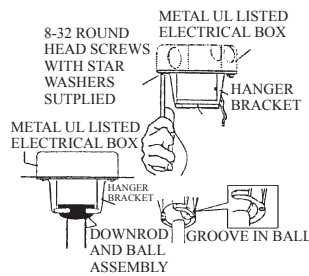

7. Install the receiving unit into hanger bracket.

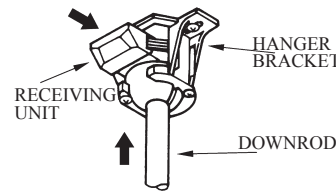

8. Secure the safety cable.

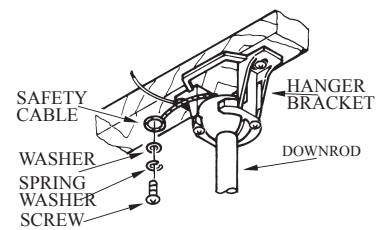

9. Wire connections.

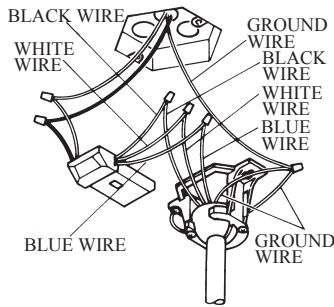

10. Install the canopy.

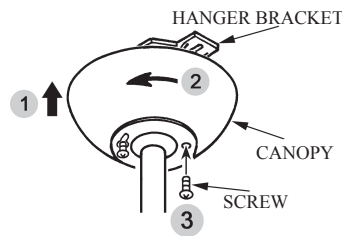

11. Secure the safety cable and re-install the cable.

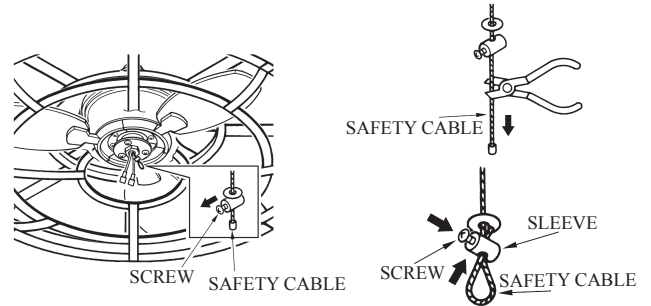

12. Install the light kit plate holder.

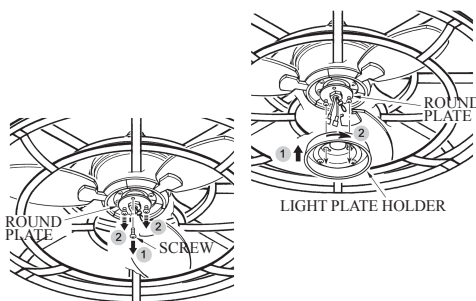

13. Install the light kit plate.

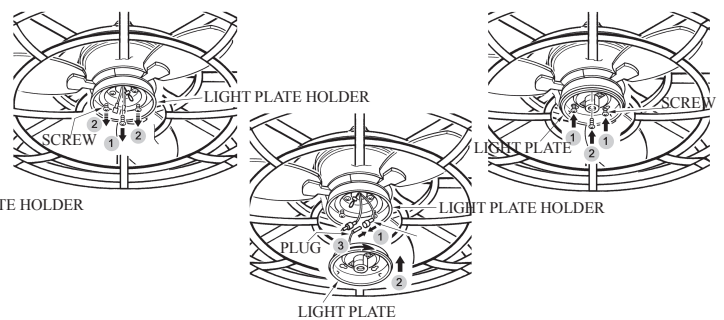

14. Install the light bulbs.

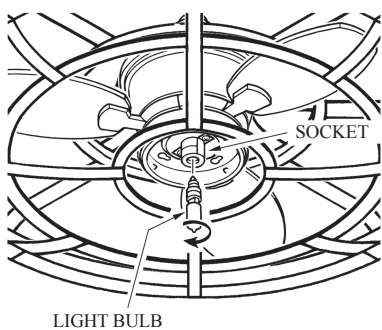

15. Install the glass shade.

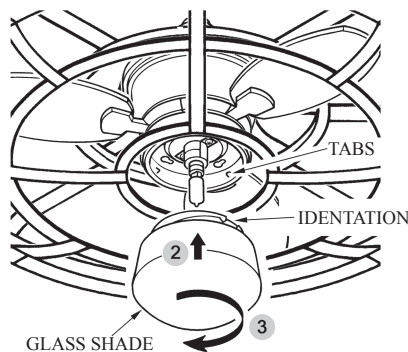

16. Operate the reverse switch for airflow.

