



# 8x4 SpaceSaver Garden Shed Bevel Model Assembly Manual

Revision #22  
May 22, 2019

Thank you for purchasing an 8x4 SpaceSaver Garden Shed. Please take the time to identify all the parts prior to assembly.

Please be aware that it is the customers' sole responsibility to acquire the necessary building permits and or obtain approval from their local county, municipality or HOA prior to purchasing. Generally, shed structures under 100 square feet do not require permits in most jurisdictions in the United States and Canada.



**In the event of a missing or broken piece, simply call the Outdoor Living Today Customer Support Line @ 1-888-658-1658 within 30 days of the delivery of your purchase. It is our commitment to you to courier replacement parts, free of charge, within 10 business days of this notification. Replacement parts will not be provided free of charge after the 30 day grace period.**

Thank you for purchasing our 8x4 Bevel SpaceSaver Garden Shed.  
Please take the time to identify all the parts prior to assembly.

## Parts List:

### A. Floor Section

- 1 - 45 1/2" x 75" - **Large Floor Frame** (2 Joists unattached)
- 1 - 45 1/2" x 21" - **Small Floor Frame** (2 Joists ATTACHED)
- 2 - 1 1/2" x 3 1/2" x 72" - **Floor Joists**  
(Steps 1 - 2)

- 5 - 1 1/2" x 3 1/2" x 45 1/2" - **Floor Runners**  
(Steps 3 - 5)

- 1 - 5/8" x 45 1/2" x 75" - **Plywood Flooring**
- 1 - 5/8" x 45 1/2" x 21" - **Plywood Flooring**  
(Steps 6 - 8)

### B. Wall Section

- 4 - 1 1/2" x 2 1/2" x 45 1/2" - **Wall Plates**
- 4 - 45 1/2" x 75" - **Solid Wall Panels**
- 1 - 45 1/2" x 75" - **Window Wall Panel**
- 1 - 12" x 73" - **Narrow Wall Panels**  
(Steps 9 - 18)

- 1 - 2" x 3 1/2" x 45 1/2" - **Door Header - (Dado top edge)**
- 2 - 3/4" x 3 1/2" x 73" - **Door Jambs - Vertical**  
(Steps 19 - 21)

- 2 - **Top Triangular Siding Pc for Angle Wall Extensors (L/R)**
- 2 - 45 1/4" - **Angle Wall Extensors (L/R)**
- 2 - 9" x 45 1/2" - **Wall Extensors**  
(Steps 22 - 28)

- 1 - 3/4" x 3 1/2" x 70" - **Horizontal Wall Cleat**
- 1 - 3/4" x 3 1/2" x 21" - **Horizontal Wall Cleat**  
(Step 29-30)

### C. Rafter & Roof Section

- 6 - 1 1/2" x 2 1/2" x 54" - **Rafters**
- 2 - 1/2" x 3 1/2" x 48" - **Front Soffit**
- 2 - 1/2" x 3" x 48" - **Rear Soffit**  
(Steps 31 - 36)

- 2 - **Rafter/Facia Nailing Plates** - 3/4" x 3/4" x 48"  
(Step 37)

- 2 - **Roof Panels** - 51" w x 56" d (1 - Left 1- Right)  
(Steps 38 - 40)

- 4 - 5 1/2" Wide x 16" to 18" long - **Filler Shingles**  
(Steps 41 - 44)

### D. Miscellaneous Section

#### (Skirting, Trim, Door, Facia & Misc. Parts)

- 6 - 3/4" x 4 1/2" x 45 1/4" - **Bottom Skirting** (Bevel Siding)  
(Steps 47 - 50)

- 8 - 7/8" x 2 1/2" x 36" - **Corner Filler Trims**
- 2 - 7/8" x 2 1/2" x 10" - **Rear Center Corner Filler Trims**  
(Steps 51 - 53)

- 2 - 1/2" x 3 1/2" x 79" - **Vertical Door Trims**
- 1 - 3/4" x 1 1/2" x 45 1/4" - **Top Window Wall Trim**  
(Steps 54 - 56)

- 2 - 1/2" x 5 1/2" x 79" - **Front Corner Trims**
- 2 - 1/2" x 5 1/2" x 88 3/4" - **Rear Corner Trims**
- 2 - 1/2" x 2 1/2" x 80" - **Side Front Corner Trims**
- 3 - 1/2" x 2 1/2" x 88 3/4" - **Side Rear Corner & Middle Trims**  
(Steps 57 - 59)

- 1 - 31 1/2" x 72" - **Full Door**  
(Step 60-64)

- 1 - 1/2" x 1 1/4" x 32" - **Above Door Trim**
- 1 - 1/2" x 2 1/2" x 7 3/4" - **Narrow Wall Trim**  
(Step 65)

- 2 - 1/2" x 4" x 54 1/8" - **Side Facia** (Angle Cut Ends) - reverse
- 4 - 1/2" x 4" x 50 1/2" - **Front and Rear Facia**  
(Steps 66 - 68)

- 2 - 1/2" x 4 1/2" x 51 5/8" - **Roof Ridge Boards**  
(Step 69)

- 2 - **Detail Facia Plates** (4" high)  
(Step 70)

- 1 - 1/2" x 1/2" x 32" - **Upper Hor. Door Stop**
- 2 - 1/2" x 1/2" x 36 1/4" - **Vertical Door Stops**  
(Steps 71 - 72)

- 1 **Aluminum Window Insert**  
(Steps 73 - 74)

#### Window Trim Pkg

- 1 - 24 1/16" angle cut / 3 - 23" Straight Cut - **Window Trim Kit**  
(Steps 75)

- 1 **Flower Box Kit**  
(Steps 76)

- 1 - 45 1/4" - **Extra Piece of Bevel Wall Siding** - Use if wall panel siding is damaged or to shim floor or door.

#### Optional Pieces - When Door configured on end.

- 1 - 1 1/2" x 3 1/2" x 73" - **Optional Door Jamb**
- 1 - 1/2" x 2 1/2" x 79" - **Optional Vertical Door Trim**  
(Optional - Steps 79 - 82)

Note: All Trim, Facia and Bottom Skirting pieces will be positioned rough face out when installed.

# 8x4 BEVEL SPACESAVER HARDWARE PACKAGE

## Hardware Kit (Provided)

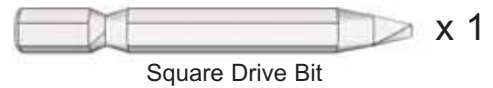
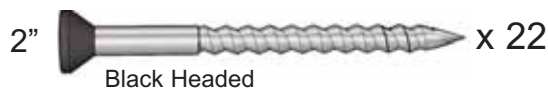

## Tools Required (Not Provided)



## Safety Equipment Required (Not Provided)



# A. Floor Section

Exploded view of all parts necessary to complete Floor Section. Identify all parts prior to starting. Note: Floor Footprint is 96" wide x 45 1/2" deep.

## Exploded Floor Section

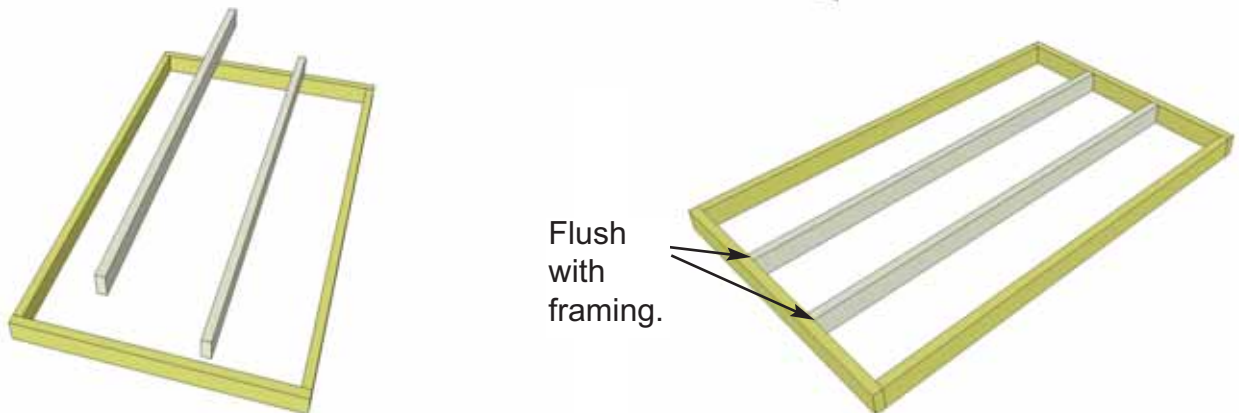
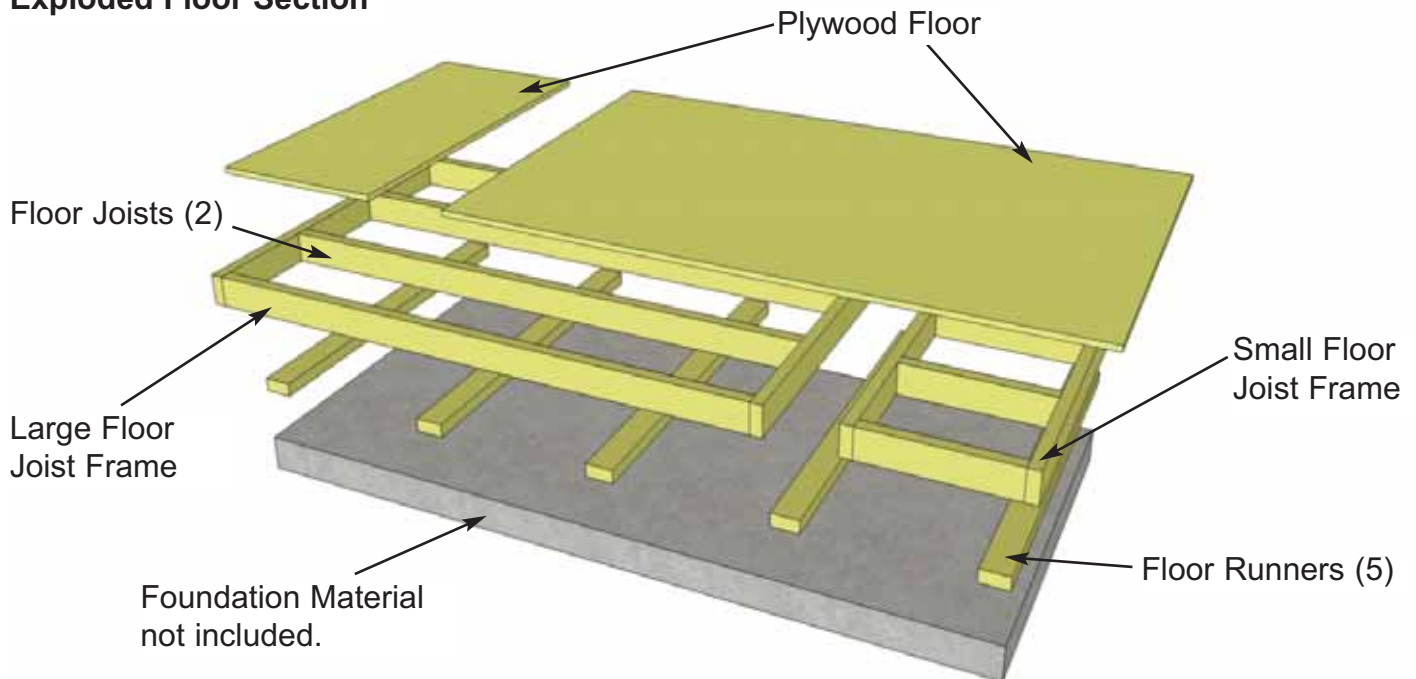

**1.** Lay out **Large Floor Joist Frame** and **2 Floor Joists** (1 1/2" x 3 1/2" x 72") as illustrated above. Position Joists equally in Floor Joist Frame. Use **Small Floor Joist Frame** as a template to determine joist position. Position Joist so flush with framing.



**2.** When correctly positioned, attach each Joist with 4 - 2 1/2" screws (2 per end). **You can find the Square Drive Bit for the screws in with the Hardware Kit Bag.**

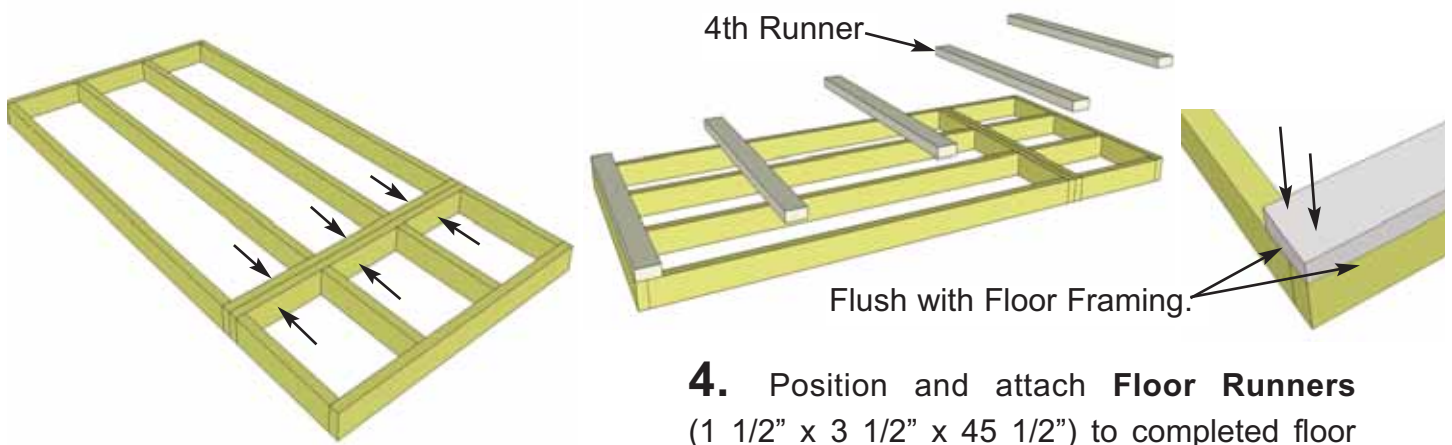

**3.** With Floor Joist Frames positioned together flush, attach with 6 - 2 1/2" screws.

**4.** Position and attach **Floor Runners** (1 1/2" x 3 1/2" x 45 1/2") to completed floor frames with 6 - 2 1/2" screws per Runner. Make sure Runners are flush with outside of floor framing but not overhanging. Make sure 4th Runner is placed equally over seam where floor frames meet.

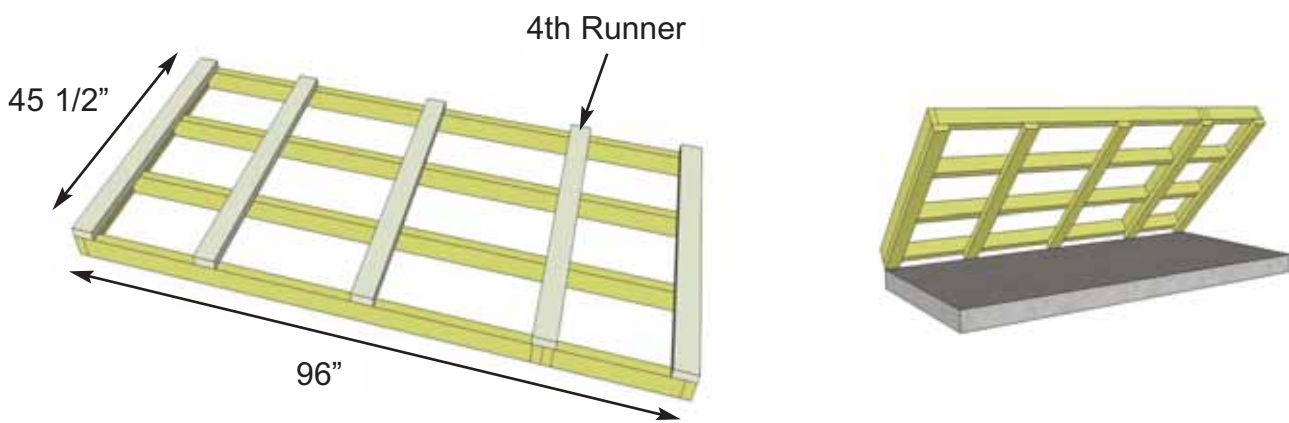

**5.** With Floor Runners attached, carefully flip the floor over and place on your foundation. **Caution** - you may need 2 people to assist you. Be careful when laying floor down not to bend or twist floor. **Note:** The floor will be flipped over and floor runners will sit on your foundation. It is important to note that having a level foundation is critical. Choosing a foundation will vary between regions. Typical foundations can be concrete pads or patio stones positioned underneath the floor runners.

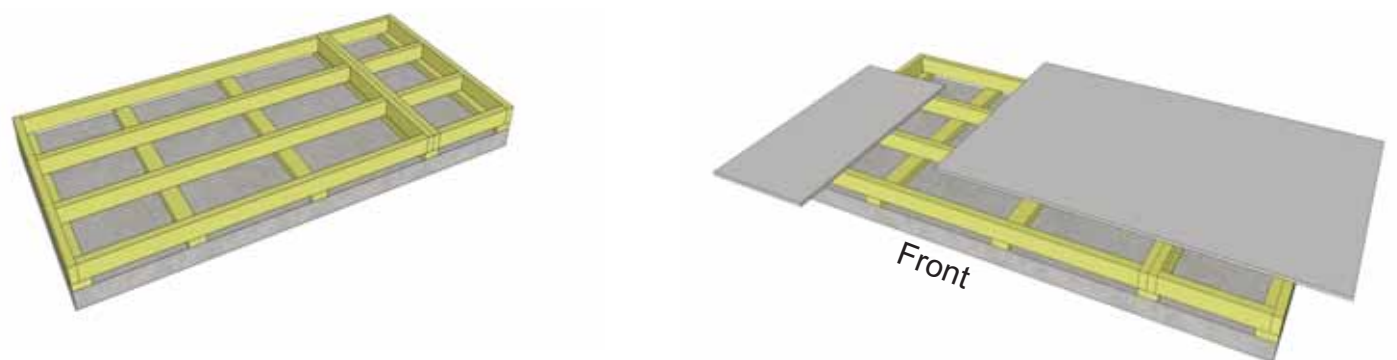

**6.** When in place, level floor completely before proceeding.

**7.** Position **Plywood Floor** pieces (2) on top of completed floor joists.

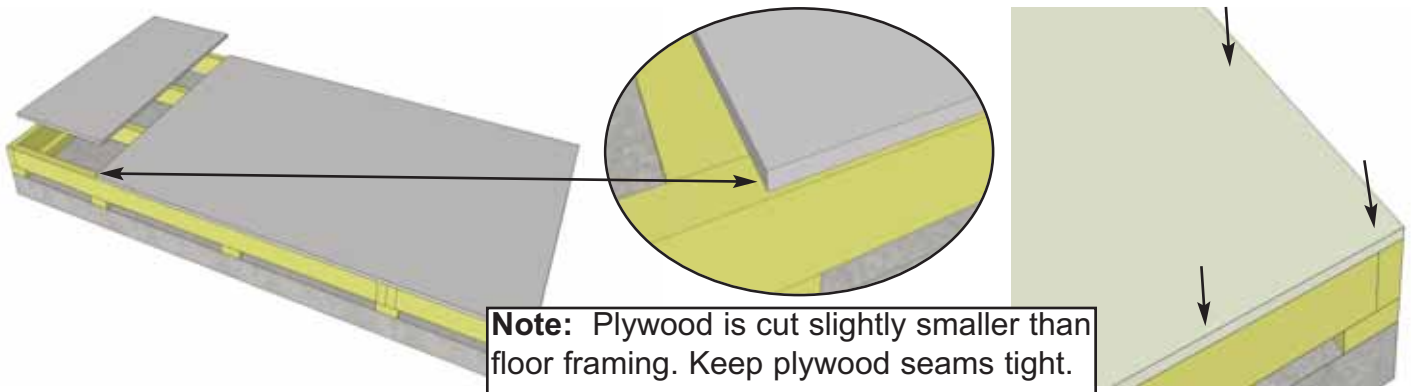

**8.** Position Plywood so it sits almost flush with outside of floor joist framing (see **Note**). When correctly positioned, attach to all floor joists with 1 1/4" screws. Use screws every 16".

## B. Wall Section

**Exploded view of all parts necessary to complete the Wall Section. Identify all parts prior to starting.**

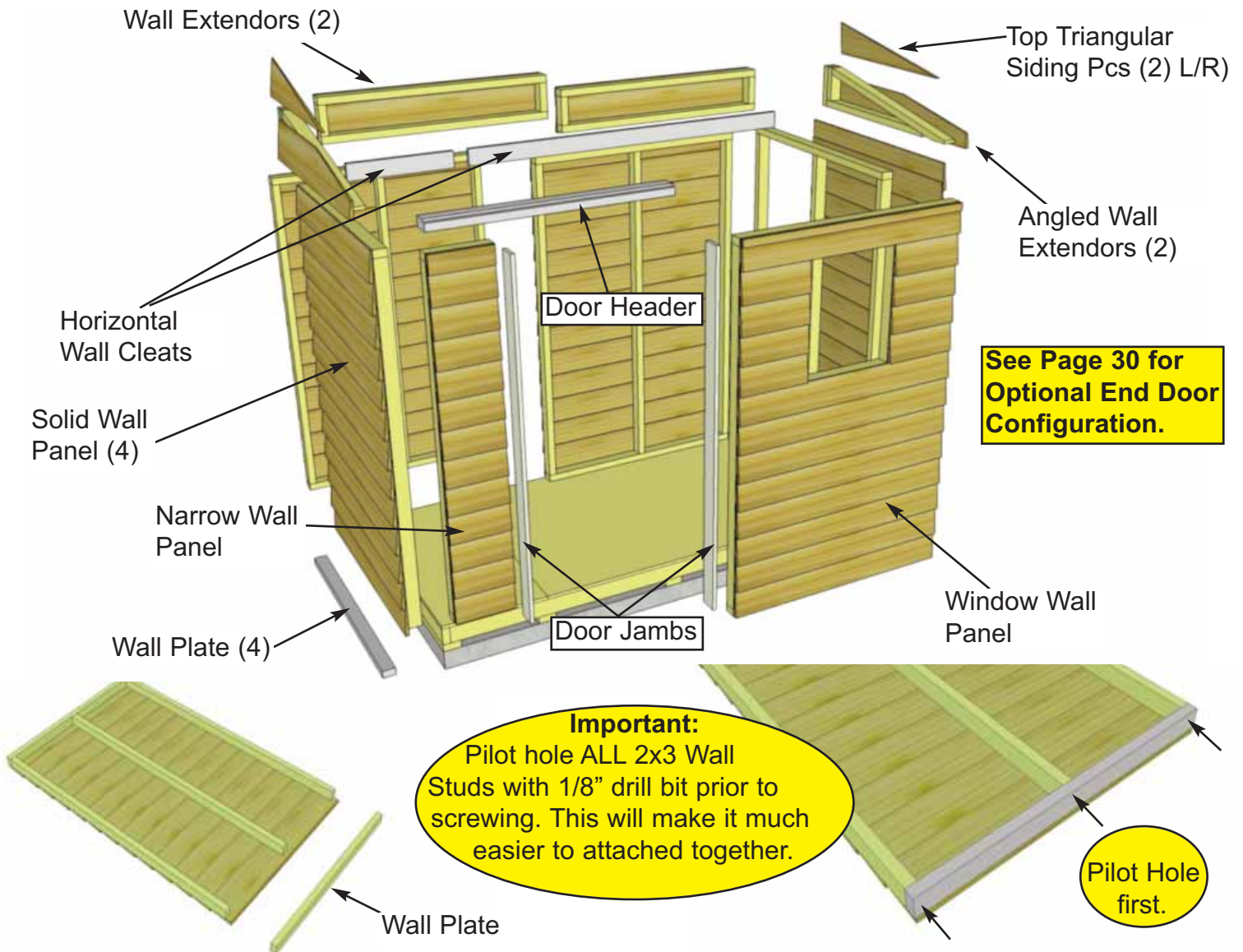

**9.** Locate 4 **Solid Wall Panels** and 4 **Wall Plates** (1 1/2" x 2 1/2" x 45 1/2"). Attach Plates to bottom of studs of each wall panel with 3 - 2 1/2" screws. Position so plates are flush with framing.

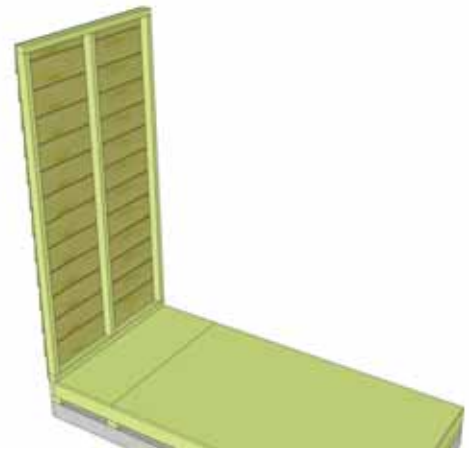
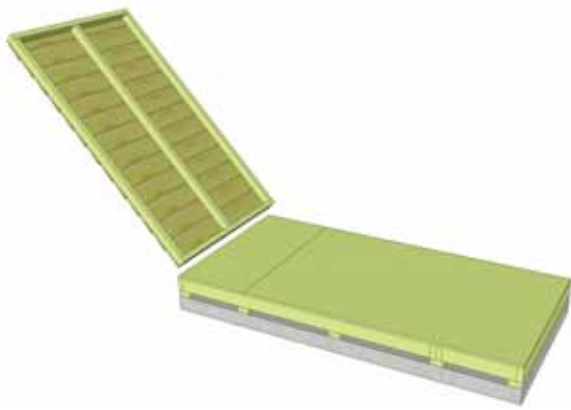

**10.** Starting on side, position a **Solid Wall Panel** on top of plywood floor. The Wall Panel bottom framing will sit flush with floor framing. Wall siding will overhang the floor. **Important:** Make sure all walls are aligned in their upright position. If not, water may leak into your shed. Unsure if panel is facing up or down? Recently attached Bottom Plate is on bottom of panel.

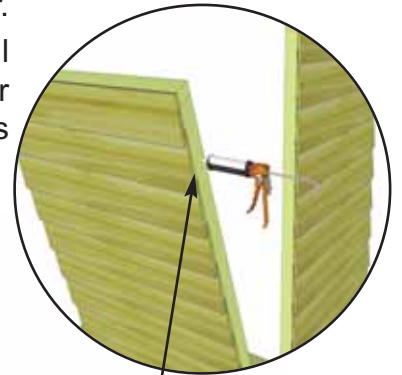

Do not align wall siding to floor. Align wall plate to outside of plywood floor.

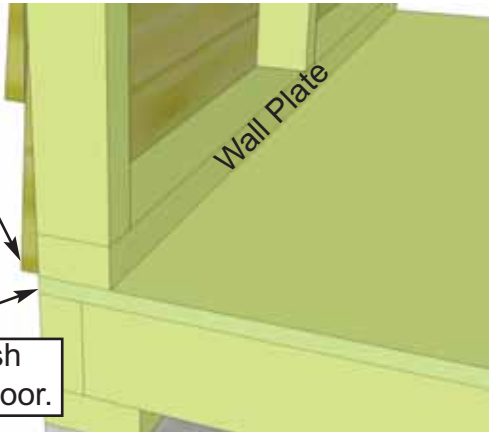

Wall Plate Flush with plywood floor.



**Optional-** Caulking seams will help prevent moisture from entering your shed. Caulking not included in kit.

**11.** Outside 2x3 framing of wall panel should be flush with outside of floor framing when properly aligned. **Note:** Do not align wall siding to floor. Align wall plate to outside of plywood floor. When positioned correctly, locate 2nd Solid Wall Panel and place in corner.

**Do Not Attach Walls To Floor until Step 30.**

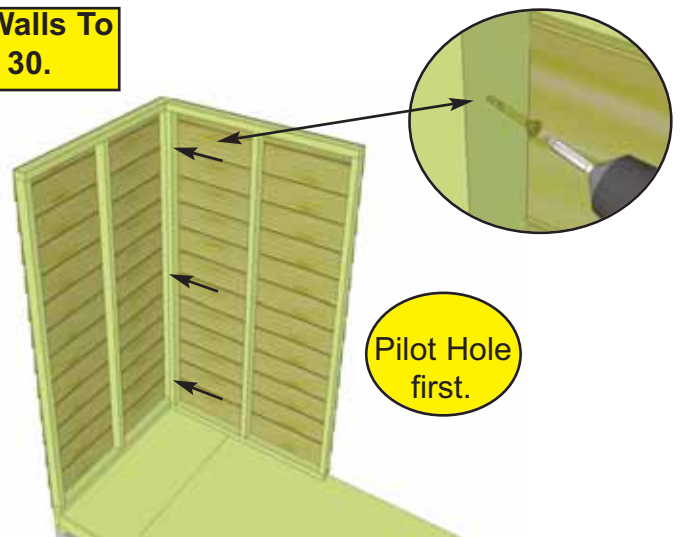

Pilot Hole first.

**12.** Butt both vertical wall studs of side and rear walls together and attach with 3 - 2 1/2" screws. Screw at the bottom, middle and top of stud to secure properly. Have helper push wall framing together while securing to ensure tight fit. **Note: Drill pilot holes in studs to prevent splitting.**



Pilot Hole first.

**13.** With the corner wall attachment complete, position the second rear wall panel in place so bottom 2x3 wall framing is sitting flush with outside floor framing. Wall siding should overhang floor by approximately 3/4". When positioned correctly, attach both wall panel studs together as per **Step 12** with 3 - 2 1/2" screws.

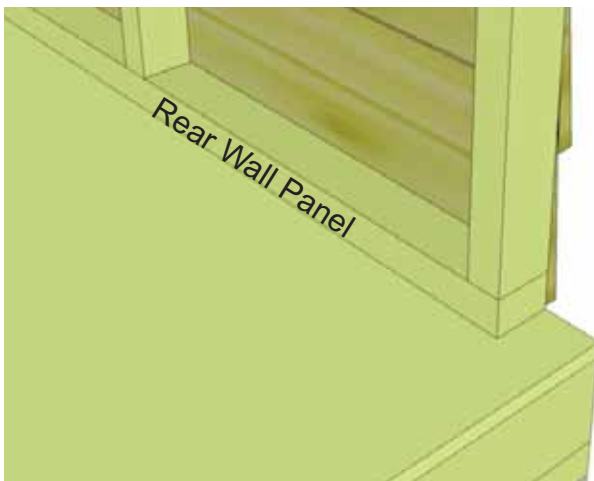

**Do Not Attach Walls To Floor until Step 30.**



**14.** With Rear Wall Panel in place, position other side wall panel on floor as per **Step 10 & 11**.

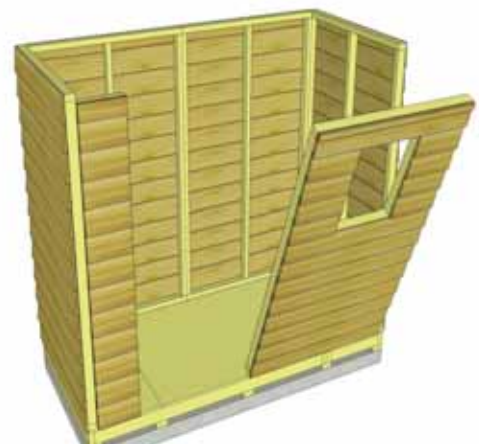
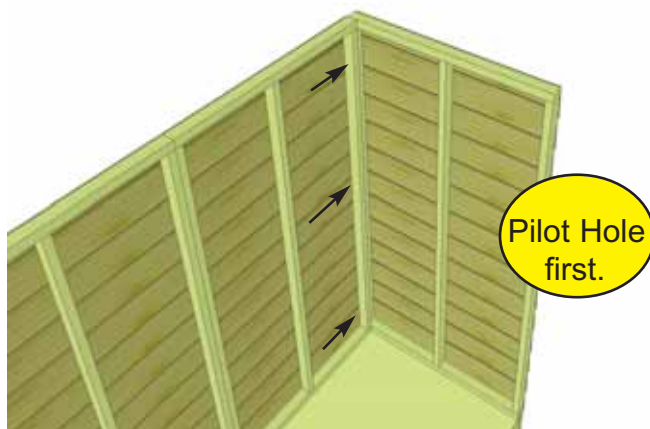

**15.** Secure side wall panel to rear wall panel as per **Step 12**. Next, locate a **Narrow Wall Panel** and position in front corner.



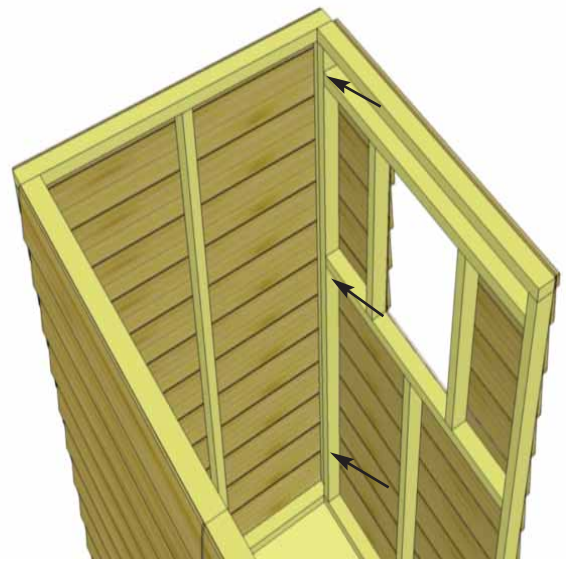
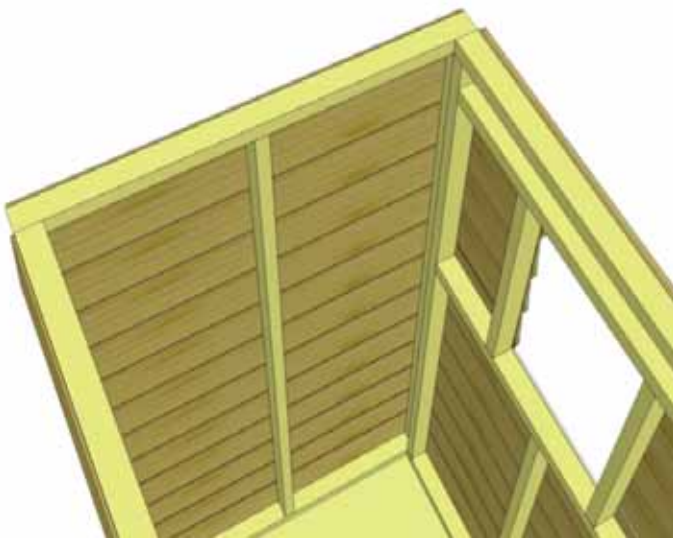

**16.** Align front corner Window Wall Panel as per **Steps 11 & 12.** using 3 - 2 1/2" screws to secure wall studs together.

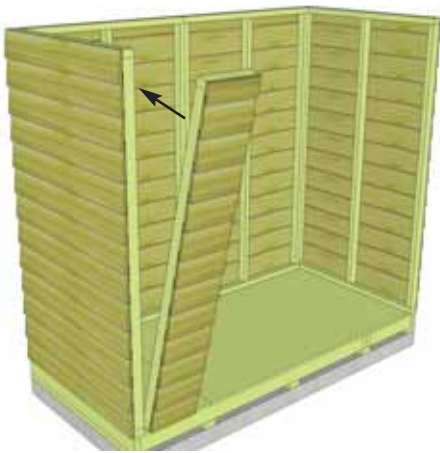

2x3 wall plate flush with plywood floor.

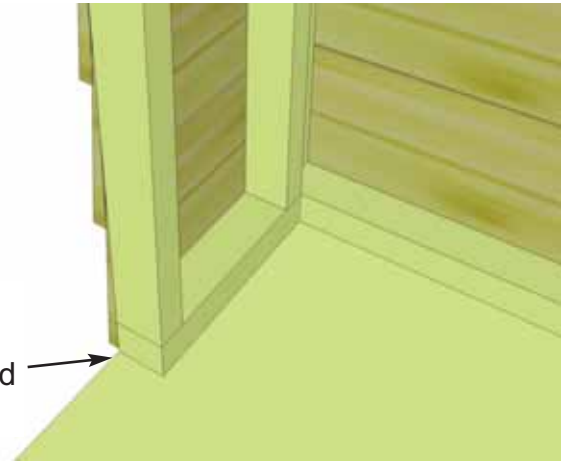

**17.** Once again position the 2x3 wall plate so it sits flush on floor and siding overhangs. **Note:** Narrow Wall Panel is only 73" high.

Pilot Hole first.

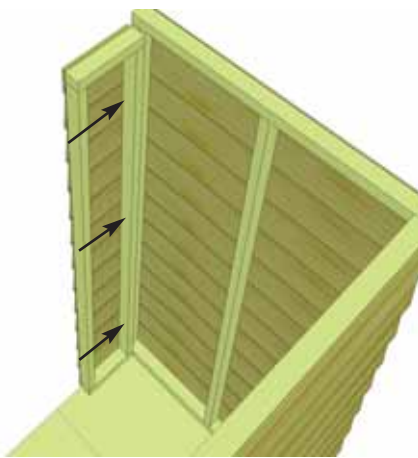

**18.** When correctly positioned, secure Narrow Wall Stud to Side Wall Stud with 3 - 2 1/2" screws.

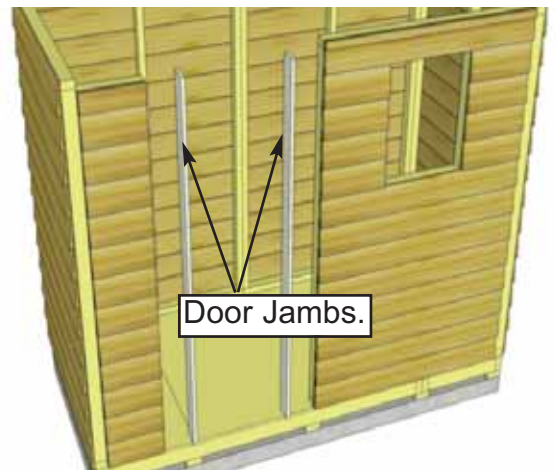

Door Jambs.

**19.** Locate **Door Jambs** (2@ 3/4" x 3 1/2" x 73") and place on wall stud to the right of door opening.

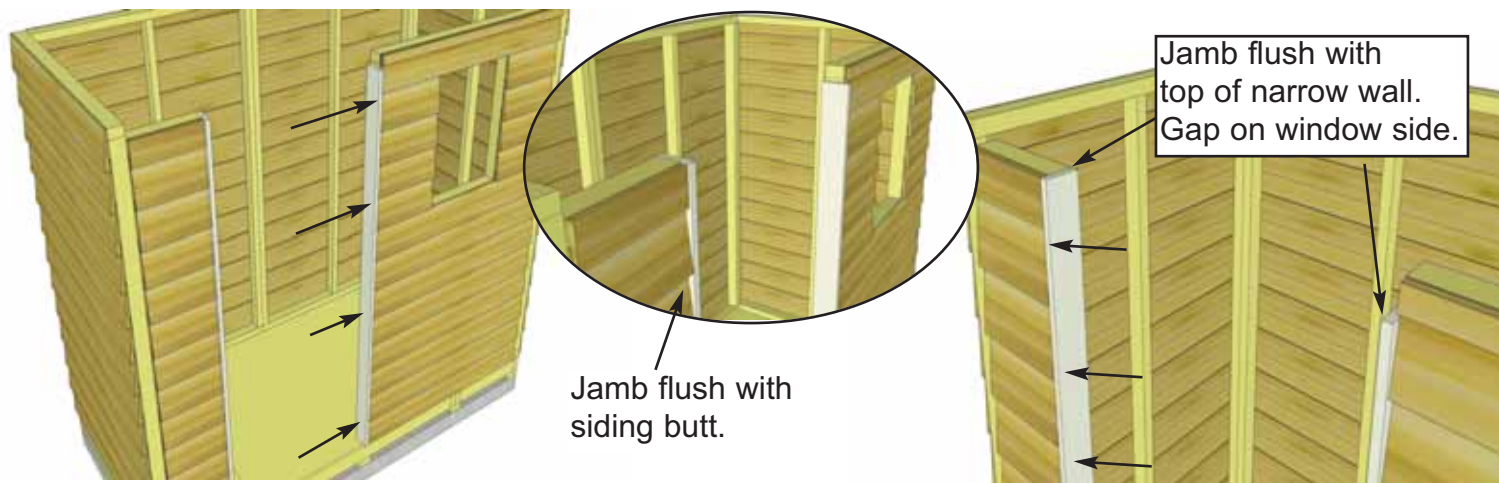

**20.** Position Door Jambs flush against narrow and window wall studs and tight to floor. The Jamb is 3 1/2" wide and will sit flush to outside of wall siding. When positioned correctly, secure Jambs using 4 - 2 1/2" screws.

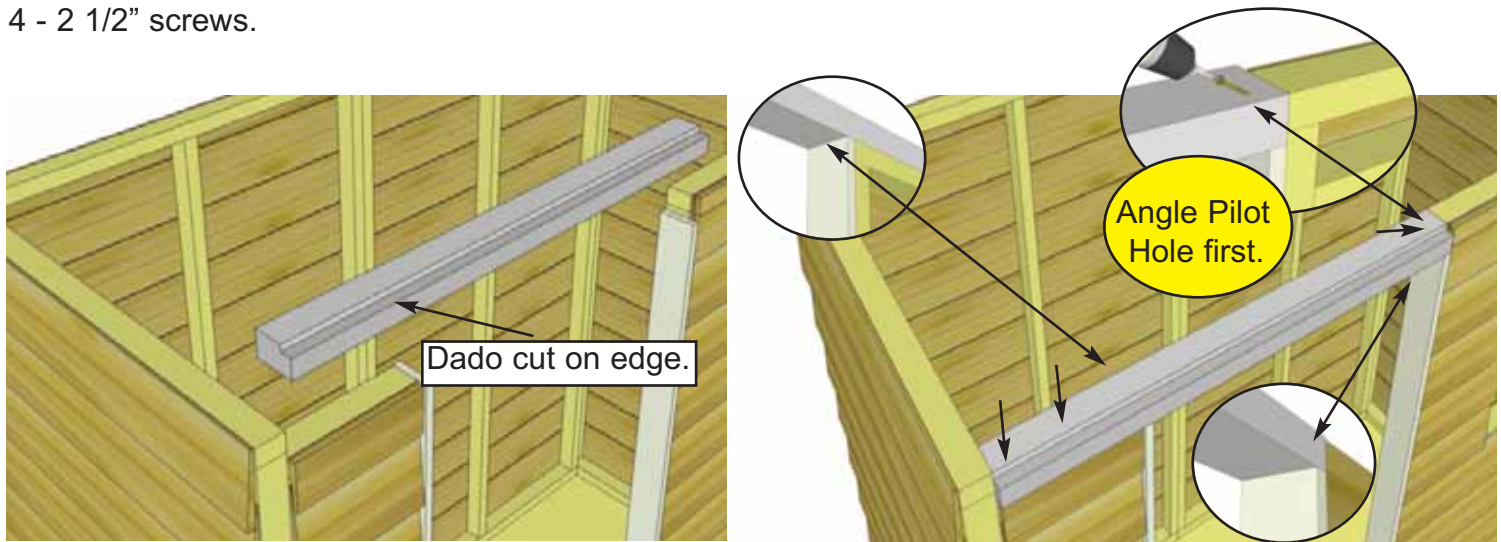

**21.** Position and attach the **Door Header** to top of Narrow Wall framing and against window wall framing resting on top of door jambs. Header should sit flush on Door Jambs. Attach with 4 - 2 1/2" screws. On window side, screw about 1" from end of header at angle into window wall framing. Pilot hole first.

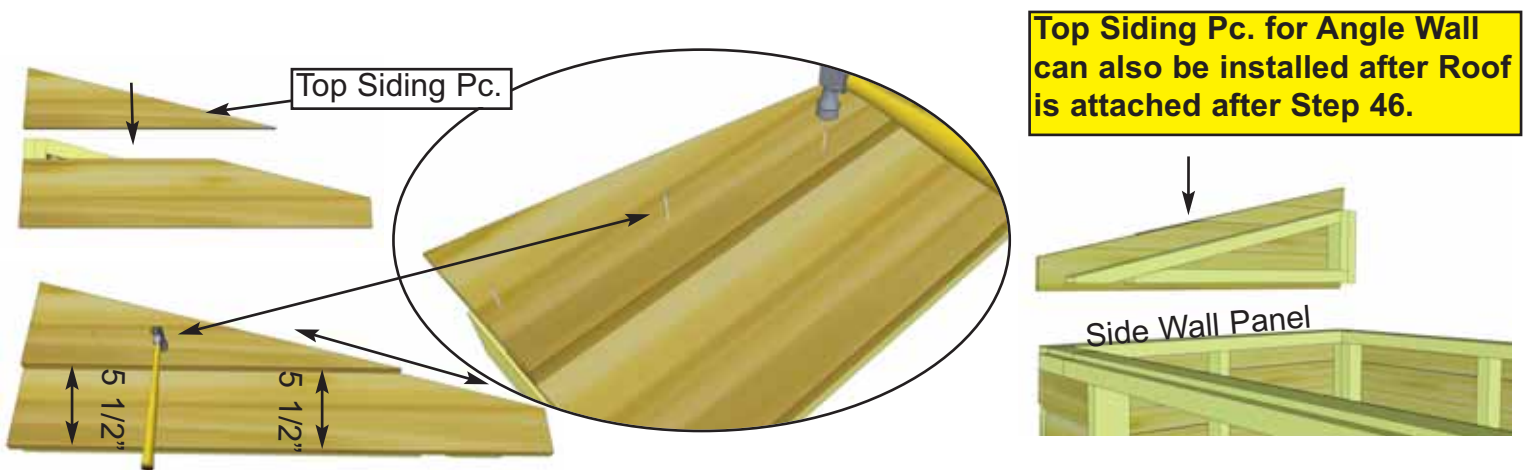

**22.** Locate an **Angled Wall Extendor** and **Top Siding Piece for Angled Wall Extendor (L/R)**. Position top siding on wall extendor and align as shown above. Attach with 3 - 1 1/2" finishing nails to top wall framing. There are left/right top siding pieces. Use rough surface side out.. Place finished wall extendor on side wall panel frame. Complete both sides now. **Note:** Bottom siding of wall extendor will overhang and cover siding of side wall.

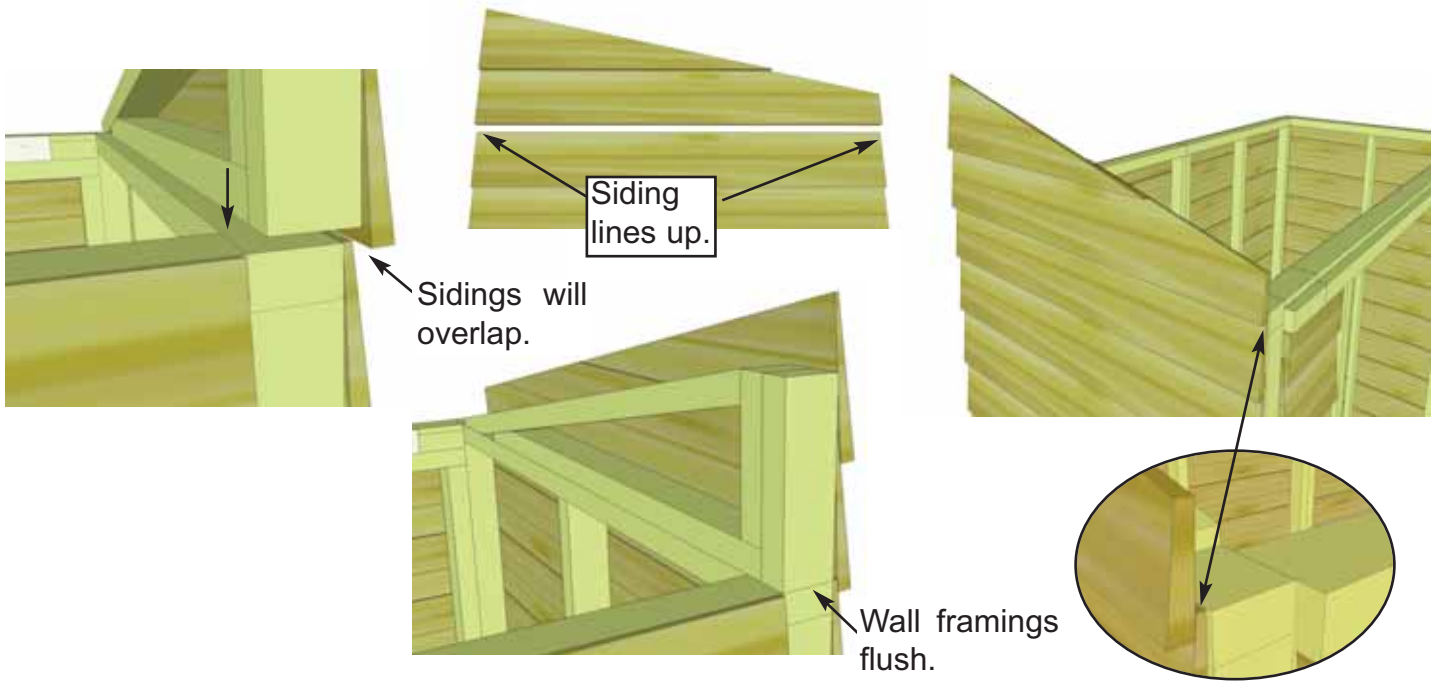

**23.** Align wall framing of Angled Wall Extendor and Side Wall so they are flush at the back. The siding for both walls should also align evenly from front to back.

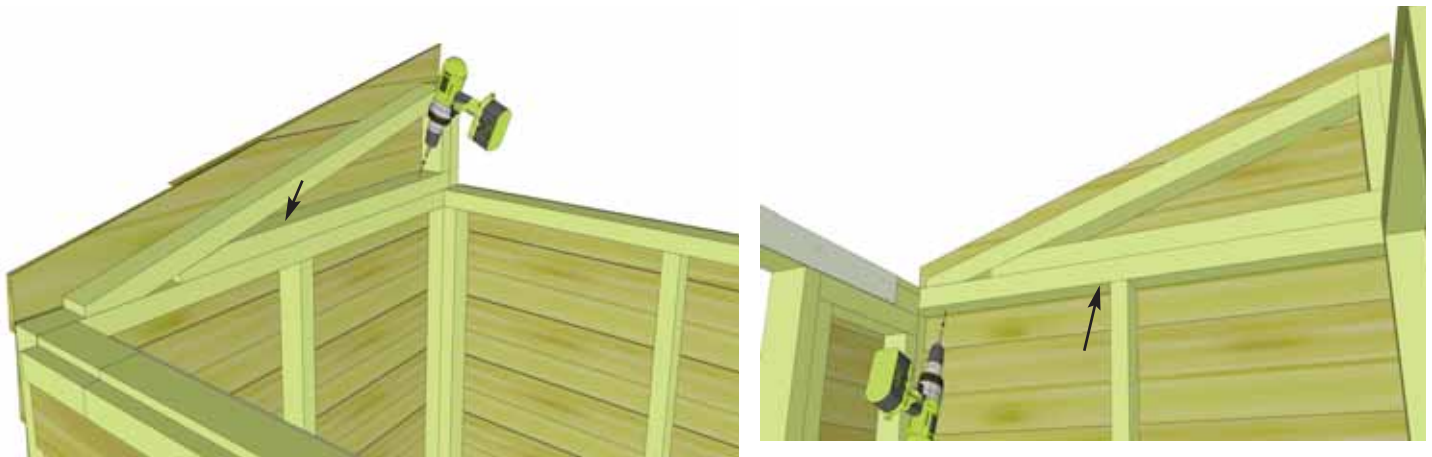

**24.** With Angled Wall Extendor and Side Wall aligned correctly, secure together from the inside with 4 - 2 1/2" screws.



**25.** Complete opposite Angled Wall Extendor positioning and attachment as per **Steps 23 & 24.**

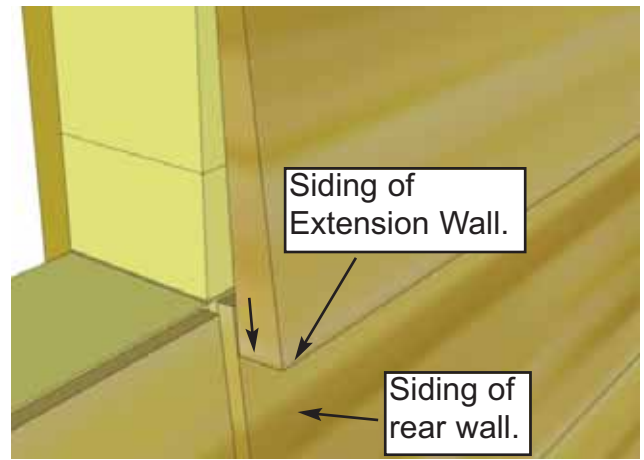
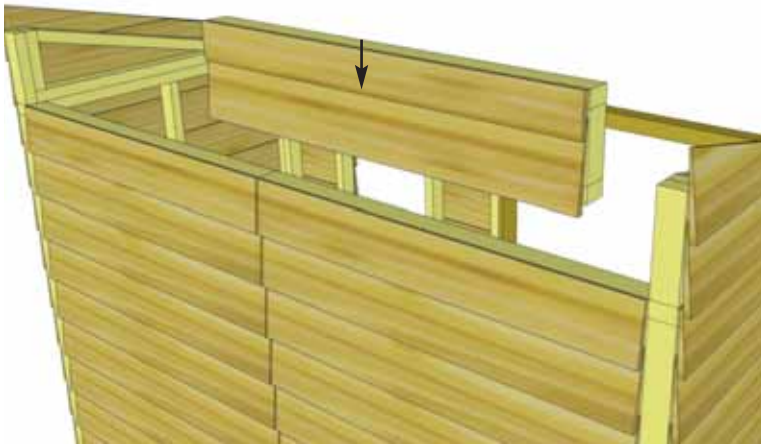

**26.** Locate one **Wall Extendor** and place on rear wall panel with siding of extendor overlapping that of the rear wall.

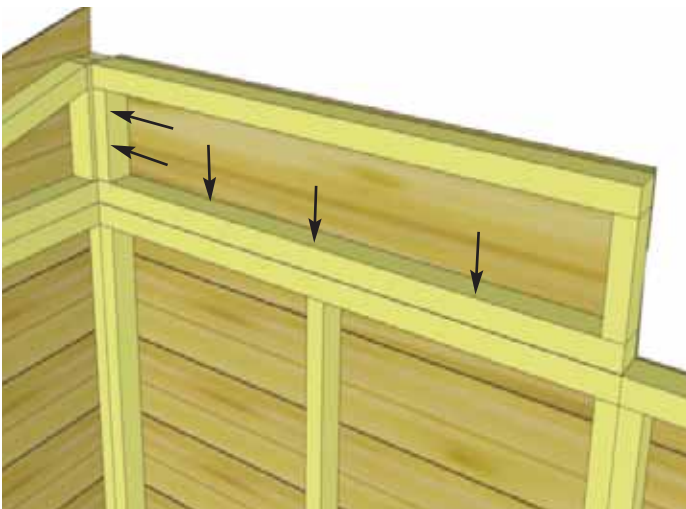

**27.** With 2x3 wall framing aligned, attach Wall Extendor to both the Angled Wall Extendor framing and the rear wall framing with 5 - 2 1/2" screws.

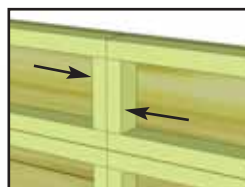
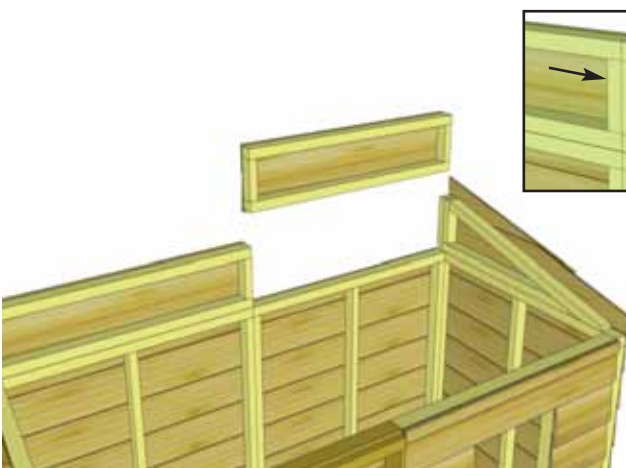

**28.** Position and secure 2nd Wall Extendor Panel as per **Steps 26 & 27**. Additionally, attach to first Extendor with 2 - 2 1/2" screws.

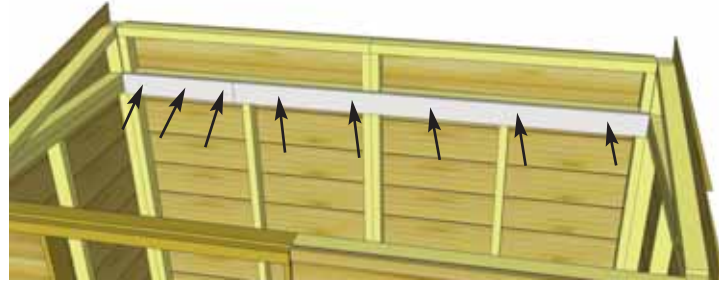
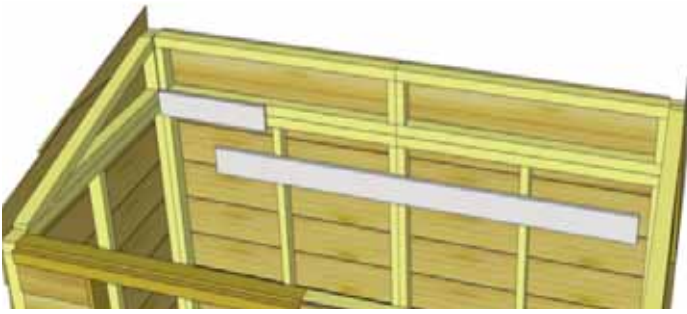

**29.** Attach **Horizontal Wall Cleats** (1 @ 3/4" x 3 1/2" x 70", 1 @ 3/4" x 3 1/2" x 21") to Wall Extendor bottom framing and Rear Wall top framing, so that cleat is flush with extendor framing. There is a short and a long wall cleat. Alternate alignment of screws, so half screw into Wall Extendor Framing and half into Rear Wall Top Framing. Use 8 - 1 1/4" screws.

**30.** To complete Wall Section, attach bottom 2x3 wall plates to plywood floor with 20 - 2 1/2" screws. Confirm Doorway opening is 32" wide. Prior to securing, make sure wall panels are aligned correctly on the floor. Refer to **Step 11**. Wall siding should overhang floor while 2x3 wall plates should sit flush with floor.

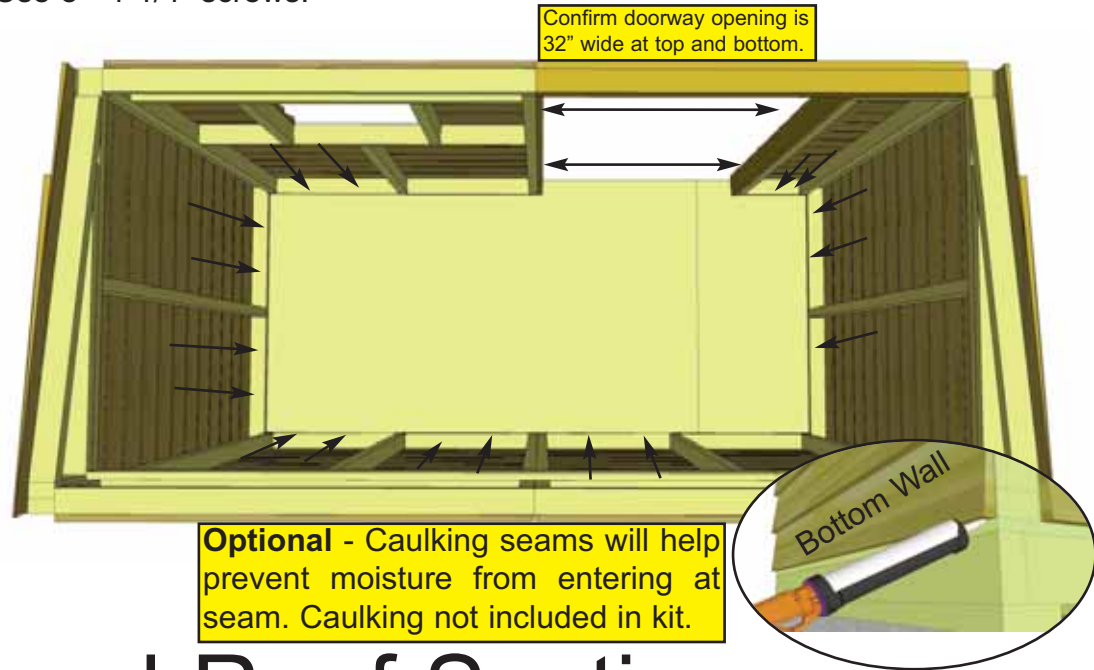

## C. Rafter and Roof Section

**Exploded view of all parts necessary to complete the Rafter and Roof Section. Identify all parts prior to starting.**

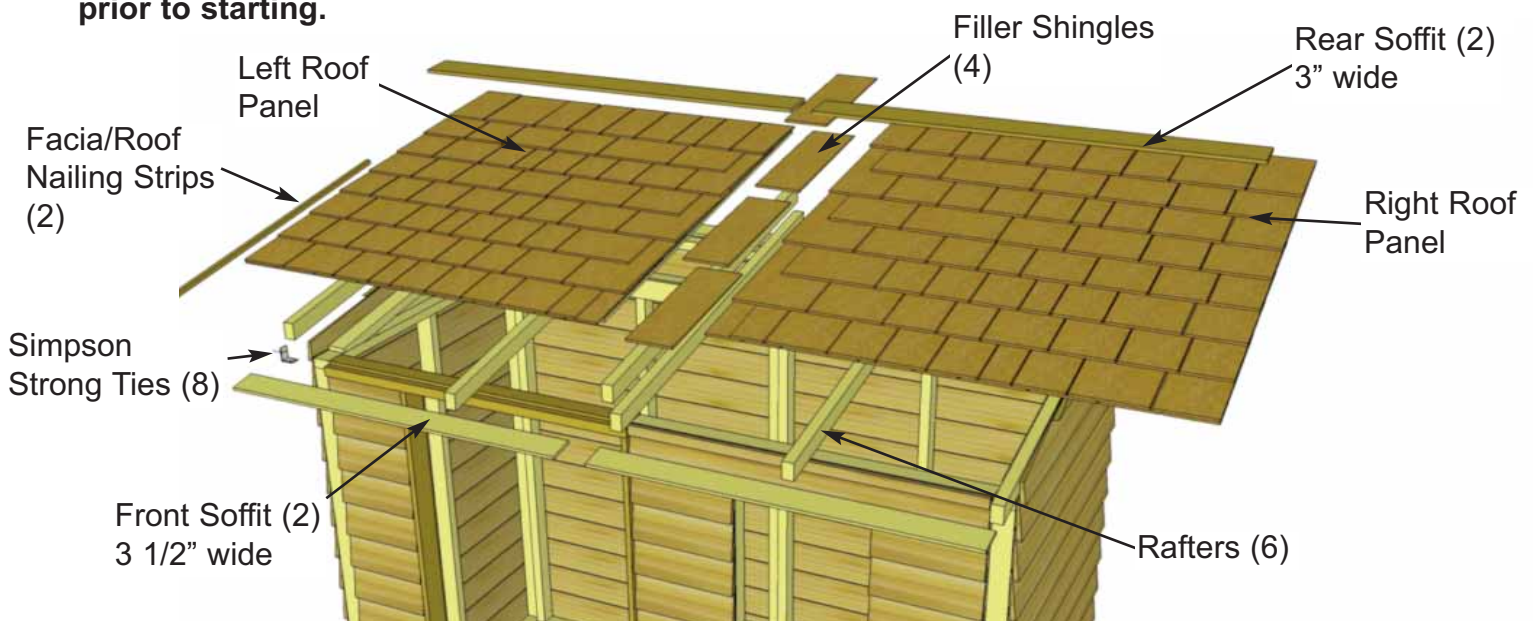

Note: We recommend you drill a 1/8" pilot hole for each screw, to avoid splitting wood. The hole depth should be equal to 3/4 the length of screw.

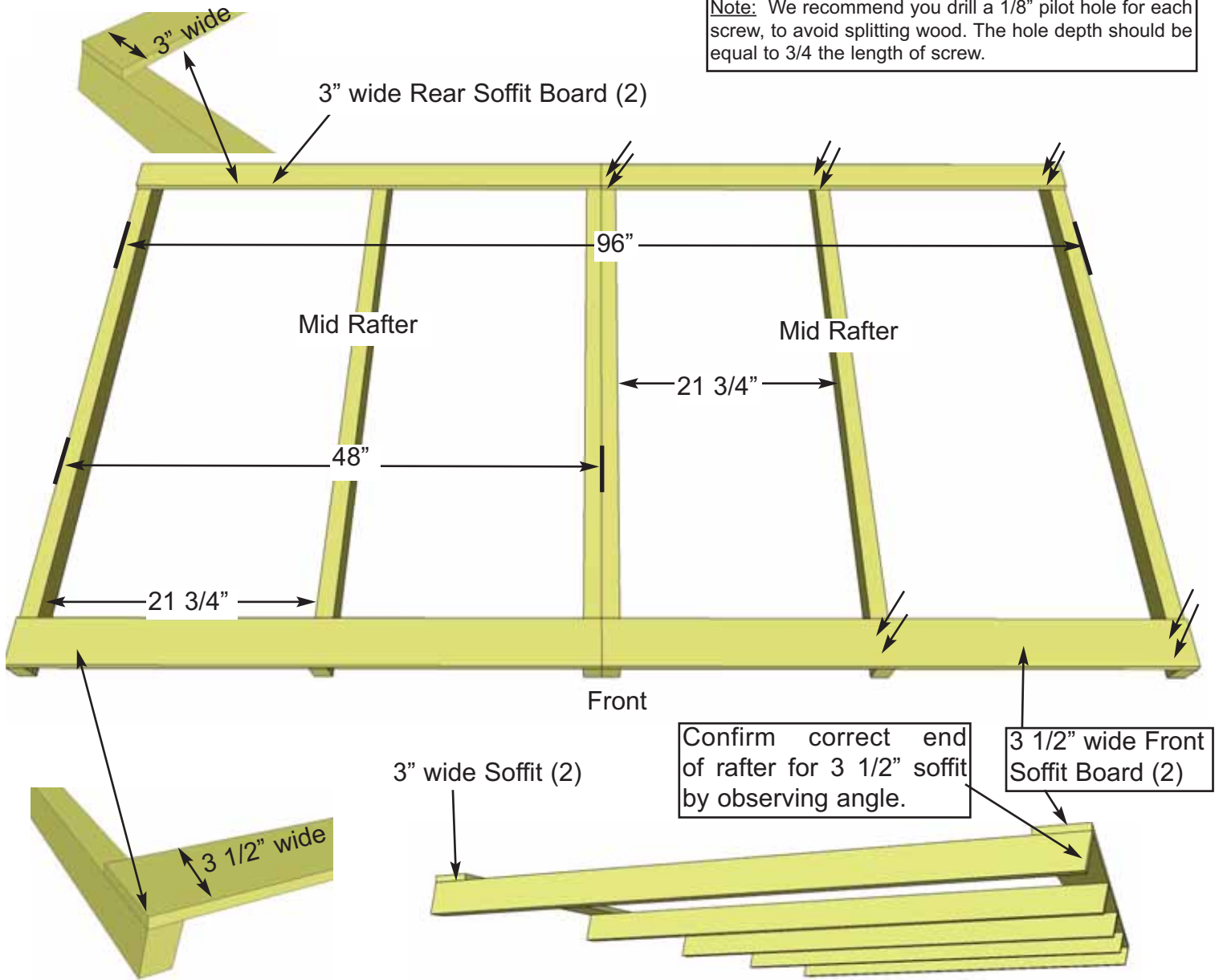

**31.** Locate 6 Rafters, 2 Front 3 1/2" wide Soffits and 2 Rear 3" wide Soffits. Lay out on level ground and assemble as shown in Illustrations A through C below. Attach Soffit Boards flush to end of outside rafters with 2 - 1 1/4" screws per rafter end. **Important:** Drill pilot holes in Soffit ends to prevent splitting. Measure and attach interior Rafters as illustrated above. Measure and attach remaining Soffit/Rafter connections using 2 - 1 1/4" screws per rafter/soffit.

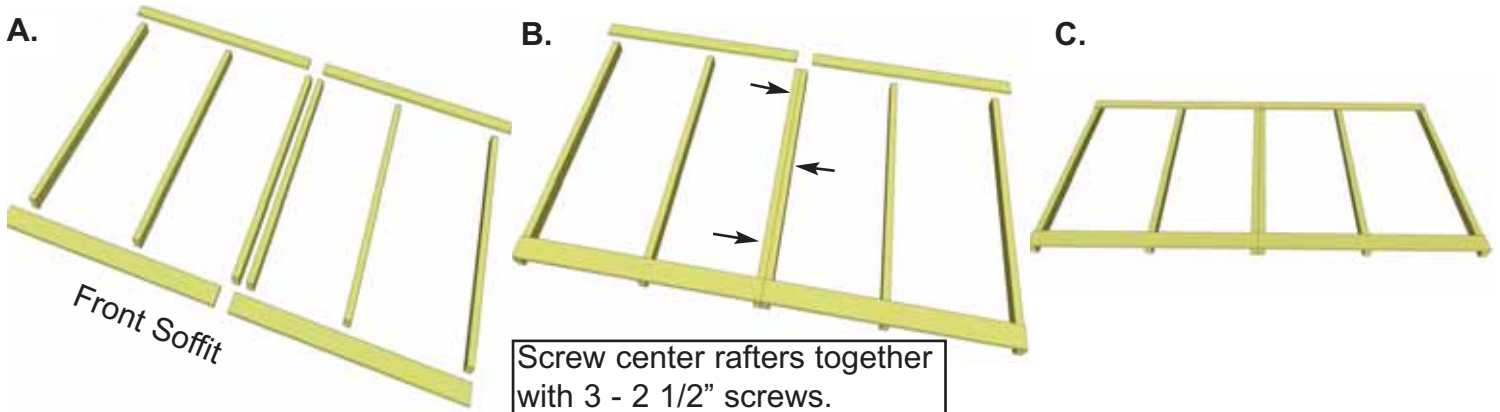

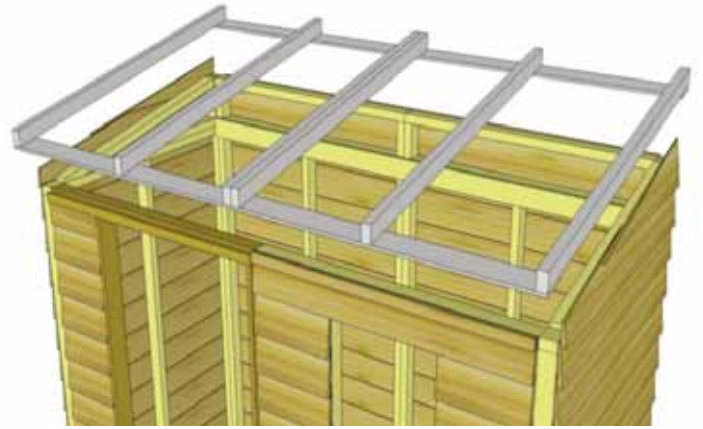

**32.** Carefully flip completed Rafter Section over so 3 1/2" wide Soffit is facing the front and place on SpaceSaver walls. **Note:** once again, make sure 3 1/2" wide Soffit is positioned to the front of the shed.

3 1/2" Wide Soffit to the front.

Rafter sits on framing.

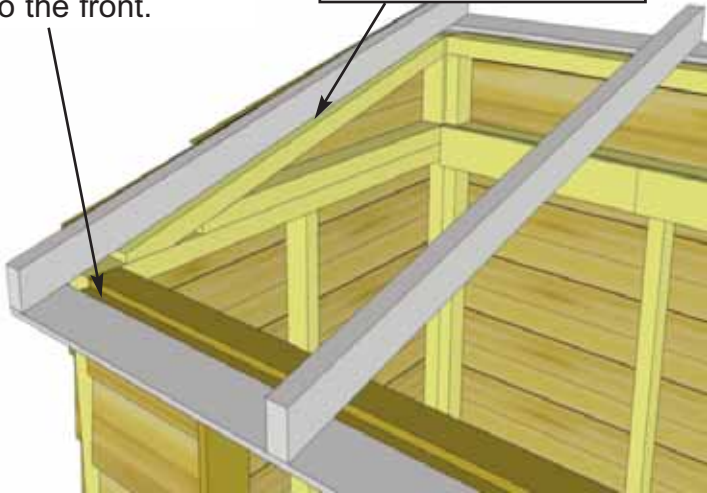

**33.** Position completed Rafter Section on top of walls. Outside Rafters will sit on Extension Wall framing and be positioned equally from side to side.

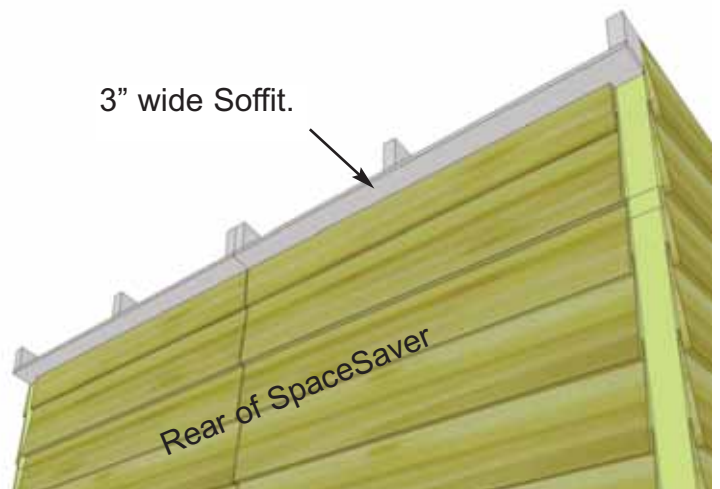

**34.** When Rafter Section is positioned correctly, Front Soffits will sit approximately 1/8" away from wall siding. The Rear Soffit may touch wall siding. This can vary slightly.

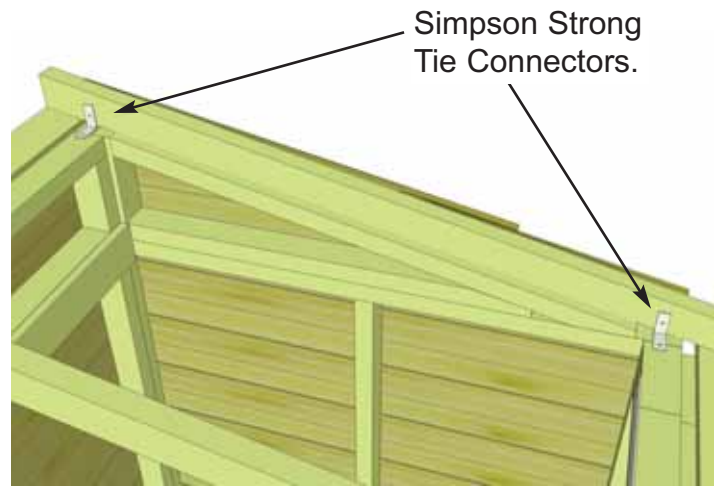
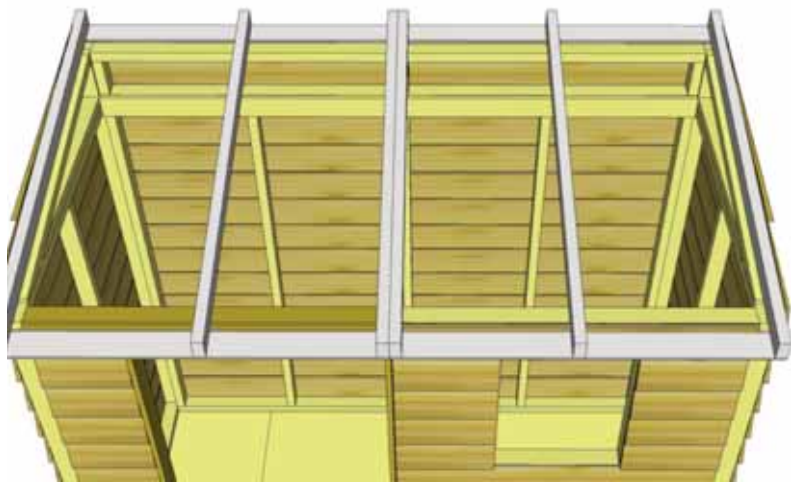

**35.** With Rafter Section correctly aligned, secure rafters to walls using **Simpson Strong Tie Connectors**. Start with outside rafters and secure 2 Strong Ties with 1 1/4" screws. Screw into Wall Extension Framing at the rear and Wall Panel top framing at the front. Complete both sides.

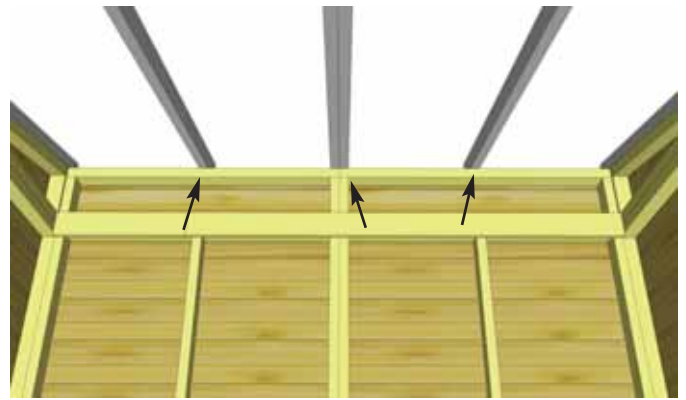
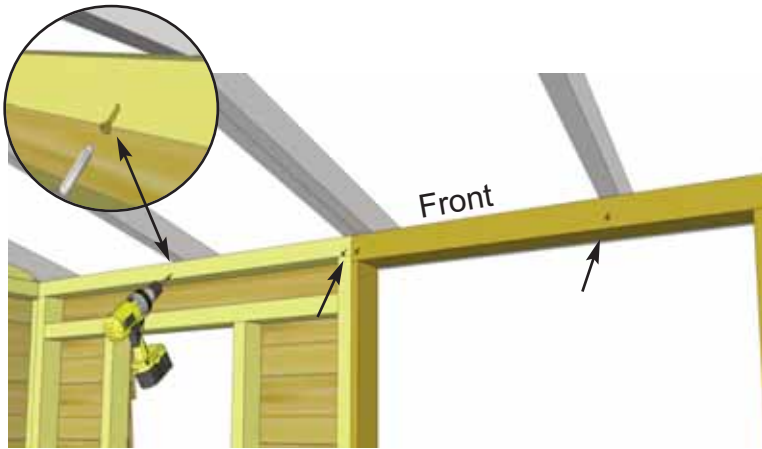

**36.** With outside rafters properly secured, completely secure remaining interior rafters using 6 - 2 1/2" Screws. Screw into rafters from inside of Header on an angle at front of shed, and from inside of Extension Wall Framing at rear of shed.

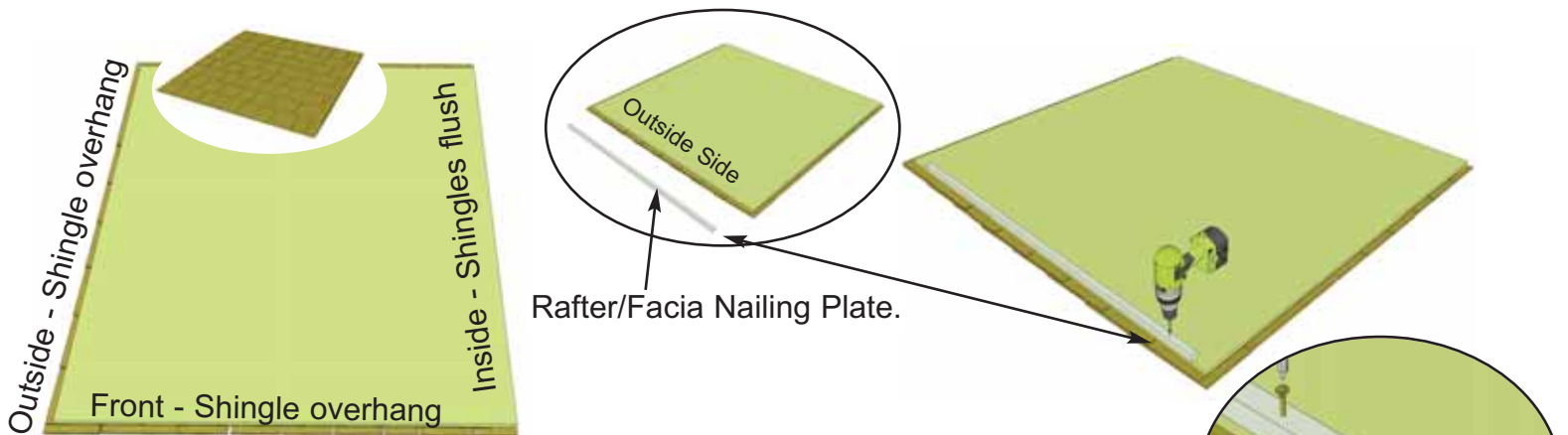

**37.** Carefully flip Roof Panels over so plywood sheathing is facing up. **Center Rafter/Facia Nailing Plates** (2) (3/4" x 3/4" x 48") onto outside of each panel flush with plywood. Attach with 4 - 1 1/4" screws evenly spaced. The Rafter/Facia Nailing Plate provides for a greater nailing surface later when you attach side facia.



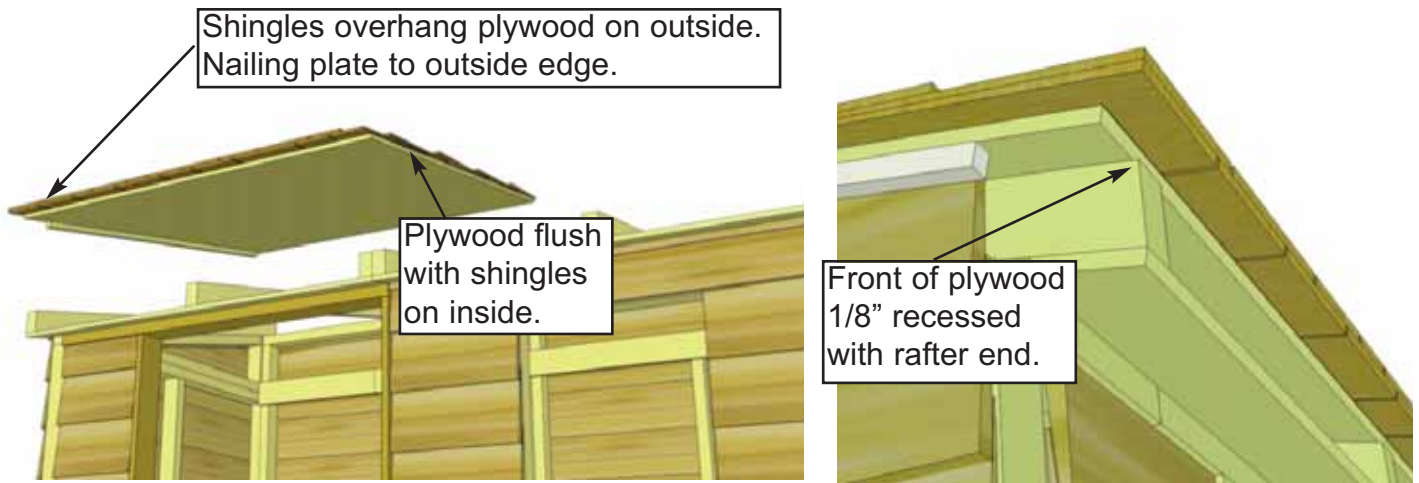

**38.** Correctly orientate Left Side Roof Panel, with shingles overhanging plywood on the side of the shed and flush with plywood to the middle. Place on rafters with front of plywood just about flush with rafter ends but just slightly recessed. Doing so allows front fascia to sit better.

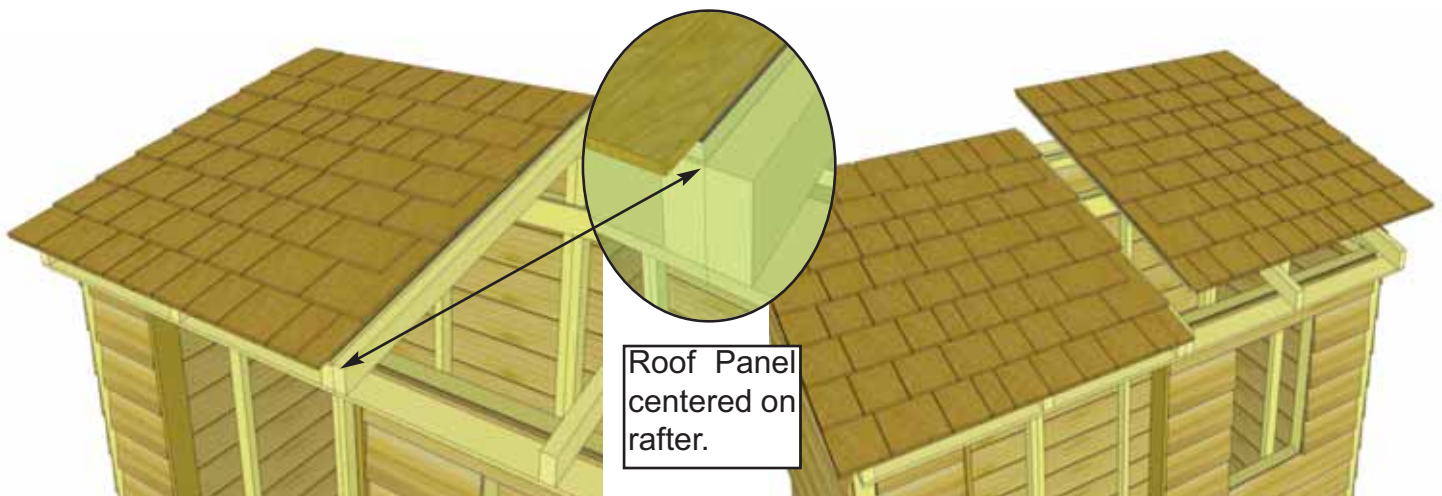

**39.** For correct Roof Panel position, align panel so plywood sits evenly on Center Rafters. Complete both roof Panels.

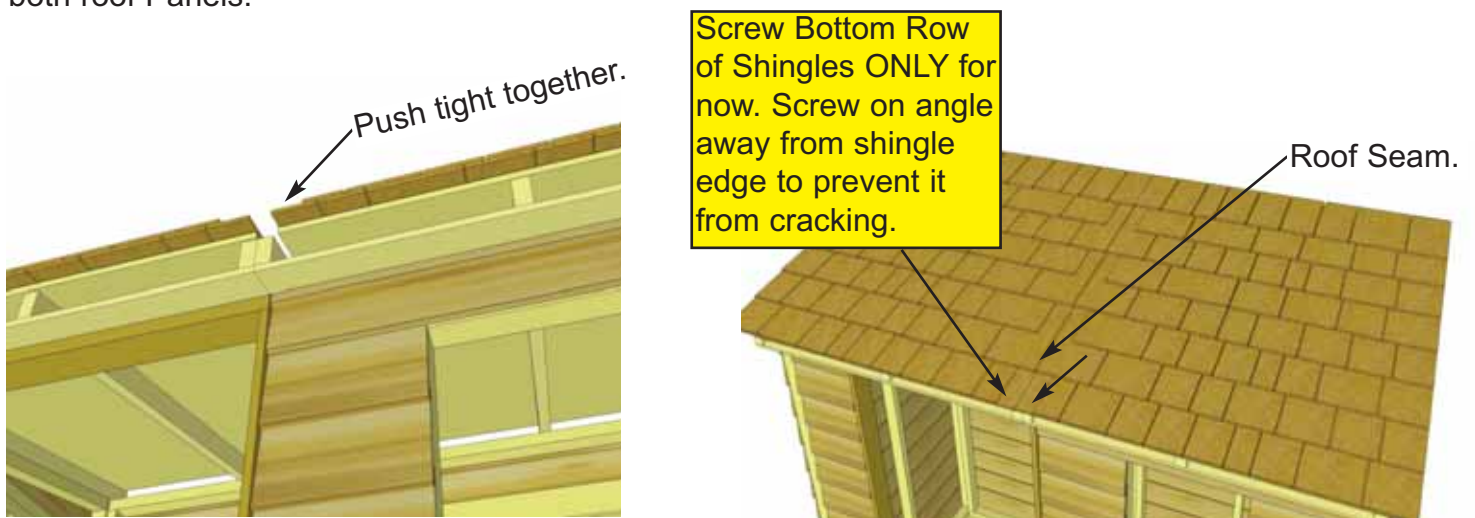

**40.** With Roof Panels aligned, screw panels down to center rafters with 2 - 2 1/2" screws in **Bottom Row of Shingles Only (1 screw per panel).**

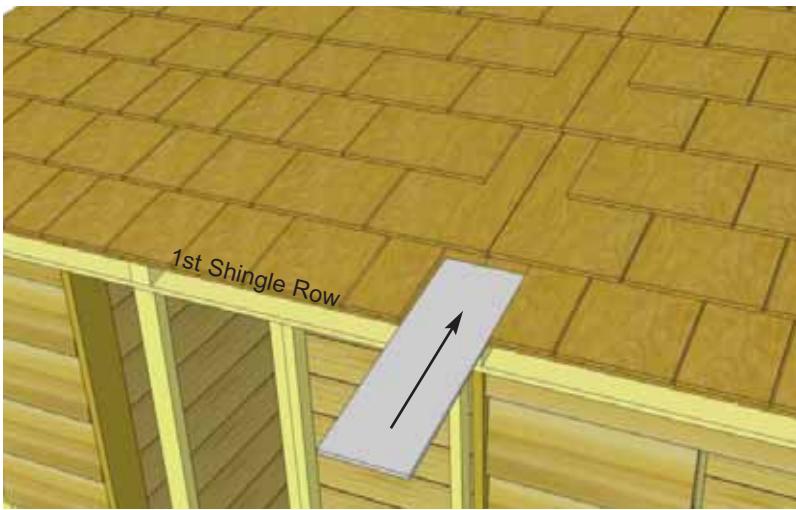

**41.** To cover roof seam, slide one **Filler Shingle** (5 1/2" wide) up and underneath second shingle row. Push or bang filler carefully with a hammer until evenly spaced and butt is even with other 1st row of shingles.

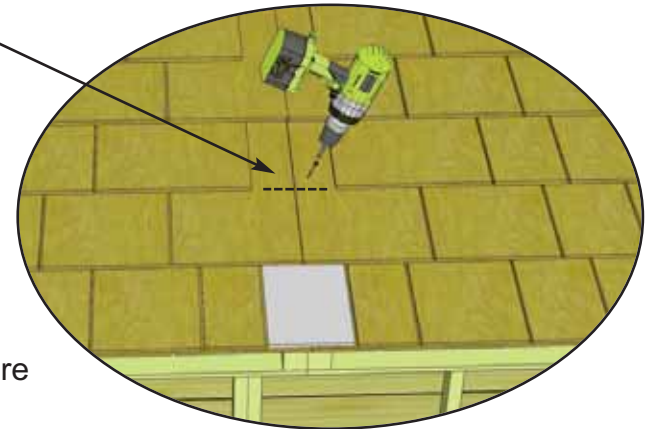
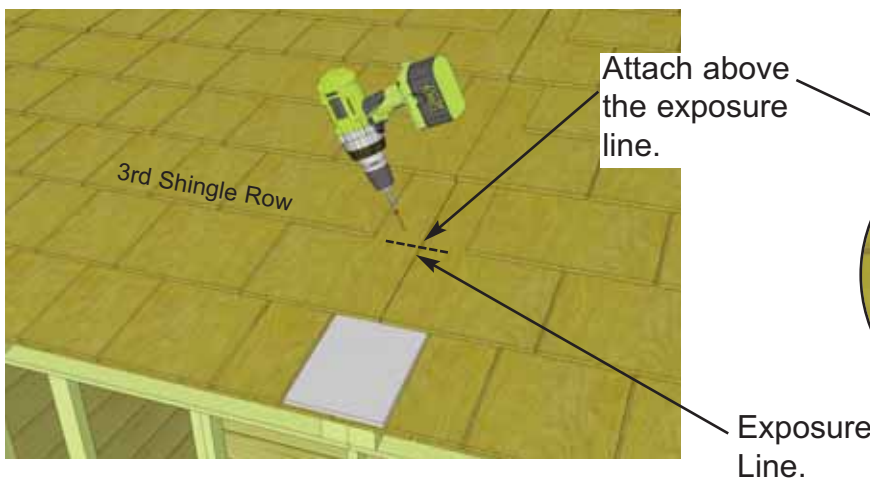
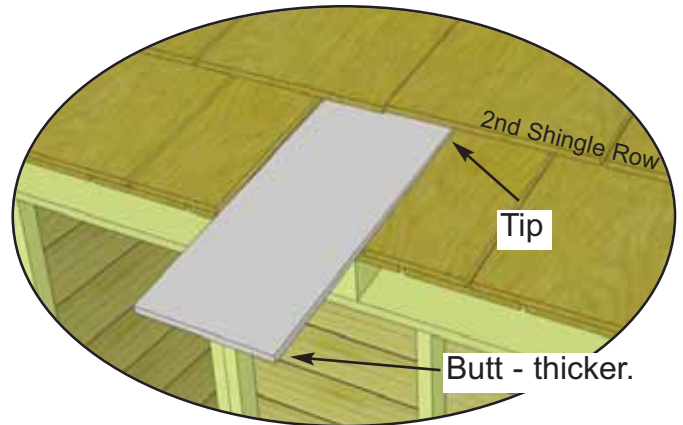

**42.** Screw first filler shingle down to rafters using 1 - 2 1/2" screw per panel (2 in total). Screw on slight angle and make sure to screw into rafter. Screw slightly above 3rd row of shingles (exposure line). This way, the screw will get covered up when you install your 2nd Filler Shingle and will prevent leaking.

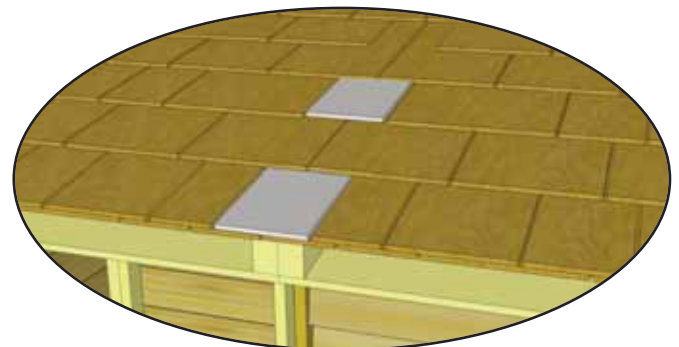
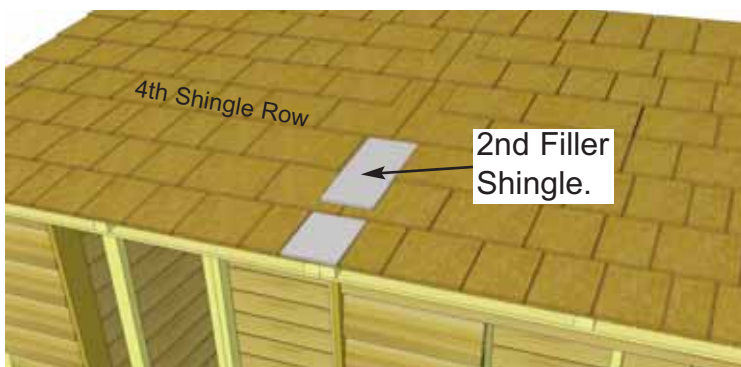

**43.** Slide 2nd **Filler Shingle** up and underneath fourth shingle row. Follow **Steps 41 - 42** to align and attach.

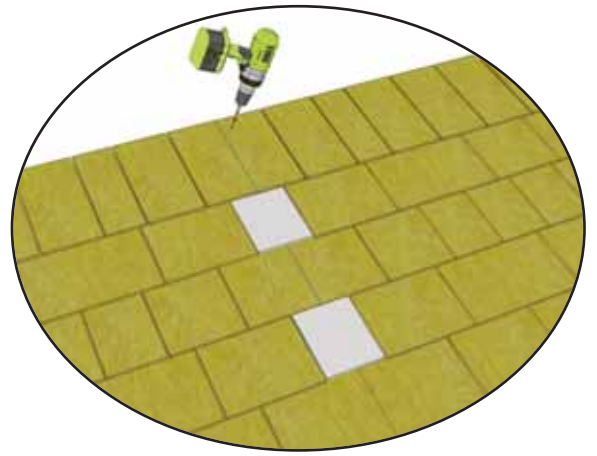
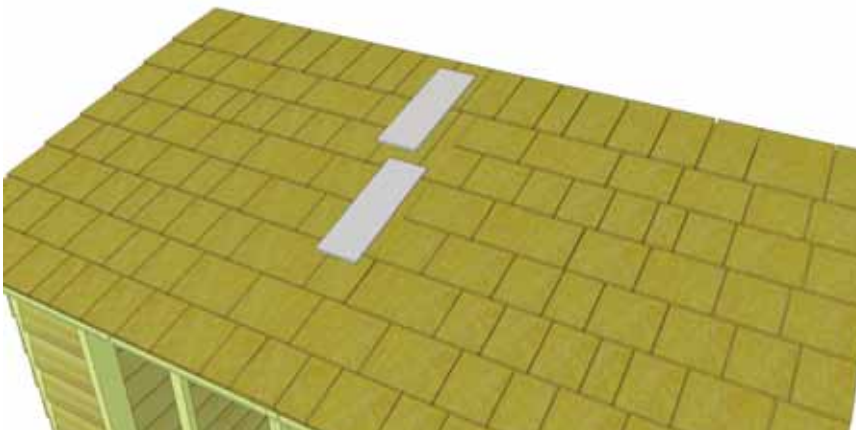

**44.** Slide 3rd and 4th **Filler Shingles** up and underneath appropriate shingle rows and follow **Steps 41 - 42** to align and attach. On last filler, screws will get covered by Roof Ridge Board (4 1/2" wide).

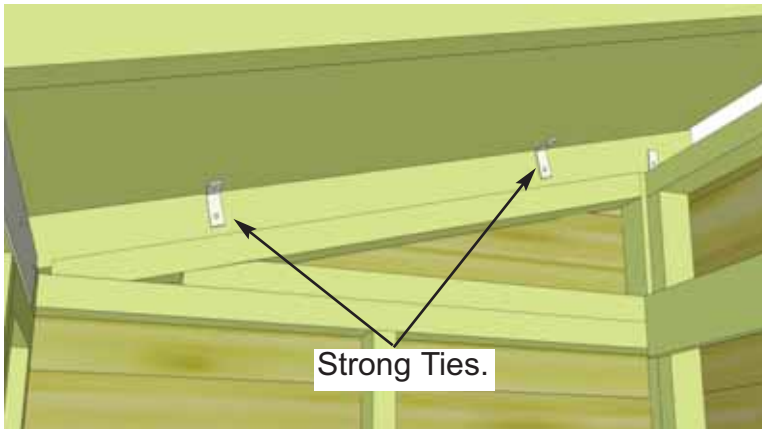

Strong Ties.

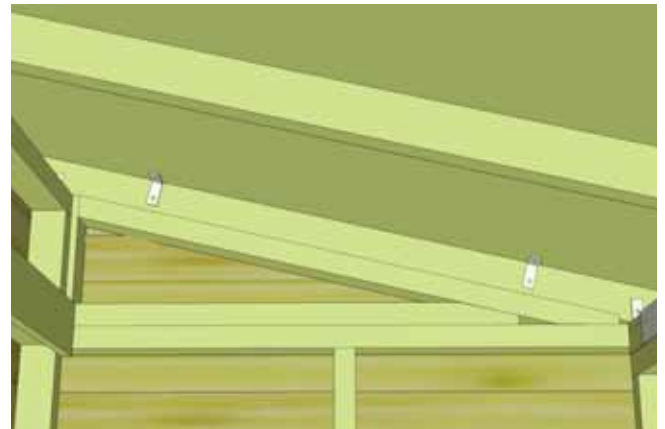

**45.** Secure roof panels to walls at both ends by positioning 2 Simpson Strong Ties on plywood and outside rafters and securing with 2 - 1 1/4" screws per Strong Tie. Complete both sides.

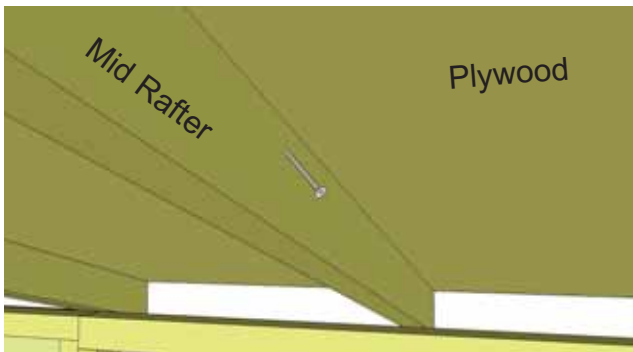

Mid Rafter

Plywood

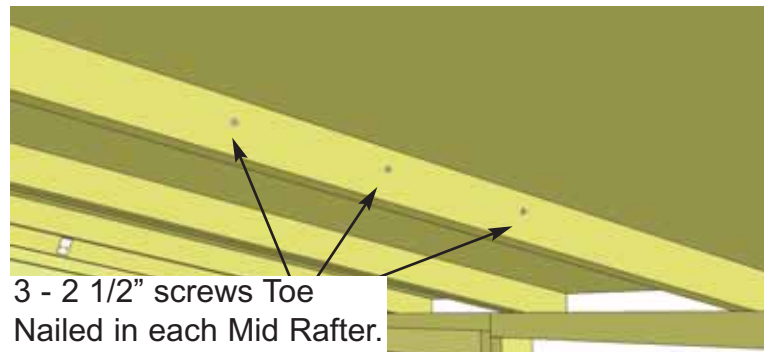

3 - 2 1/2" screws Toe Nailed in each Mid Rafter.

**46.** To further secure roof panels from the inside, drill pilot holes on an angle in each panel's Mid Rafter (3 per Rafter). Using 3 - 2 1/2" screws, secure rafters to plywood.

**Note:** from outside if possible, have a helper push roof panel down so plywood sits flush against rafter while securing.

**Note:** If Top Siding Pc. for Angle Wall was not installed in step 22 it can be done now. Attach with 3 - 1 1/2" Finishing Nails per piece.

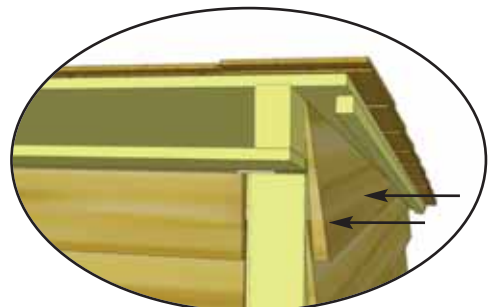
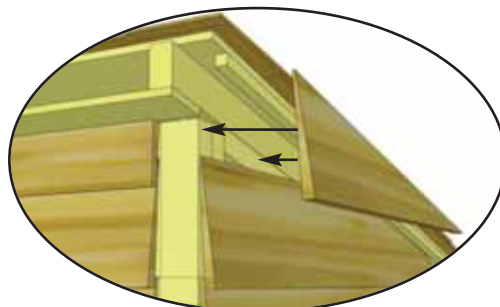

# D. Miscellaneous Section

Exploded view of all parts necessary to complete the Skirting, Trim, Facia and Miscellaneous Pieces. Identify all parts prior to starting.

(Not Shown: Door Stops, Flange, Threshold, Rear Trim, Horizontal Door Trim and Roofing Felt)

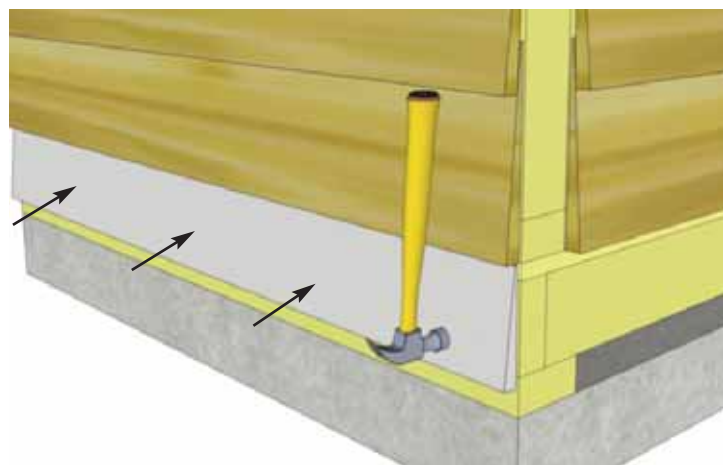
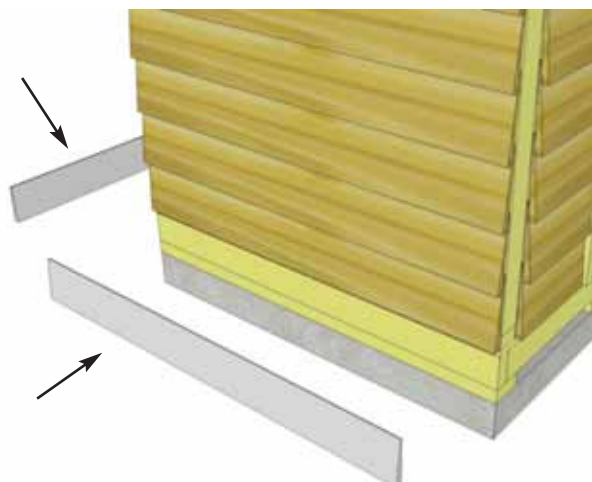
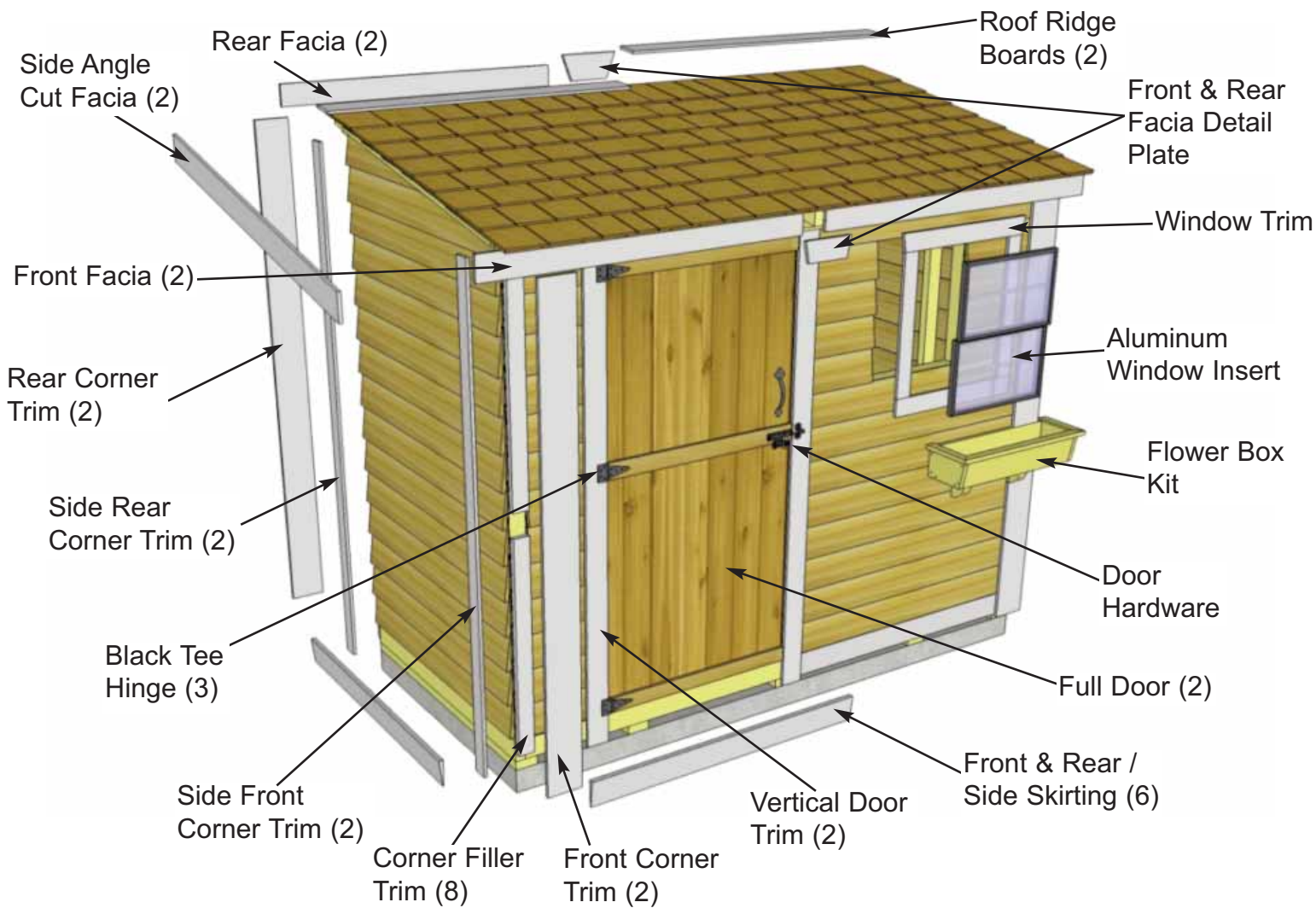

**47.** Attach **Bottom Skirting** (3/4" x 4 1/2" x 45 1/4" - bevel) around the base of the shed. Skirting will hide floor framing. Start with side skirting pieces first and attach with 4 - 1 1/2" finishing nails per piece.

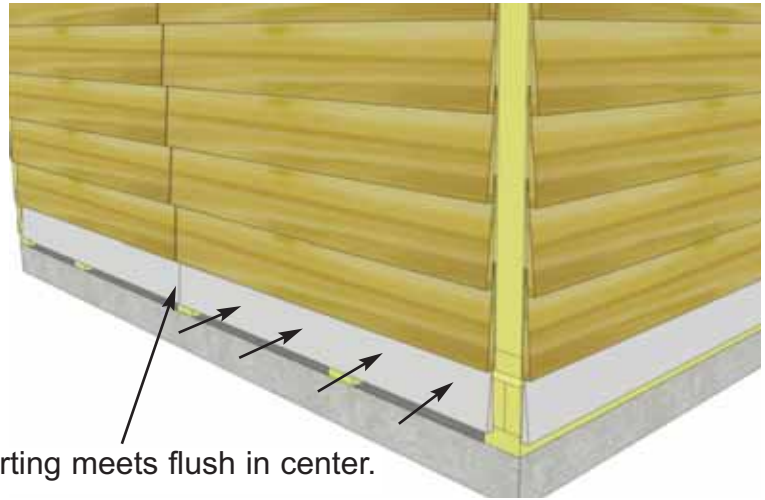

**48.** Rear skirting pieces will meet together in the center. Secure with 4 - 1 1/2" finishing nails per piece.

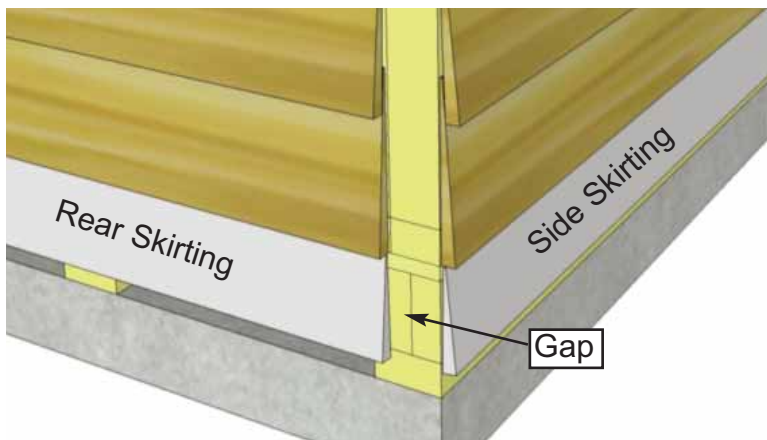

**49.** Gaps on outside will be covered by Corner Trim pieces later. Complete front and side skirting attachments.

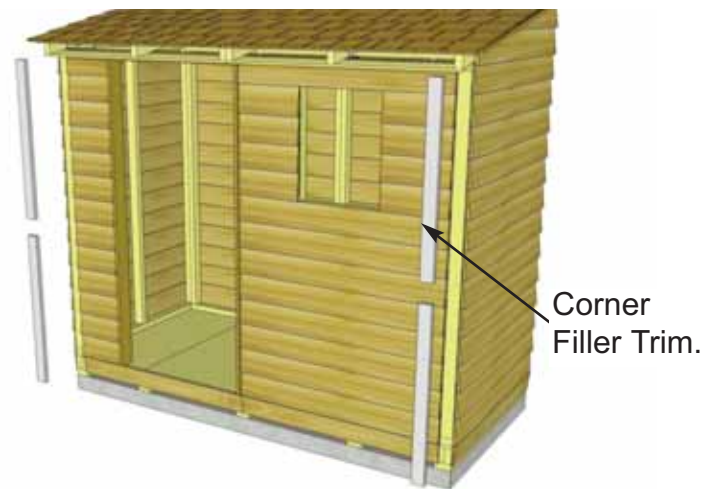
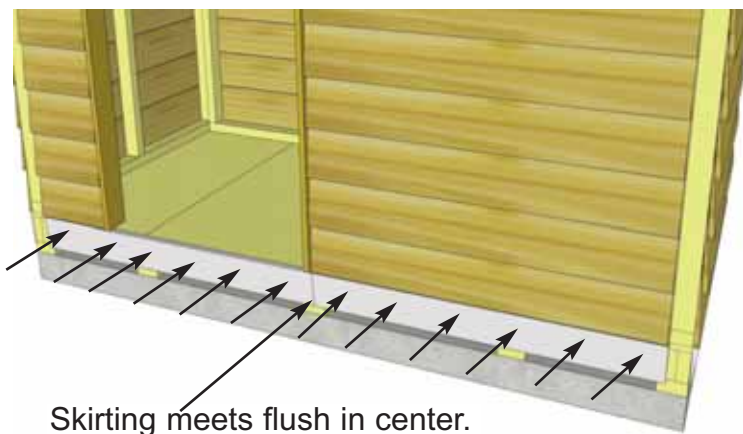

**50.** Use 6 nails on front skirting piece where doors will be installed. This adds extra support to a high traffic area.

**51.** Locate **Corner Filler Trims** (8 - 7/8" x 2 1/2" x 36") Fillers are essentially nailing strips and will not be visible once additional corner trims are attached later.

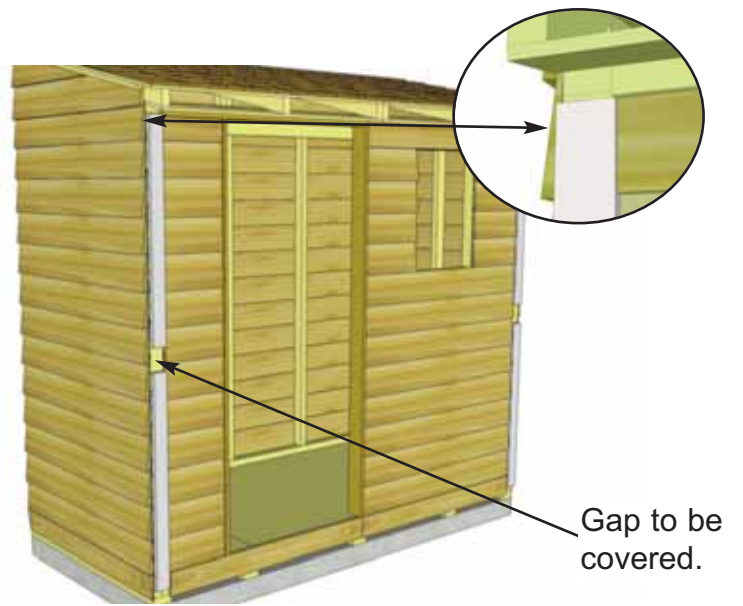
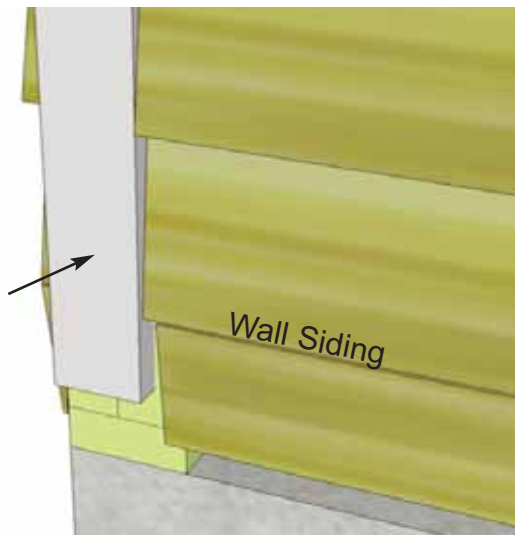

**52.** Attach **Corner Filler Trims** where gaps exist in front corners (2 per side). Hammer with 8 - 1 1/2" finishing nails. Position bottom filler just below wall siding. Top filler just below soffit. Gap in middle.

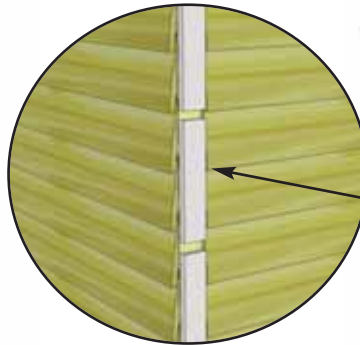

**53.** Position and attach Corner Filler Trims in the rear as per **Step 52**. There is an additional 10" long **Rear Center Corner Filler Trim** that you will need to center and attach as well using 2 - 1 1/2" nails.



**54.** To trim out window wall, locate **Top Window Wall Trim** (1 1/2" x 1 1/2" x 45 1/4"). Position at top of window wall up against roof soffit. Attach with 4- 1 1/2" finishing nails.

See **Step 65** before attaching Door Trim. Use Narrow Wall and Above Door Trim as a template to align trim.

Vertical Door Trim.

Flush with Narrow Wall stud.

Tight underneath soffit.

**55.** Locate **Vertical Door Trim** (2 - 1/2" x 3 1/2" x 79"). Position Door Trim flush with outside of narrow wall stud. Trim should be aligned tight underneath Soffit. Attach with 8 - 1 1/2" finishing nails.

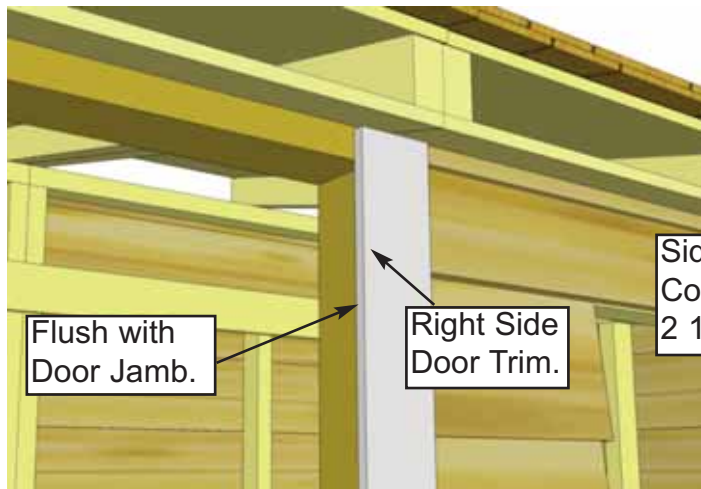

**56.** Position and attach opposite side Door Trim as per **Step 55**.

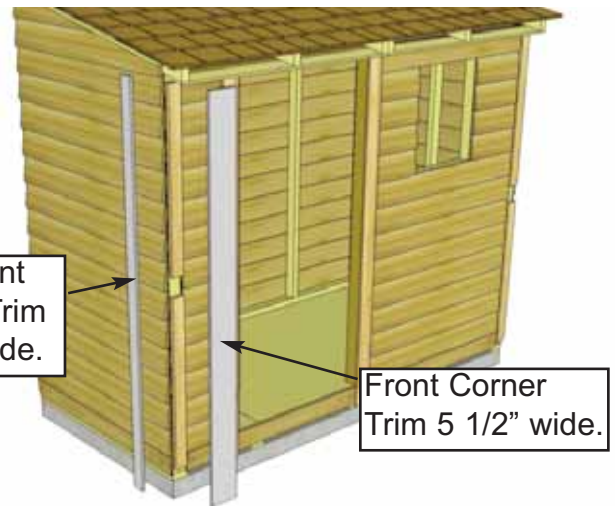

**57.** To completely trim out front corners, locate a **Side Front Corner Trim** (1/2" x 2 1/2" x 80") and a **Front Corner Trim** (1/2" x 5 1/2" x 79").

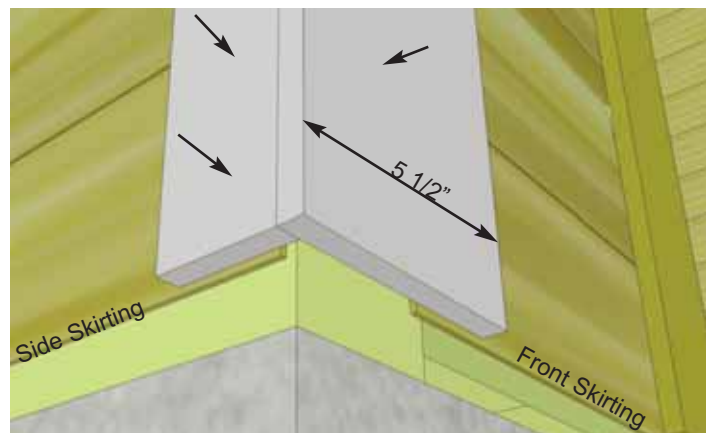
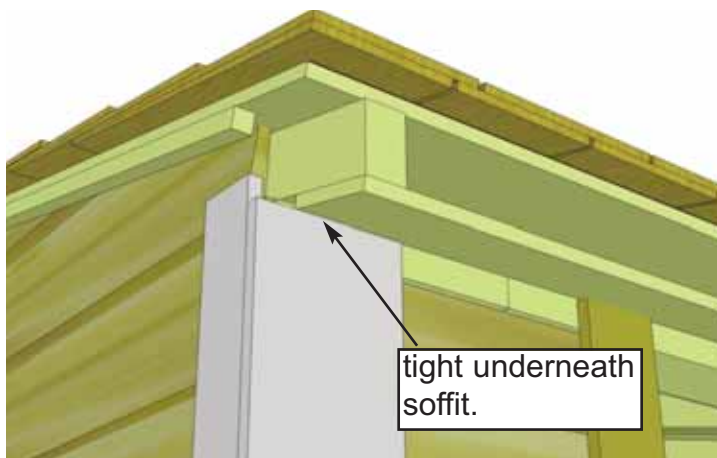

**58.** Place both trims in front corner and align as illustrated above. Do a dry run prior to attaching to achieve best fit. Start with 5 1/2" wide Front Corner Trim and align tight underneath soffit to determine vertical height. Attach with 8 - 1 1/2" finishing nails per piece. Position and attach Side Front Corner Trim (2 1/2" wide) using 8 - 1 1/2" nails, aligning at bottom with wide trim.

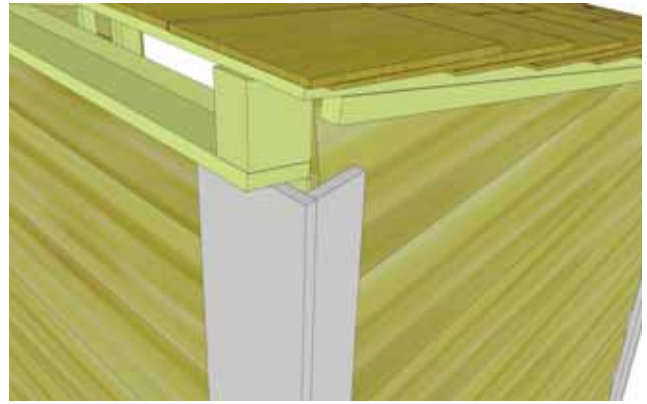

**59.** To completely trim out rear corners, locate **Side Rear Corner Trims** (1/2" x 2 1/2" x 88 3/4") and **Rear Corner Trims** (1/2" x 5 1/2" x 88 3/4"). Align and attach as per **Step 58**.

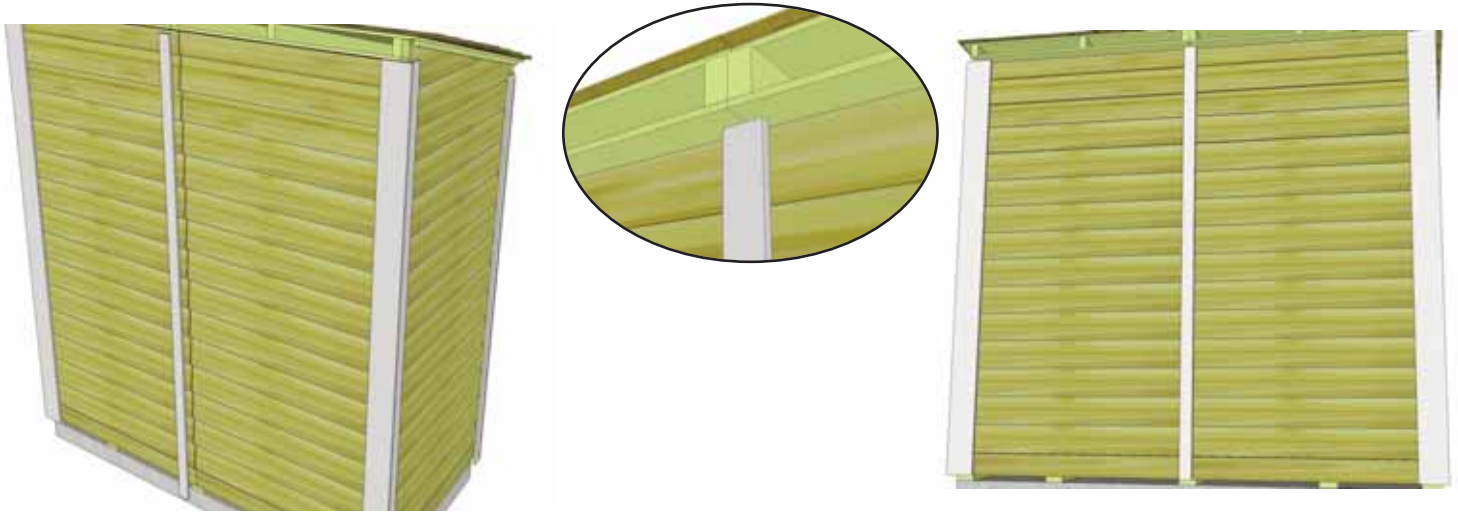

**60.** Attach **Rear Middle Trim** (1/2" x 2 1/2" x 88 3/4") where wall panels come together at rear seam. Attach with 8 - 1 1/2" finishing nails aligning tight underneath soffit and center on seam.

**Important - Drill Pilot Holes to prevent splitting.**

Attach Hinges with 3/4" & 2" Black Screws.

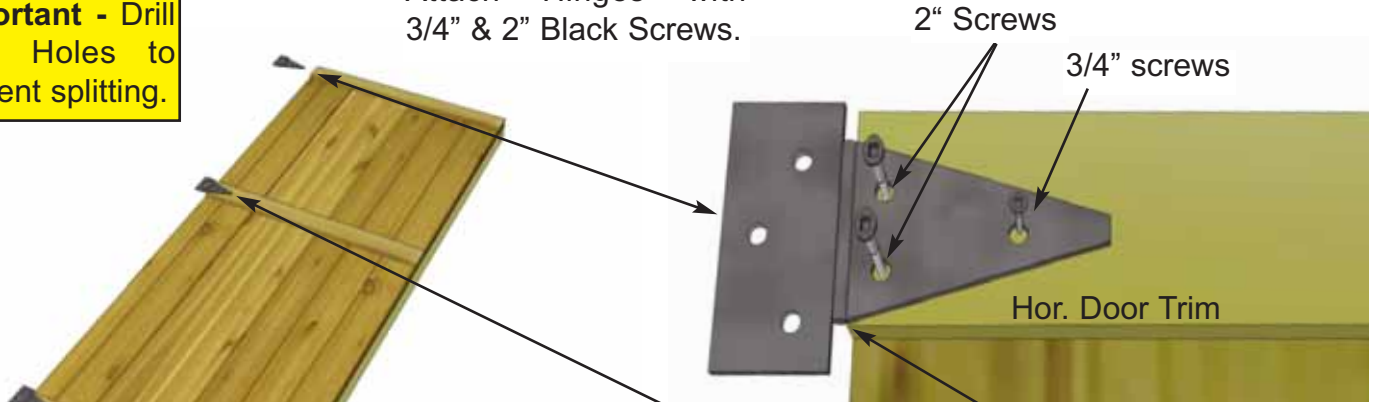

At top of door, align barrel of hinge closer to bottom of door trim as shown above. Center hinge on mid trim and at bottom, closer to the top of the door trim.

**61.** Attach Door Hinges to **Door**. Position Hinges equally on door trim as shown above and attach with Black 3/4" and 2" screws.





**Hint:** Use Shim Shingle or extra piece of siding to help space Door at top and bottom.



**62.** With Hinges attached, position door in opening. You will need some assistance to hold door in place.

**Important - Drill Pilot holes to prevent splitting.**

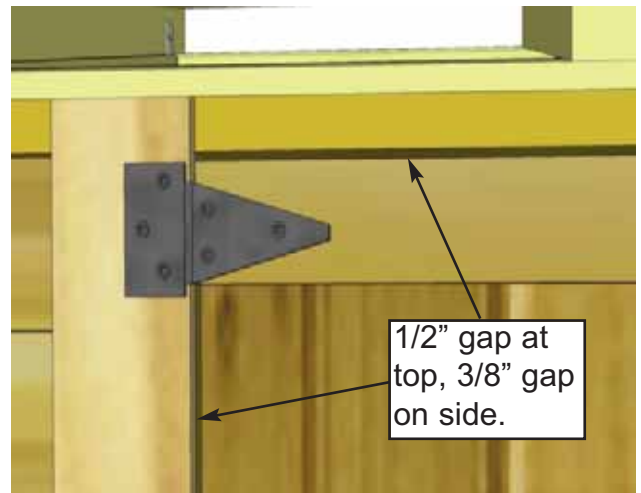
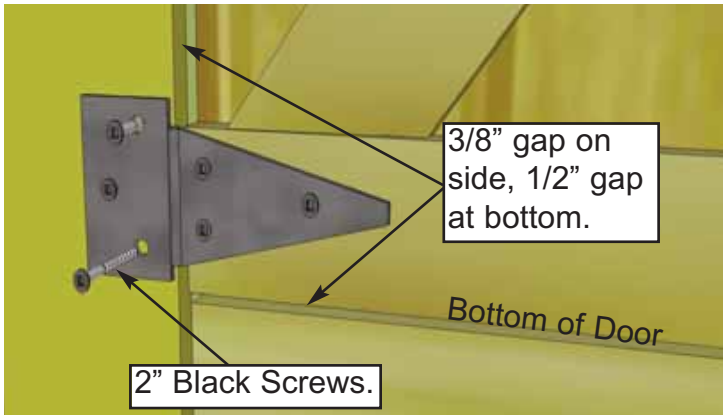

**64.** Once door is align in opening, position so there is a 1/2" gap on bottom, and approximately 3/8" on the side. Use a spare piece of siding or shingle to shim door in place at the bottom. Using 2" black screws, secure bottom hinge to Door Trim. **Hint:** Do not attach all the 2" screws until the door is positioned correctly. You can use a Screw Driver to tighten screws completely so you don't over tighten.

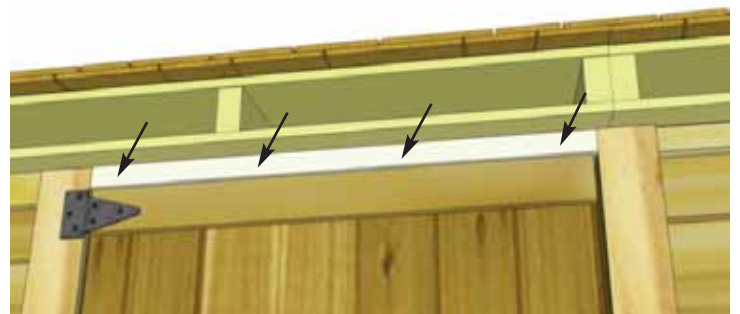
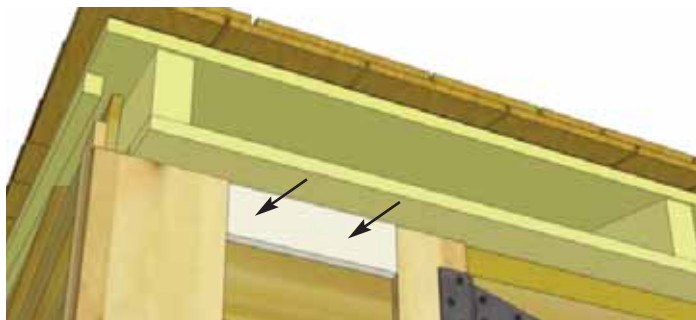

**65.** Position and attach **Narrow Wall Trim** (1/2" x 2 1/2" x 7 3/4") between corner and door trim underneath soffit. Attach with 2 - 1 1/2" finishing nails. Attach **Above Door Trim** (1/2" x 1 1/4" x 32") between door trims, underneath soffit and against door header. User 4 - 1 1/2" finishing nails.

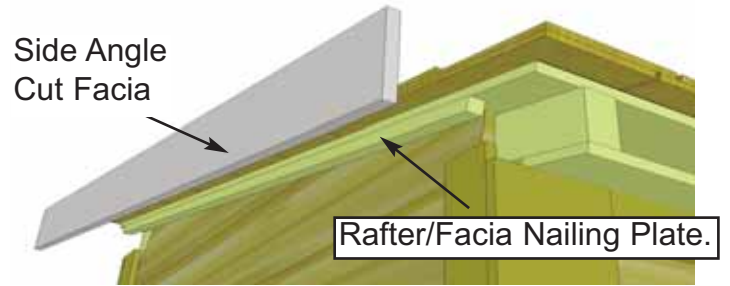
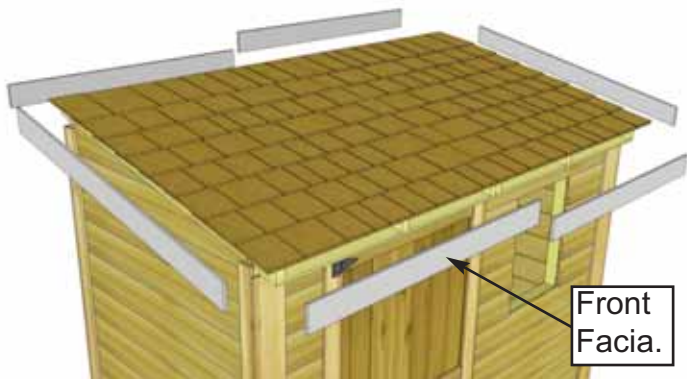

**66.** Locate and identify all Facia pieces: **Front & Rear Facia (4)** (1/2" x 4" x 50 1/2"). **Side Angle Cut Facia (2)** (1/2" x 4" x 54 1/8"). In front corner, align side and front Facia together. Front facia will cap side facia.

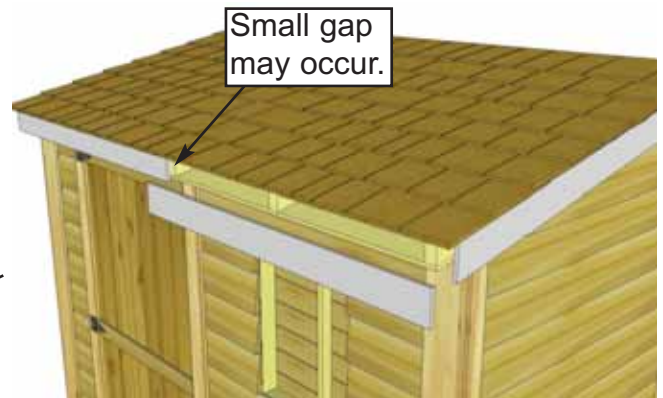
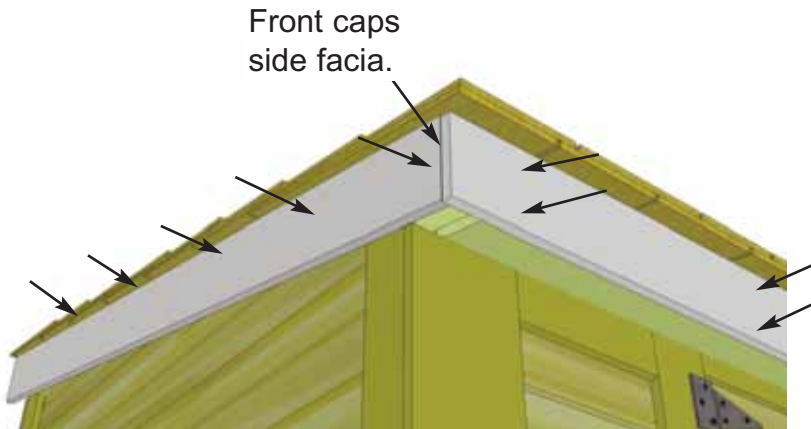

**67.** Do a dry run first before securing. Position Front Facia up underneath roof panel and against rafter ends. Have your helper hold in position. Place angle cut Side Facia underneath roof panel against Rafter/Facia Nailing Plate. Align so Front Facia caps Side Facia and then attach the front with 6 - 1 1/2" finishing nails. Attach side with 5 - 1 1/2" nails securing them into the nailing plate (closer to the top of the side facia board). Attach next piece of Front Facia. **Note:** With Front Facia correctly aligned at corners, a small gap may occur at center seam. This will be covered by Facia Detail Plate in **Step 70**.

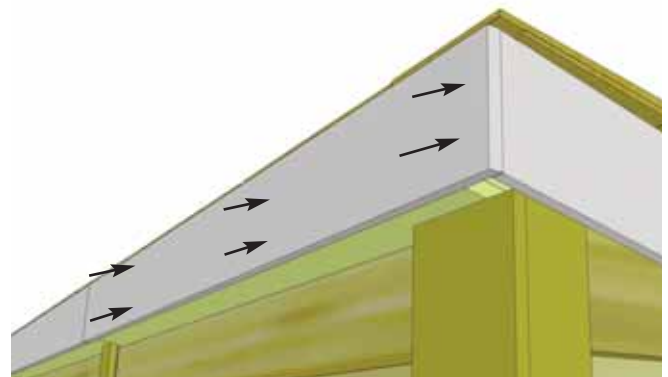
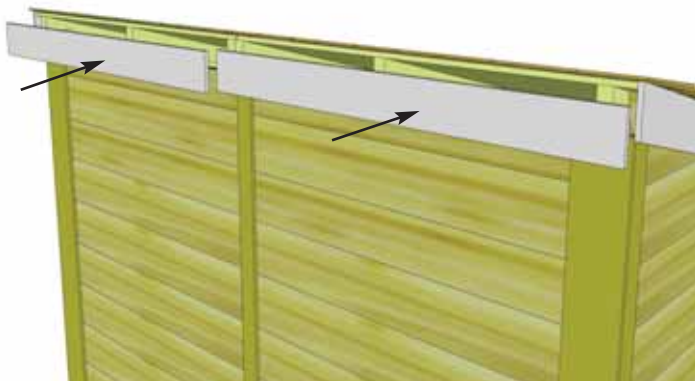

**68.** Place and align rear and side facia for best possible fit with rear capping side facia. Attach facia to rafter ends with 6 - 1 1/2" finishing nails per piece. Complete both rear facia pieces.

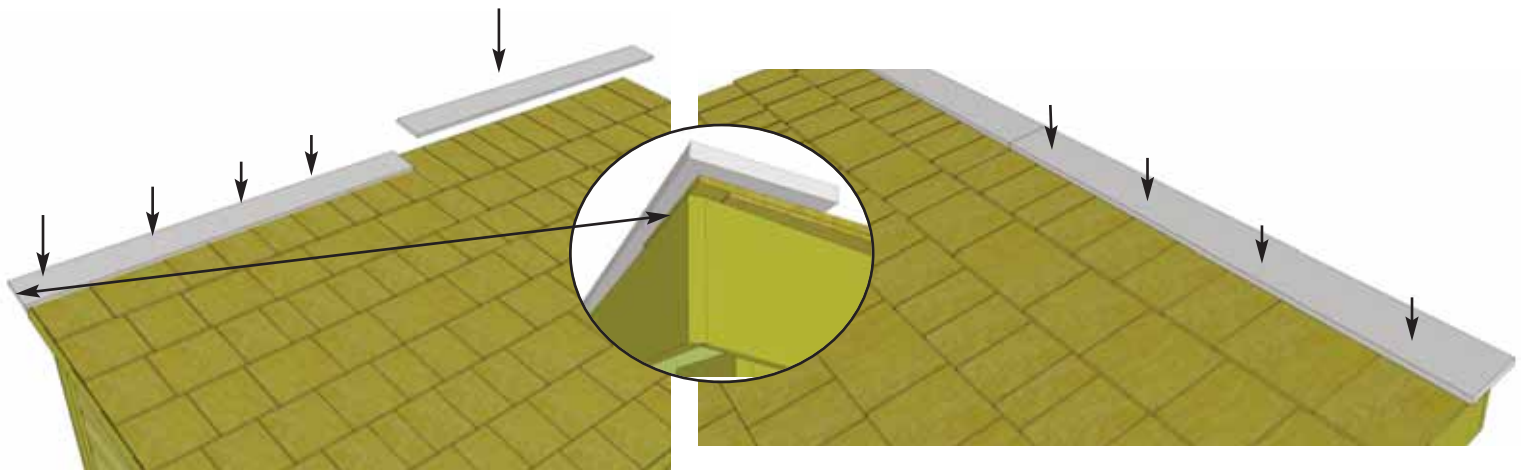

**69.** Position first **Roof Ridge Board** (1/2" x 4 1/2" x 51 5/8") at the rear of roof to cap off shingles and fascia. Ridge Boards should meet on seam of roof panels. When aligned correctly, attach with 4 - 1 1/2" nails per piece.

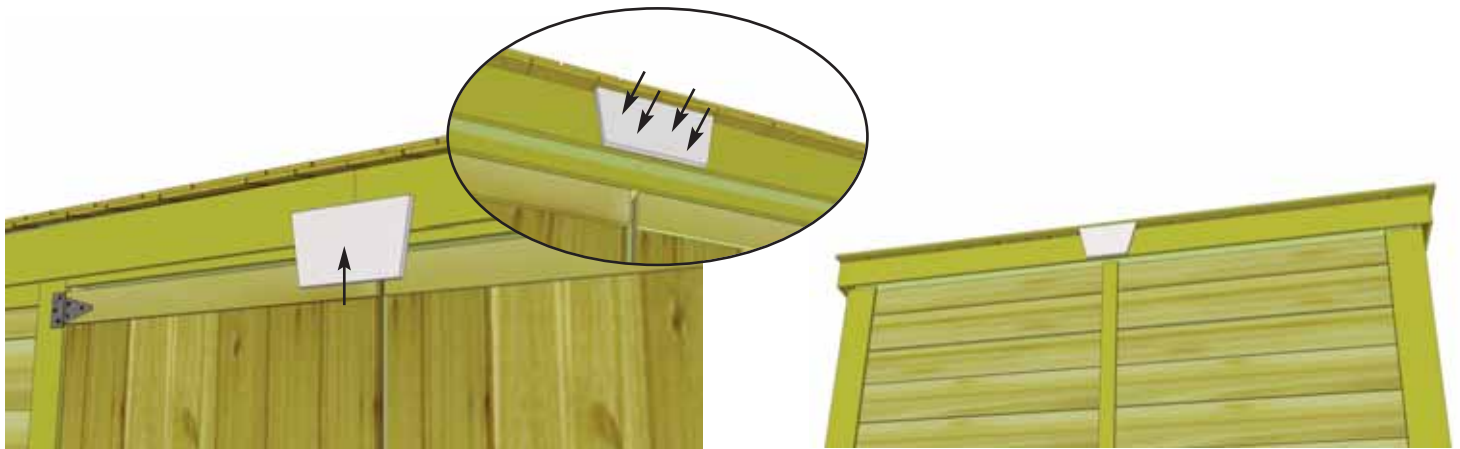

**70.** Attach **Facia / Detail Plates** to cover seams where Front and Rear Facia pieces come together. Secure with 4 - 1 1/2" finishing nails per piece.

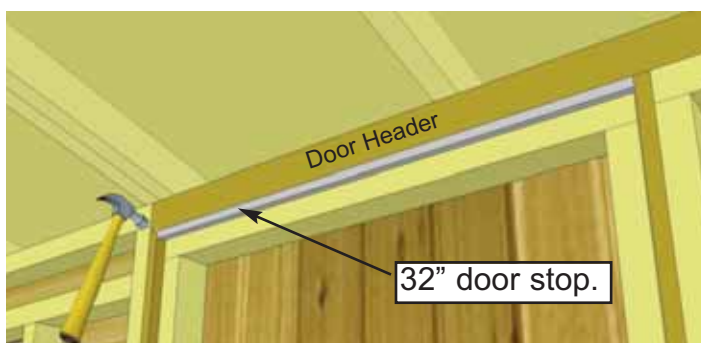

**71.** Attach **Upper Interior Door Stop** (1/2" x 1/2" x 32") positioning trim against door jamb and underneath door header flush to edges on inside as shown above. Attach with 4 - 1 1/2" finishing nails.

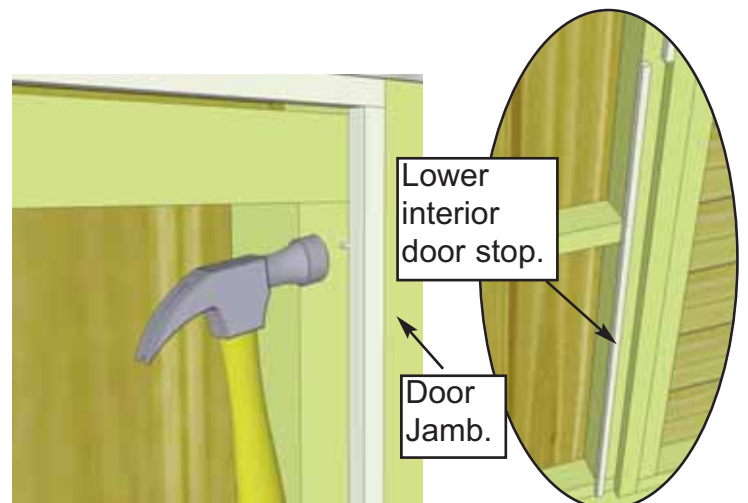

**72.** Attach upper and lower **Vertical Interior Door Stops** as per **Step 71**. Position against door jamb and underneath upper door trim. Attach with 4 - 1 1/2" finishing nails per piece. Complete both sides.

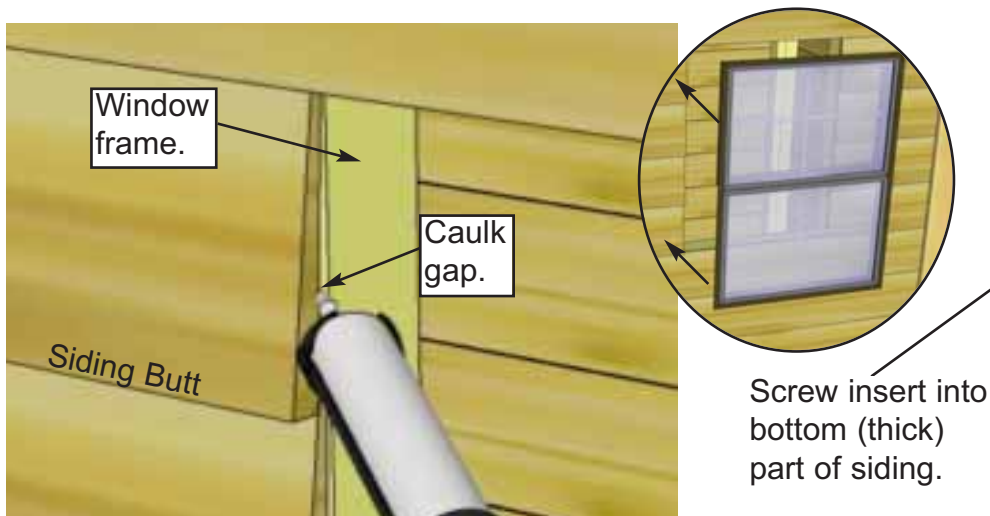

**73.** To reduce possible water from penetrating into the window cavity, caulk gap on both sides of window opening prior to installing **Window Insert**. Position insert in cavity and screw with 6 - 8 1 1/4" screws. On sides, make sure to screw insert into the thick butt of the siding only.

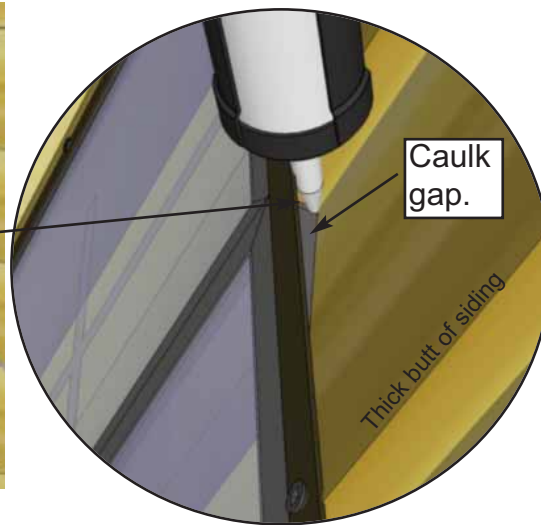
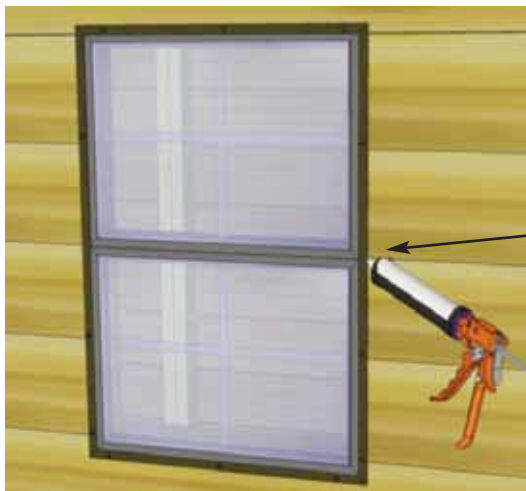

**74.** Once Insert is attached, caulk the "triangular gap" between the Insert's outside flange and the siding. Also put a bead of caulking horizontally at top of window where the flange and siding meet. This additional caulking will also will reduce the chances of moisture entering into your shed.

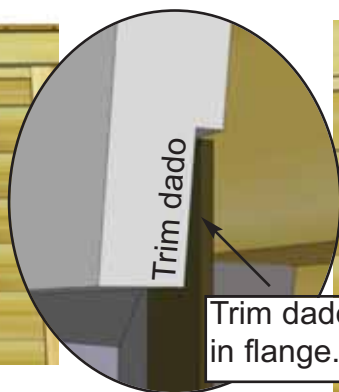

Trim dado sits in flange.



**75.** Position **Window Trim** around window doing a dry run first and attach with 4 - 1 1/2" finishing nails per piece. Trim Sizes = 1x 24 1/16" = top (angle cut on ends) / 3 x 23" = Sides & Bottom. Window trim has a small dado on reverse face. Outside flange of window will roughly sit in the dado to give a better fit.



**76.** Assemble Flower Box with Assembly Instructions included with this Manual. Center completed flower box below bottom of window trim and secure with 2 - 2 1/2" screws. Screw from inside of box into the center wall stud. Attach second screw 2" below first screw.



**77.** Attach **Door Handle**. Handle should be positioned with larger flange to top. Mount with 3/4" Black Headed Screws.

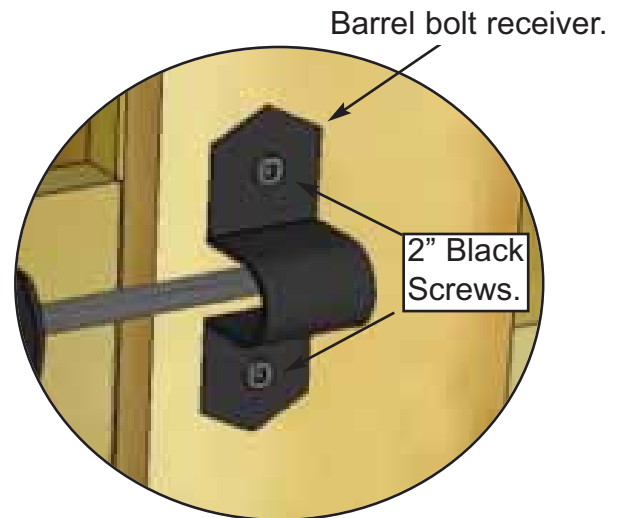
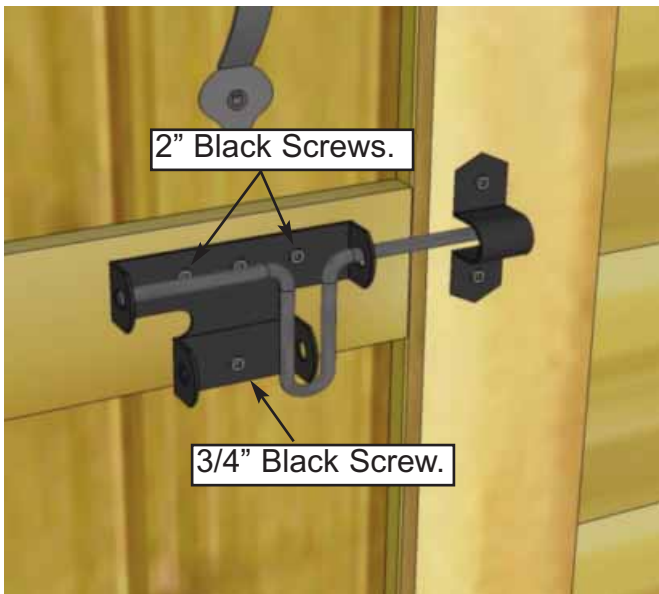

**78.** Attach Black Barrel Bolt as illustrated above with 2" & 3/4" Black Screws. Note how barrel bolt receiver is positioned higher than male. Do a dry run first to position Barrel Bolt correctly. **Important** - Drill pilot holes with 1/8" drill bit prior to securing with screws to prevent wood splitting. Drill shallow pilot hole only since the screw is only 3/4" long,

**Optional - Door Configuration on End Instructions. (New Door Jamb and Door Trim.)**

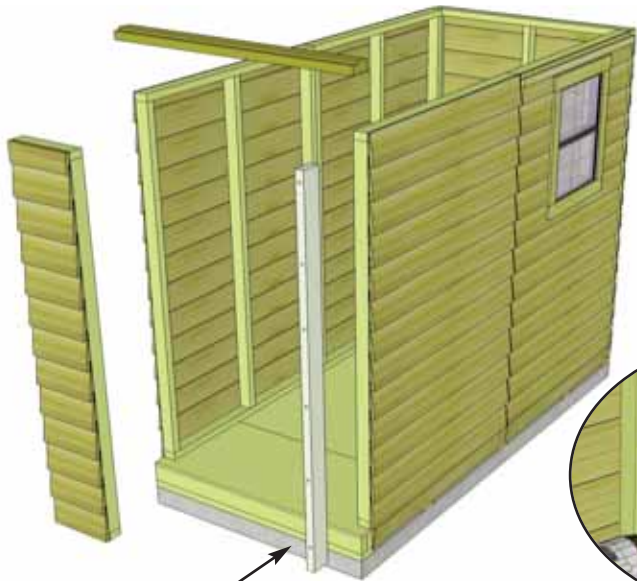

**79.** Install Narrow Wall as per **Step 17.**

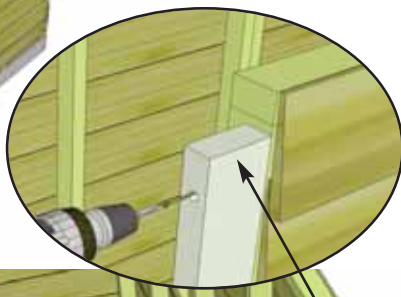
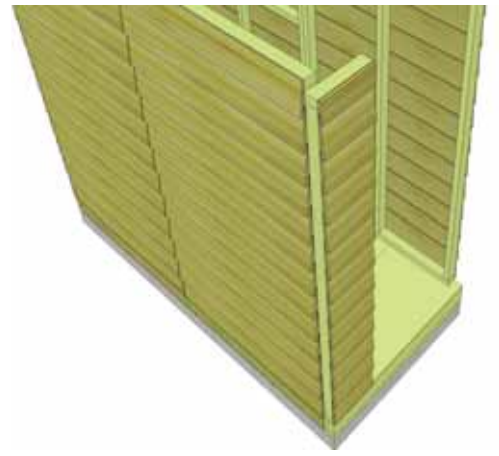

1 1/2" x 3 1/2" x 73"  
Optional Door Jamb.

**81.** Attach Door Header as per **Step 21.**

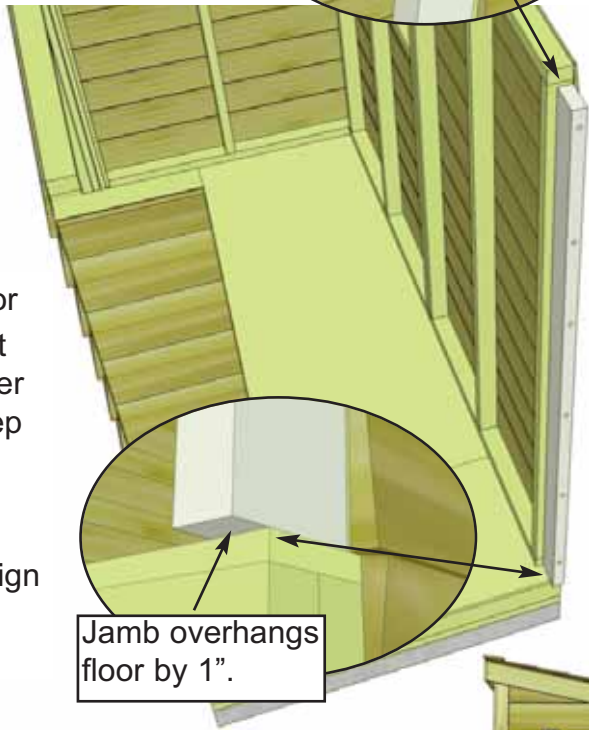

Jamb overhangs floor by 1".

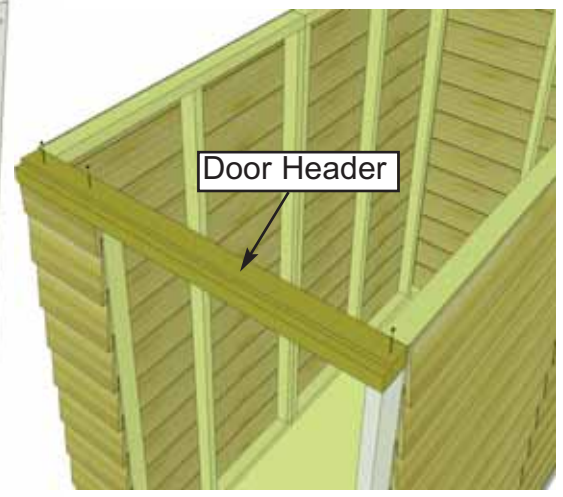

**80.** Position Optional Door Jamb as shown to the right using 6 - 4" screws. Counter sink holes in jamb 1/2" deep before screwing. Line up Jamb with outside of Side Wall Framing. Use Door Header (45 1/2" long) to align Jamb. Jamb will overhang floor at bottom.

Reg. Door Trim.

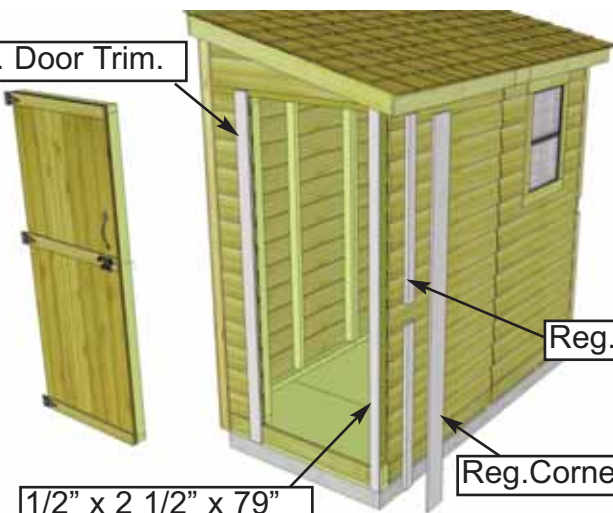

Reg. Filler Trim.

Reg. Corner Trim.

1/2" x 2 1/2" x 79"  
Optional Door Trim.

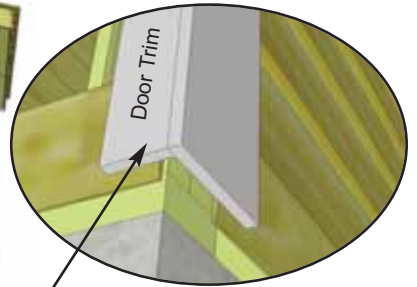

**82.** Install Reg. Door Trim and Hang Door as per **Step 55** and **Step 62.** Use Optional Trim (2 1/2" wide) on right side. Trim corner as per regular steps.



## Congratulations on completing your 8x4 SpaceSaver Shed!

**Note:** Our Sheds are shipped as unfinished products. If exposed to the elements, the Western Red Cedar lumber will weather to a silvery-gray color. If you prefer to keep the cedar lumber looking closer to the original color, we suggest that you treat the wood with a good wood stain. You may also wish to paint your new shed rather than stain it. In both cases we recommend that you consult with a paint and stain dealer in your area for their recommendations.



We value your feedback and would like to hear back from you on how well we are doing in the following areas:

1. Customer Service
2. On Time Shipping
3. Motor Freight Delivery
4. Quality of Materials
5. Assembly Manual
6. Overall Satisfaction.

Please call, write or email us at:

Outdoor Living Today

Canadian Address  
9393 287th Street  
Maple Ridge, British Columbia  
Canada V2W 1L1

United States Address  
P.O. Box 96  
Sumas, Washington  
USA 98295



The materials contained in this Assembly Manual may be downloaded or copied provided that ALL copies retain the copyright and any other proprietary notices contained on the materials. No material may be modified, edited or taken out of context such that its use creates a false or misleading statement or impression as to the positions, statements or actions.

**Toll Line: 1.888.658.1658**

**Fax: 1.604.462.5333**

**sales@outdoorlivingtoday.com**