

WARNINGS AND CAUTIONS:

- **TO AVOID FIRE SHOCK OR DEATH; TURN OFF POWER AT CIRCUIT BREAKER OR FUSE AND TEST THAT POWER IS OFF BEFORE WIRING!**
- **TO AVOID FIRE, PERSONAL INJURY OR PROPERTY DAMAGE, DO NOT** install to control a receptacle, a motor- or a transformer-operated appliance.
- To be installed and/or used in accordance with electrical codes and regulations.
- If you are unsure about any part of these instructions, consult an electrician.
- The Decora® DDL06 dimmer is not compatible with standard 3-Way or 4-Way switches. It must be used with a Decora® digital remote for multi-location control, such as the DD00R-DL.
- Maximum wire length from dimmer to all installed remotes cannot exceed 300 ft (90 m).

WARNINGS AND CAUTIONS:

- Dimmer may feel warm to the touch during normal operation.
- Recommended minimum wall box depth is 2-1/2".
- Use this device **WITH COPPER OR COPPER CLAD WIRE ONLY**.
- **Use with compatible dimmable LED, CFL or incandescent bulbs only.** For a list of compatible LED and CFL bulbs refer to www.leviton.com.
- When multiple bulbs are used with one dimmer **DO NOT** mix bulb types. All bulbs shall be either LED; CFL or incandescent. Using the same make/model of each bulb will enhance dimmer performance.

INTRODUCTION

The next generation of lighting control technology is here with the new Decora® Digital Dimmer with Bluetooth® Technology. This innovative device works using the Leviton Decora® Digital Dimmer & Timer app that can be easily downloaded to smartphones or tablets and paired to the Leviton Dimmer using Bluetooth® technology. Decora® Digital Devices give users point-to-point local control to automate lighting, bridging the gap between standard dimmers and whole-house automation systems.

The Decora® Digital Dimmer is a powerful device – combining the best of Leviton dimmer and timer functions with today's mobile technology for impressive results. The simple touch of a finger following the intuitive on-screen guide makes it more convenient than ever to manage lighting for home activities or to ensure a "lived-in" look while away. Plus, the Decora® Digital Dimmer is Universal and compatible with LED, CFL or Incandescent bulbs.

Use of the app allows greater flexibility for accurate timer functionality and makes pushing buttons for timed events a tedious chore of the past.

The Leviton Decora® Digital Dimmer & Timer app can be easily downloaded to mobile devices and is compatible with Android and iOS smartphones or tablets. The app is easy to use with simple, intuitive on-screen menu options to independently control dimmers and switches throughout the home.

Decora® Digital Devices are ideal for living rooms, bedrooms, kitchens, dining rooms, home offices, outdoor lighting or anywhere full control of lighting is desired.

COMPATIBILITY

- Requires device with Bluetooth® 4.0 (BT LE) or later.
- iOS 6.0 and later. Compatible with iPhone, iPad, and iPod touch.
- Android 4.0 and later.

FEATURES

- Soft fade ON/OFF
- ON/OFF LED and Brightness level LED
- Three way communication
- Ease of installation - No new wiring

TOOLS NEEDED TO INSTALL YOUR DIMMER

- Slotted/Phillips Screwdriver
- Electrical Tape
- Pliers
- Pencil
- Cutters
- Ruler

Changing the color of your Dimmer:

Your device may include color options. To change color of the face proceed as follows:

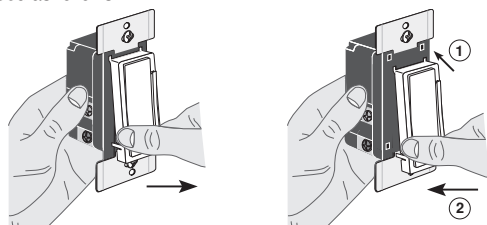

Push in sides at bottom tabs and pull outward to release

Insert top tabs and press in bottom tabs to attach

INSTALLING DIMMER BY ITSELF OR WITH OTHER DEVICES

If installing Dimmer in a single device application, proceed with the **INSTALLING YOUR DIMMER** section. If installing Dimmer in a multi-device application, proceed as follows:

MULTI-DEVICE APPLICATION

In multi-dimmer installations, the reduction of the dimmer's capacity may be required. Refer to the chart for maximum load per dimmer.

NOTE: No derating is required for LED or CFL bulb applications.

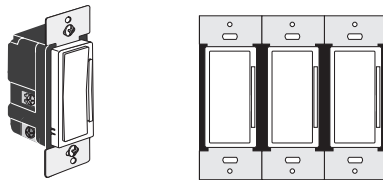

MAXIMUM LOAD PER DIMMER FOR MULTI-DEVICE			
Load	Single	Two Devices	More than 2 Devices
Incand	600W	500W	500W

INSTALLING YOUR DIMMER

NOTE: Use check boxes when Steps are completed.

Step 1 **WARNING: TO AVOID FIRE SHOCK OR DEATH; TURN OFF POWER** at circuit breaker or fuse and test that power is off before wiring!

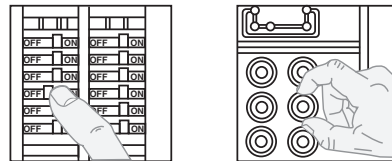

Step 2 **Identifying your wiring application (most common):**

NOTE: If the wiring in your wall box does not resemble any of these configurations, consult an electrician.

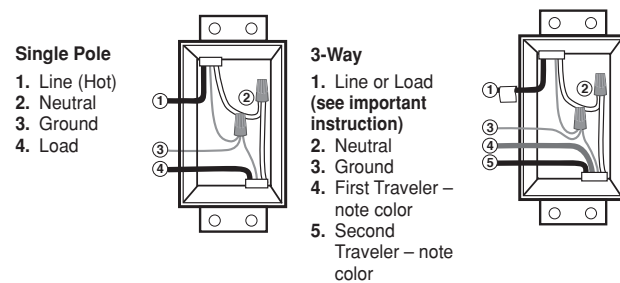

IMPORTANT: For 3-Way applications, note that one of the screw terminals from the old switch being removed will usually be a different color (Black) or labeled Common. Tag that wire with electrical tape and identify as the common (Line or Load) in both the dimmer wall box and remote wall box.

Step 3 **Preparing and connecting wires:**

This dimmer can be wired using side wire terminal screws or through backwire openings. Choose appropriate wire stripping specifications accordingly.

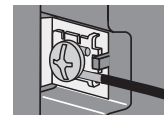
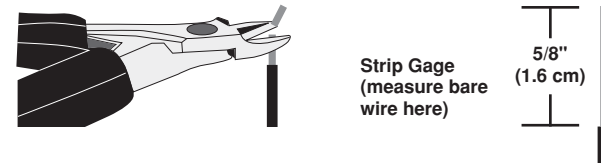

Side Wire Connection
 Side wire terminals accept #14-12 AWG solid copper wire only.

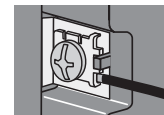

Back Wire Connection
 Back wire openings accept #14-12 AWG solid copper wire only.

- Make sure that the ends of the wires from the wall box are straight (cut if necessary).
- Remove insulation from each wire in the wall box as shown.
- **For Single-Pole Application, go to Step 4a.**
- **For 3-Way Matching Remote (with LEDs) Application, go to Step 4b.**

For non-standard wiring applications, refer to Wire Nut and Connector Size Chart

WIRE CONNECTOR / # OF COND. COMBINATION CHART

- 1 - #12 w/ 1 to 3 #14, #16 or #18
- 2 - #12 w/ 1 or 2 #16 or #18
- 1 - #14 w/ 1 to 4 #16 or #18
- 2 - #14 w/ 1 to 3 #16 or #18

Step 4a **Single Pole Wiring Application:**

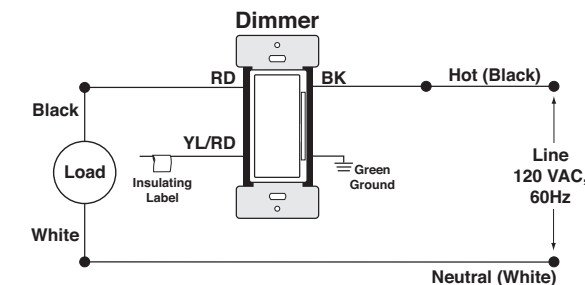
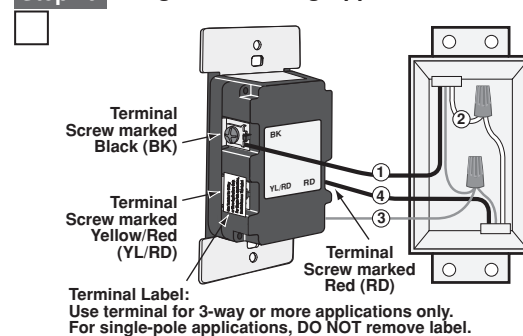

WIRING DIMMER:

Connect wires per WIRING DIAGRAM as follows:

- NOTE:** The DDL06 dimmer requires a ground connection.
- Green or bare copper wire in wall box to Green dimmer terminal screw.
 - Line Hot wall box wire to Black dimmer terminal screw.
 - Load wall box wire to Red dimmer terminal screw.
 - Yellow/Red dimmer terminal screw should have Red insulation label affixed.
 - **NOTE:** If insulating label is not affixed to Yellow/Red dimmer terminal screw, use electrical tape to cover.
 - **Proceed to step 5.**

Step 4b **3-Way Wiring with DD00R Matching Remote (with LED) Application:**

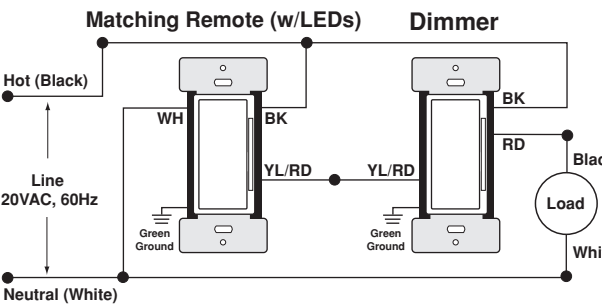
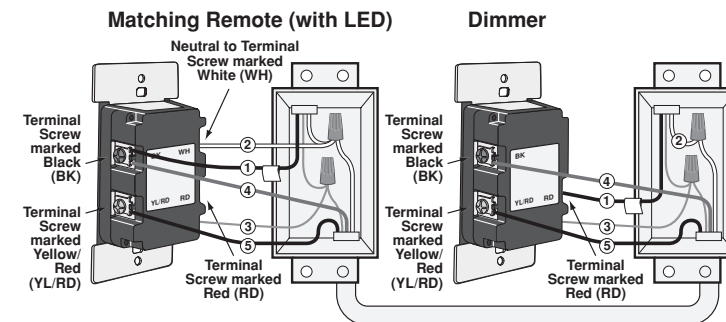

WIRING MATCHING REMOTE (wall box with Line Hot connection):
Connect wires per WIRING DIAGRAM as follows:

NOTE: The matching remote must be installed in a wall box with a Line Hot connection and a Neutral connection. A Neutral wire to the matching remote needs to be added as shown. If you are unsure about any part of these instructions, consult an electrician.

NOTE: Maximum wire length from dimmer to all installed remotes cannot exceed 300 ft (90m).

- Green or bare copper wire in wall box to Green terminal screw.
- Line Hot (common) wall box wire identified (tagged) when removing old switch and First Traveler to remote terminal screw marked "BK".
- Second Traveler wall box wire from dimmer to remote terminal screw marked "YL/RD" (**note wire color**). This traveler from the remote must go to the terminal screw on the dimmer marked "YL/RD".
- Line Neutral wall box to remote terminal screw marked "WH".

WIRING DIMMER (wall box with load connection):
Connect wires per WIRING DIAGRAM as follows:

NOTE: The dimmer must be installed in a wall box that has a Load connection. The dimmer also requires a ground connection.

- Green or bare copper wire in wall box to Green terminal screw.
- Load wall box wire identified (tagged) when removing old switch to dimmer terminal screw marked "RD".
- First Traveler Line Hot to dimmer terminal screw marked "BK".
- Remove Red insulating label from terminal screw marked "YL/RD".
- Second Traveler wall box wire (**note color as above**) to dimmer terminal screw marked "YL/RD". This traveler from the dimmer must go to the terminal screw on the remote marked "YL/RD".

NOTE: To synchronize LEDs between a Decora® digital remote and the Decora® DDL06 dimmer, a dim up or dim down command must be pressed on the remote.

- **Proceed to Step 5.**

Step 5 **Testing your Dimmer prior to mounting in wall box:**

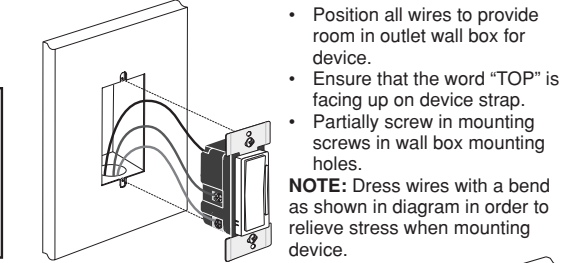

- Position all wires to provide room in outlet wall box for device.
- Ensure that the word "TOP" is facing up on device strap.
- Partially screw in mounting screws in wall box mounting holes.
- **NOTE:** Dress wires with a bend as shown in diagram in order to relieve stress when mounting device.

Step 6 **Dimmer Mounting: TURN OFF POWER AT CIRCUIT BREAKER OR FUSE.**

Installation may now be completed by tightening mounting screws into wall box. Attach wallplate.

Step 7 **Restore Power:**
 Restore power at circuit breaker or fuse.
Installation is complete.

NOTE: To pair your dimmer with your mobile device, download the Leviton Decora® Digital Dimmer and Timer app from the Google Play Store or your iTunes account. Contact Leviton's Techline at 1-800-824-3005 or visit Leviton's website at www.leviton.com for additional information.

OPERATION

NOTE: The locator light will illuminate when the load is in the OFF position to facilitate access in the dark.

NOTE: If using the dimmer in a 3-way application, the lights will turn ON at brightness set on dimmer's DIM/BRIGHT bar. The lighting can be controlled from either the dimmer, the remote location or the mobile device app.

Push Pad (Default settings)

Turn ON from OFF position:

Tap TOP of Rocker: Lights turn ON to preset level.

Turn OFF from ON position:

Tap BOTTOM of Rocker. Lights turn OFF.

DIM/BRIGHT Bar

BRIGHTEN:

Press the TOP half of the DIM/BRIGHT Bar – Lights brighten to desired level.

DIM:

Press the BOTTOM half of the DIM/BRIGHT Bar – Lights dim to desired level. If you continue to hold, the lights will DIM to minimum level and then turn OFF.

NOTE: When lights are OFF you can change the light level that the lights will turn ON to using the DIM/BRIGHT Bar. If there is a power outage, when the power is restored, the lights will return to the last setting before the power interruption.

Air-Gap Switch: On the dimmer only, engage the air-gap switch by gently pulling out from the bottom of the DIM/BRIGHT bar until the bottom of the bar lifts completely out of the frame and a click is heard (**refer to Figure**). LED's will turn OFF. This will stop power to the fixture to replace the bulb. After servicing is complete, press the DIM/BRIGHT Bar back into place for normal operation.

Cleaning: Clean with a damp cloth. **DO NOT** use chemical cleaners.

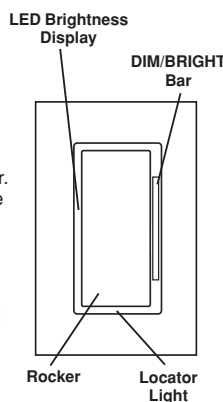

CONTROLLING YOUR DIMMER WITH BLUETOOTH®

Download the Leviton Decora® Digital Dimmer & Timer App for your device.

Android: Tap the Google Play Store icon on your phone or go to <http://play.google.com> on your computer and follow the instructions to obtain the app.

iPhone: Tap the App Store icon on your phone or access the app through your iTunes account on your computer.

Once you have downloaded the app, follow the instructions on the screen to pair your mobile device with your dimmer. Once your mobile device is paired, use the following options to control your dimmer:

- **On - Off:** Turns the dimmer ON and OFF.
- **Schedule:** Creates distinct ON/OFF events based on time and day.
- **Sleep Timer:** Sets countdown to turn dimmer OFF.

Advanced Settings

Bulb Options

- **Load Type:** Sets load type to Incandescent, LED or CFL.
- **Fade On:** Sets the amount of time for the lights to turn ON to maximum brightness.
- **Fade Off:** Sets the amount of time for the lights to turn to OFF from maximum brightness.

Device Options

- **Randomized Scheduled Events:** Cycles lights ON and OFF to ensure a "lived-in" look while away.
- **Hide LED Dim Bar:** Turns LED Dim Bar OFF.
- **Hide Status LED:** Turns Status LED OFF.
- **DST Offset Hours:** Adjusts the Sunrise/Sunset time in hours.
- **DST Offset Minutes:** Adjusts the Sunrise/Sunset time in minutes.

Lighting Options

- **Preset:** Sets the brightness level at which the lights turn ON.
- **Minimum:** Sets a minimum brightness level for lighting.
- **Maximum:** Sets a maximum brightness level for lighting.

MANUAL PROGRAMMING FEATURES

Definition of A Modes

- A-1) Load Type Selection**
- A-2) Energy Save:** Sets the maximum brightness level for energy savings.
- A-3) Minimum Brightness Level:** Sets the minimum dimming level.
- A-4) Preset ON Level:** Sets the turn on brightness level regardless of the previous set light level.

Definition of B Modes

- B-1) ON Fade Rate:** Sets the amount of time in seconds it takes the lights to turn ON to maximum brightness.
- B-2) OFF Fade Rate:** Sets the amount of time in seconds it takes the lights to turn OFF from maximum brightness.
- B-3) LED Options:** Sets the time period in seconds the Locator LED and Brightness display will stay on before extinguishing.

Definition of LEDs

Bottom LED = LED 1
Top LED = LED 7

NOTES:

- The device will exit programming mode after 3 minutes of inactivity.
- Pressing the TOP of the Rocker at any time during programming will advance the device to the next programming mode.

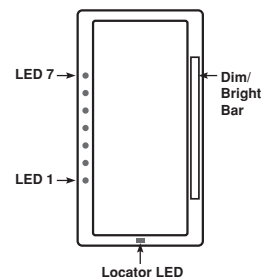

Program Mode A

To enter Program Mode A:

Press and hold the TOP of the Rocker and the TOP of the DIM/BRIGHT Bar simultaneously for 5 seconds until the Locator LED begins to blink.

- A-1)** Upon releasing the TOP of the Rocker and the TOP of the DIM/BRIGHT Bar, the Locator LED will continue to blink once per second to display the device is in Program Mode **A-1, Load Type Selection**. The bottom LED will illuminate to display that the Load Type selected is Incandescent (default load type). To change the load type, use the DIM/BRIGHT Bar to change the corresponding LED to the desired load type according to the **Load Type Chart** below. By tapping the TOP of the Rocker, this setting will automatically be saved and the device will advance to the next Programming Mode, **A-2, Energy Save (Maximum Brightness Level)**.

LOAD TYPE CHART	
When indicator is at LED #	Selected Load Type is
1	Incandescent
2	LED
3	CFL

- A-2) Maximum Brightness Level:** **NOTE** - The Locator LED will blink 2 times per second to indicate the device is in Program Mode **A-2, (Maximum Brightness Level)**. The default **Maximum Brightness Level** is LED 7, representing 100% light output i.e. full brightness. To change the **Maximum Brightness** level from 100% to the desired output level, use the DIM/BRIGHT bar. The **Maximum Brightness** level can be changed from LED # 7, representing maximum light output, to LED #4, representing minimum light output. By tapping the TOP of the Rocker this setting will automatically be saved and the device will advance to the next Programming Mode, **A-3, Minimum Brightness Level**.

- A-3)** The Locator LED will blink 3 times per second to indicate the device is in Program Mode **A-3, Minimum Brightness Level**. The default Minimum Brightness Level is LED 2. To change the **Minimum Brightness Level** from 1-50%, use the DIM/BRIGHT Bar. The light output will reflect the minimum brightness level selected. By tapping the TOP of the Rocker this setting will automatically be saved and the device will advance to the next programming mode, **A-4, Preset ON Level**.

- A-4)** The Locator LED will blink 4 times per second to indicate Program Mode **A-4, Preset ON Level**. To change the current **Preset ON Level** from 1-100%, use the DIM/BRIGHT Bar. If this feature is not desired, press and hold the BOTTOM half of the DIM/BRIGHT Bar until LED 1 is lit, and then keep holding for another two seconds (default setting). By tapping the TOP of the Rocker this setting will automatically be saved and the device will exit Programming Mode **A**.

Program Mode B

To enter Program Mode B:

Press and hold the TOP of the Rocker and then the BOTTOM of the DIM/BRIGHT Bar for 5 seconds until the Locator LED and the TOP LED (LED 7) begin to blink.

- B-1)** Upon releasing the TOP of the Rocker and the BOTTOM of the DIM/BRIGHT Bar, the Locator LED will continue to blink once per second indicating the dimmer is in Program Mode **B-1, ON Fade Rate**. To change the **ON Fade Rate**, use the DIM/BRIGHT Bar to move the LED to the desired preset level according to the **Fade Rate Chart**. By tapping the Top of the Rocker this setting will automatically be saved and the device will advance to the next programming mode, **B-2, OFF Fade Rate**.

- B-2)** The Locator LED will blink 2 times per second to indicate Program Mode **B-2, OFF Fade Rate**. To change the **OFF Fade Rate**, use the DIM/BRIGHT Bar to move the LED to the desired preset level according to the **Fade Rate Chart**. By tapping the TOP of the Rocker this setting will automatically be saved and the device will advance to the next programming mode, **B-3 LED Options**.

FADE RATE CHART		
LED	Fade ON	Fade OFF
1	0 seconds (instant)	0 seconds (instant)
2	0.5 seconds	0.5 seconds
3	1.5 seconds	1.5 seconds
4	3 seconds	3 seconds
5	6 seconds	6 seconds
6	10 seconds	10 seconds
7	25 seconds	25 seconds

- B-3)** The Locator LED will blink 3 times per second to indicate Program Mode **B-3, LED Options**. To change the **LED Options** settings, use the DIM/BRIGHT Bar to move the LED to the desired preset setting according to the **LED Options Chart**. By tapping the Top of the Rocker this setting will automatically be saved and the device will exit Programming Mode B.

LED OPTIONS CHART		
LED	Locator LED Timeout	LED Brightness Display Options
1	Active	Active
2	Active	Turns OFF 5 seconds after use
3	Turns OFF 5 seconds after use	Active
4	Turns OFF 5 seconds after use	Turns OFF 5 seconds after use
5	N/A	N/A
6	N/A	N/A
7	N/A	N/A

TROUBLESHOOTING

- **Lights Flickering**
 - Lamp has a bad connection.
 - Wires not secured firmly with terminal screws of dimmer or terminal screws of remote.
 - If using in a dimmable fluorescent application see Advanced Programming Feature A-1.
- **Light does not turn ON and Locator LED does not turn ON**
 - Circuit breaker or fuse has tripped.
 - Lamp is burned out.
 - Ground not wired to dimmer.
 - Confirm that the device is being supplied from a 120V, 60Hz AC source ONLY.
- **Intermittent dimmer operation**
 - Confirm that the Load being controlled does not exceed the 600W dimmer limit.
- **Remote does not operate lights**
 - Ensure that total wire length does not exceed 300 ft.
 - Ensure wiring is correct.

FACTORY DEFAULT

If your dimmer is not responding, or you are unable to control it after you have tried to Pair/Connect to it multiple times, it may be necessary to reset the dimmer to its original factory settings. To accomplish this, proceed as follows:

On the dimmer, hold the TOP of the rocker until the locator LED starts to blink. The dimmer is now reset. Once the dimmer is reset, it may be necessary to re-pair with the smartphone application.

For additional information, contact Leviton's Techline at 1-800-824-3005 or visit Leviton's website at www.leviton.com

This product is covered by U.S. Patent No. 8,664,886 and corresponding foreign patents.

FCC COMPLIANCE STATEMENT

This device complies with Part 15 of the FCC Rules. Operation is subject to following two conditions: (1) this device may not cause harmful interference, and (2) this device must accept any interference received, including interference that may cause undesired operation of the device. This equipment has been tested and found to comply with the limits for a Class B Digital Device, pursuant to Part 15 of the FCC Rules. These limits are designed to provide reasonable protection against harmful interference in a residential installation. This equipment generates, uses, and can radiate radio frequency energy and, if not installed and used in accordance with the instructions, may cause harmful interference to radio communications. However, there is no guarantee that interference will not occur in a particular installation. If this equipment does cause harmful interference to radio or television reception, which can be determined by turning the equipment OFF and ON, the user is encouraged to try to correct the interference by one or more of the following measures:

- Reorient or relocate the receiving Antenna.
- Increase the separation between the equipment and the receiver.
- Connect the equipment into an outlet on a circuit different from that to which the receiver is connected.
- Consult the dealer or an experienced radio/tv technician for help.

FCC CAUTION

Any changes or modifications not expressly approved by Leviton Manufacturing Co., Inc., could void the user's authority to operate the equipment.

IC COMPLIANCE STATEMENT

This device complies with Industry Canada licence-exempt RSS standard(s). Operation is subject to the following two conditions: (1) this device may not cause interference, and (2) this device must accept any interference, including interference that may cause undesired operation of the device.

Copyright and Trademark Information

The Bluetooth® word mark and logos are registered trademarks owned by Bluetooth SIG, Inc., used under license by Leviton. Use herein of third party trademarks, service marks, trade names, brand names and/or product names are for informational purposes only, are/may be the trademarks of their respective owners; such use is not meant to imply affiliation, sponsorship, or endorsement.

No part of this document may be reproduced, transmitted or transcribed without the express written permission of Leviton Manufacturing Co., Inc.

FOR CANADA ONLY

For warranty information and/or product returns, residents of Canada should contact Leviton in writing at **Leviton Manufacturing of Canada Ltd to the attention of the Quality Assurance Department, 165 Hymus Blvd, Pointe-Claire (Quebec), Canada H9R 1E9** or by telephone at **1-800-405-5320**.

LIMITED 5 YEAR WARRANTY AND EXCLUSIONS

Leviton warrants to the original consumer purchaser and not for the benefit of anyone else that this product at the time of its sale by Leviton is free of defects in materials and workmanship under normal and proper use for five years from the purchase date. Leviton's only obligation is to correct such defects by repair or replacement, at its option. **For details visit www.leviton.com or call 1-800-824-3005.** This warranty excludes and there is disclaimed liability for labor for removal of this product or reinstallation. This warranty is void if this product is installed improperly or in an improper environment, overloaded, misused, opened, abused, or altered in any manner, or is not used under normal operating conditions or not in accordance with any labels or instructions. **There are no other or implied warranties of any kind, including merchantability and fitness for a particular purpose,** but if any implied warranty is required by the applicable jurisdiction, the duration of any such implied warranty, including merchantability and fitness for a particular purpose, is limited to five years. **Leviton is not liable for incidental, indirect, special, or consequential damages, including without limitation, damage to, or loss of use of, any equipment, lost sales or profits or delay or failure to perform this warranty obligation.** The remedies provided herein are the exclusive remedies under this warranty, whether based on contract, tort or otherwise.