

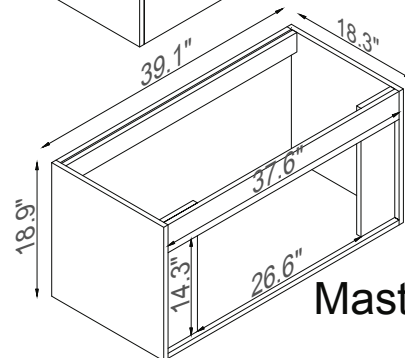

Streamline

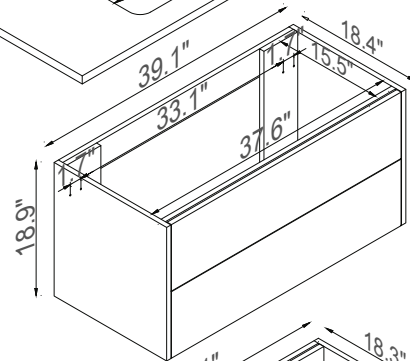
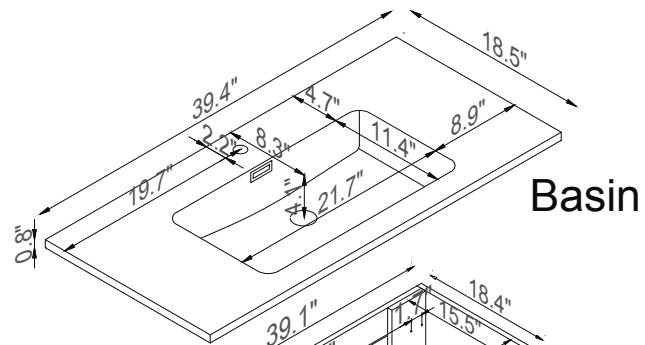

K1500-161-40-51