

# Owner's **MANUAL**



TEPPANYAKI

**MY HIBACHI B.B.Q.**

OUTDOOR GRILLING INNOVATIONS LLC

*Changing The Way America Grills*





My Hibachi BBQ 3-in-1 is the newest and most innovative gas grill in the market today. This portable, collapsible and decorative masterpiece is a teppanyaki/hibachi grill that can be easily interchanged into your classic barbeque grill as well as a multi-purpose stove top all while having friends and family sit around and enjoy your magic. Upon delivery, the My Hibachi BBQ requires no tools for assembly, and is ready to be used right out the box. It is designed to collapse and fit in most standard car trunks. This portability makes it very accessible, allowing you to take the experience right from your backyard all the way to your next tailgate.

## *Outdoor Grilling Innovations L.L.C.*

Toll Free Number: 877-292-7699

Email: [info@myhibachibbq.com](mailto:info@myhibachibbq.com)

Office Address: 8368 N.W. 74th Ave Medley FL, 33166

[www.myhibachibbq.com](http://www.myhibachibbq.com)



2016 Outdoor Grilling Innovations L.L.C.

# Table of Contents

4 What Comes in the Box

5 Assembly

6 Cooking Options

7 Product Features

8 Operating Instructions

9 Cleaning and Maintenance

10 Important Safety Information

11 General Safety Requirements

12 Gas Safety Requirements

13 Liquid Propane Gas Connection

14 LP Gas Connection (Continued)

15 Leak Test

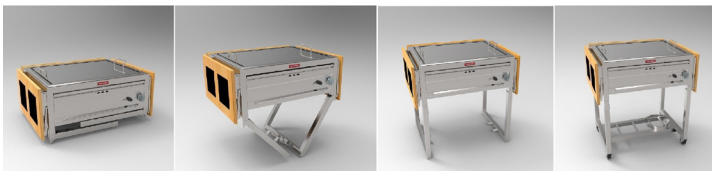

# What Comes in the Box

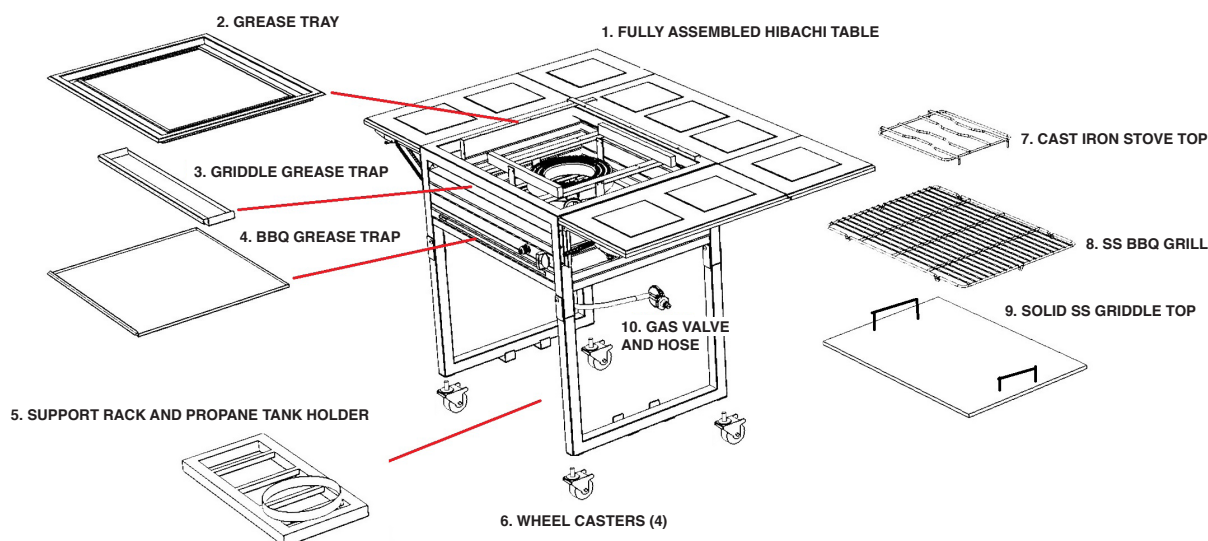

My Hibachi B.B.Q. comes fully assembled. It only requires hand screwing the 4 wheel casters, placing and snapping in the support and LPG tank holder in place.

## In the Box You Will Find:

1. Fully Assembled Unit
2. Grease Tray
3. Griddle Grease Trap
4. BBQ Grease Trap
5. Support Rack and Propane (LPG) tank holder
6. Four wheel casters
7. Cast Iron Stove Top
8. SS BBQ Rack
9. SS Flat Griddle Cooking Plate
10. LPG Gas Valve and Hose.

## Customer Support:

Toll Free: (877) 292-7699 • Email: [info@myhibachibbq.com](mailto:info@myhibachibbq.com)

or visit our web site [www.myhibachibbq.com](http://www.myhibachibbq.com) to view the OUT OF THE BOX video. (step by step video on how to unpack and set up your My Hibachi B.B.Q.)

# Assembly

My Hibachi BBQ comes fully built with minimal assembly required.

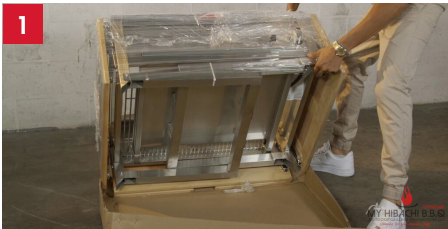

**Step 1:** After removing all parts, tilt unit on its back. Shrink wrap will insure eating tables remain unfolded and undamaged during this process.



**Step 2:** Hand screw 4 castor wheels. Lock each wheel and hand screw all the way to prevent unbalanced unit.



**Step 3:** Place Support Rack. Make sure to place the tank holder facing the right side of the unit so once propane tank is placed it lies directly underneath the gas valve hose.



**Step 4:** Stand Unit (2 adults required). When lifting unit make sure you grab from the stainless steel structural frame NOT the eating tables.



**Step 5:** Remove Classic BBQ Rack. BBQ rack removes from underneath the burner. Remove any remaining shrink wrap.

# Cooking Options



## Hibachi Plate

- Commercial Grade
- 100% 304 Stainless Steel
- Cooking Surface 540 27" x 20"
- 10 MM Thick
- Weight 50 lbs
- Built in Handles

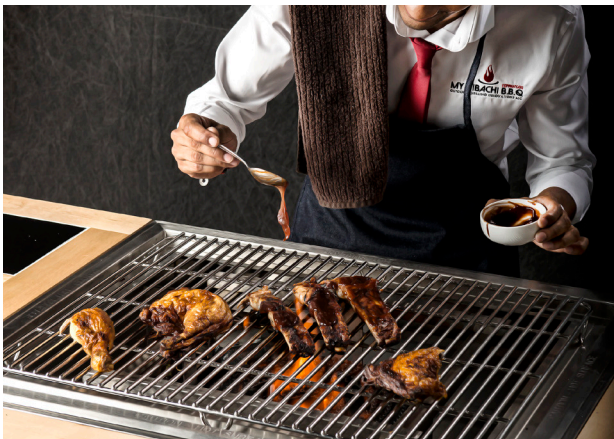

## Classic BBQ Grill

- Commercial Grade
- 304 Stainless Steel
- Cooking Surface 494 26" x 19"



## Stove Top

- Commercial Grade
- Multi-Purpose
- Cast Iron
- 17" x 12"

**NOTE:** *It is very important that you only use one cooking option at a time.*

# Product Features

## Stainless Steel Frame

### (Limited Life-Time Structural Warranty)

Collapsible/foldable 201-18 gauge Stainless Steel frame designed to last. The complete unit can be easily folded by removing the bottom propane tank holder bracket for portability and requires no assembly.

## Eating Tables

Made out of birch wood due to its nature of being weather and heat resistant. While cooking no heat from the burner is transferred because of the birch wood's nature to not retain heat. The ceramic tile plates placed throughout the table keep food warm and can be cleaned easily. Lastly, hinges are placed underneath the tables to allow for easy foldability.

## Dual Cast Iron Burner

### (Limited Life-Time Warranty)

Unlike most standard barbecue grills our Dual Cast Iron Burner is a one-piece mold which ensures no cracks and/or gas leakage. Our commercial grade burner heats up to 40,000 BTU which is guaranteed to heat up your hibachi griddle plate within five minutes and in cold climates. Due to the burner's high heat it also requires little to no cleaning because it burns away any grease or residue that falls onto it while grilling and/or cooking.

## 3 Cooking Tops Included

Hibachi/Teppanyaki solid 304ss plate with 530" sq. inches of cooking area, 10mm thick, solid 304ss traditional barbecue rack and a cast iron multi purpose pot/fryer holder.

## 2 Drip Pans

304 Stainless Steel drip pans that are specifically designed to capture grease and/or residue. The first drip pan can be found above the controls and is intended for grease or residue that is gathered by the teppanyaki/hibachi feature. The second drip pan is found below the burner and covers the entire bottom surface and is intended for any grease and/or residue dispelled from either the multi-purpose stove top or grilling feature.

## Electronic Igniter

Requires one (1) AAA Battery.

## Flame Viewing Window

Three (3) flame viewing windows are placed directly above the controls in order to assure users that the flame is on while cooking on the hibachi/teppanyaki and easily adjust from Low-Med-High.

## Four (4) stools

Portable and foldable stools that can be stored beneath the unit when not in use. Rated up to 300lb.

## Outdoor Water & Weather Proof Cover

Our Heavy Duty and Water Resistant durable outdoor cover is made of a woven polyester fabric with an added UV-stabilized coating and a water-resistant laminated backing.

## Four (4) Cast Iron Wheels

Four (4) Heavy duty cast iron wheels with a built-in brake system. Allows for easy mobility in almost any terrain.

## Standard LPG Gas Valve & Hose Connector

Attached to the unit is a ETL/CSA Gas Valve & Hose Connector.

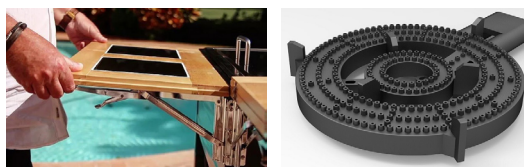

# Operating Instructions

## Eating Tables:

Our eating tables were designed for an easy set up no tools required, all you do is lift and snap. First start by lifting both side eating tables then lift back sider and unfold both corners. Corners should rest on top of both side eating tables to insure support. To close eating tables lift snap and drop.

## Lighting Instructions (Burner)

1. Ensure the Gas Supply Cylinder Valve is closed and the burner knobs are set to the off position.
2. Open the valve on the gas supply cylinder.
3. Press in and rotate the burner knob counterclockwise to the "HI" position. You should here a continuous clicking sound indicating that a spark is being provided to the burner. (If clicking sound is weak, replace battery.)
4. If ignition does not take place within 4 seconds, turn the burner knob to the off position, and wait 5 minutes to repeat lighting procedure.
5. Repeat steps 4-6 to light the second side burner.
6. **CAUTION: Do not leave the My Hibachi B.B.Q. unattended while cooking.**

If the electronic ignition does not light the top burner, the burner can be lit manually using a long match (or taper).

1. Remove or move the Griddle plate to the side so you can see the burner.
2. Ensure the Gas Supply Cylinder Valve is closed and the burner knob is set to the off position.
3. Place a lit match (or taper) over the burner near the igniter.
4. Press in and rotate the burner knob counterclockwise slowly to the "HI" setting. Make sure match (or taper) is lit before turning the knob.
5. If ignition does not take place within 4 seconds, turn the burner knob to the off position, and wait 5 minutes to repeat lighting procedure.
6. **CAUTION: Do not leave the My Hibachi B.B.Q. unattended while cooking.**

## Extinguishing the Burner Flame

1. Depress and rotate burner knob to OFF.
2. Liquid Propane: Close the valve on the gas supply cylinder.



# Cleaning and Maintenance

## General Overview:

Proper care, maintenance, and cleaning will help ensure a long life of your My Hibachi B.B.Q.. Periodic cleaning will help avoid accumulations of flammable grease, fats, and other debris. Some debris and residue may remain on the burner grates and the griddle plate. Please follow the direction below carefully:

**Caution:** *Always allow the unit to cool before cleaning the complete unit. When Cleaning the Griddle Plate it is best to clean when hot as indicated below.*

## Burner Grates:

Wipe up all spill-over as soon as possible after they occur and before they get a chance to burn in and cook solid. The Burner can be cleaned with a brass or stainless steel bristle brush and soapy water. Standard oven cleaner may be used for deeper cleaning. Rinse the Burner thoroughly with clean water before using.

## Griddle Plate:

Rub the surface of a hot griddle with unsalted solid shortening, vegetable oil or spray it with a non-stick cooking spray. Thoroughly wipe it with a rough cloth to remove food particles and other residue. Special griddle cleaners are commercially available which may be used to remove heavy soil build-up. Follow manufacturer's directions exactly. Rinse the griddle with room temperature water after using these cleaners. Dry and coat lightly with cooking oil.

**Caution:** *Using hot soapy water to clean the griddle will remove the cooked-in seasoning and will require re-seasoning by coating lightly with cooking oil.*

The grease tray collects grease, liquid and food particles. It is highly recommended to clean the pan after every use to avoid any possibility of a grease fire. Allow the tray and its contents to cool before cleaning. The grease tray is located in front of the griddle plate assembly. Slightly tilt the grease tray forward and lift the tray to remove it from the griddle plate assembly. Wipe the grease tray clean with a cloth and wash with a hot soapy solution. Make sure the grease tray is fully re-inserted back into your My Hibachi B.B.Q..

## Spider and Insect Warning:

Spiders and other insects can nest in the burners and orifices of this and any other outdoor products, which causes the gas to flow from the front of the burner. This can create a dangerous condition that can cause a fire behind the valve panel, damaging the My Hibachi B.B.Q. and making it unsafe to operate.

Inspect the burner once a year, or if has not been used for more than a month or if any of the following conditions occur:

1. The smell of gas in conjunction with the burner flames appearing yellow.
2. The appliance does not reach temperature.
3. The burner makes popping noises.

# Important Safety Information

**WARNING!** Read this manual carefully and completely before using your appliance to ensure proper operation, proper installation, proper servicing and to reduce the risk of fire, burn hazard and/or other injury.

<p><b>FOR YOUR SAFETY:</b> <b>If you smell gas:</b></p> <ol style="list-style-type: none"><li>1. Shut off gas to the appliance.</li><li>2. Extinguish any open flames.</li><li>3. If odor continues, keep away from the appliance and immediately call your gas supplier or fire department.</li></ol>	<p><b>AVERTISSEMENT:</b> <b>S'il y a une odeur de gaz:</b></p> <ol style="list-style-type: none"><li>1. Coupez l'admission de gaz de l'appareil.</li><li>2. Éteindre toute flamme nue.</li><li>3. Si l'odeur continue, évite l'appareil et appelle tout de suite votre fournisseur de gaz ou les pompiers.</li></ol>
<p><b>FOR YOUR SAFETY:</b></p> <ol style="list-style-type: none"><li>1. Do not store or use gasoline or other flammable vapors and liquids in the vicinity of this or any other appliance.</li><li>2. An LP cylinder not connected for use shall not be stored in the vicinity of this or any other appliance.</li></ol>	<p><b>AVERTISSEMENT:</b></p> <ol style="list-style-type: none"><li>1. Ne pas entreposer ni utiliser de l'essence ni d'autres vapeurs ou liquides inflammables dans le voisinage de l'appareil, ni de tout autre appareil.</li><li>2. Une bouteille de propane qui n'est pas raccordée en vue de son utilisation, ne doit pas être entreposée dans le voisinage de cet appareil ou de tout autre appareil.</li></ol>
<p><b>THIS APPLIANCE IS FOR OUTDOOR USE ONLY:</b> If stored indoors, detach and leave L.P. cylinder outdoors.</p>	<p><b>CE APPAREIL EST POUR UTILISATION À L'EXTÉRIEUR SEULEMENT:</b> Si l'appareil est entreposé à l'intérieur, enlever les bouteilles et les laisser à l'extérieur.</p>
<p><b>BEFORE LIGHTING:</b></p> <ol style="list-style-type: none"><li>1. Read instructions before lighting.</li><li>2. If ignition does not occur in 5 seconds, turn the burner control(s) off, wait 5 minutes, and repeat the lighting procedure.</li></ol>	<p><b>AVANT D'ALLUMER L'APPAREIL</b></p> <ol style="list-style-type: none"><li>1. Lisez les instructions avant d'allumer l'appareil.</li><li>2. Si l'appareil ne s'allume pas en 5 secondes, fermez le robinet du brûleur, attendez 5 minutes, et procédez de nouveau à l'allumage.</li></ol>

# General Safety Requirements

- 1.** The installation of this appliance must conform with local codes or, in the absence of local codes, either the National Fuel Gas Code, ANZI Z223.1/NFPA 54, or CAN/CGA-B149.1, Natural Gas Installation Code or CAN/CGA-B149.2, Propane Installation Code.
- 2.** This outdoor cooking gas appliance is not intended to be installed in or on recreational vehicles and /or boats.
- 3.** This outdoor cooking gas appliance is intended for use outdoors and shall not be used in a building, garage or any other enclosed area.
- 4. Minimum clearance of 12 inches from the back and sides of the appliance to adjacent combustible construction must be maintained. This outdoor cooking gas appliance shall not be located under overhead-unprotected combustible construction.**
- 5.** Keep your appliance in an area clear and free from combustible materials, gasoline and other flammable vapors and liquids.
- 6.** DO NOT obstruct the flow of combustion and ventilation air to this appliance. Keep the ventilation openings of the cylinder enclosure free and clear from debris.
- 7.** Check all gas connections for leaks with soapy water solution and brush. Never use an open flame.
- 8.** Check flexible hoses for cuts and wear that may affect the safety before each use.
- 9.** Never use the unit in a windy area.
- 10.** The pressure regulator and hose assembly supplied with the Gas Unit must be used. Replacement pressure regulators and hose assemblies must be those specified by manufacturer.
- 11. CALIFORNIA PROPOSITION 65-WARNING:** The burning of gas cooking fuel generates some by-products which are on the list of substances known by the State of California to cause cancer or reproductive harm. California law requires businesses to warn customers of potential exposure to such substances. To minimize exposure to these substances always operate this unit according to the use and care manual, ensuring you provide good ventilation when cooking with gas.

*In Massachusetts: All gas products must be installed using a "Massachusetts" licensed plumber or gasfitter. A "T" handle type manual gas valve must be installed in the gas supply line to this appliance. This applies to permanently installed natural gas and propane installations. This does not apply to propane portable installations using a 20 pound tank.*

# Gas Safety Requirements

Each appliance is set and tested at the factory for the type of gas supply to be used. The My Hibachi B.B.Q. is a LPG/PROPANE GAS UNIT and is not designed to be converted to NG/ Natural GAS. IT IS AN OUTDOOR LPG / PROPANE GAS UNIT.

All gas connections should be made by a qualified technician and in accordance with local codes and ordinances. The installation must conform with local codes or, in the absence of local codes, with either the national Fuel Gas Code, ANSI Z223.1/NFPA 54, or CAN/CGA-B149.1, Natural Gas Installation Code or CAN/CGA-B149.2, Propane Installation Code.

## **WARNING:**

**CHECK TO ENSURE THAT THE GAS SUPPLY HOSE DOES NOT COME IN CONTACT WITH ANY HOT SURFACE OF THE APPLIANCE.**

**NEVER CONNECT THE APPLIANCE TO AN UNREGULATED GAS SUPPLY.**

## **L.P. GAS (LIQUIFIED PETROLEUM /PROPANE)**

If your appliance is factory built for L.P., the regulator supplied is set for 11" water column and is for use with L.P. gas only. The factory-supplied regulator and hose must be used with a 20 lb. L.P. cylinder.

## **L.P. GAS SAFETY REQUIREMENT**

The LP-gas supply cylinder must be constructed and marked in accordance with the *Specifications for LP-gas Cylinders* of the U.S. Department of Transportation (D.O.T.) or the National Standards of Canada *CAN/CSA-B339, Cylinders, Spheres and Tubes for the Transportation of Dangerous Goods, and Commission*, as applicable; and

1. Provided with a listed overfilling prevention device.
0. Provided with a cylinder connection device compatible with the connection for outdoor cooking appliances.

It must be provided with a shut-off valve terminating in gas tank valve outlet. It must include a collar to protect the cylinder valve. The cylinder supply system must be arranged for vapor withdrawal.

Do not operate the My Hibachi B.B.Q. indoors or in any enclosed area. If My Hibachi B.B.Q. is not in use, the gas must be turned off at the supply cylinder. If the My Hibachi B.B.Q. is to be stored indoors, disconnect the gas supply cylinder and leave the cylinder outdoors.

# Liquid Propane Gas Connection

## **WARNING:**

*The gas supply hose should be inspected prior to each use. Do not use a gas hose that has abrasions, cuts, or excessive wear.*

*The gas supply must be turned off at the LP Gas supply cylinder and the LP Gas supply cylinder must be disconnected from the regulator when this outdoor cooking gas appliance is not in use.*

*When stored indoors, remove and store the LP Gas cylinder outdoors in a protected, cool, and dry location out of reach of children. The cylinder should not be stored in a building, garage, or any other enclosed area.*

## **CAUTION:**

Store the cylinder in an upright position so that the cylinder valve is at the top. This will ensure proper vapor withdrawal.

The cylinder used must include a collar to protect the cylinder valve.

Store any spare or extra gas cylinder(s) in a cool, well ventilated outdoor location at least 15 feet from the My Hibachi B.B.Q. and other open flame, heat-producing appliance(s) or heat source.

**NOTE:** An enclosure for a propane gas cylinder shall be vented by openings on the level of the cylinder valve and at floor level. The effectiveness of the opening(s) for purposes of ventilation shall be determined with the propane gas supply cylinder in place. This shall be accomplished by one of the following:

- a.** One side of the enclosure shall be completely open; or,
- b.** For an enclosure having four sides, a top and a bottom:
  - At least two ventilation openings at cylinder valve level shall be provided in the sidewall, equally sized, spaced at 180 degrees (3.14 rad), and unobstructed. Each opening shall have a total free area of not less than 1/2 square inch per pound (7.1 cm<sup>2</sup>/kg) of stored fuel capacity and not less than a total free area of 10 square inches (64 cm<sup>2</sup>).
  - Ventilation opening(s) shall be provided at floor level and shall have total free area of not less than 1/2 square inch per pound (7.1 cm<sup>2</sup>/kg) of stored fuel capacity and not less than a total free area of 10 square inches (64.5 cm<sup>2</sup>). If ventilation openings shall be at floor level and are in a sidewall, there shall be at least two openings. The bottom of the openings shall be at floor level and the upper edge no more than 5 inches (127 mm) above the floor. The openings shall be equally sized, spaced at 180 degrees (3.14 rad) and unobstructed.
- c.** Every opening shall have minimum dimensions so as to permit the entrance of 1/8 inch (3.2 mm) diameter rod.

# LP Gas Connection (Continued)

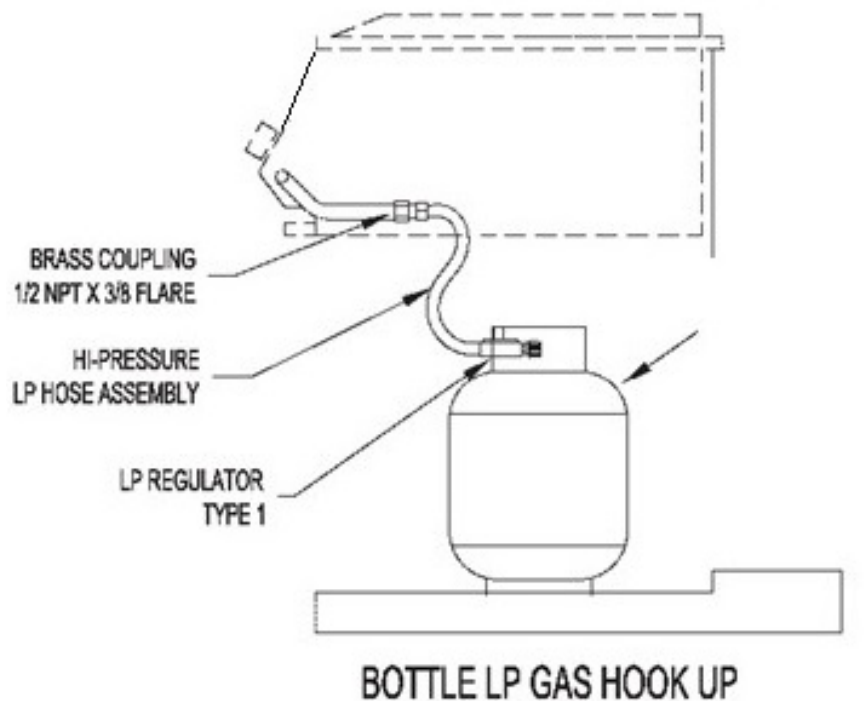

**CAUTION:** Provide adequate ventilation holes in the enclosure for safety purposes in the event of gas leak

## Procedure for LP Gas Cylinder Connection (20 lbs)

- 1.** Turn Hand Wheel on cylinder clockwise until it stops to ensure the Cylinder Valve is fully closed.
- 2.** Turn all of the burner knobs to the OFF position. Connect the 3/8" Flare end of the hose to the 3/8" Flare end of the brass coupling on the unit using a 3/4" open wrench. Do not apply pipe sealant.
- 3.** Connect the regulator to the LP cylinder. Do not use any tools. Hand-tighten the regulator.
- 4.** Check for leaks using a soapy water solution.
- 5.** See figure above for a typical LP gas hook up.
- 6.** To disconnect after use, turn the burner knob to the OFF position. Close the Cylinder Valve by turning the Hand Wheel counter-clockwise until it stops.
- 7.** Disconnect the regulator from the LP cylinder after use.

# Leak Test

## CAUTION BEFORE TESTING:

- NEVER USE THE UNIT WITHOUT FIRST LEAK TESTING THE GAS CONNECTIONS.
- WARNING: DO NOT USE OPEN FLAME TO CHECK FOR LEAKS. USE OF AN OPEN FLAME COULD RESULT IN A FIRE, EXPLOSION AND BODILY HARM.
- DO NOT SMOKE WHILE PERFORMING THE LEAK TEST!
- To prevent fire or explosion hazard, DO NOT use or permit sources of ignition in the area while performing a leak test. Perform leak test outdoors only.
- Check to ensure that flexible hoses do not have any cuts and wear that may affect the safety before each use. Only the factory supplied hose and regulator must be used. Use only replacement regulator and hose assemblies specified by manufacturer.

## LEAK TEST:

- 1.** Prepare a leak testing solution of sudsy water by mixing in a spray bottle with half liquid soap and half water.
- 2.** Confirm that all control knobs are in the OFF position.
- 3.** Turn the main gas valve supply ON.
- 4.** Apply leak testing solution by spraying on the pipe joints, fittings, and hose. (See diagram below)
- 5.** A gas leak is detected if;
  - a.** there is a faint gas smell and/or...
  - b.** ...growing bubbles appear on any of the connection points and/or hose. DO NOT attempt to ignite the appliance and IMMEDIATELY turn off the gas supply valve.
- 6.** When there is a gas leak, call a qualified service technician. DO NOT use the appliance until the leak is corrected.

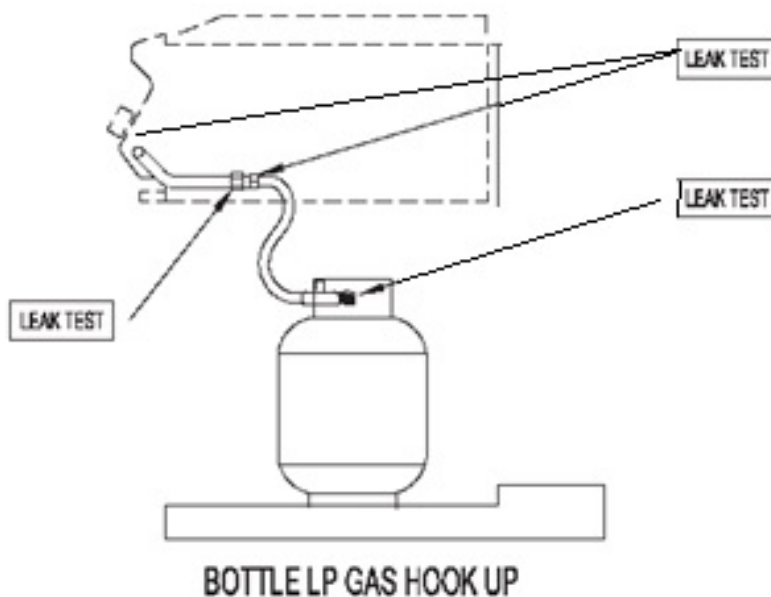



TEPPANYAKI  
**MY HIBACHI B.B.Q.**  
OUTDOOR GRILLING INNOVATIONS LLC  
*Changing The Way America Grills*

Thank you for purchasing My Hibachi B.B.Q! We hope you enjoy your new grill. Thank you for your support in your purchase with us!

*- My Hibachi B.B.Q Team*