

Assembly Instructions

Caution: You must read this before you proceed

ADIRONDACK

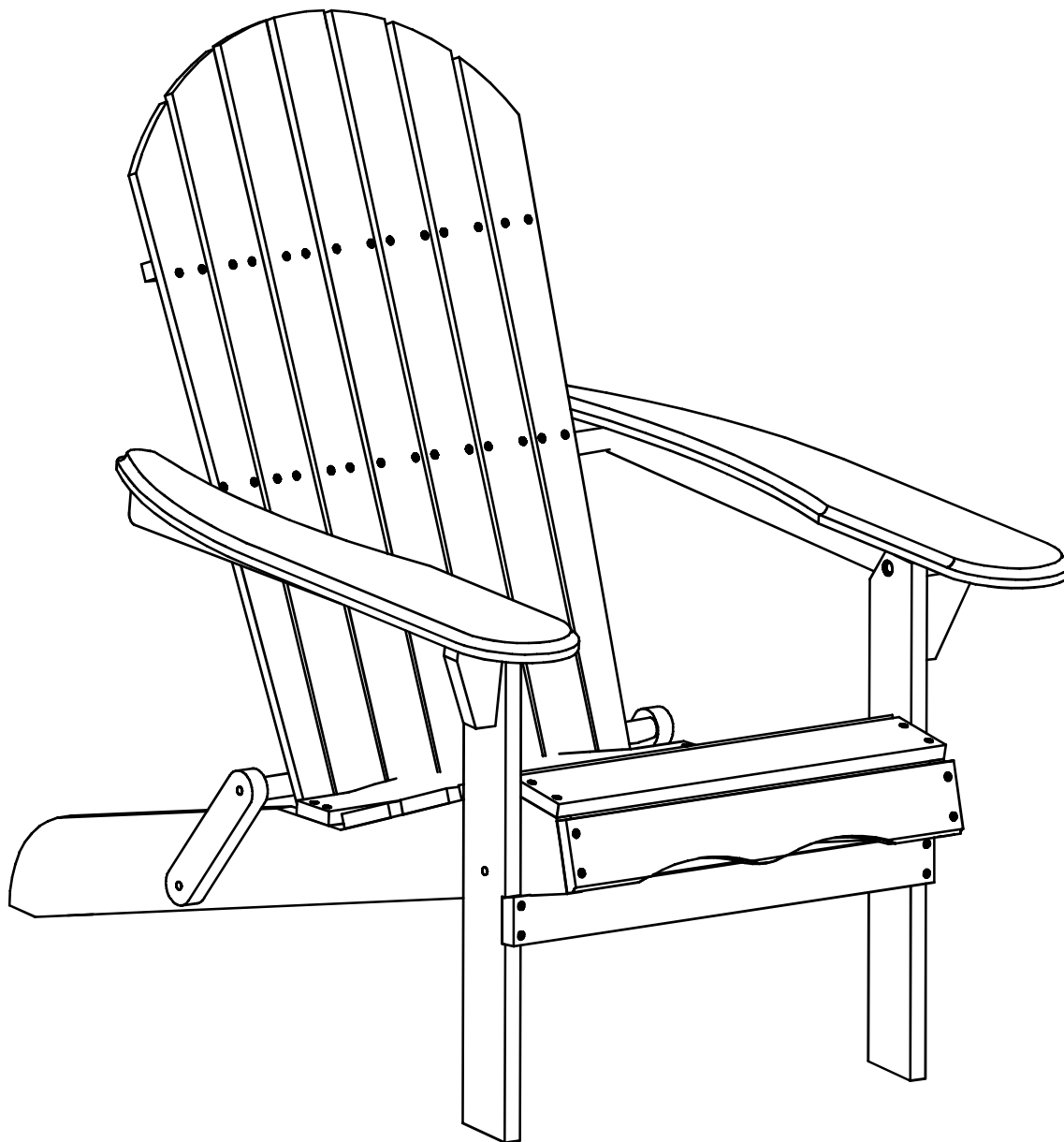





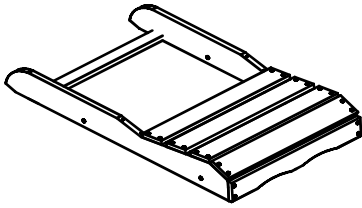
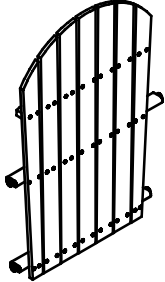
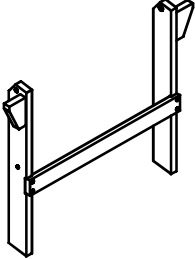
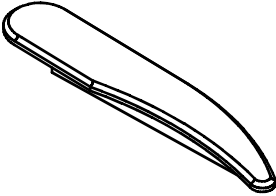
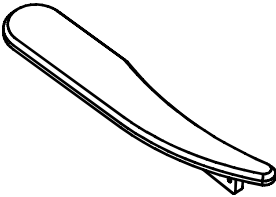
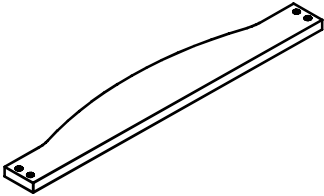
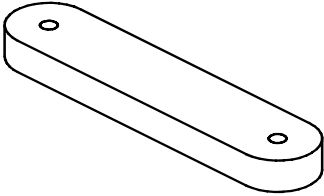

CAUTION : This Adirondack is NOT a TOY.
Keep your child / children at bay during the assembly process.
For moving the Adirondack and to prevent damage to the Adirondack, two adults are needed to execute this action.

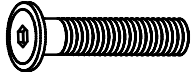
Parts List

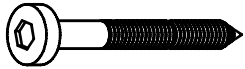
Label	Picture	Description	QTY
A		Seat Panel	1
B		Backrest	1
C		Pre-fixed Front Leg	1
D		Left Armrest	1
E		Right Armrest	1
F		KD Slat	1
G		Folding Support Bar	2



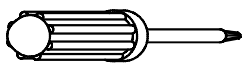

Parts List

Label	Picture	Description	QTY
①		Bolt (M8x35)	7
②		Sleeve Nut (M8x15)	7
③		Long Screw (M7x70)	3
④		Short Screw (M7x40)	3
⑤		Screw (M4x30mm) (Use with Screwdriver)	5
⑥		Plastic Washer	7
⑦		Allen Key	2
⑧		Screwdriver	Not provided

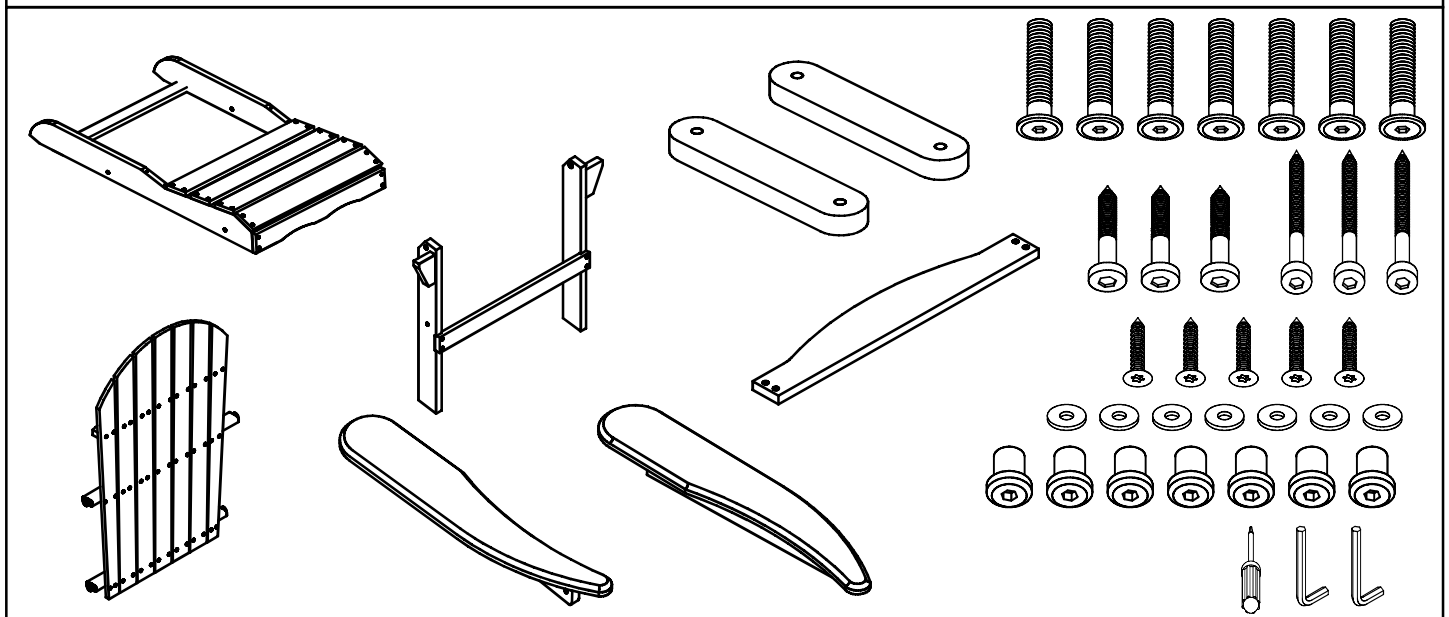
Assembly Preparation

Before Beginning Assembly:



-  • Read instructions, cover to cover-
-  • Have 2 adults on hand for assembly-
-  • Do not assemble on flooring or carpet-
-  • Assemble on a clean non-marring surface (packing foam)-
-  • Save all packaging until finished-

Assembly Steps

OVERVIEW

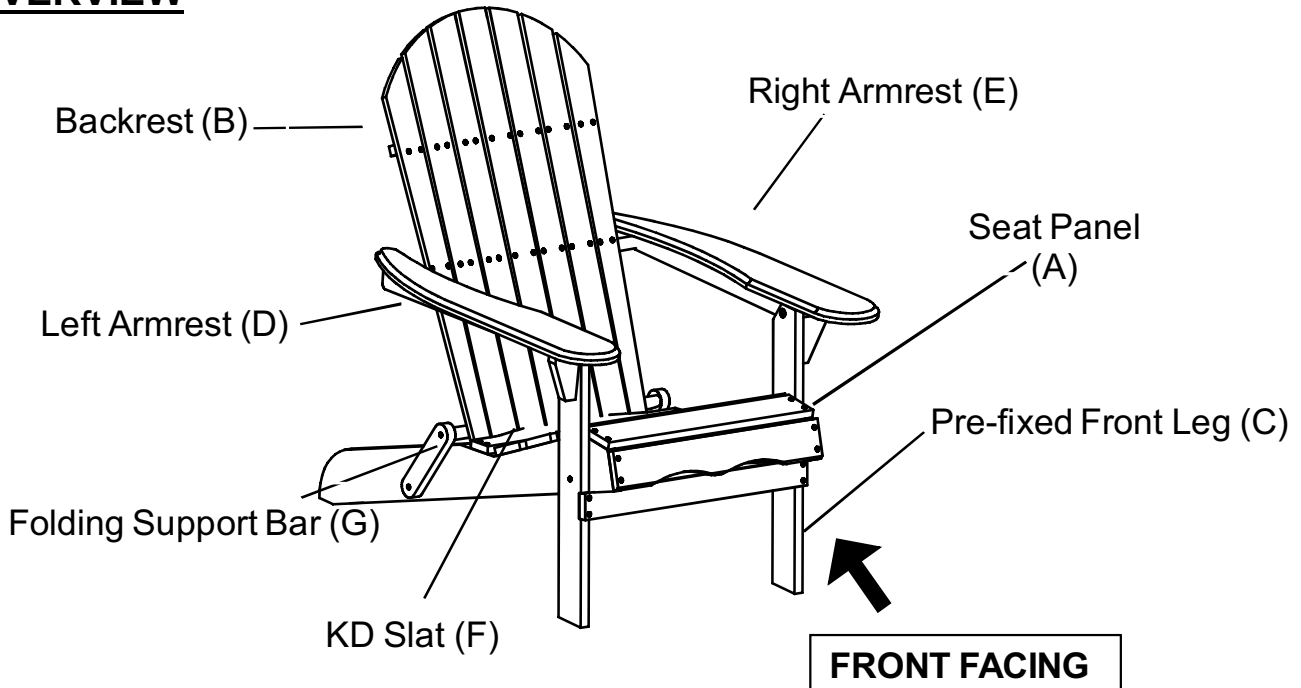

This Adirondack has multiple parts and may require up to 30 minutes to assemble. To give you an overview of the Adirondack parts, the above picture is to help you put the various parts into perspective. Please read through the instructions below to familiarise yourself with the parts and steps before assembly.

Step 1

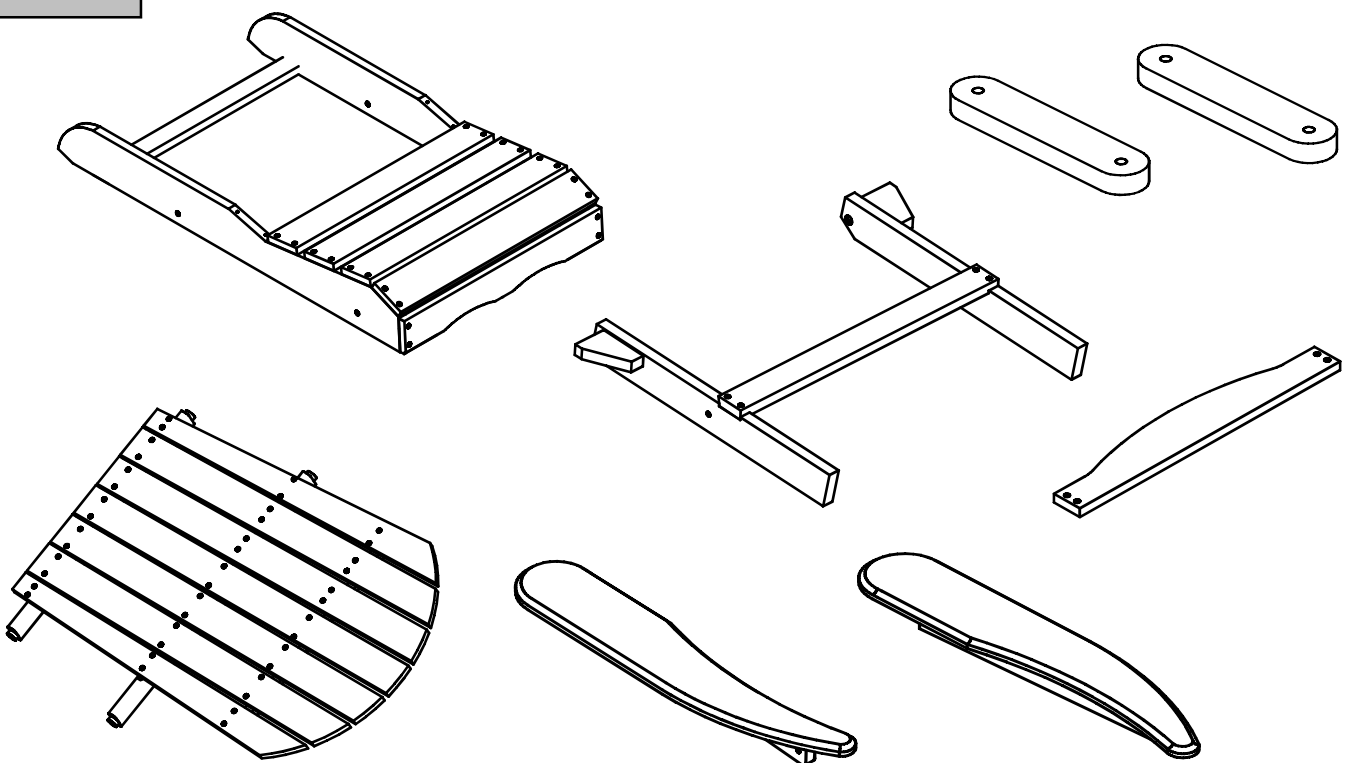

Unpack and place all parts on a clean, non-marring surface.

Step 2

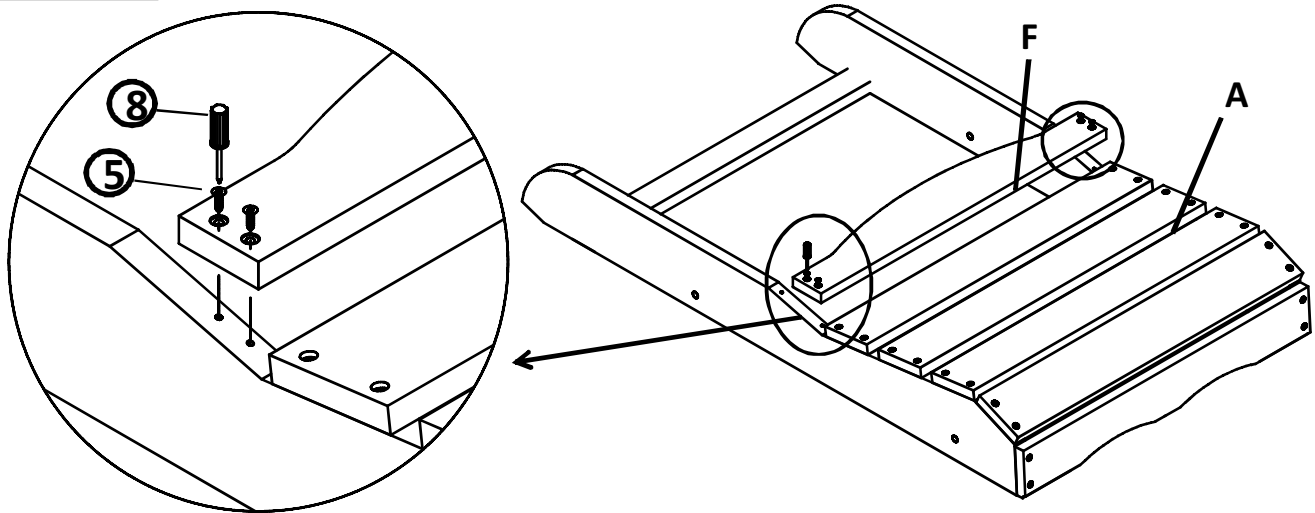

Place the Seat Panel(A) onto a clean, non-marring surface.
Position KD Slat(F) onto the Seat Panel(A) and attach using 4 Screws(5) and Screwdriver(8)

Step 3

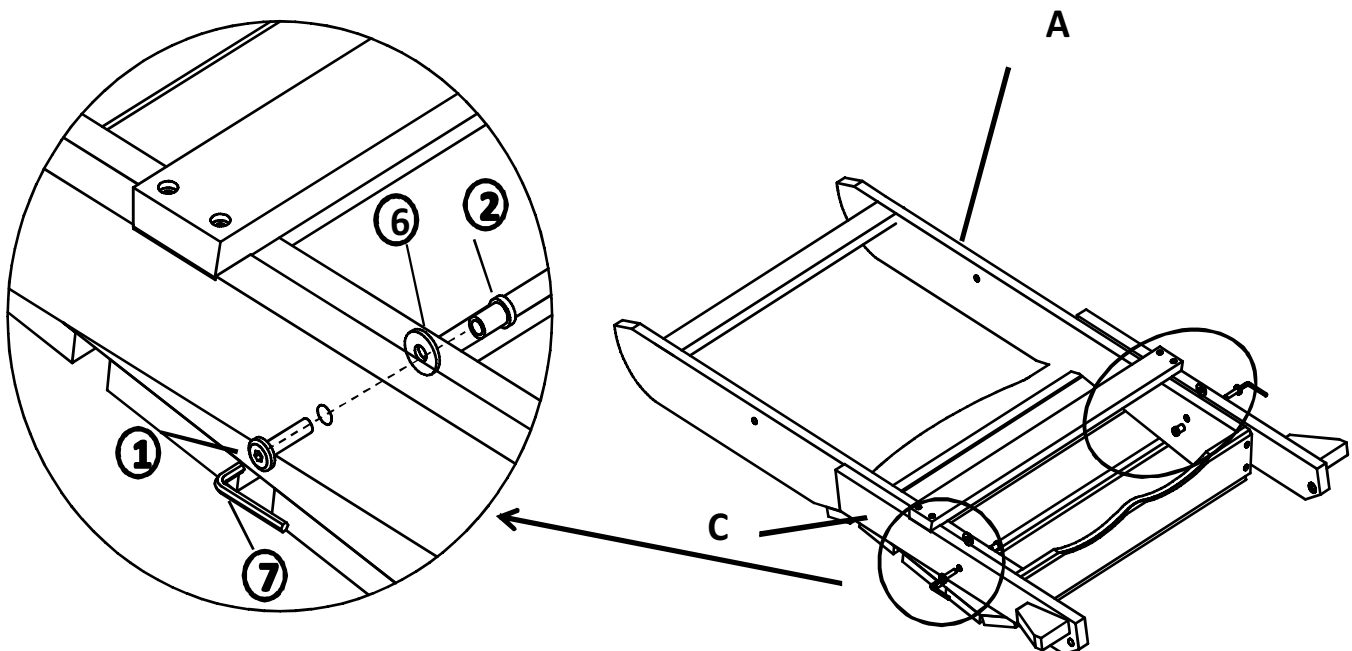

Place the Seat Panel(A) as shown in the picture.
Attach Pre-fixed Front Leg(C) to Seat Panel(A) using Bolts(1), Plastic Washers(6), and Sleeve Nuts(2) with Allen Keys(7)
Do not fully tighten Bolts
Note: The Plastic Washer should be placed between the Seat Panel and Pre-fixed Front Leg.

Step 4

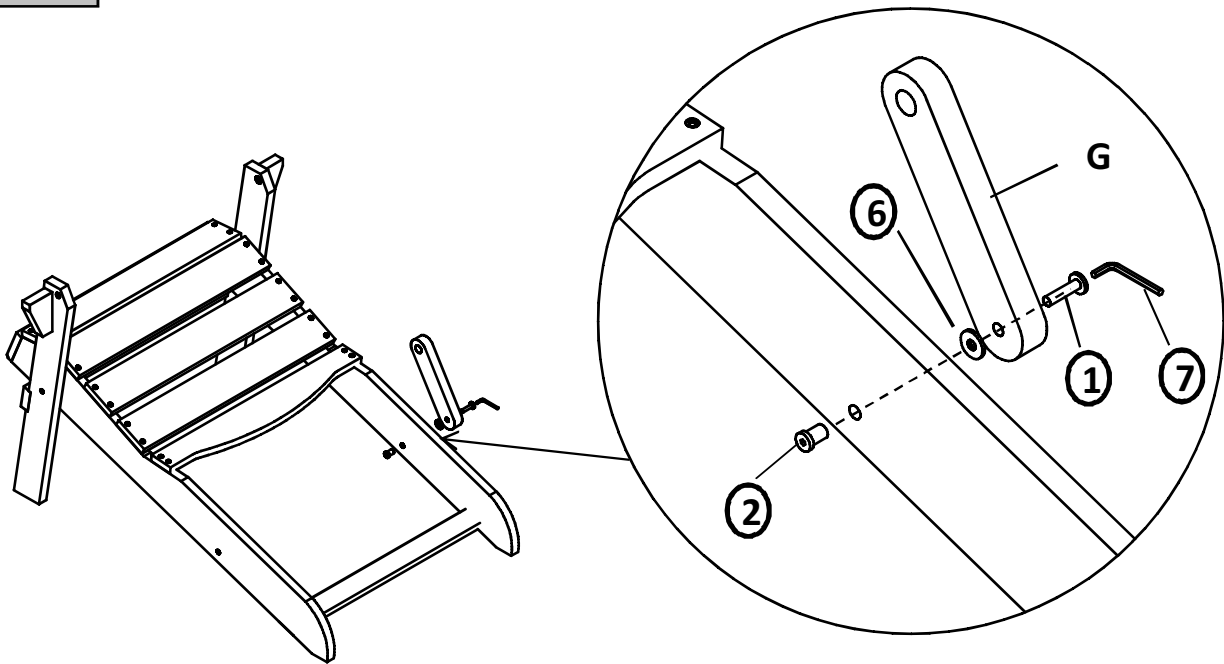

Place the Frame in Step 3 in the position as picture above
Attach Folding Support Bar(G) to Seat Panel(A) using Bolt(①), Plastic Washer(⑥), and Sleeve Nut(②) with Allen Keys(⑦).

Do not fully tighten Bolts.

Note: Plastic Washer should be placed between Seat Panel and Folding Support Bar.

Step 5

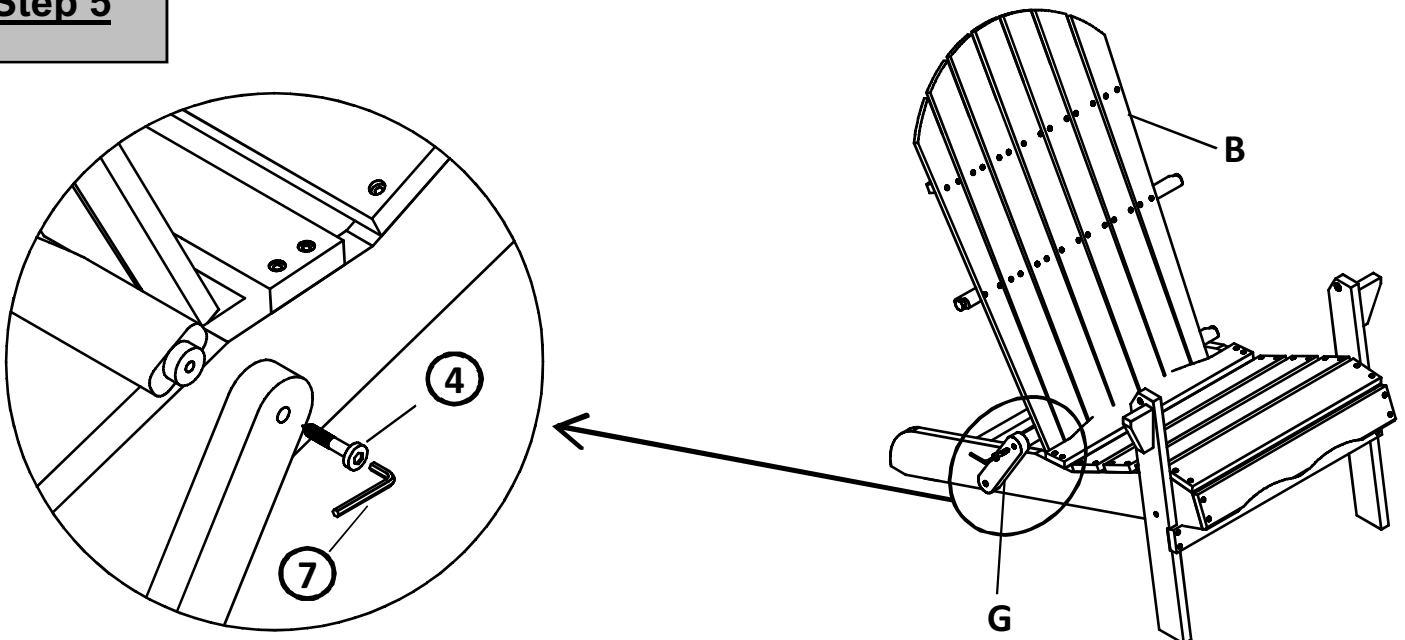

Position Backrest (B) with mortise into housing of Folding Support Bar (G)
Secure Folding Support Bar(G) to Backrest(B) using Short Screw(④) with Allen Key(⑦).

Do not fully tighten Screws

Repeat the same process with the second Folding Support Bar(G).

Step 6

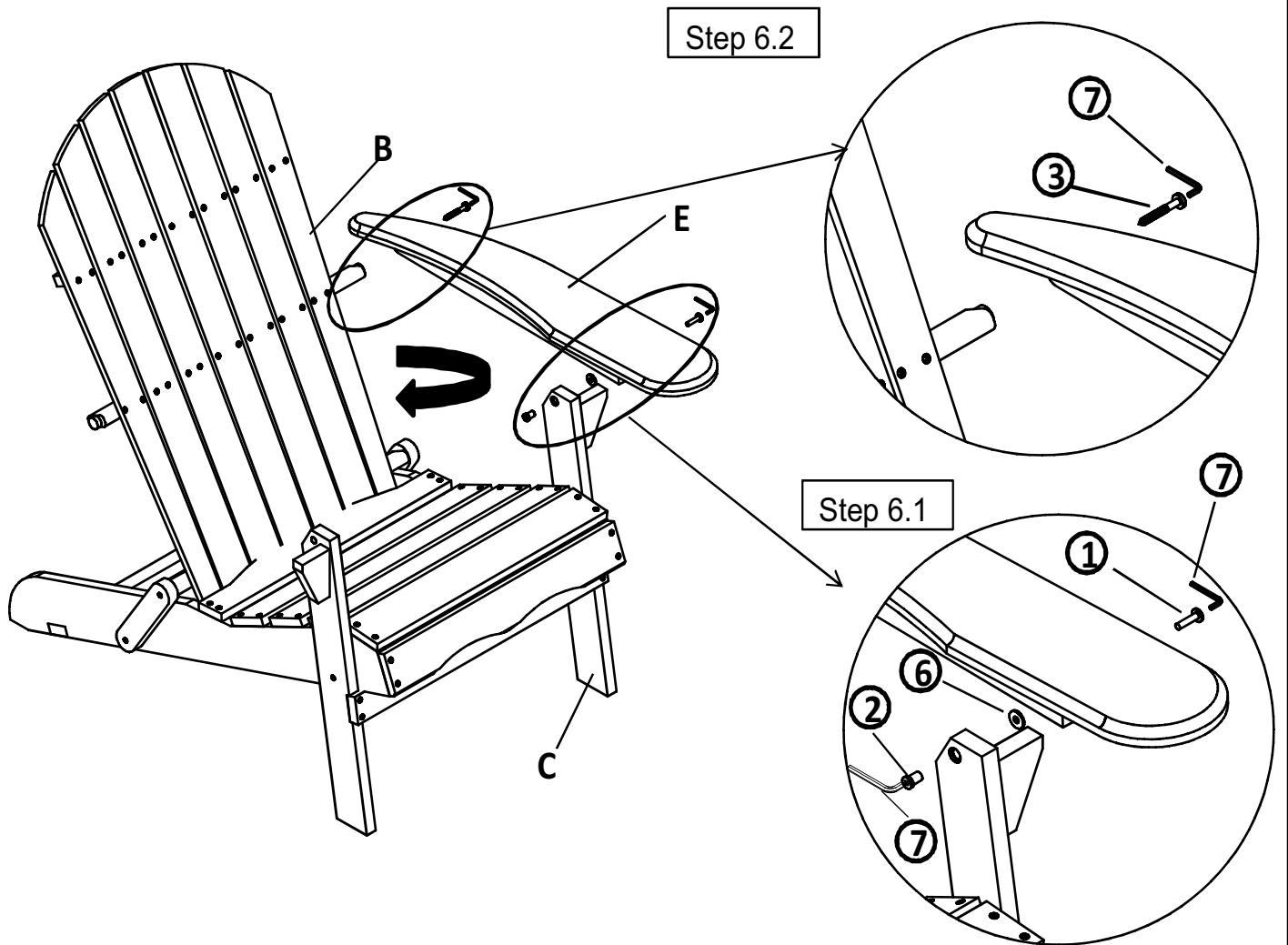

Open Backrest(B) as indicated with the arrow.

6.1) Secure Left Armrest(D) to Pre-fixed Front Leg(C) by using Bolt(①), Plastic Washer(⑥), and Sleeve Nut(②) with Allen Keys(⑦).

6.2) Secure Left Armrest(D) to Backrest(B) using Long Screw(③) with Allen Key(⑦).

Do not fully tighten Bolts and Screws.

Note: Plastic Washer should be placed between Left Armrest and Pre-fixed Front Leg.

Repeat the same process with the Right Armrest(E).

In a sequential manner, tighten all Bolts and Screws at all joints until fully locked into position.

Step 7

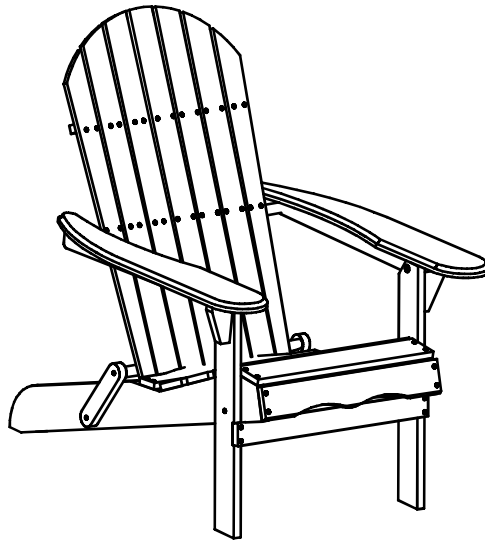

Your Adirondack is ready for use.

This Adirondack can only be used on a flat, level surface.

Step 8

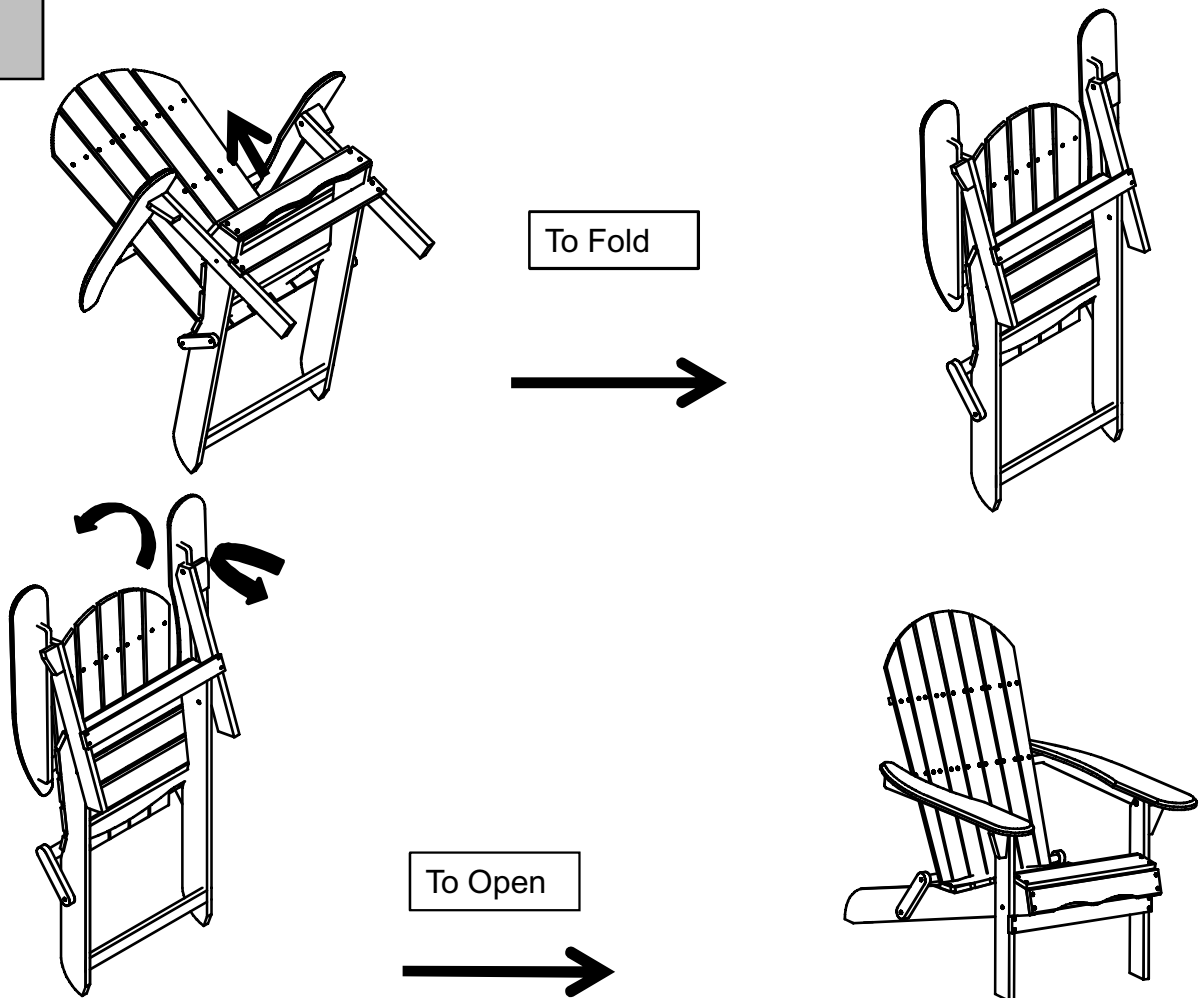



















This Adirondack can be folded shut.

To fold this Adirondack, raise up Backrest and fold Seat with Leg Frame as indicated by the arrows, by hand, until the Adirondack folds shut

To open this Adirondack, open Backrest and Seat as indicated by the arrows, by hand until the Adirondack folds out and locks into position.

Note: This Adirondack is slightly heavy, do exercise caution to avoid injury.

Care & Maintenance

-   ● Do not put hot items directly on furniture surface.
 -   ● Do not clean furniture with harsh cleansers or polish.
 -   ● To obtain the longest lifespan of your outdoor products, minimizing exposure to direct sunlight is recommended.
 -   ● Children should not climb or jump on the furniture.
 -   ● Do not write on furniture without a padded barrier to protect the surface.
 -   ● To obtain the longest lifespan of your outdoor products, avoid extended and lengthy exposure to rain, snow, and direct sunshine. Whenever possible cover the product and /or place under patio or awnings.
 -   ● Not for commercial use. For residential use only.
 -   ● Stains may be removed with mild soap solution and damp cloth.
-
-   ● Dust and pick-up spills using a clean, non-colored, lint-free cloth.

Questions & Answers about Proposition 65

- **What is Proposition 65?**

Proposition 65 requires businesses to provide warnings to Californians about significant exposures to chemicals that cause cancer, birth defects or other reproductive harm. These chemicals can be in the products that Californians purchase, in their homes or workplaces, or that are released into the environment. By requiring that this information be provided, Proposition 65 enables Californians to make informed decisions about their exposures to these chemicals.

Proposition 65 also prohibits California businesses from knowingly discharging significant amounts of listed chemicals into sources of drinking water.

Proposition 65 requires California to publish a list of chemicals known to cause cancer, birth defects or other reproductive harm. This list, which must be updated at least once a year, has grown to include approximately 900 chemicals since it was first published in 1987.

- **What types of chemicals are on the Proposition 65 list?**

The list contains a wide range of naturally occurring and synthetic chemicals that include additives or ingredients in pesticides, common household products, food, drugs, dyes, or solvents. Listed chemicals may also be used in manufacturing and construction, or they may be byproducts of chemical processes, such as motor vehicle exhaust.

- **What does a warning mean?**

If a warning is placed on a product label or posted or distributed at a workplace, a business, or in rental housing, the business issuing the warning is aware or believes that it is exposing individuals to one or more listed chemicals.

By law, a warning must be given for listed chemicals unless the exposure is low enough to pose no significant risk of cancer or is significantly below levels observed to cause birth defects or other reproductive harm.

- **Where can I get more information on Proposition 65?**

If you have specific questions on the administration or implementation of Proposition 65, you can contact OEHHA's Proposition 65 program at P65.Questions@oehha.ca.gov, or by phone at (916) 445-6900.