

Home Decorators

-Collection-











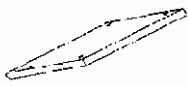

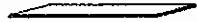

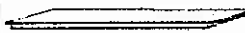

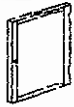

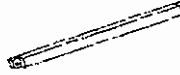



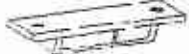

BF-21014 Hampton Bay 4 Door Cabinet wide

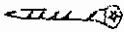
ASSEMBLY INSTRUCTOINS

Made In China

Thank you for purchasing this quality product. Be sure to check all packing material carefully for small parts. Which may have come loose inside the carton during shipment separate identity. And count all parts and metal hardware compare with parts list to be sure all parts are present. If any parts are missing or damaged, phone, fax, or mail to our customer service department for efficient and speedy service please indicate the model number and code letter of part(s) need.

IMPORTANT NOTE: Follow instructions listed below in proper sequence as numbered to assure fast, easy and correct assembly.

PARTS LIST				
A  BOTTOM PANEL-1PC	B  FEET-4PCS	C  LEFT SIDE PANEL-1PC	D  RIGHT SIDE PANEL-1PC	E  ACROSS PANEL-1PC
F  TOP PANEL 1PC	G  LEFT DOOR 1PC	H  RIGHT DOOR-1PC	I  LEFT DOOR 1PC	J  RIGHT DOOR1 1PC
K  JOIN PANEL-1PC	L  BACK PANBL-2PCS	M  SHELF-2PCS	N  CAM-BOLTS-12PCS	O  CAM-LOCKS-12PCS
P  SCREWS-3PCS	Q  LARGE MAGNET-2PCS	R  SCREWS-34PCS	S  SCREWS-52PCS	T  HINGES-8PCS
U  FEMALE MAGNET-4PCS	W  SCREWS-4PCS	V  HANDLE 4PCS	X  SHELF SUPPORTS-8PCS	Y  SCREWS-4PCS
Z  CAM-TOOL-1PC	A1  SCREW-TOOL-1PC			

NOTE: Upon opening thoroughly clean all wood surfaces with furniture polish to remove dust and dirt that may have settled onto finish during shipment. In order to protecting the product. Please assemble the product with at least two people.

1.) Assemble the Bottom (A) and Feet (B).

Through the holes of the feet(B)use Screw-tool (A1) to rotate Screws (Y) into the holes of the Bottom panel (A). (See below picture)

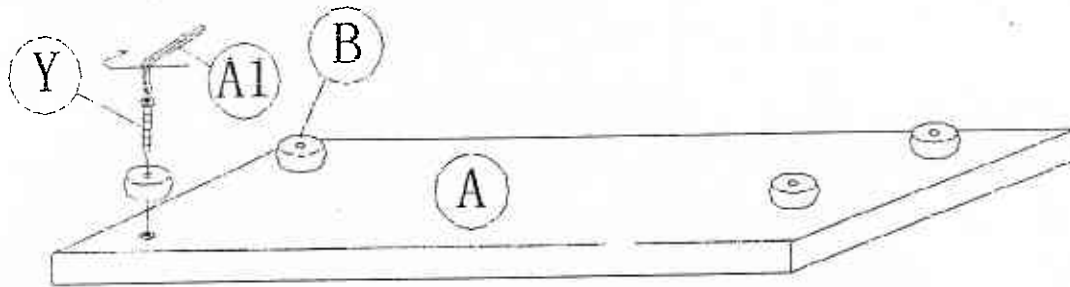

2.) Assemble the Left/right side panel (C, D) and across panel (E).

Use Cam-tool (Z) to tighten Cam-bolts (N) into the holes of the left/right side panel(C/D) and across panel (E). Use Cam-tool (Z) to tighten Cam-locks (O) into the large hole of the across panel (E).(See below picture)

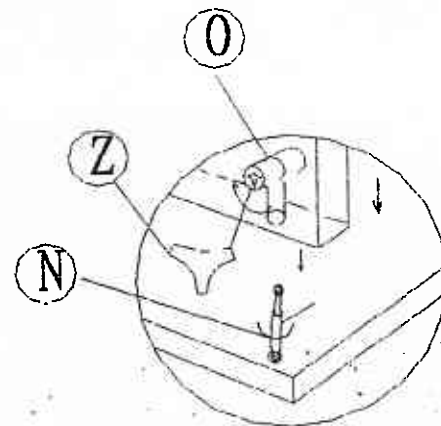
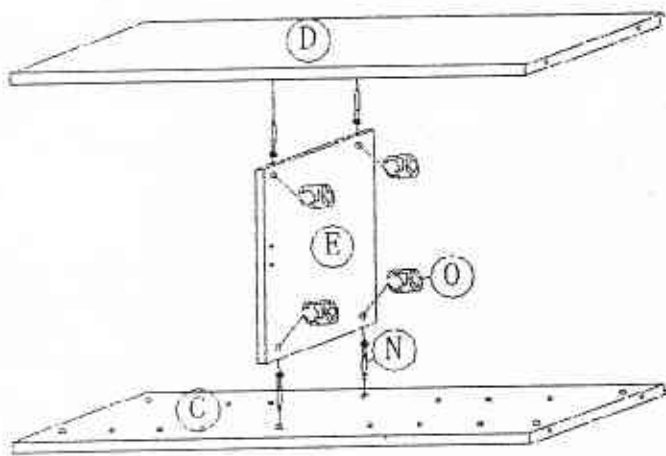

3.) Assemble Top panel(F) and Bottom panel (A).

Use Cam-tool (Z) to tighten Cam-bolts (N) into Top panel (F) and bottom panel (A) and left/right side panel(C/D) Use Cam-tool(Z) to tighten Cam-locks (O) clockwise into the large holes of Left/right side panel (C, D). (See right picture)

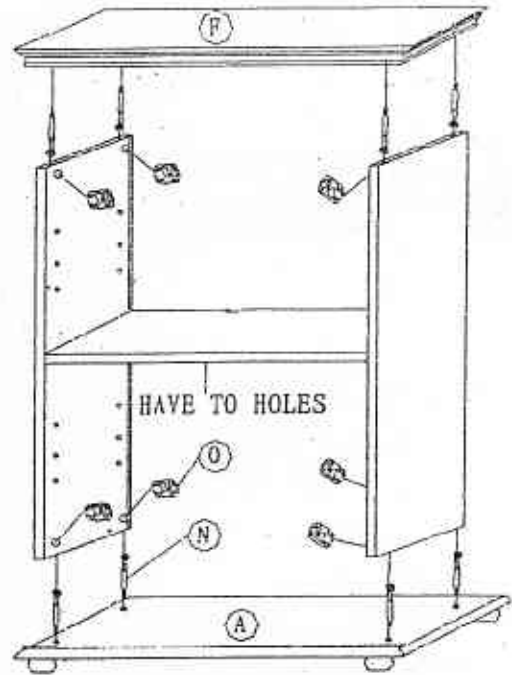

4.) Assemble the Left/right Door (G/I/H.J) and Female magnet (U), Handles (V) and Large magnet(Q)

Through the hole of Female magnet (U) rotate Screws (S) into the hole of the Left/right Doors (G,I/H.J). Through the holes Hinges (T) rotate Screws (S) into the hole of the Left/right doors (G,I/H.J) and Left/right Side panel (C, D) Through the holes large magnet(Q) to rotate screws(R) into the top panel(A) and the across panel(E). Through the holes of the left/right door(G,I/H.J) to rotate screws(W) into handle(V). (See below picture)

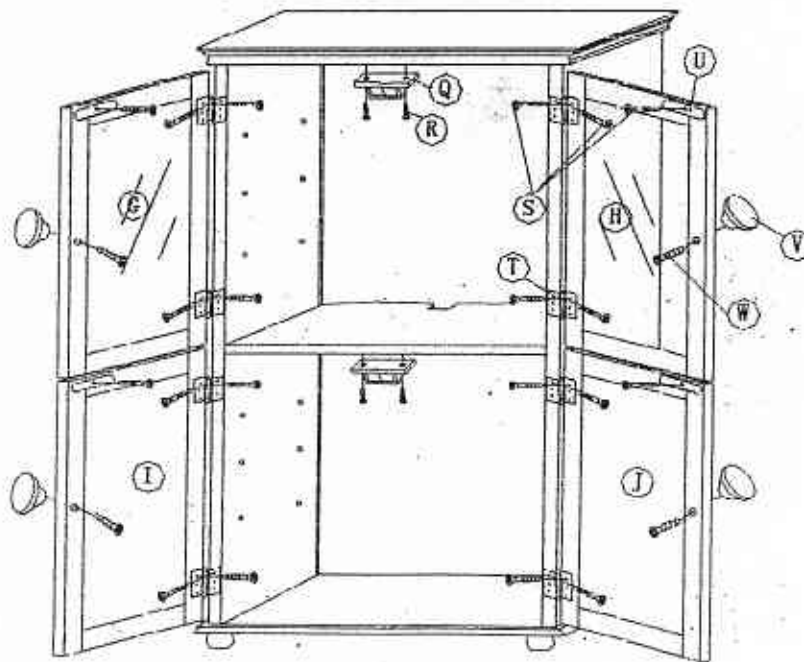

5.) Assemble the back panel(L)and shelf(M)

Attach join panel(K)to top panel(F)and bottom panel(A)and across panel(E).follow attach back panel(L)to the top/bottom panel(F/A)and left/right panel(C/D)and the across panel(E)using Screws (R/P) Insert Shelf supports (X) into the holes of Left/right side panel (C, D) then put shelf (M)on the shelf supports(X).(See below picture)

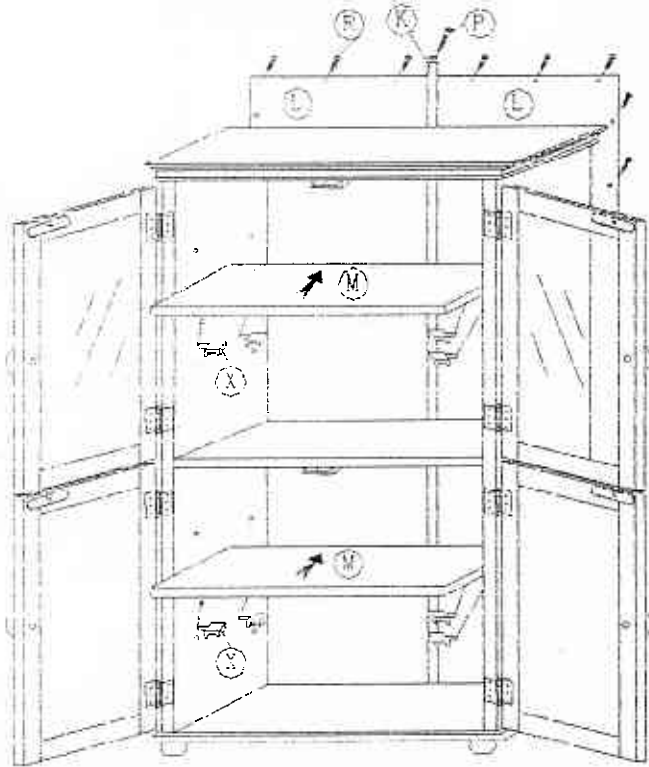

OK! (See right picture)

