

1-1/4" Schedule 40 PVC Pipe

SPECIFICATIONS
Product SKU: P114FGP

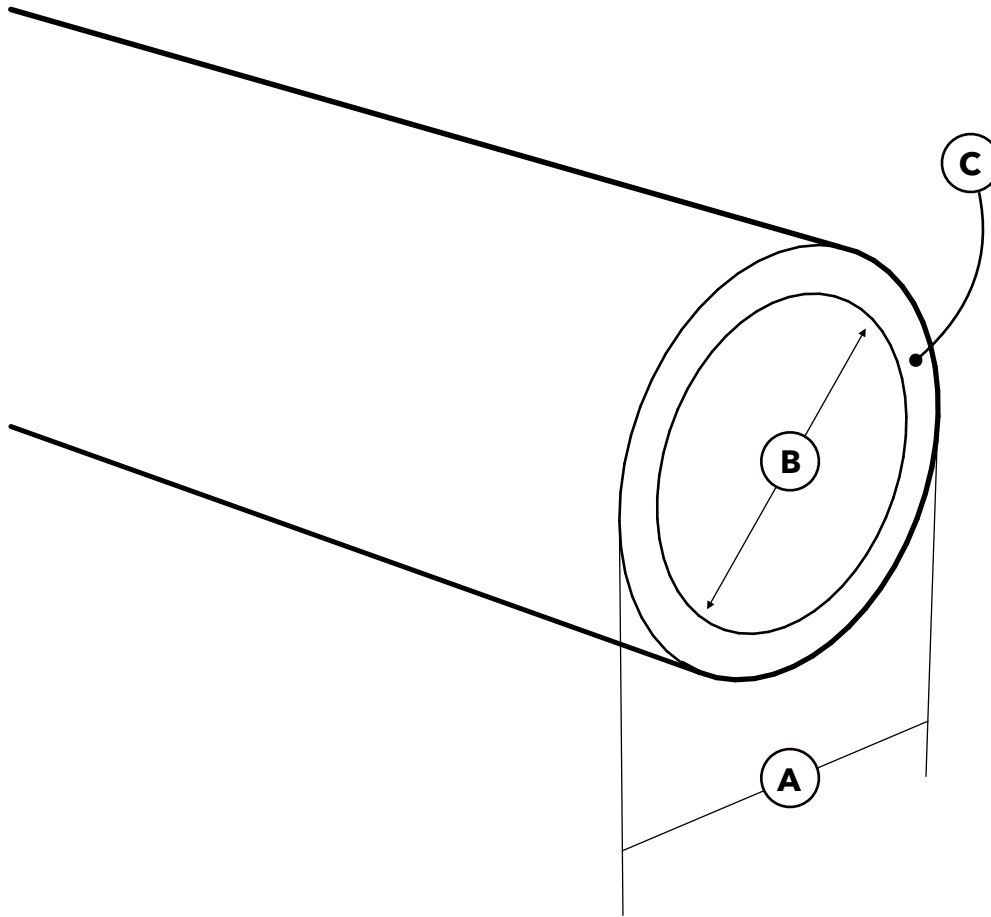

ID	Description	Dimension
A	Outside Diameter	1.660 in.
B	Avg. Inside Dia.	1.380 in.
C	Min. Wall Thickness	0.140 in.
	Weight	0.450 lb./ft.
	Schedule	40

NOTICE: All information within this Technical Specifications document is accurate at the time of document date. Product specifications and/or appearance may change.

