

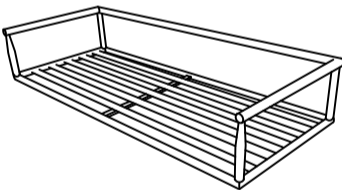

	PARTS LIST	DESCRIPTION	QTY
A		CHAIR FRAME	1
B		LEG	4
C		MIDDLE LEG	1
D		1/4"x16 mm BOLT	18
E		Ø6.5x1.0 mm WASHER	18
F		HEX BOLT DRIVER	1

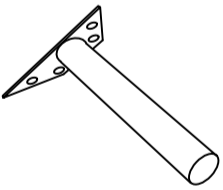

	PARTS LIST	DESCRIPTION	QTY
A		TABLE TOP	1
B		TABLE LEG	3
C		1/4"x16 mm BOLT	12
D		Ø6.5x1.0 mm WASHER	12
E		HEX BOLT DRIVER	1

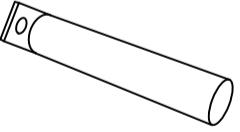
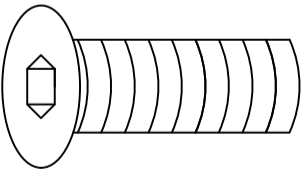
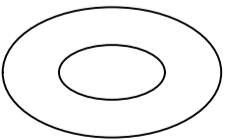

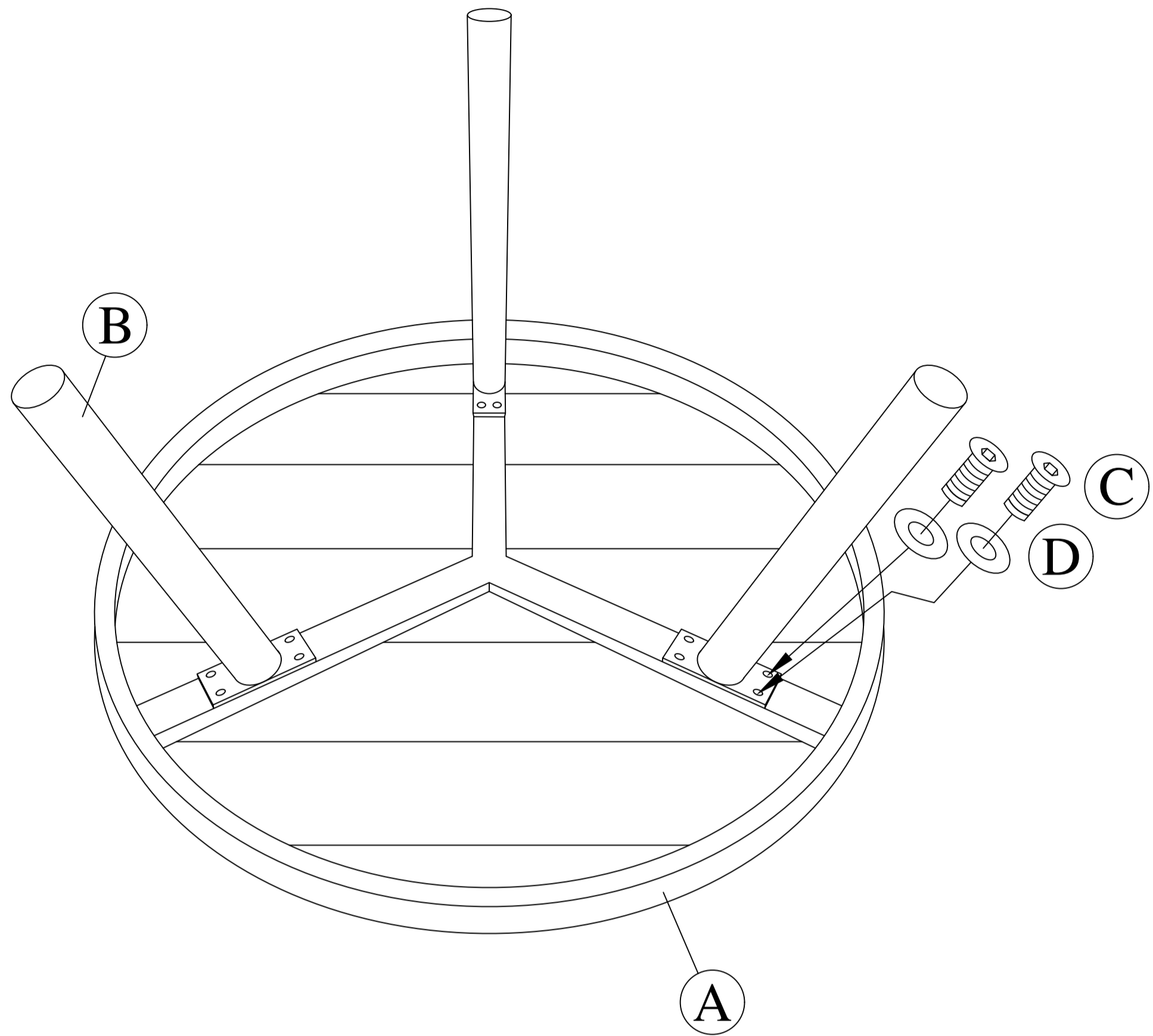
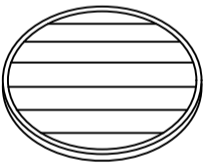
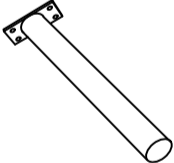
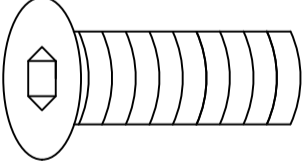
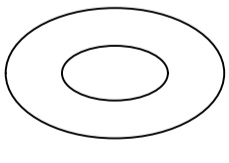
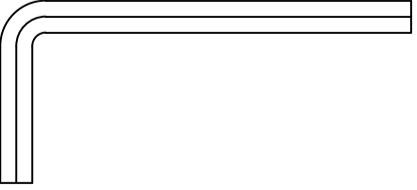
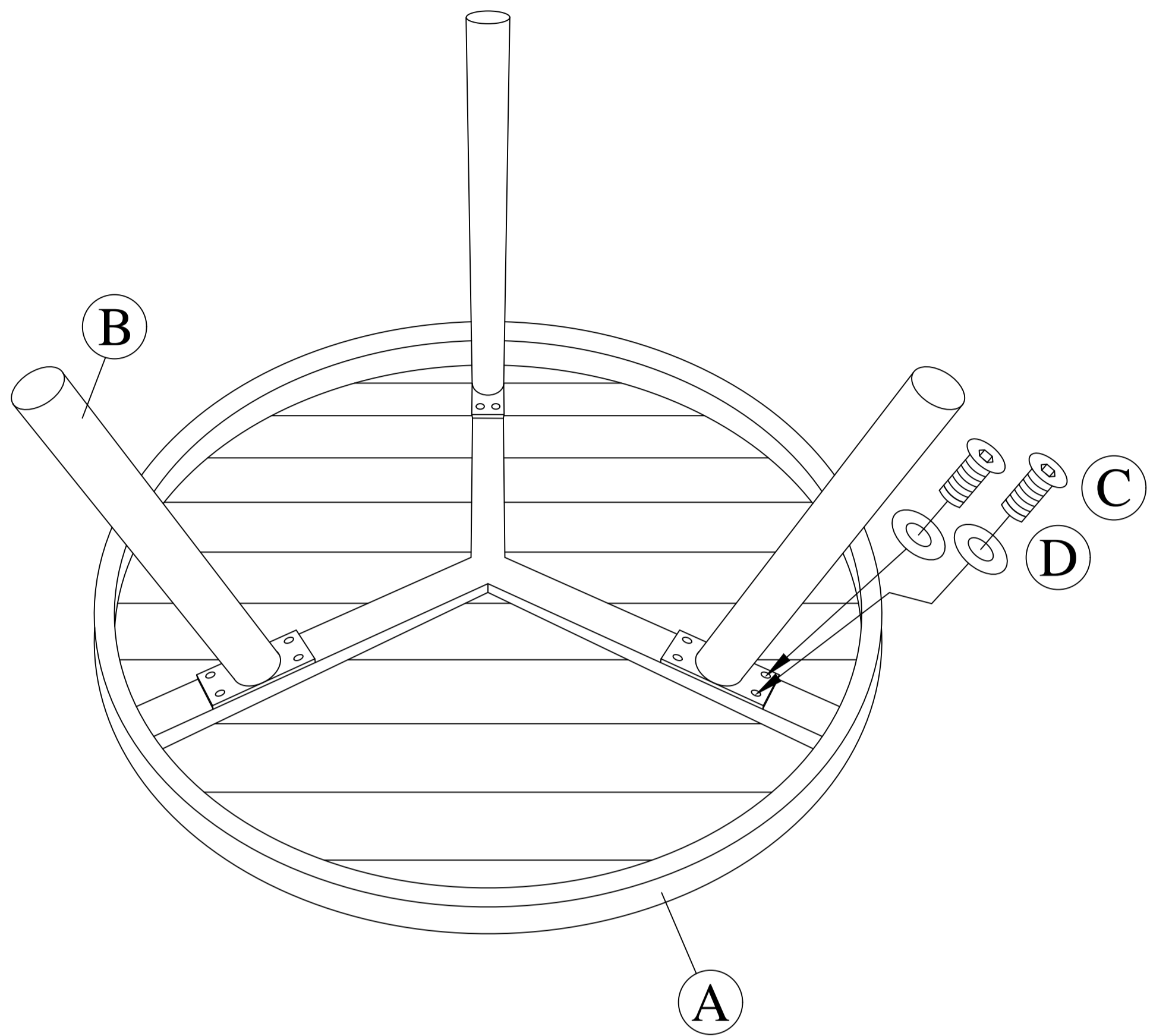
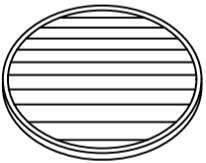
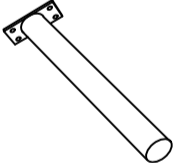
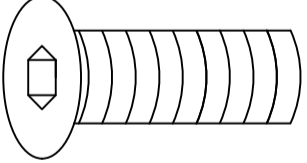
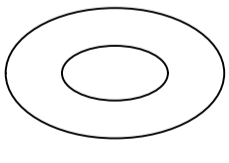
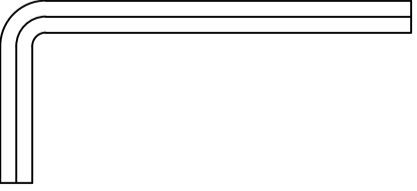
	PARTS LIST	DESCRIPTION	QTY
A		TABLE TOP	1
B		TABLE LEG	3
C		1/4"x16 mm BOLT	12
D		Ø6.5x1.0 mm WASHER	12
E		HEX BOLT DRIVER	1