

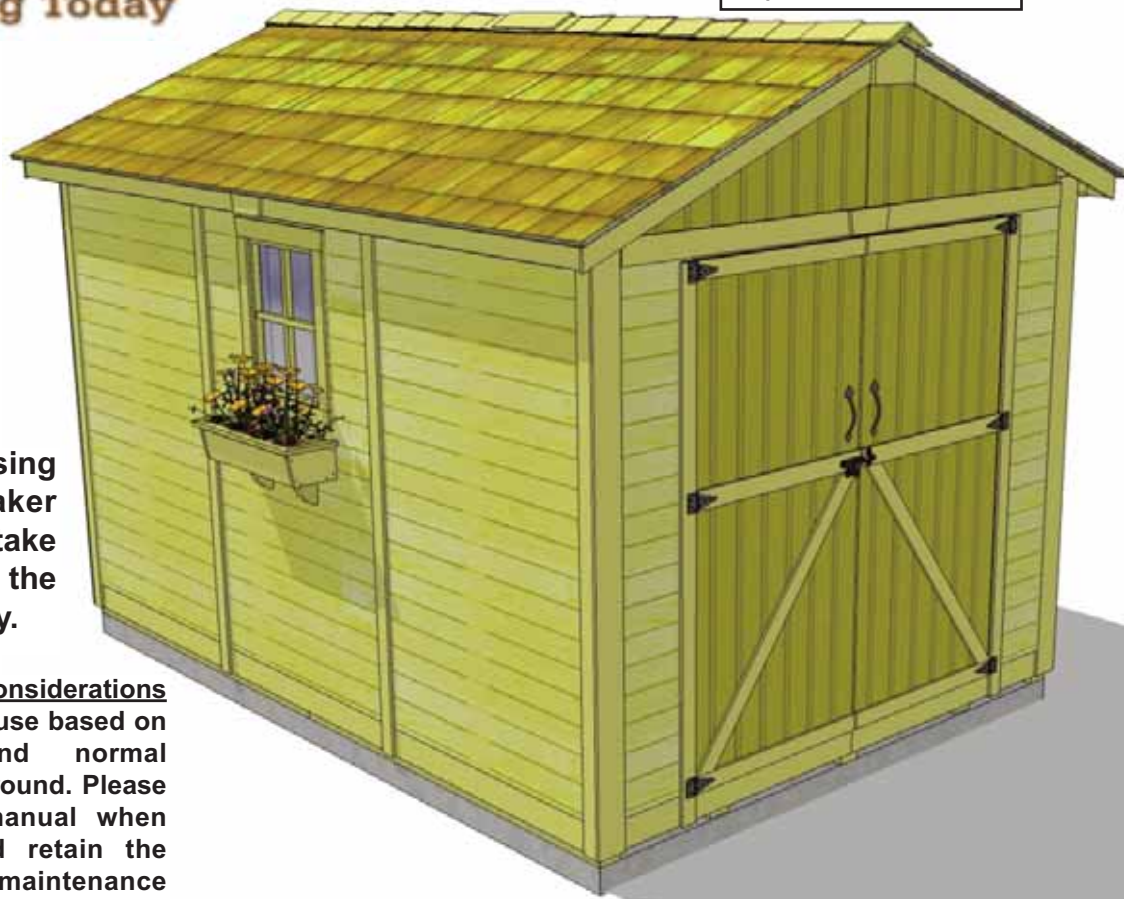

# 8x12 SpaceMaker Garden Shed Assembly Manual

Revision #25  
September 26, 2019



Thank you for purchasing our 8x12 SpaceMaker Garden Shed. Please take the time to identify all the parts prior to assembly.

#### Safety Points and Other Considerations

Our products are built for use based on proper installation and normal residential use, on level ground. Please follow the instruction manual when building your Shed and retain the manual for future maintenance purposes.

Some of the safety and usage measures you may wish to consider include:

- snow load ratings vary by geographical location. If heavy or wet snowfall occurs, it is advisable to sweep the snow off the roof(s).
- if the product is elevated, any structural and building code requirements are solely the customer's responsibility, and should be abided by.
- in high or gusty wind conditions it is advisable to keep the structure securely grounded.
- have a regular maintenance plan to ensure screws, doors, windows and parts are tight.

Customer agrees to hold Outdoor Living Today Partnership and any Authorized Dealers free of any liability for improper installation, maintenance and repair.

**In the event of a missing or broken piece, simply call the Outdoor Living Today Customer Support Line @ 1-888-658-1658 within 30 days of the delivery of your purchase. It is our commitment to you to courier replacement parts, free of charge, within 10 business days of this notification. Replacement parts will not be provided free of charge after the 30 day grace period.**

**Thank you for purchasing our 8x12 SpaceMaker Garden Shed.  
Please take the time to identify all the parts prior to assembly.**

## Parts List:

### A. Floor Section

- 3 - 45 1/2" x 75" Floor - Joist Frames
- 6 - 1 1/2" x 3 1/2" x 71 3/4" - Center Floor Joists - Unattached
- 3 - 45 1/2" x 21" - Floor Joist Frames
- 3 - 45 3/8" x 74 7/8" - Plywood Floor - Large
- 3 - 45 3/8" x 20 7/8" - Plywood Floor - Small
  
- 10- 1 1/2" x 3 1/2" x 68 3/16"- Floor Runners

### B. Wall Section

- 7 - 45 1/2" x 75" - Solid Wall Panels
- 7 - 1 1/2" x 2 1/2" x 45 1/2" Bottom Wall Plates
- 1 - 45 1/2" x 75" - Window Wall Panel
- 2 - 12" x 73" - Narrow Wall Panels

### Door Jambs & Header

- 2 - 1 1/2" x 3" x 73" - Vertical Door Jamb
- 1 - 2" x 3" x 78" - Door Header
- 2 - 2" x 3" x 6 1/2" - Door Header End Plates
- 1 - Left Side Door
- 1 - Right Side Door
- 2 - 2 1/2" x 1/2" x 72" - Interior Vertical Door Stops
- 1 - 2 1/2" x 1/2" x 68" - Interior Top Horizontal Door Stop
- 1 - 2 1/2" x 3/4" x 62 1/2" - Door Threshold
- 1 - 1/2" x 2 1/2" x 71" - Interior Door Flange

### Top Wall Plates

- 6- 3/4" x 2 1/2" x 32" - Front & Rear Top Plates  
(4 pcs angle cut one end, 2 pcs straight cut both ends)
- 4 - 3/4" x 2 1/2" x 65 3/4" - Side Top Plates (Angle cut edge)

### Gable Walls

- 4 - Gable Half Walls - Triangular Shaped

### C. Rafter Section

- 18- 1 1/2" x 3 1/2" x 56 1/2" - Roof Rafters
- 2 - 3/4" x 4 1/2" x 84" - Roof Ridge Boards
- 2 - 3/4" x 4 1/2" x 52 1/2" - Roof Ridge Boards
- 2 - 1/16" x 3" x 7" - Metal Ridge Board Connectors
- 4 - 1/2" x 4 1/2" x 68 1/4" - Soffits

### D. Roof Section

- 4 - Outside Rear Roof Panels (Shingles overhanging roof plywood on 1 end)
- 2 - Middle Roof Panel (Shingles flush with roof plywood)
  
- 3 -3/4" x 3 1/2" x 72" Roof Gussets - (angle cut on ends)
- 4 - 3/4" x 2 1/2" x 48" Facia/Roof Nailing Strips

### E. Miscellaneous Section

#### Bottom Skirting

- 10 - 1/2" x4 1/2" x 45 1/4" - Side Bottom Skirting

#### Corner & Sidewall Trim

- 8 - 1/2"x 2 1/2" x 79" - Narrow Trims
- 3 - 1/2" x 2 1/2" x 77 1/2" - Doorway / Rear Wall Trims
- 4 - 1/2" x 2 1/2" x 75" - Filler Trim
- 4 - 1/2" x 4 1/2" x 82" - Wide Corner Trim
- 4 - 1/2" x 4 1/2" x 44 1/2" - Horizontal Gable Trim

#### Facia Trim

- 4 - 3/4" x 3 1/2" x 58" long - Front and Rear Facia  
(Angle cut on ends - 2 right / 2 left)
- 4 - 3/4" x 3 1/2" x 71 3/4" long - Side Facia)

#### Filler Shingles (5 1/2" wide)

- 16 pcs - Long
- 4 pcs - Short

#### Ridge Caps

- 22 - Cedar Roof Ridge Caps

#### Misc. Pieces

- 1 - Window Insert
- 1 -Window Trim Pkg - (1-24 1/16" angle cut / 3 -23" straight cut)
- 1 - Flower Box Kits
- 2- Pentagon Facia Plate
- 4 -Facia / Trim Detail Plates
- 1 pc - Spare Wall Siding
- 2 pcs - Spare Shingles- use to shim door, etc

Note: We recommend you drill a 1/8" pilot hole for each screw, to avoid splitting wood. The hole depth should be equal to 3/4 the length of screw.

**Advice:** Wood has a tendency to split when screwing near the ends of a board. To prevent splitting, it is always recommended to pre-drill pilot holes before screwing into these areas.

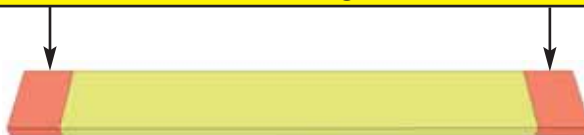

**Note:** All Trim, Facia and Bottom Skirting pieces will be positioned rough face out when installed.

# 8x12 SPACEMAKER HARDWARE PACKAGE

## Hardware Kit (Provided)

2 1/2"  x 330

2"  x 200

2"  x 38  
Black Headed

1 1/4"  x 260

3/4"  x 17  
Silver

3/4"  x 24  
Black Headed

1 1/2"  x 50  
Shingle

1 1/2"  x 336  
Finishing

 x 2  
Square Drive Bit



Tee Hinge x 6



Door Handle x 2



Barrel Bolt



Single Rafter Bracket x 6



Double Rafter Bracket x 4



Simpson Strong Tie (Roof) x 8



Ridge Board Connector x 2



Cane Bolt

## Tools Required (Not Provided)



Hammer



Screw Gun/Drill



Tape Measure



Wood Clamp



Utility Knife



Level



Pliers



Ladder



1/8" & 1/2" Drill Bits

## Safety Equipment Required (Not Provided)



Safety Glasses



Work Gloves

# A. Floor Section

Exploded view of all parts necessary to complete Floor Section. Identify all parts prior to starting. Note: Floor Footprint is 96" wide x 136 1/2" deep.

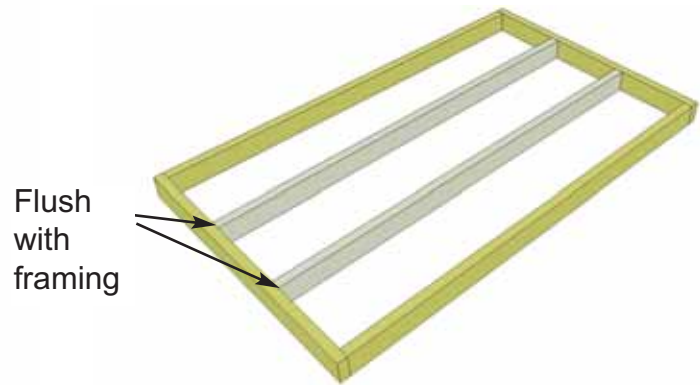
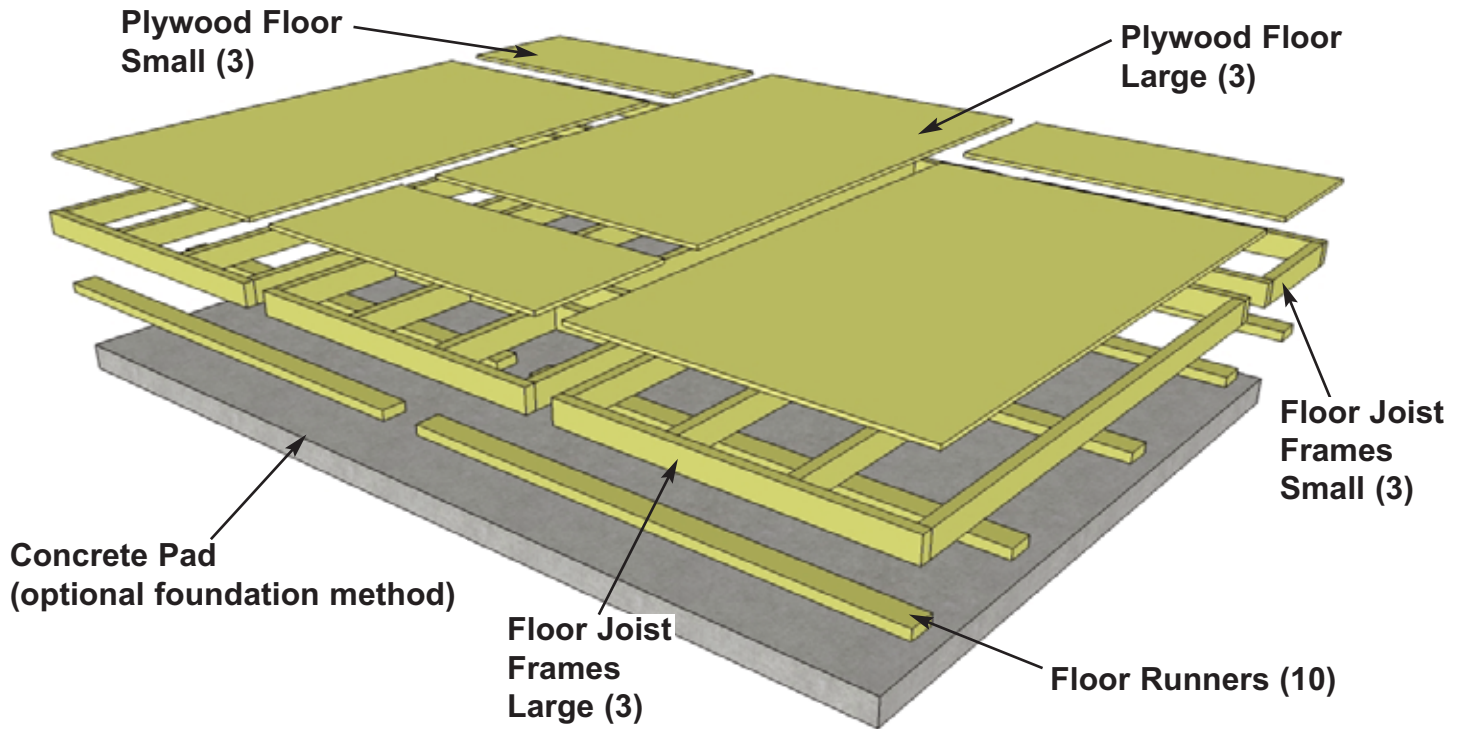

**1.** Lay out **Large Floor Joist Frame** and **2 Floor Joists** as illustrated above. Position Joists equally in Floor Joist Frame. Use **Small Floor Joist Frame** as a template to determine joist position. Position Joist so flush with framing.

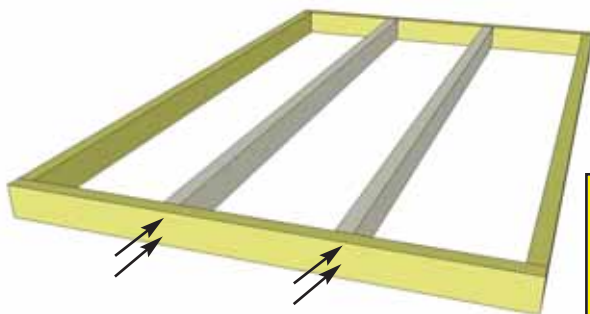

You can find the Square Drive Bit for the screws in the Hardware Kit Bag.



**2.** When correctly positioned, attach each Joist with 4 - 2 1/2" screws (2 per end). You can find the Square Drive Screw Bit in the Hardware Kit Bag.

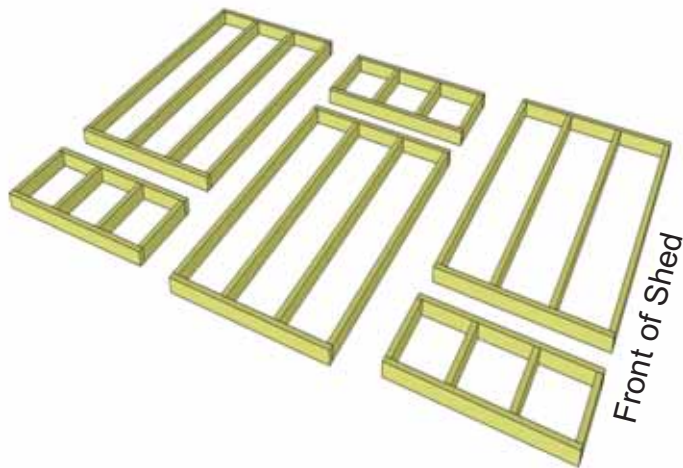

**3.** Lay out **Floor Joist Frames** as illustrated at left. There are 3 larger and 3 smaller Frame Sections. The Footprint for the floor when attached together will be **136 1/2" deep x 96" wide**.

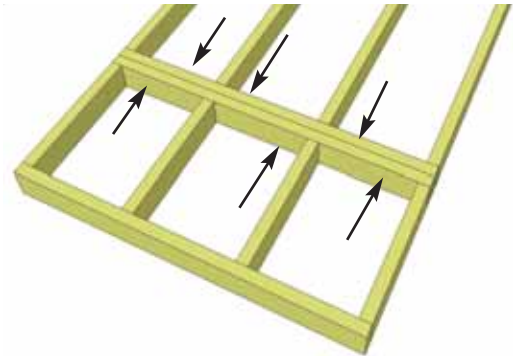

**4.** Attach each large and small floor joist frame together with 6 - 2 1/2" screws per section.

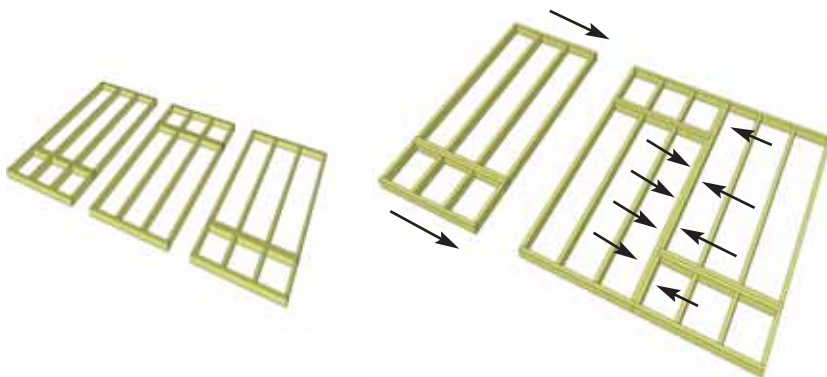

**5.** Complete all large and small frame attachments. Screw each completed section together with 8 - 2 1/2" screws.

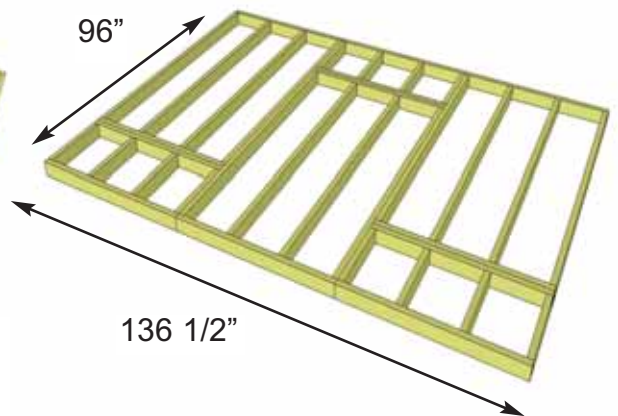

**6.** When completed, your floor footprint should be 136 1/2" deep x 96" wide.

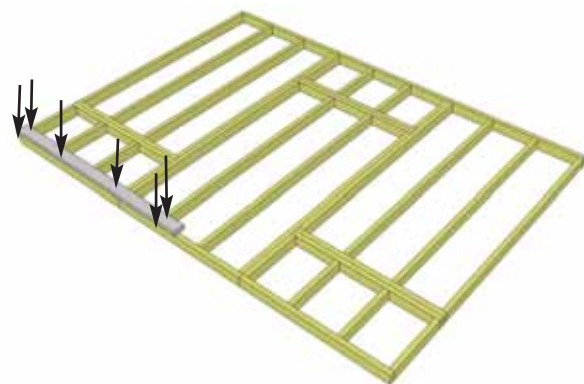

**7.** Attach **Floor Runners** to completed floor frame. There are 2 floor runners per 136 1/2" side and 5 completed runners in total. Use 6 - 2 1/2" screws per Runner.

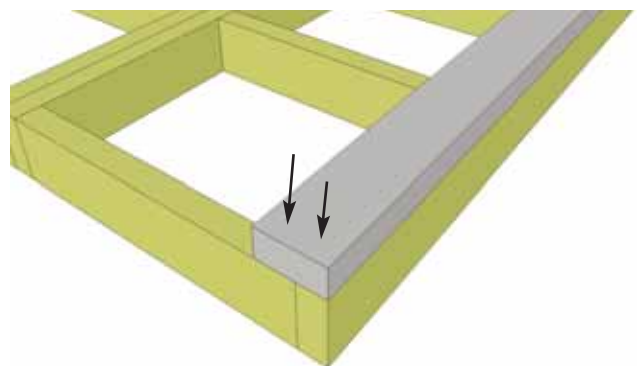

**8.** Make sure Runners are flush with outside and front and rear floor framing but not overhanging.

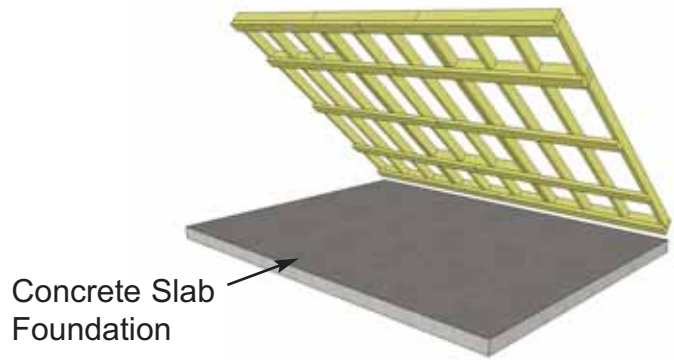
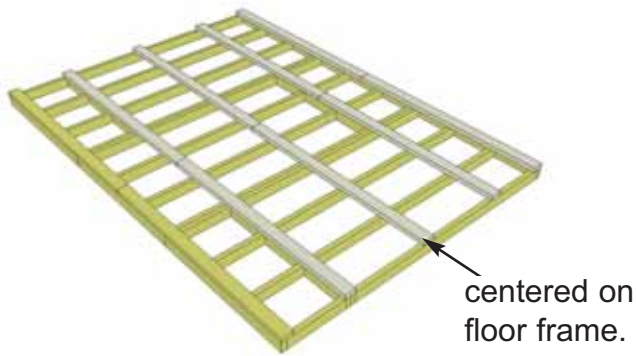

**9.** Complete all Floor Runners.

**Foundations**

**Note:** The floor will be flipped over and floor runners will sit on your foundation. It is important to note that having a level foundation is critical. Choosing a foundation will vary between regions. Typical foundations can be concrete pads or patio stones positioned underneath the floor runners.

**10.** With Floor Runners attached, carefully flip the floor over and place on your foundation. **Caution:** you will need 2 people to assist you. Be careful when laying floor down not to bend or twist floor. When in place, level floor completely.

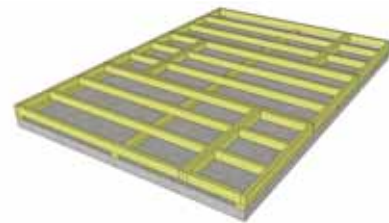

**11.** Position **Plywood Floor** pieces (6) on top of completed floor joists. The Plywood is cut slightly smaller than floor framing. Keep plywood seams tight.

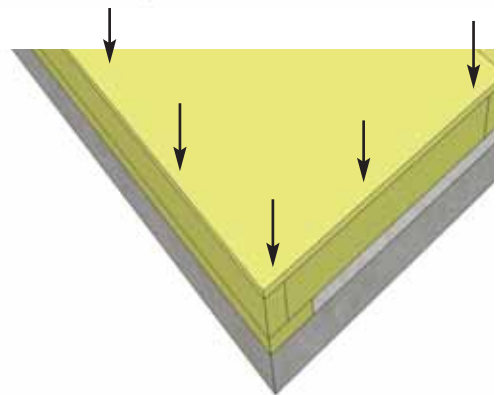
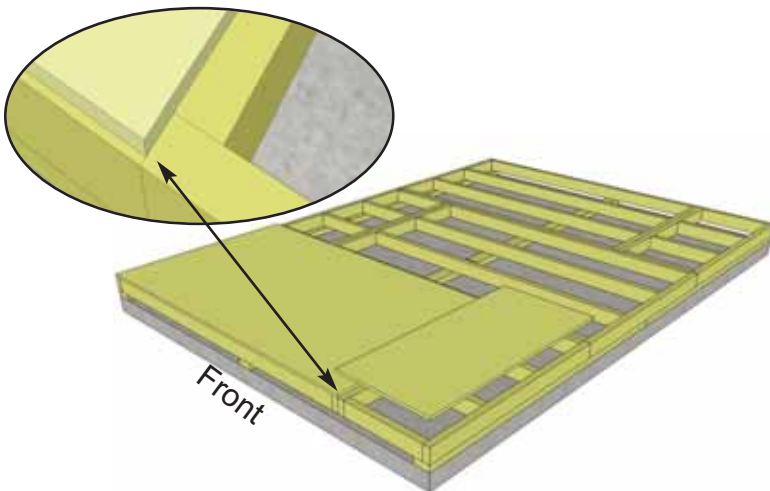
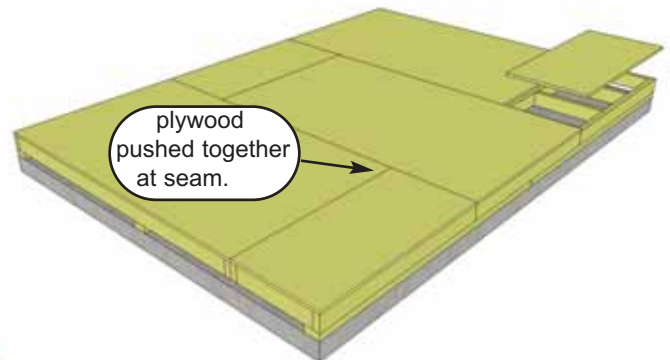

**Hint:** Use a chalk line to mark location of floor joists to determine screw placement.

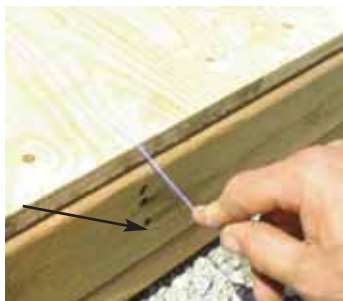

**12.** With Plywood positioned correctly on floor framing, attach with 1 1/4" screws. Use screws every 16".

# B. Wall Section

Exploded view of all parts necessary to complete the Wall Section. Identify all parts prior to starting.

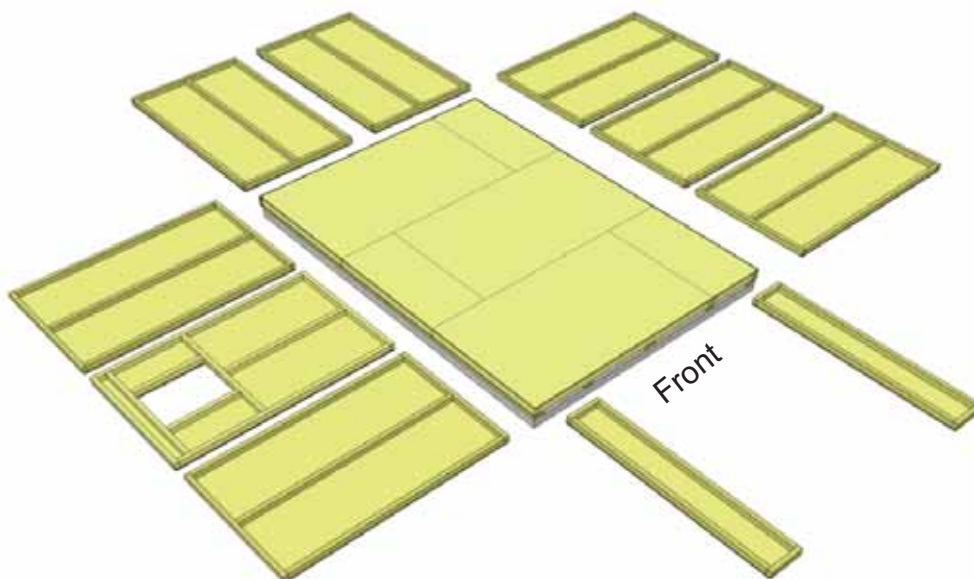
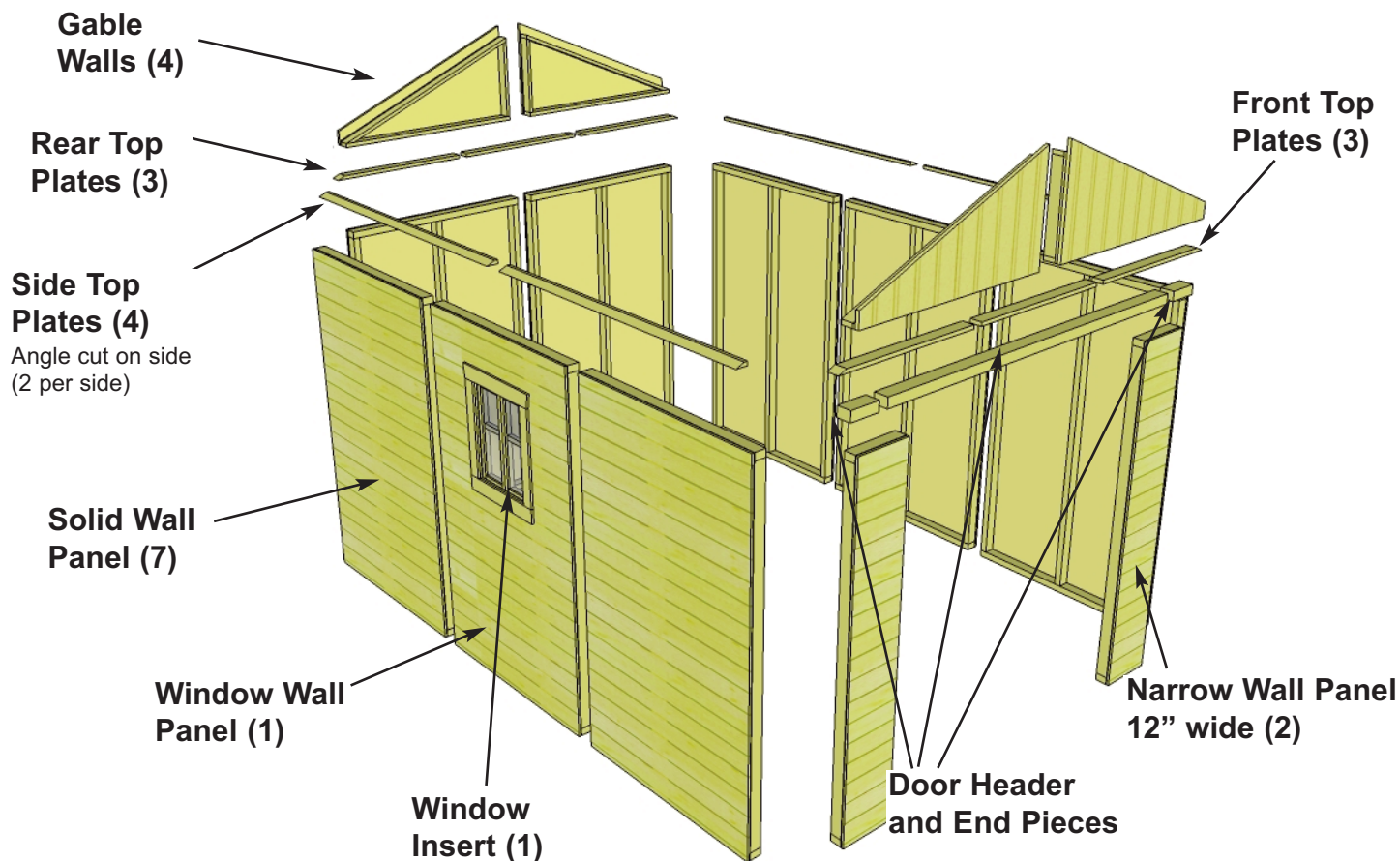

**13.** Lay out all the wall panels and become familiar with their location. On a Standard Kit, there is **1 Window Wall Panel, 7 Solid Wall Panels and 2 Narrow Wall Panels** for the front. Make sure to position panels right side up so water is directed away from and not into shed. Look at window wall panel to compare and determine proper wall position.

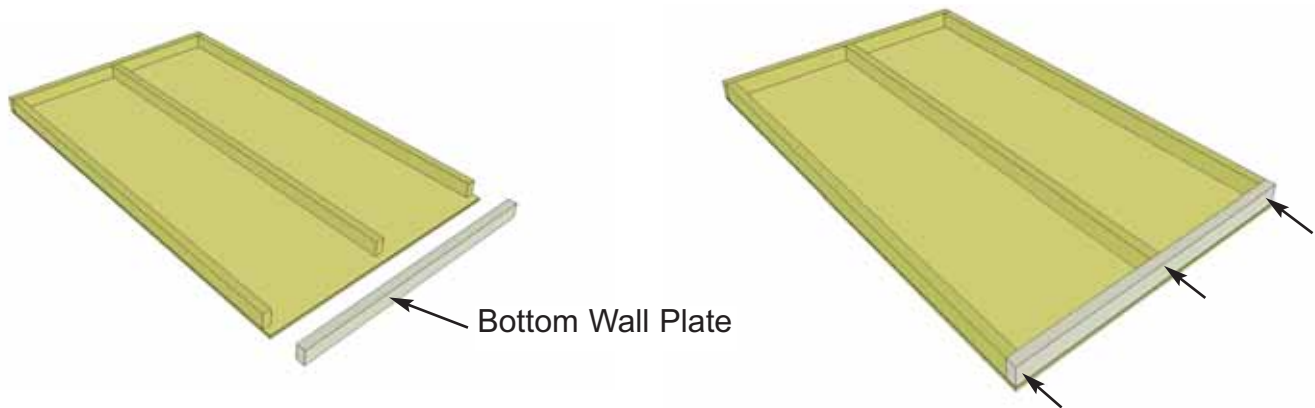

**14.** Starting with **Solid Wall Panels**, carefully lay panel face down. Position and attach **Wall Plate** to bottom of wall studs of each wall panel with 3 - 2 1/2" screws. Position so plates are flush with framing.

**15.** Starting at Rear Corner, position a Solid Wall Panel on top of plywood floor. The Wall Panel bottom framing will sit flush with floor framing. Wall siding will overhang the floor by 1/2".

**Important:** Make sure all walls are aligned in their upright position. If not, water may leak into your shed. Unsure if panel is facing up or down? Check and compare siding on window wall panel to match alignment.

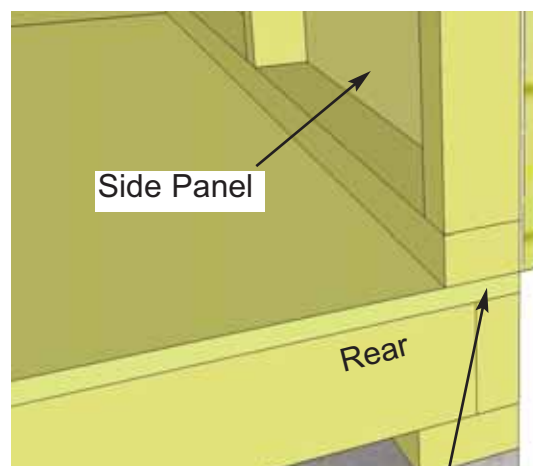
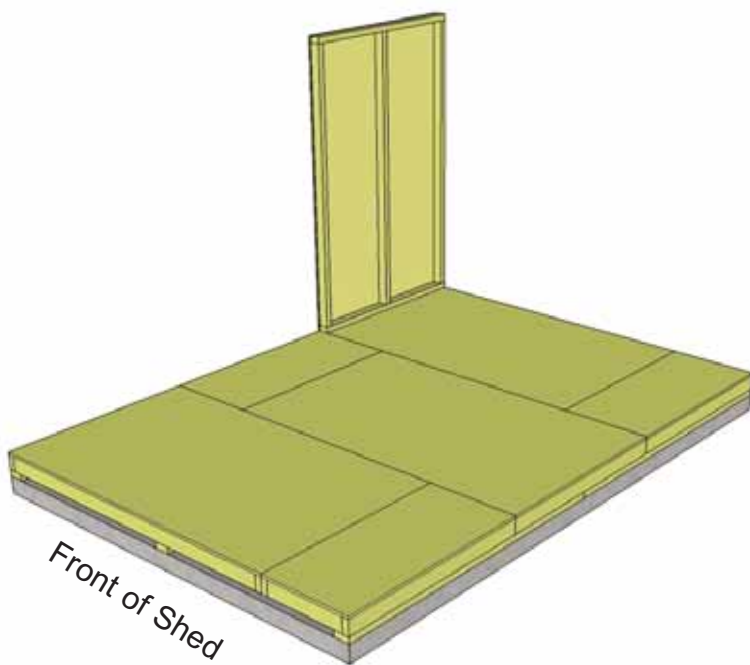

**16.** The side wall panels will sit flush with floor framing at corners, and the rear panels will be sandwiched between them. **Note:** Siding will overhang the floor by approx. 1/2" .

Outside 2x3 framing of wall panel is flush with outside of floor framing when properly aligned.



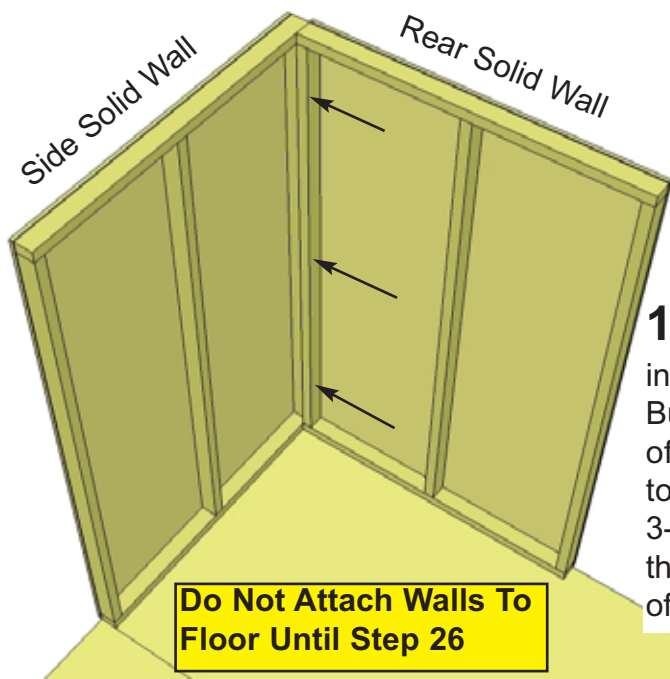

**17.** Position rear solid wall into place on plywood floor. Butt both vertical wall studs of side and rear walls together and attach with 3- 2 1/2" screws. Screw at the bottom, middle and top of stud to secure properly.

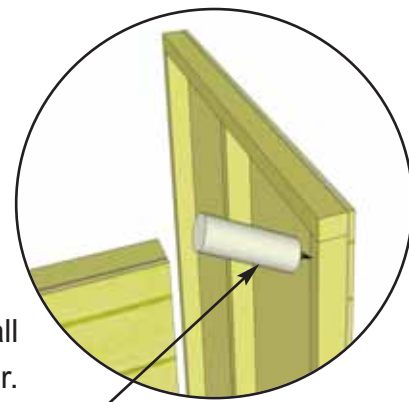

**Optional** - Caulking seams will help prevent moisture from entering your shed. **Caulking not included in kit.**

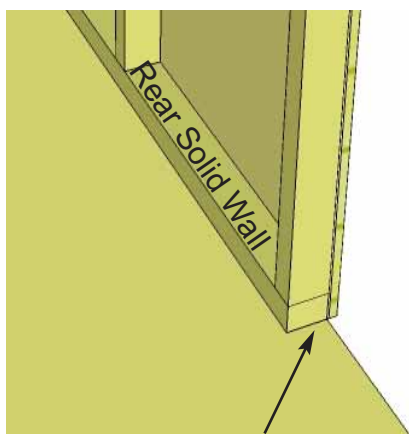

2x3 wall framing flush with floor framing.

**18.** With the corner wall attachment complete, position rear wall so bottom 2x3 wall framing is sitting flush with floor framing. Wall siding should overhang floor by approximately 1/2". When positioned correctly, add a second rear wall panel and attach both rear wall panel studs together as per **Step 17**.

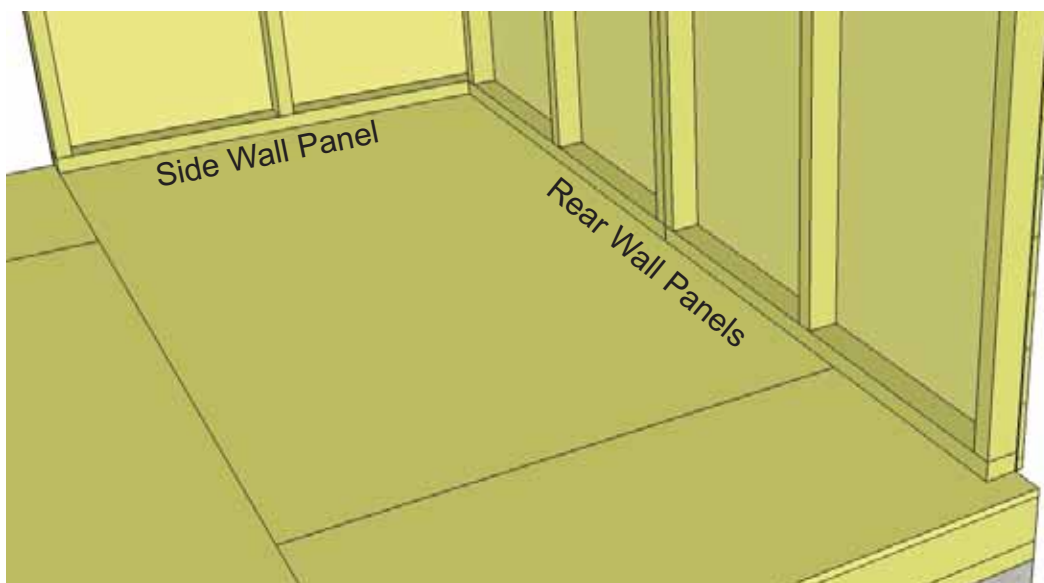
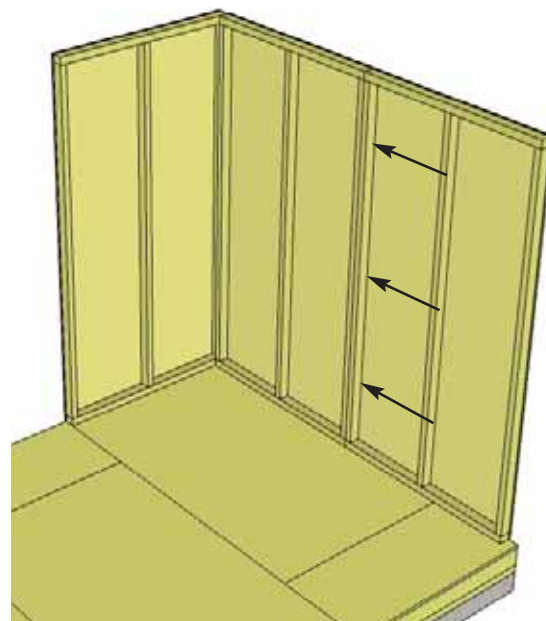

Be sure that rear wall panels fit between the side wall panels (sandwiched)

Note: We recommend you wait to install the windows last, so they don't get damaged during construction.

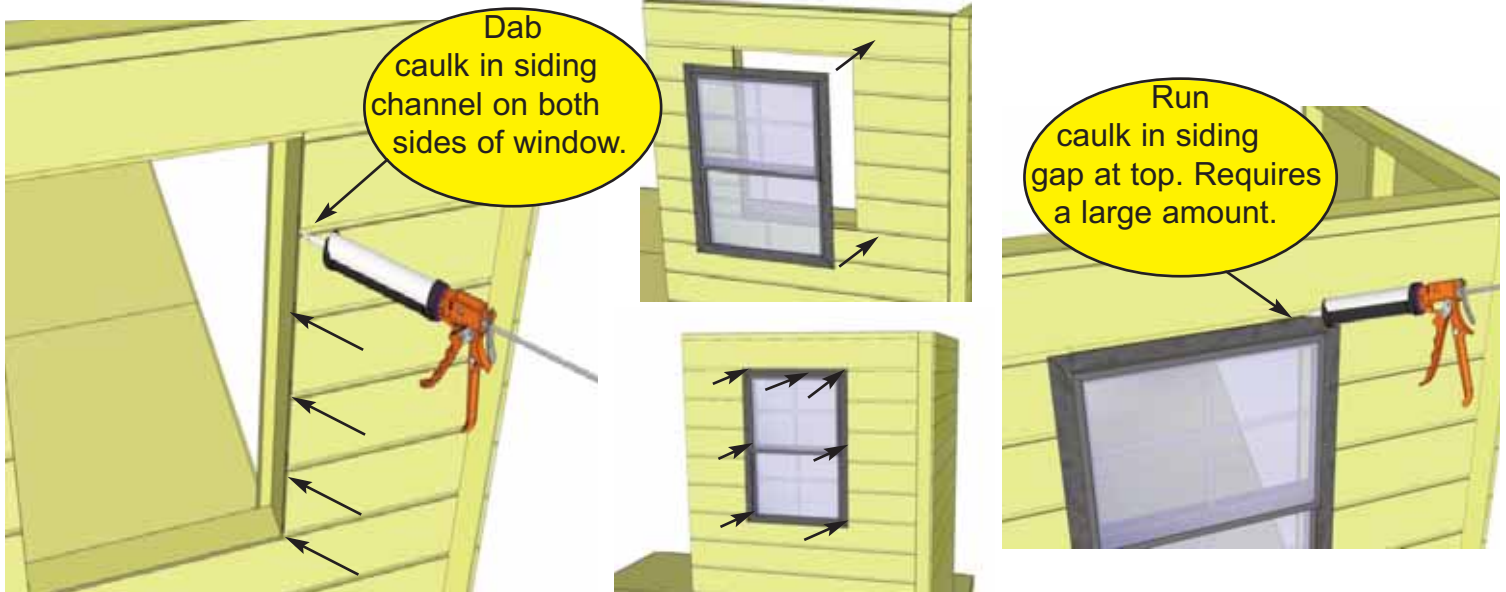

**19.** Locate **Window Inserts for Regular Window Walls**. Before installing, dab caulk in siding channel on both sides of window opening. This will prevent water from getting in behind window. Position window in cavity and secure with 8 - 1 1/4" screws. Caulk gap between siding and window at top. This requires a large amount of caulking but is important to fill. Later, Window Trims will be installed to hide caulking. Complete Window Inserts as walls are erected or complete in **Step 25**.

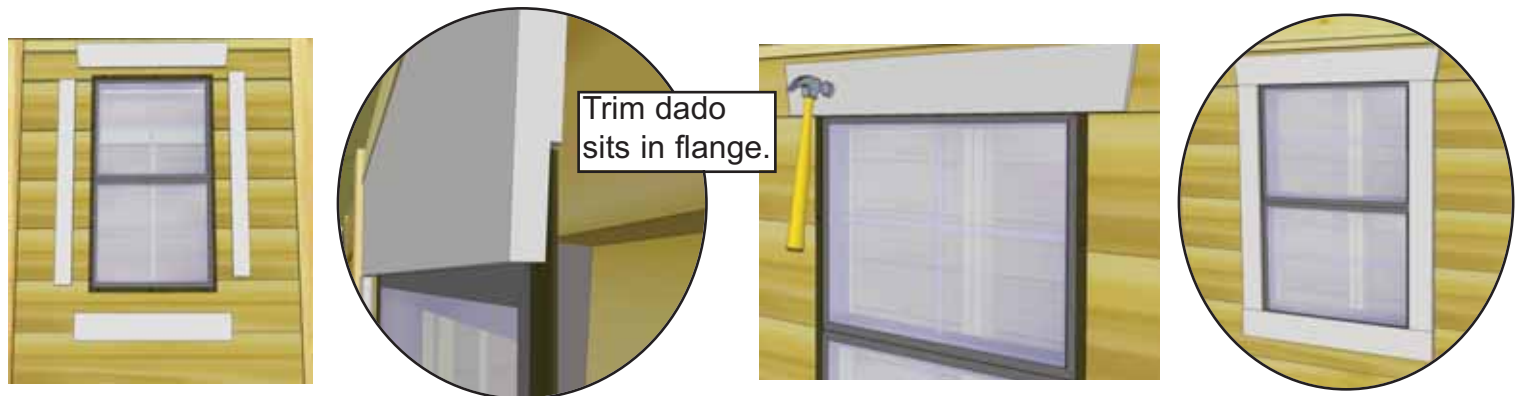

**19a.** Position Window Trim around window doing a dry run first and attach with 4 - 1 1/2" finishing nails per piece. There are two Trim Kits (Regular / Narrow). The regular window kit = 1 x 24 1/16" = top (angle cut on ends) / 3 x 23" = Sides & Bottom. Narrow window kit = 1 x 19 7/8" Top, 2 x 21 7/16" Sides, 1 x 18 3/4" Bottom. Window trim has a small dado on reverse face. Outside flange of window will roughly sit in the dado to give a better fit.

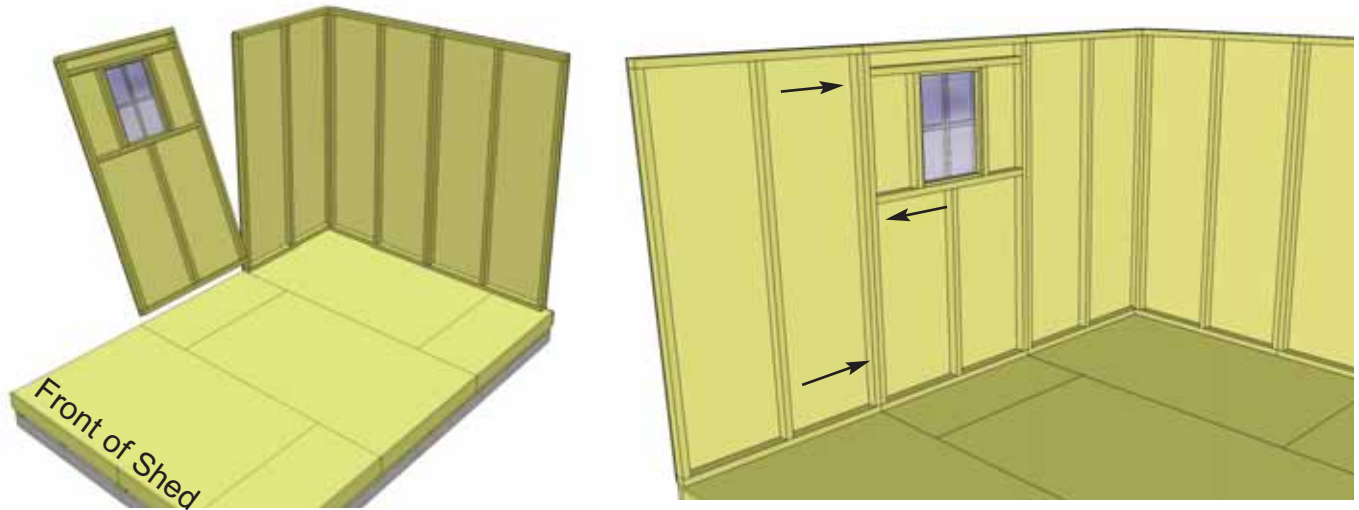

**20.** Next, complete all side wall panel attachments. Typically, Window Wall Panel is positioned in middle of side. Attach wall studs together as per **Step 17**.

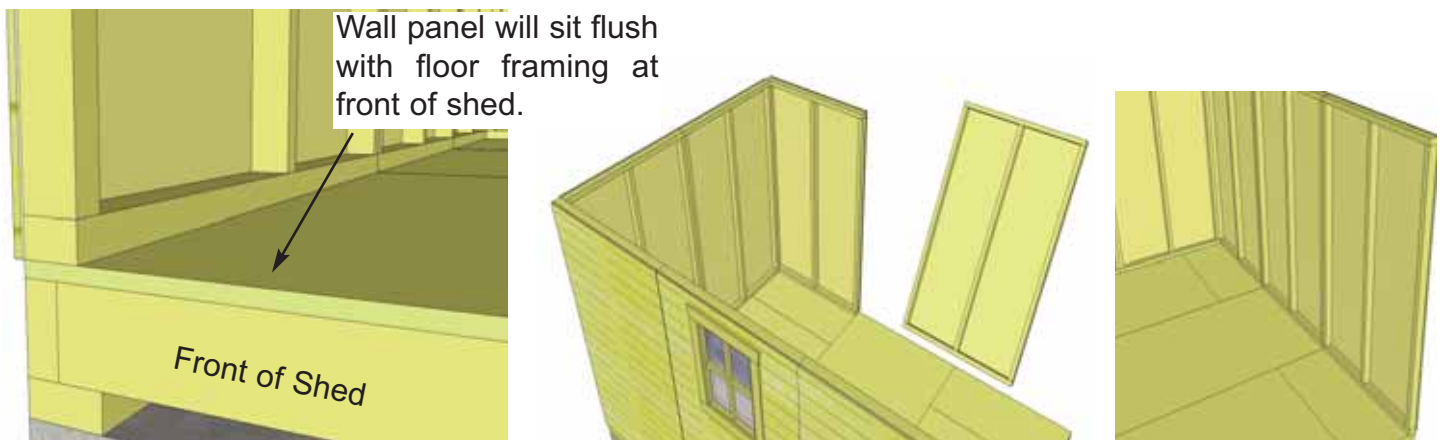

**21.** Complete all remaining side wall attachments. Attach wall studs together as per **Step 17**.

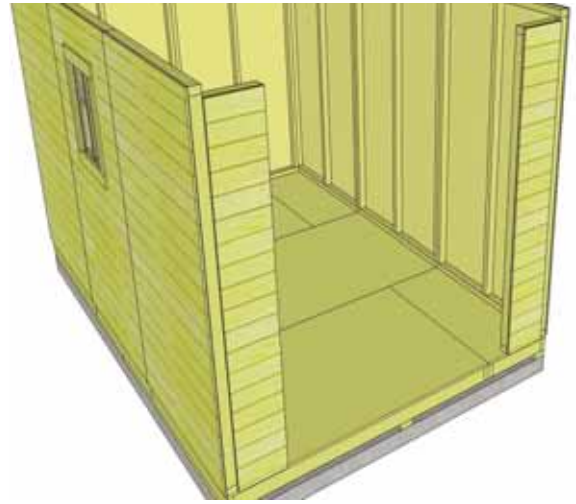
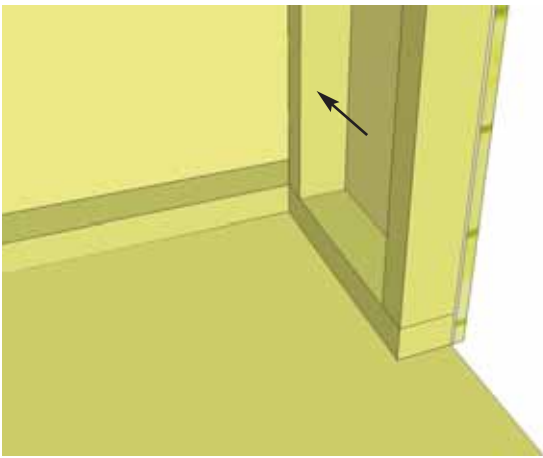

**22.** Complete both Narrow Wall attachments making sure 2x3 wall framing is flush with floor framing, and siding of wall is overhanging the floor by approximately 1/2".

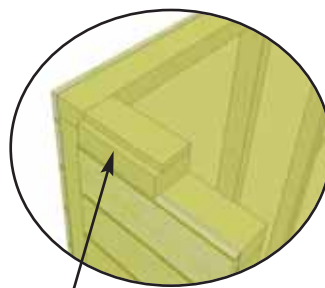
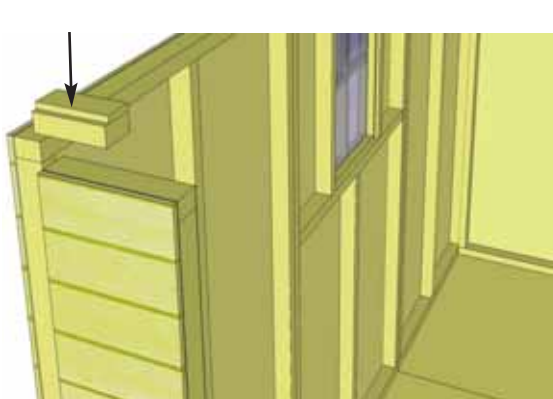

Dado cut facing to the top and outwards.

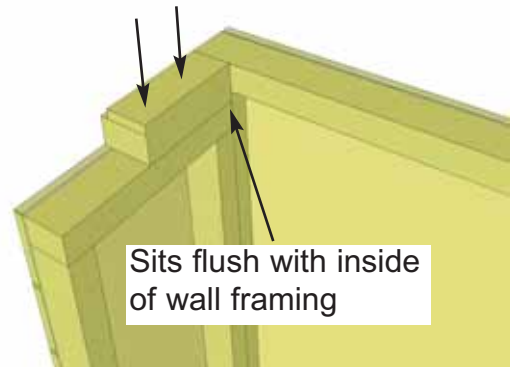

Sits flush with inside of wall framing

**23.** There are 2 - 6 1/2" Door Header End Plates. Align dado cut on top facing outward and flush to inside of wall framing. Attach each with 2 - 2 1/2" screws as illustrated above.

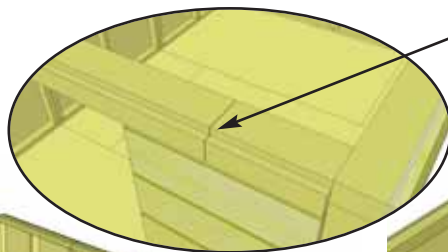

Make sure joints are tight. Push walls in if required.

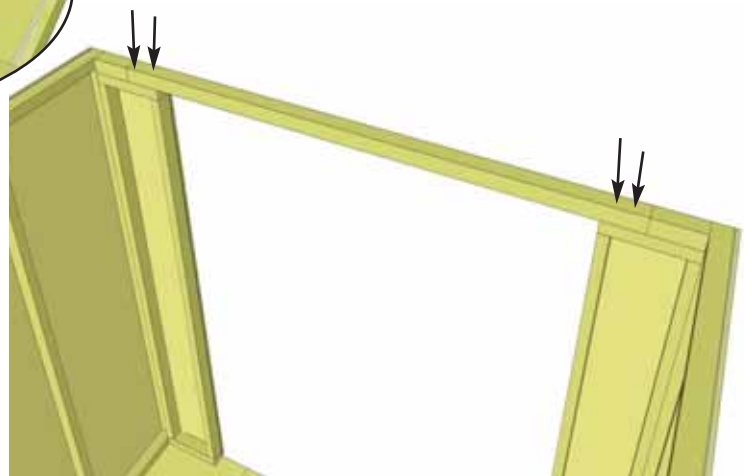
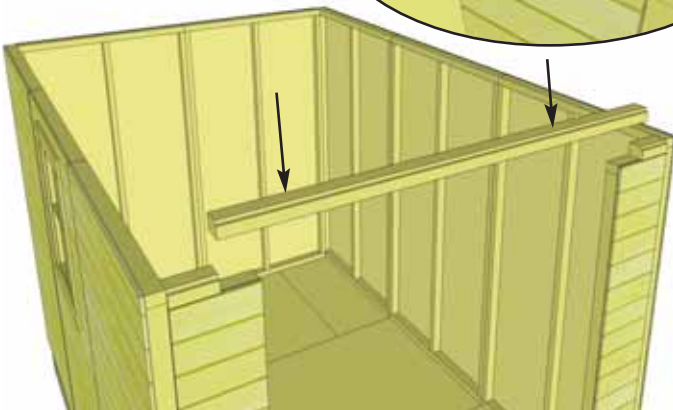

**24.** Position Door Header (78"long) with dado cut facing outwards between End Plates. Push walls together so joints are tight together. Secure Header to Narrow Wall framing with 2 - 2 1/2" screws per side.

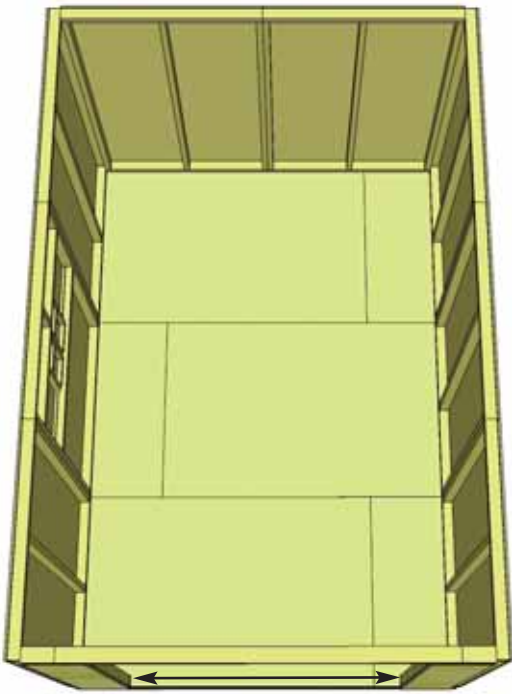

Confirm 67" Wide Door Opening at Bottom

**25.** When all walls are attached together, check alignment with the floor. Bottom wall framing should sit flush with outside of floor framing. Confirm 67" wide door opening at bottom. When positioned correctly, fasten bottom wall plates to floor using 4 - 2 1/2" screws per wall panel.



Angle screws into perimeter Floor Joists.

**Optional** - Caulking seams will help prevent moisture from entering your shed. Caulking not included in kit.

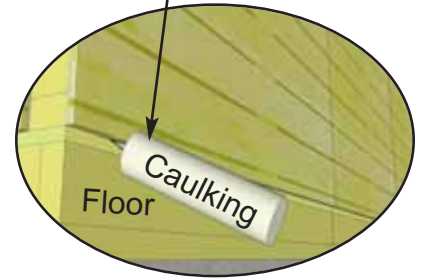

**26.** Position **Front Top Plates** on top of wall studs so they are flush on the inside with Door Header. There are 3 pieces of Front Top Plates (2 end plates, angle cut on 1 end, and 1 middle plate, straight cut on both ends). Together, the plates should be centered evenly on the wall left to right. Attach by screwing down into Door Header with 4 - 2" screws.

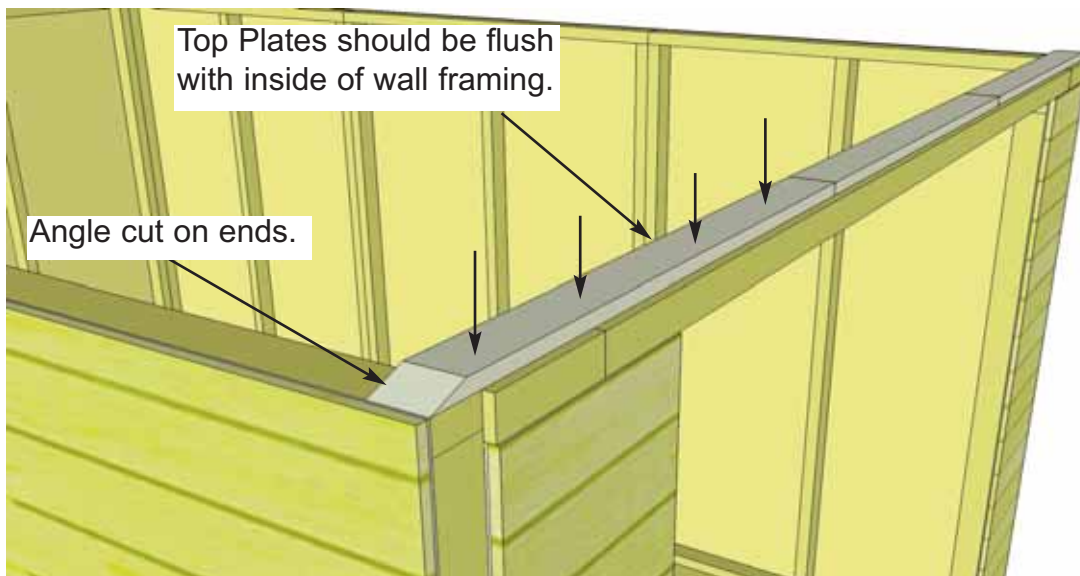
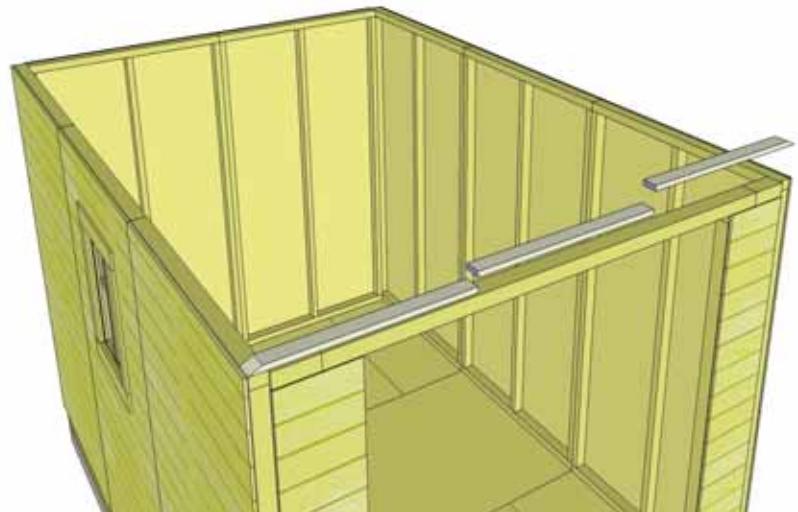

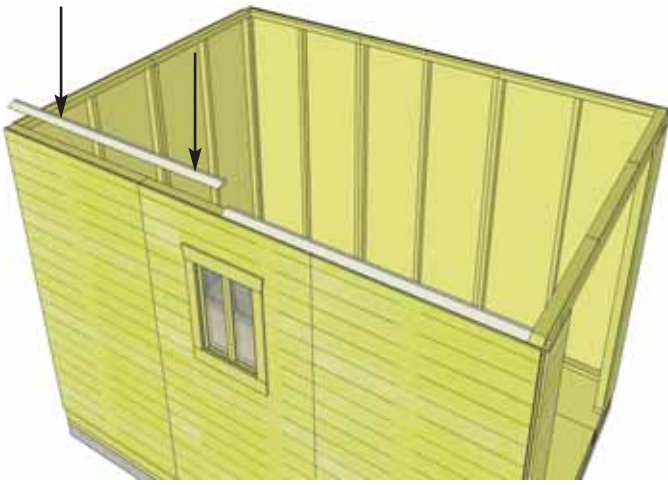

**27.** Next, attach the **4 Side Top Plates** (2 per side). The side top plates are angle cut down the length. Once again, position top plate on wall plate so it is flush with inside of wall plate. Side plate should also be flush with Front Top Plate. Secure with 4 - 2" screws per piece.

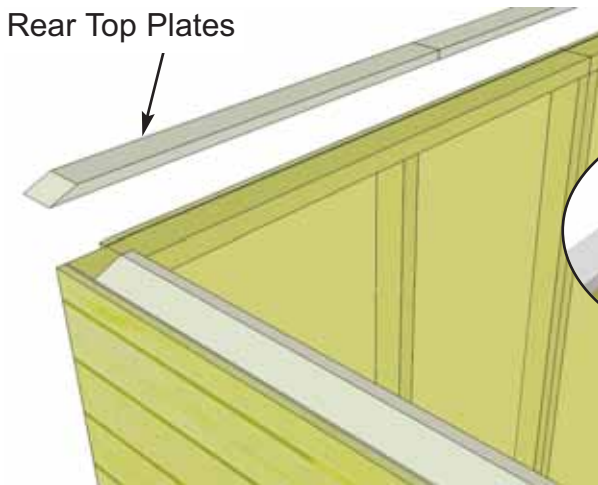
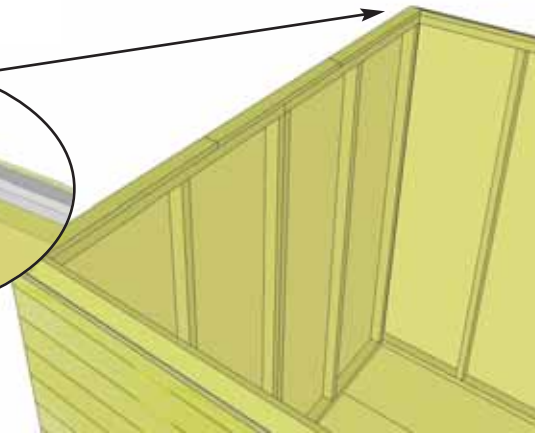
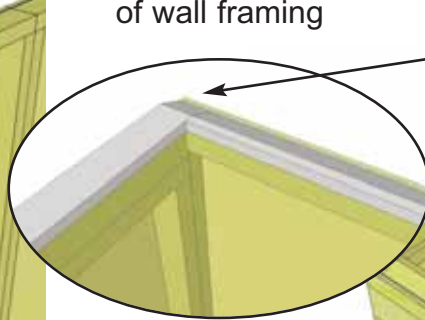
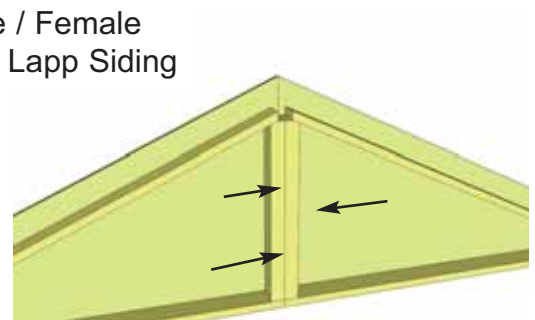
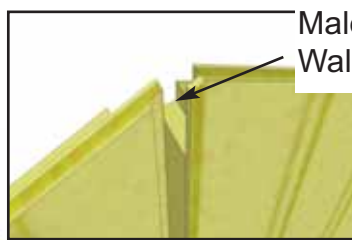
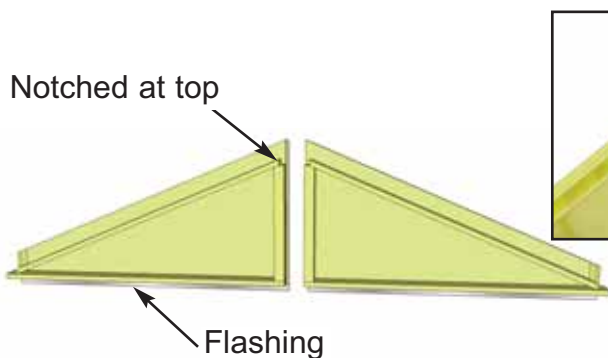

Plate flush to inside of wall framing



**28.** Position the Rear Top Plates on rear wall top framing to complete. Use 4 - 2" screws per piece.



**29.** Locate Gable 1/2 Walls for both sides of the shed. Align framing and wall siding lapp together. Screw center wall framing of each piece together with 3 - 2 1/2" screws. **Note:** prior to attaching, try each combination of Gables for best fit.

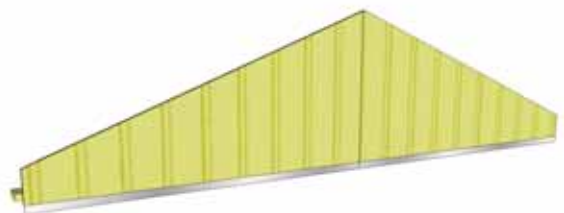

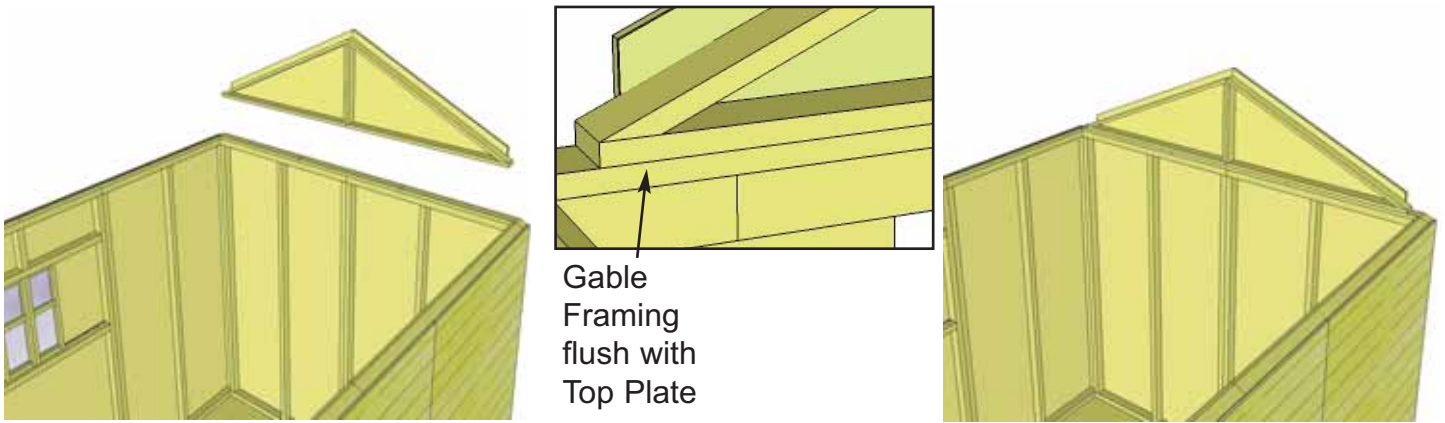

**30.** Lift up a completed gable section and place on top of Rear Top Plate on wall. The rear gable framing should sit flush with the inside of the top plate.

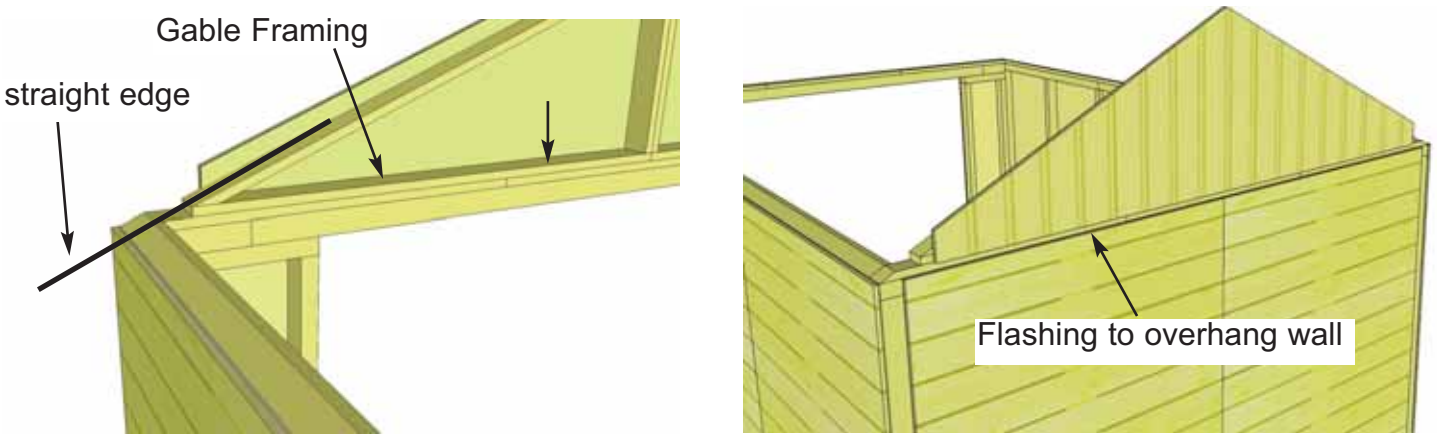

**31.** The gable should be centered sideways (left to right) on the top plate. **Hint:** use a straight edge to check the angle of the gable framing and top plate. Both angles should line up. Adjust gable accordingly.

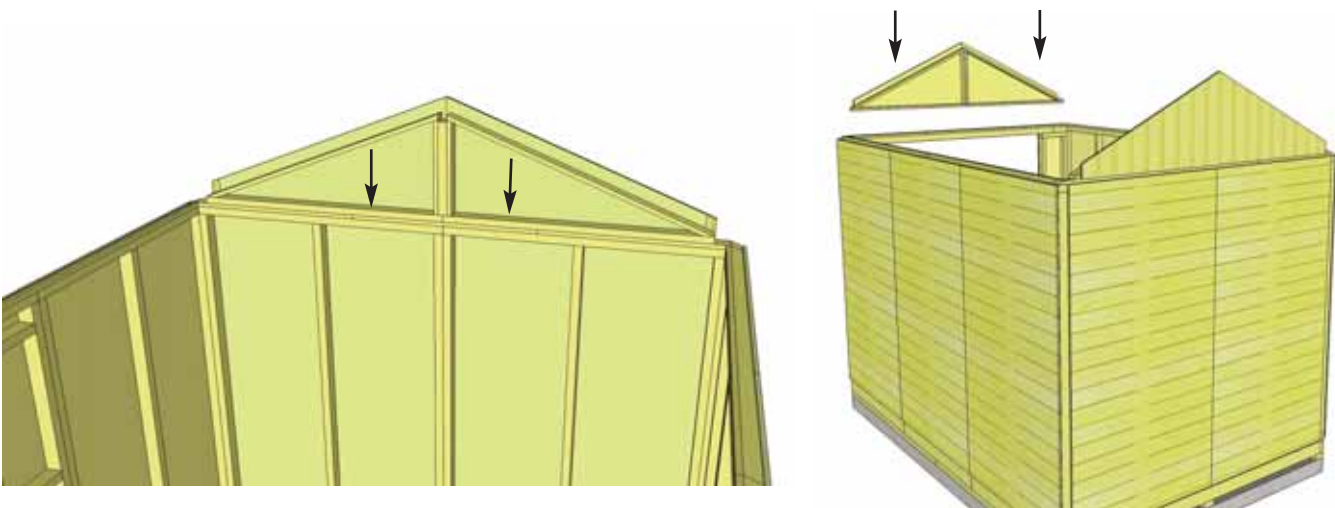

**32.** Temporarily attach gable to walls and top plate with 2 - 2" screws. Gables may need slight adjustment in **Step 44**. Complete attachment in **Step 44** with additional 6 - 2" screws. Screw from the bottom of gable framing down into Top Plate and Wall.

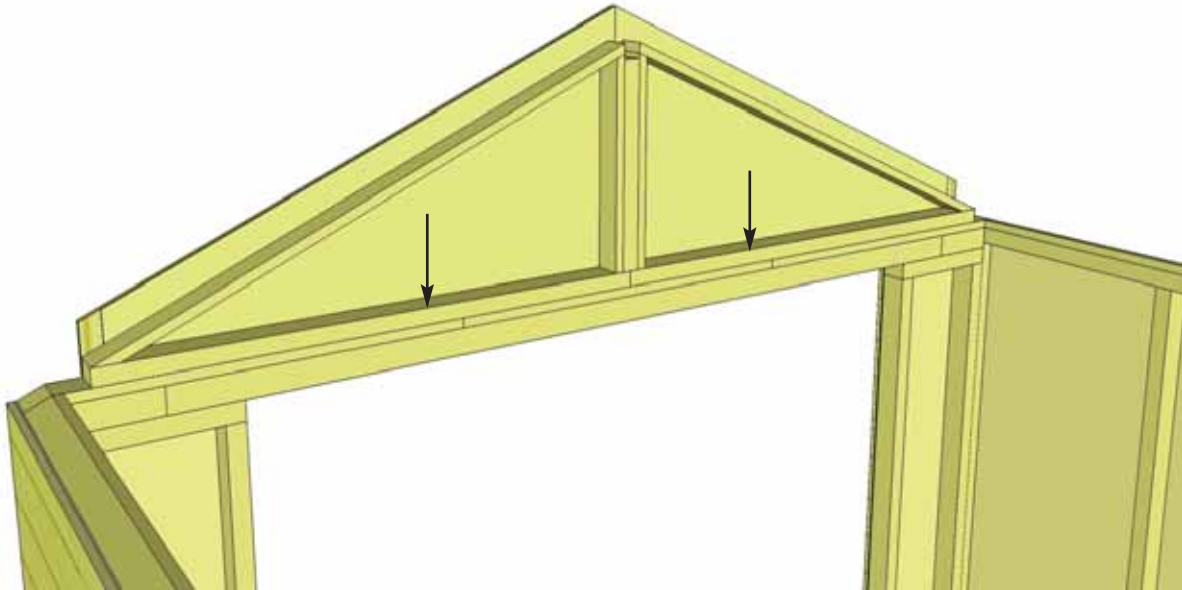

**33.** Complete positioning and attachment of front gable as per **Step 32**.

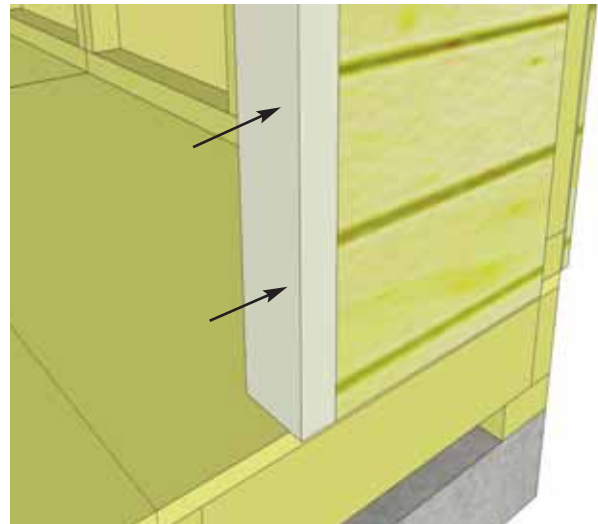

**34.** Locate both Vertical Door Jambs and position flush against front narrow wall stud. The Jamb is 3" wide and will sit flush to outside of wall siding. When positioned correctly, secure Jamb using 4 - 2 1/2" screws. Complete both sides.

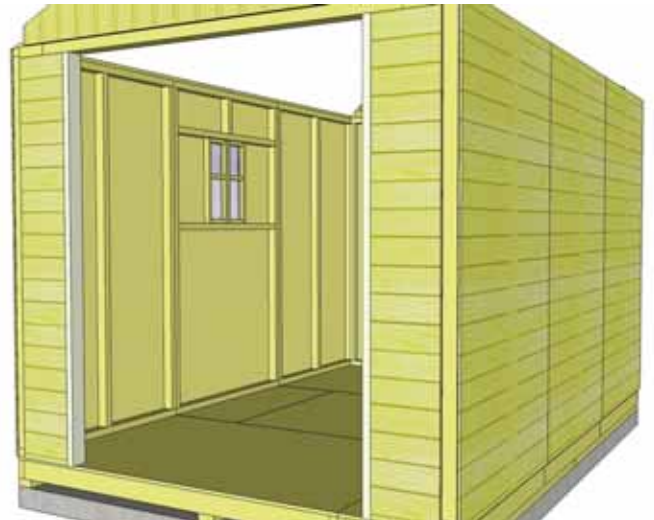



# C. & D. Rafter and Roof Section

Exploded view of all parts necessary to complete the Roof Section.  
Identify all parts prior to starting. (Roof Filler Shingles Missing)

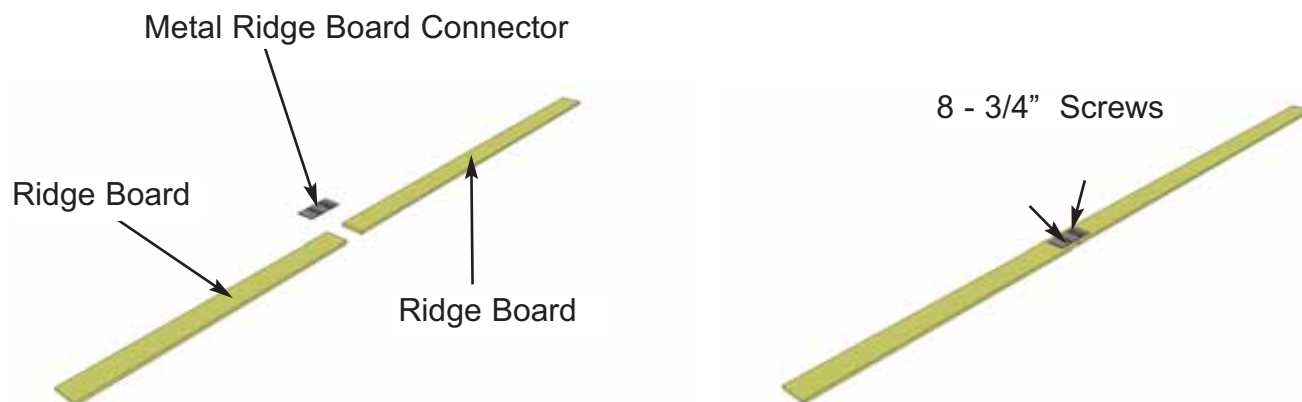
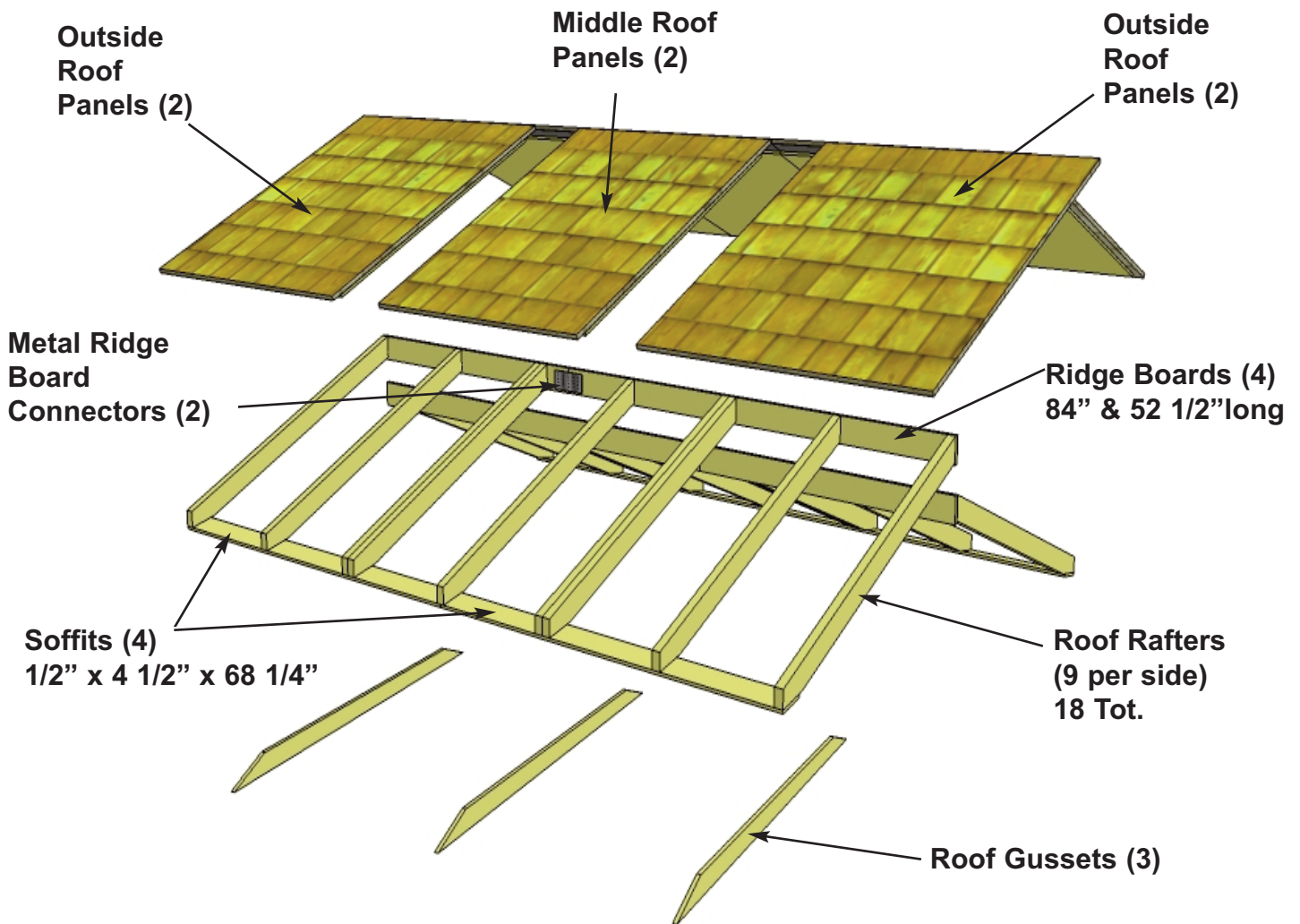

**35.** Locate (1 each) 3/4" x 4 1/2" x 84" & 52 1/2" **Ridge Boards** and attach together with **Metal Ridge Board Connector** using 8 - 3/4" screws. Total Length when connected is 136 1/2". Complete two Sets. Position Metal Ridge Board Connector evenly on Ridge Boards.

**36.** Locate 9 **Rafters**, 2 **Soffits** and completed Ridge Board. Lay out on level ground as shown to the right. Double up Rafters as illustrated. Screw doubled up Rafters together with 3 - 2 1/2" screws per piece. **Note:** completed rafter section will be flipped over in **Step 38**.

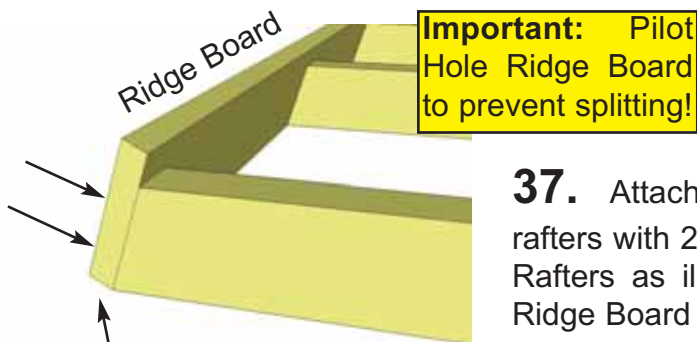
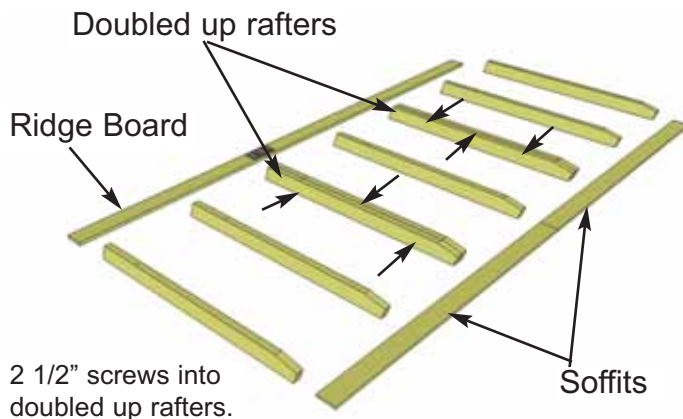

**37.** Attach completed Ridge Board to ends of both outside rafters with 2 - 2" screws per end. Measure and position interior Rafters as illustrated below. When positioned correctly, attach Ridge Board to remaining rafters with 2 - 2" screws /rafter end.

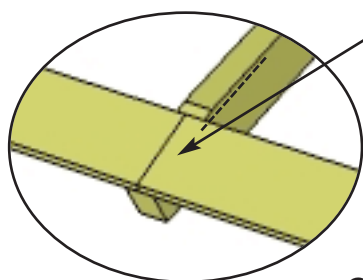
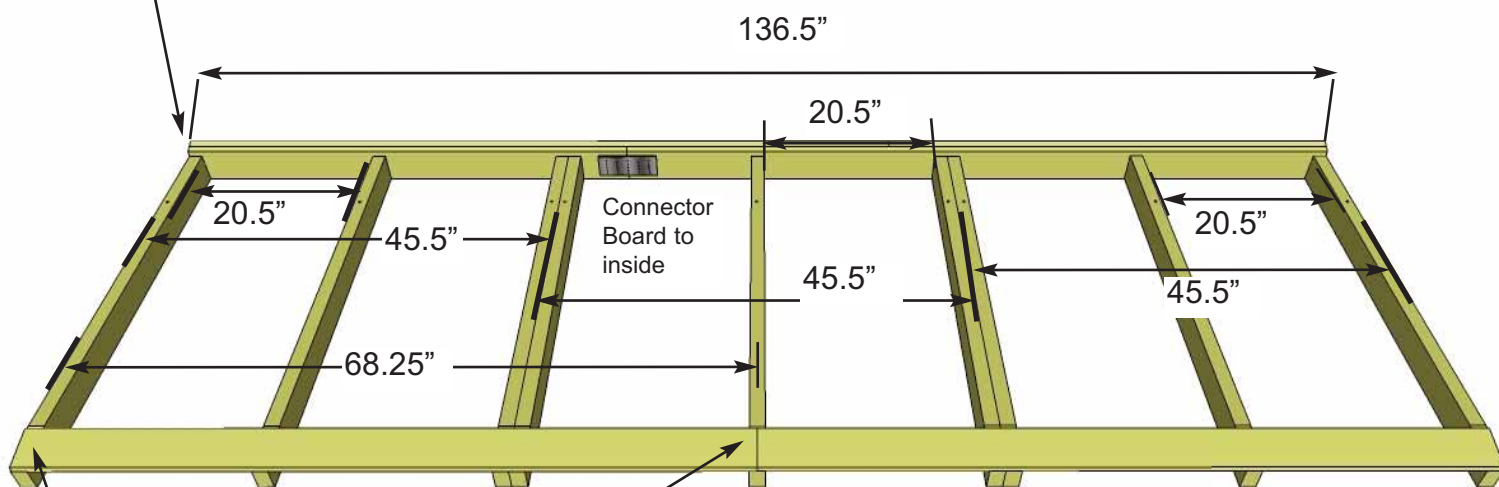

**Flip Rafter Sections over when complete**

**Important: Pilot Hole Soffit to prevent splitting!**

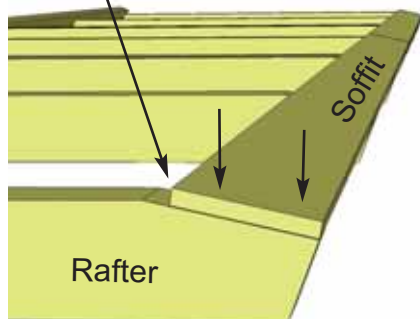

**38.** Attach end of a 68 1/4" long Soffit Board flush to ends of outside rafters with 2 - 1 1/4" screws per rafter end. Drill pilot hole in Soffit ends to prevent splitting. Complete both outside rafter / Soffit connections first. Measure and position interior Rafters as illustrated above. When positioned correctly, attach Soffits to remaining rafters with 2 - 1 1/4" screws /rafter. Flip completed rafter section over. Complete 2nd Rafter section now as per **Steps 35 - 37** with the following exception. **When attaching Ridge Board to Rafter ends, make sure Metal Ridge Board Connector is positioned so offset to first Rafter Section. See Step 43 for illustration.**

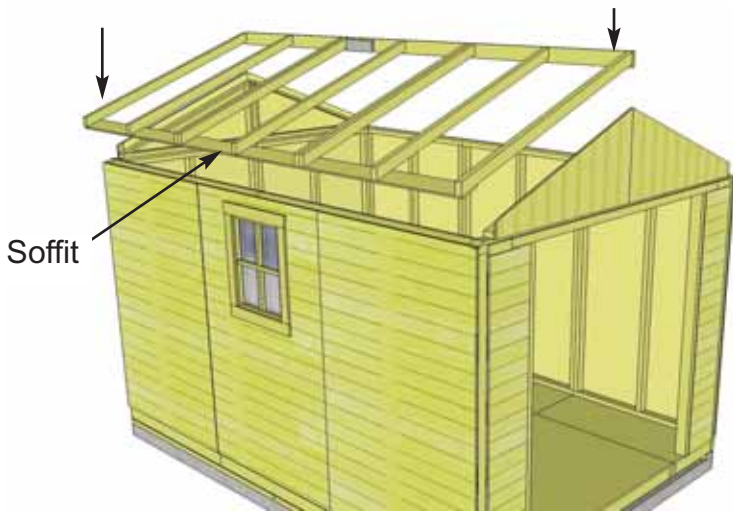

**39.** Starting with one side, lift completed rafter section up. (make sure Soffit is facing down).

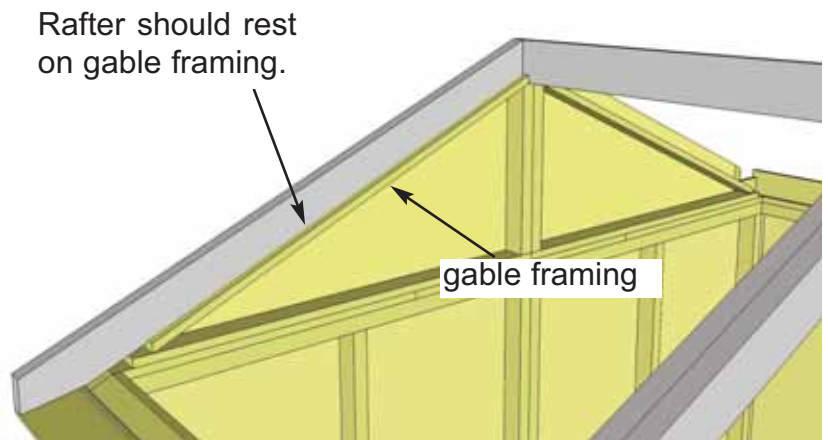
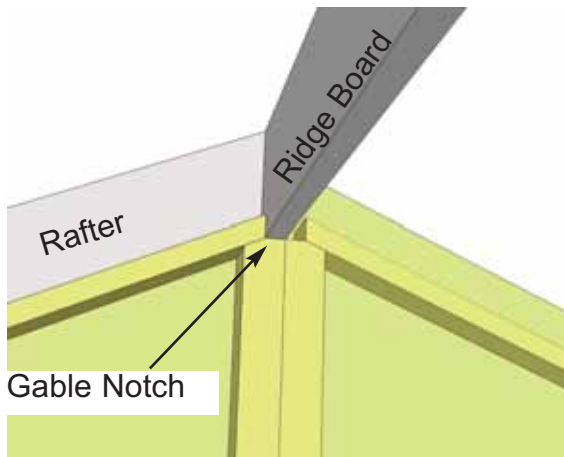

**40.** Slide Rafter Section up on gable framing until bottom of Ridge Board slips into gable notch.

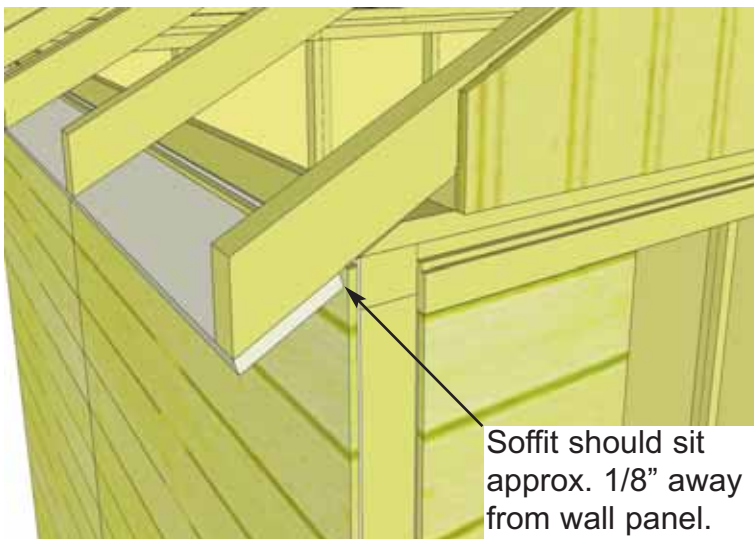

**41.** When Rafter Section is correctly positioned, outside rafters will sit equally on gable framing and Soffit will sit approximately 1/8" away from wall panels.

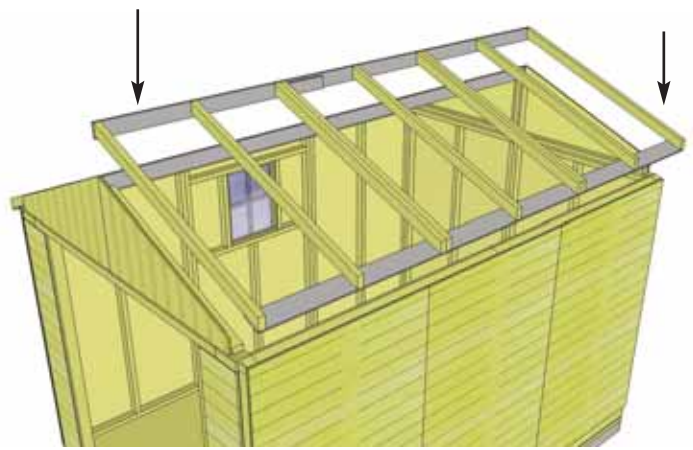
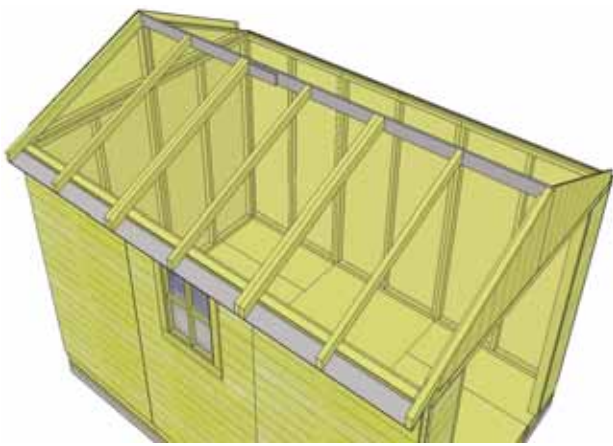

**42.** Place 2nd completed Rafter Section on gable wall framing. Position as per **Steps 39 & 40.**

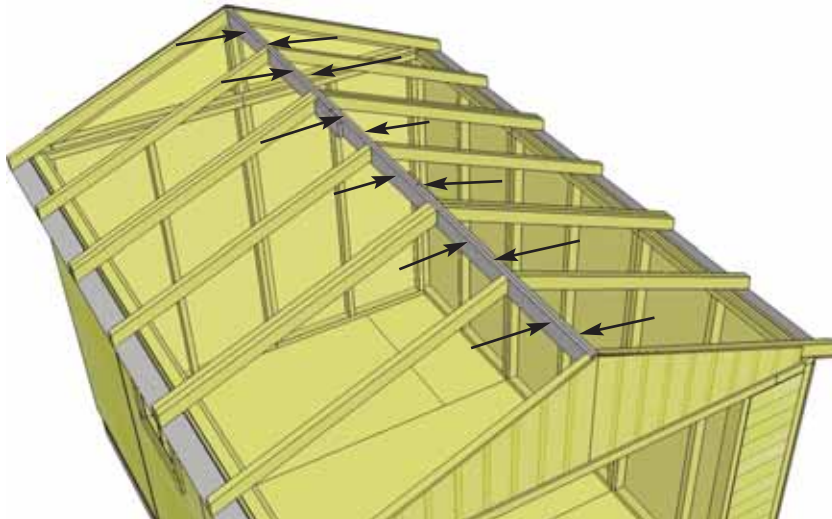
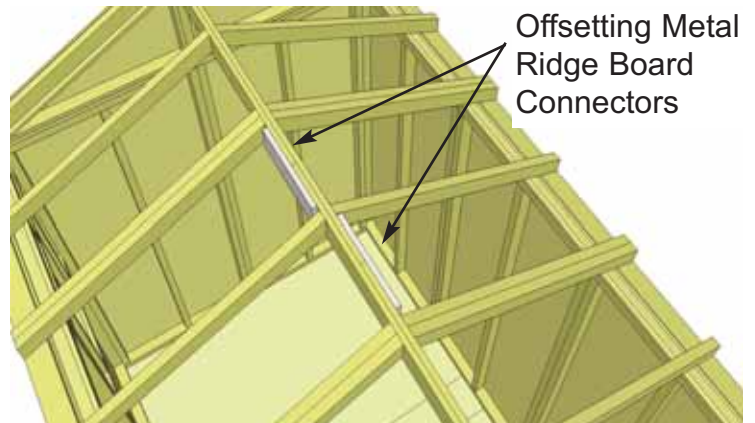
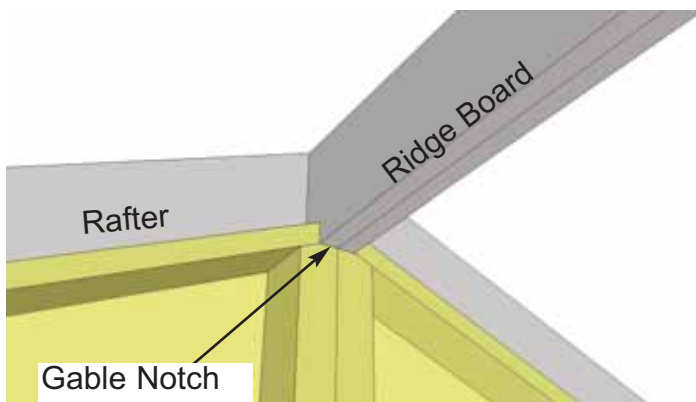

**43.** At the peak, align Ridge Boards so they are flush together and secure them with 12 - 1 1/4" screws. **Important:** if there is a gap between Ridge Boards, try pushing side walls closer together from outside. Walls should be 91" apart at top from inside of wall plate to wall plate. To completely secure Ridge Boards, place 4 - 1 1/4" screws into any of the remaining Metal Ridge Board Connector holes. Complete both sides.

**44.** With both Rafter Ridge Boards connected. Completely secure Gable framing to both outside rafters with 8 - 2" screws per gable side.

**Important:** - If Gable framing does not line up with Rafters, remove temporary 2" screws from gable framing. Re-align gable and secure with 8 - 2" screws total.

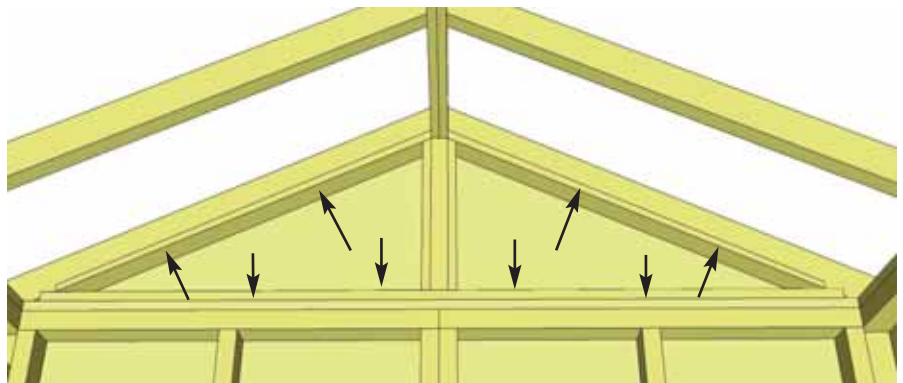

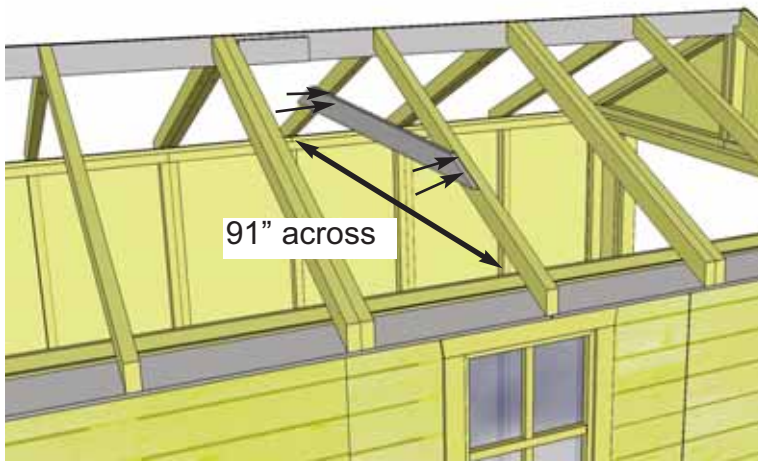

**45. Roof Gussets** are positioned on middle rafters. Prior to attaching, make sure Side Walls are properly aligned. Have two helpers push the front and rear walls at the top from the outside of shed until inside to inside measurement between Side Wall Plates is **91"**. When correct, slide gusset up, use level to square gusset and attach to rafters with 4 - 2" screws. Complete remaining Gussets.

**46. Attach all Single and Double Rafter Brackets** where rafters meet Top Wall Plates inside of shed. Attach with 2 - 1 1/4" screws and 2 - 2" screws per Single Rafter Bracket and 6 - 2" screws per Double Rafter Bracket.

Have two helpers push the Front and Rear Walls at the top from the outside of shed until inside to inside measurement between the Top Plates is 91".

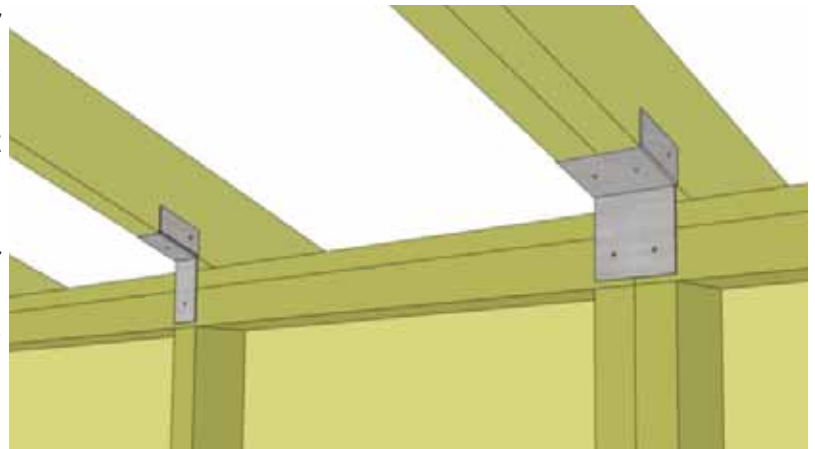

Shingles overhang plywood Roof facing down on outside panels.

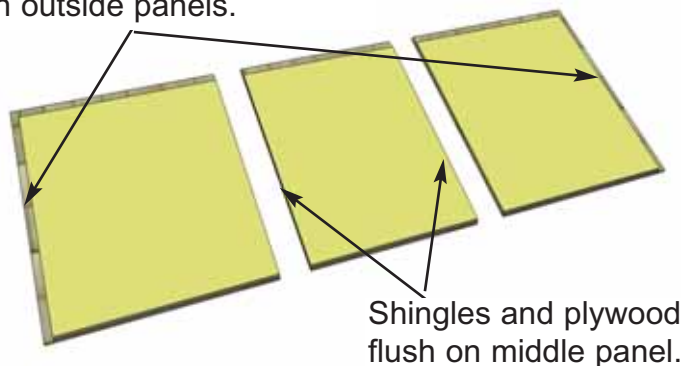

**47. Identify Roof Panels.** There are 2 Outside and 1 Middle Roof Panel per side. Starting with outside rear panel, lift up and place on rafters.

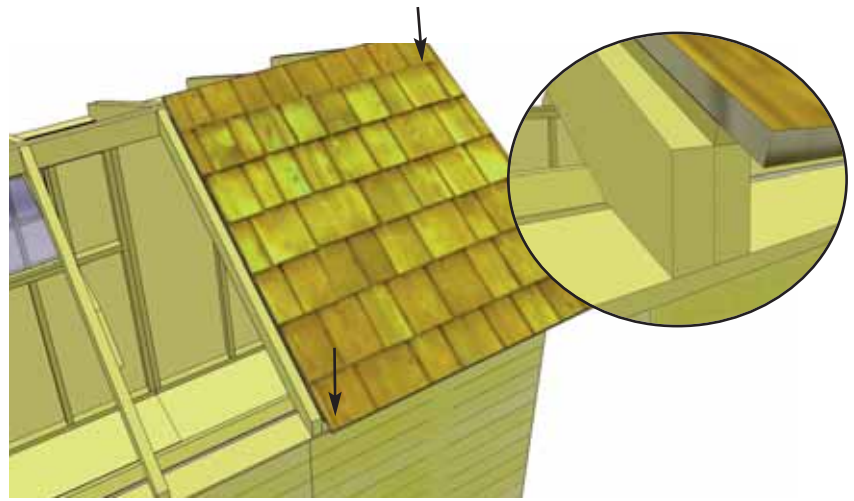
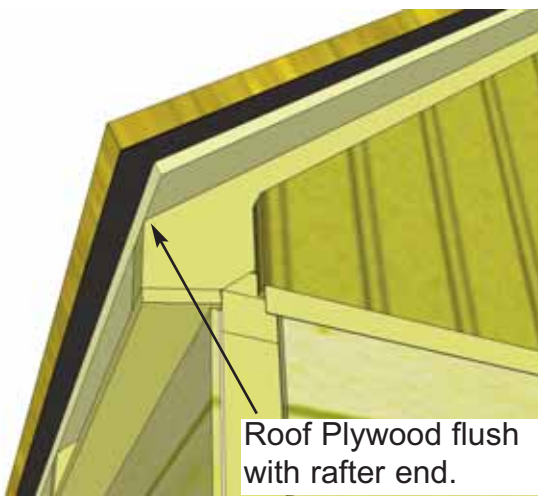

**48.** Place **Outside Roof Panel** so it sits flush on 3rd rafter from the outside (doubled up rafter). Plywood on roof should be flush with end of rafter at bottom. From the outside, screw down through bottom and top row of shingles into rafter with 2 - 2.5" screw.



**49.** Locate **Middle Roof Panel** and place on middle rafters.

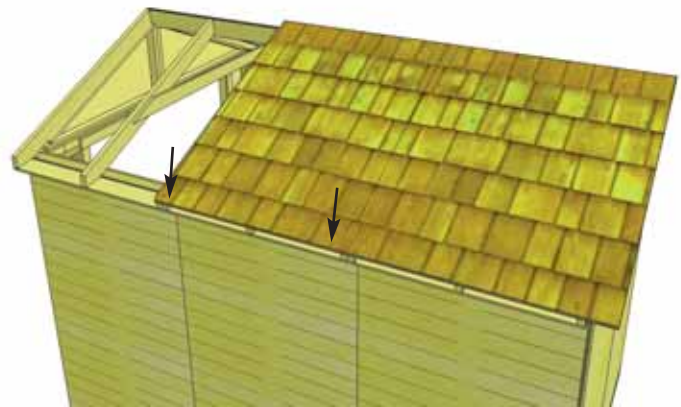

**50.** With Middle Roof Panel aligned as per **Step 48**, tack panel down to rafters with 2 - 2.5" screws in the bottom row of shingles.

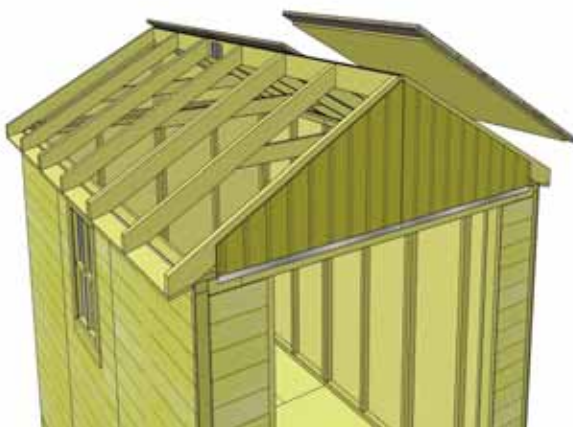

**51.** Lift up, position and attach 2nd Outside Roof Panel on Rafters as per **Step 48**.

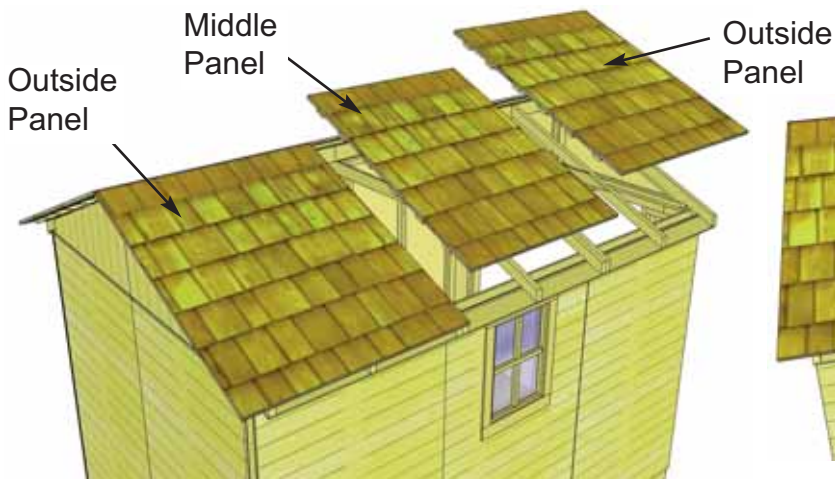

**52.** Position and attach all Roof Panels as per **Steps 48-51**.

**53.** Make sure to attach Roof Panels down to Rafters as shown above.

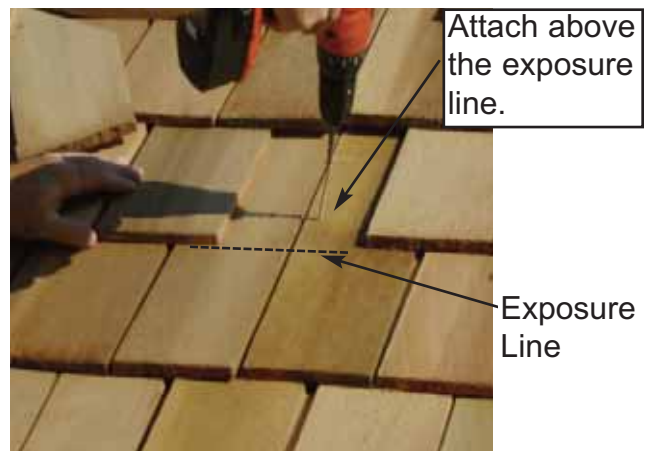

**54.** Roof **Filler Shingles** are included to cover roof seams. Starting at the bottom, slide the first Long Shingle in until flush with other bottom shingles. **See diagram step 55 for proper attachment.**

**55.** Screw first filler shingle down to rafters using 1 - 2 1/2" screw per panel (2 in total). Make sure to screw into both rafters.

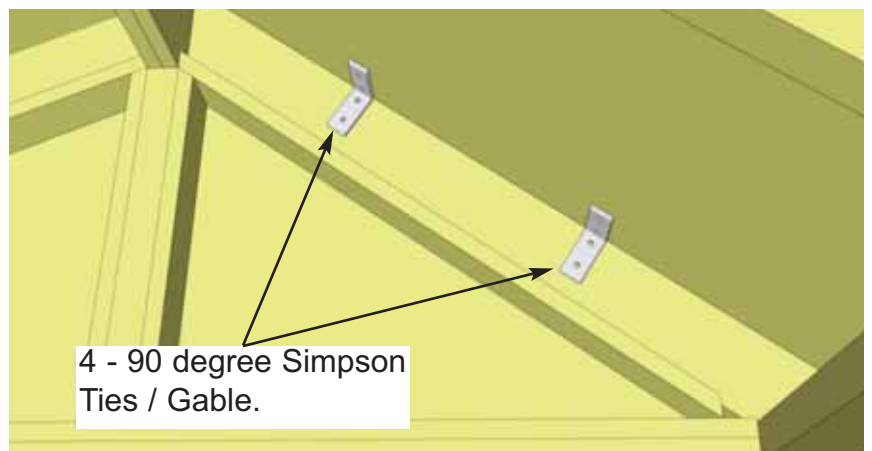

**56.** Slide in another filler shingle and attach as per **Step 55**. On your last row of shingles, the filler shingle is precut to fit properly. Attach to roof with 2 - 1 1/2" Shingle nails per shingle. Position Simpson Strong ties on plywood and outside rafters and secure with 4 - 1 1/2" screws. There are 4 ties per gable.

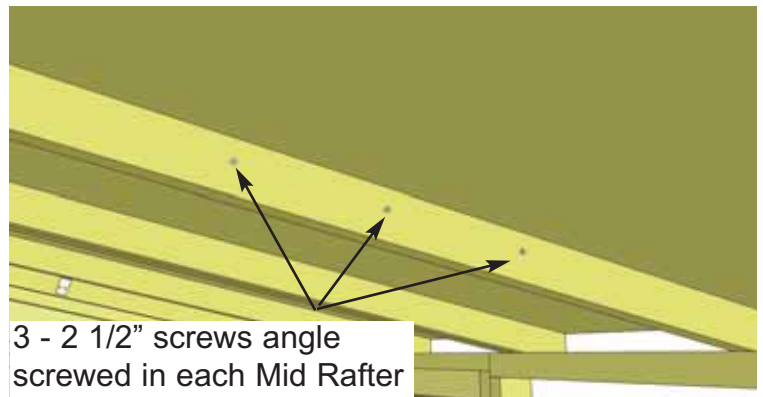
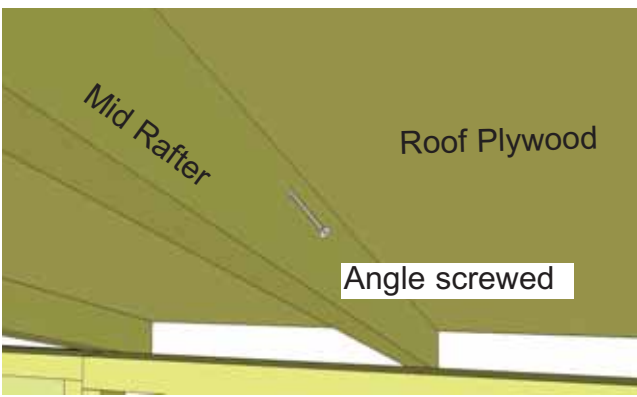

**57.** To further secure roof panels, from the inside, drill pilot holes in each Mid Rafter (3 per Rafter) on an angle. Using 3 - 2 1/2" screws, secure rafters to roof plywood. **Note:** from outside, have a helper push roof panel down so plywood sits flush against rafter when securing.

# E. Misc. Section

Exploded view of all parts necessary to complete the Miscellaneous Section. Identify all parts prior to starting.

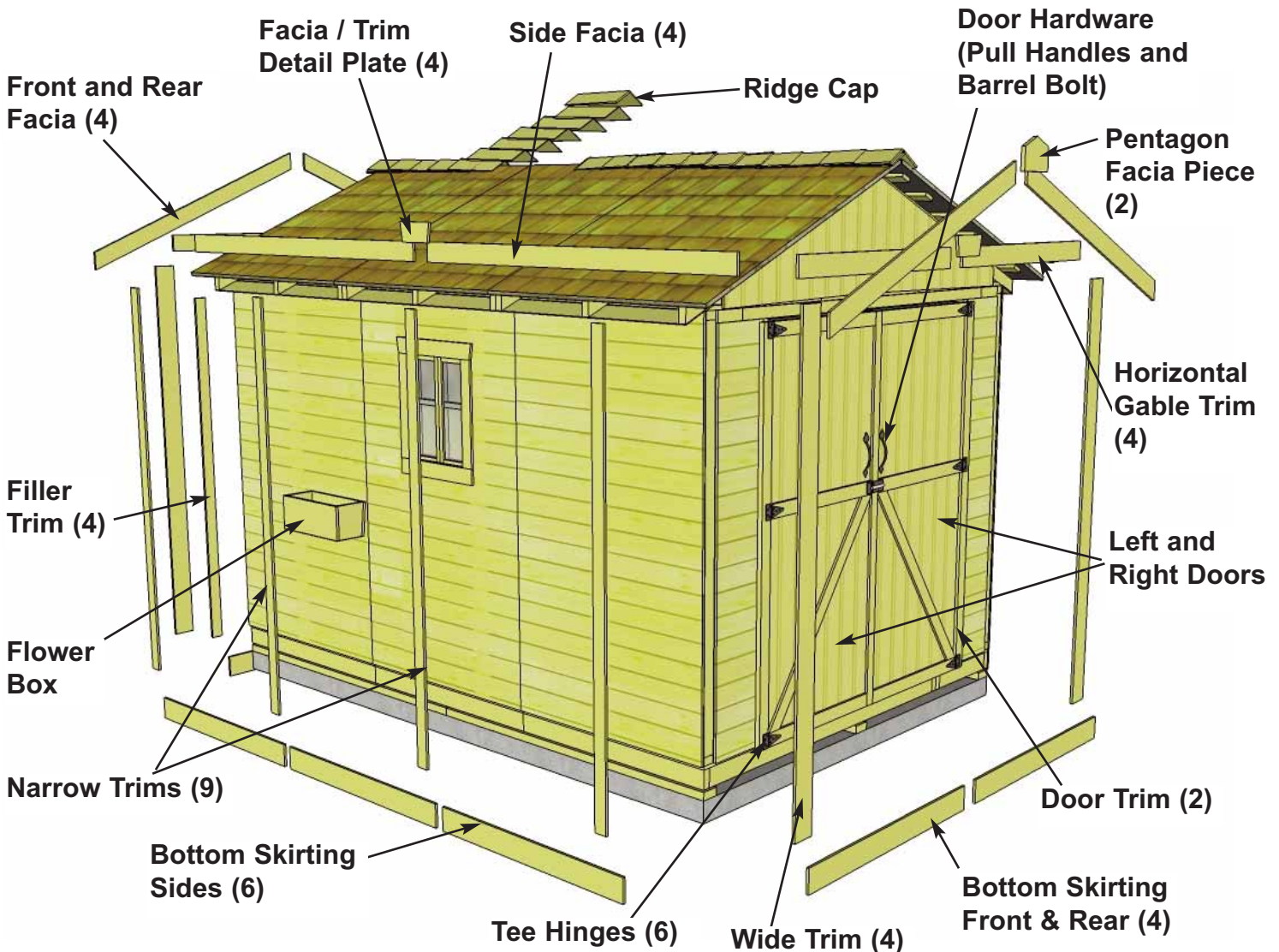

**Note:** missing from exploded drawing: Interior Door Stops and Interior Cane Bolt.



### 58. Attach **Bottom Skirting**

around the base of the shed. Skirting will hide floor framing. The front & rear skirting pieces will meet together in the center. Gaps on outside will be covered by Wide Trim pieces later. Start with side skirting and attach with 4 - 1 1/2" finishing nails per piece. Attach additional 1 1/4" screws on bottom edge of wall siding into bottom wall plate to further secure bottom siding to framing. Drill pilot holes in siding to prevent splitting.



3 pieces of Bottom Skirting for sides / 2 pieces for front and rear.

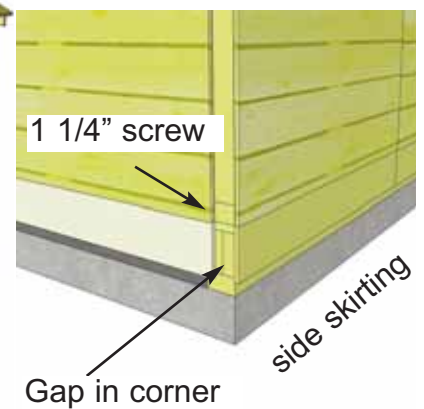

### 59. Attach **Corner Trim Filler Strips**

(4 - 1/2" x 2 1/2" x 75") to front and rear walls in each corner. Hammer with 8 - 1 1/2" finishing nails.

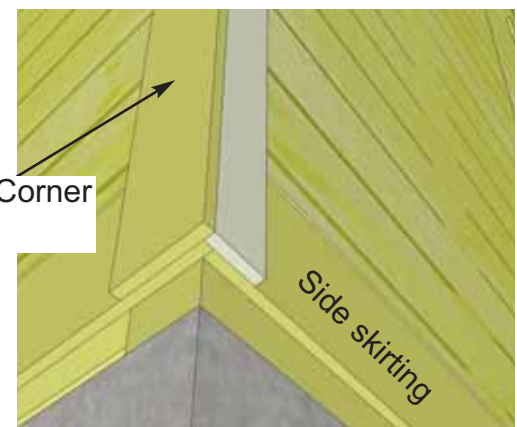
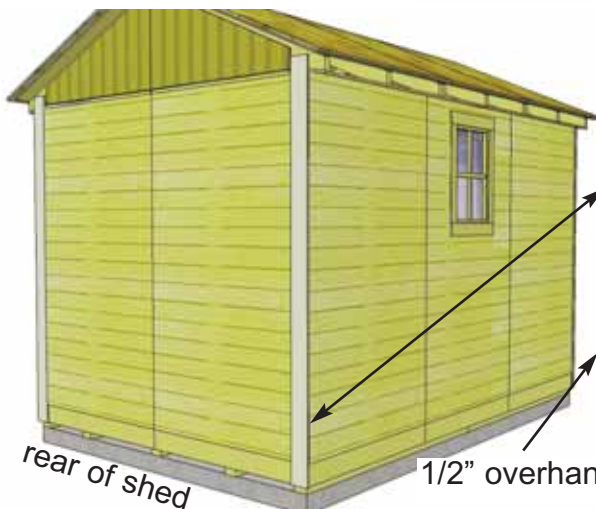
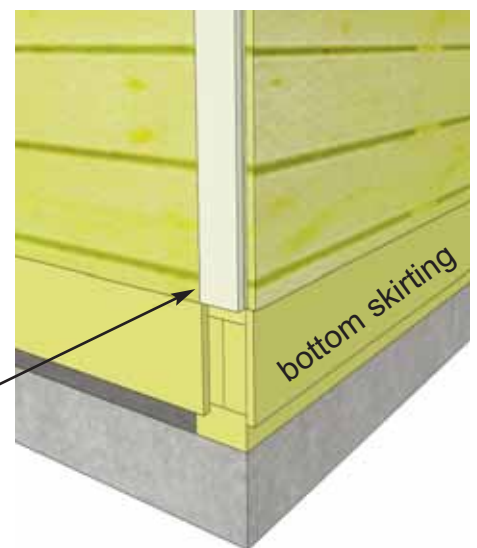

**60.** Position **Rear Wide Corner Trim** (4 - 1/2" x 4 1/2" x 82") over filler trim. Prior to attaching, do a dry run with Narrow Corner Trim - First butt Narrow Trim up tight underneath the Soffit. Position Wide Trim evenly with Narrow Trim at bottom. Attach with 8 - 1 1/2" finishing nails per piece. Wide trim will overhang sidewall by 1/2" to cap Narrow Trim. Attach **Narrow Corner Trims** to each side corner (4 - 1/2" x 2 1/2" x 79" long). Use 8 - 1 1/2" finishing nails per piece. Align Trim so tight underneath Soffit and flush with Wide Corner Trim.



**61.** Attach **Narrow Wall Trim** (4 - 1/2" x 2 1/2" x 79") where wall panels come together and leave a seam. Position trim equally on each wall and use 8 - 1 1/2" finishing nails per piece. Align as per Corner Trim . Attach **Rear Wall Trim** (77 1/2" long) as above.

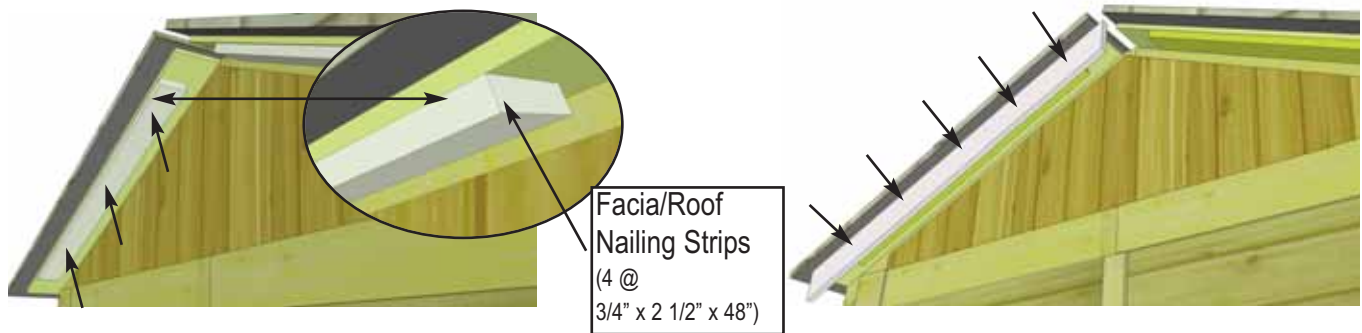

**62.** Attach **Facia/Roof Nailing Strips** (3/4" x 2 1/2" x 48") to the underside edge of the plywood roof with 3 - 1 1/4" Screws per piece. Nailing Strip will make it easier to attach Front and Rear Facia in **Step 63. Complete Front and Rear Strips (4 pieces total).**

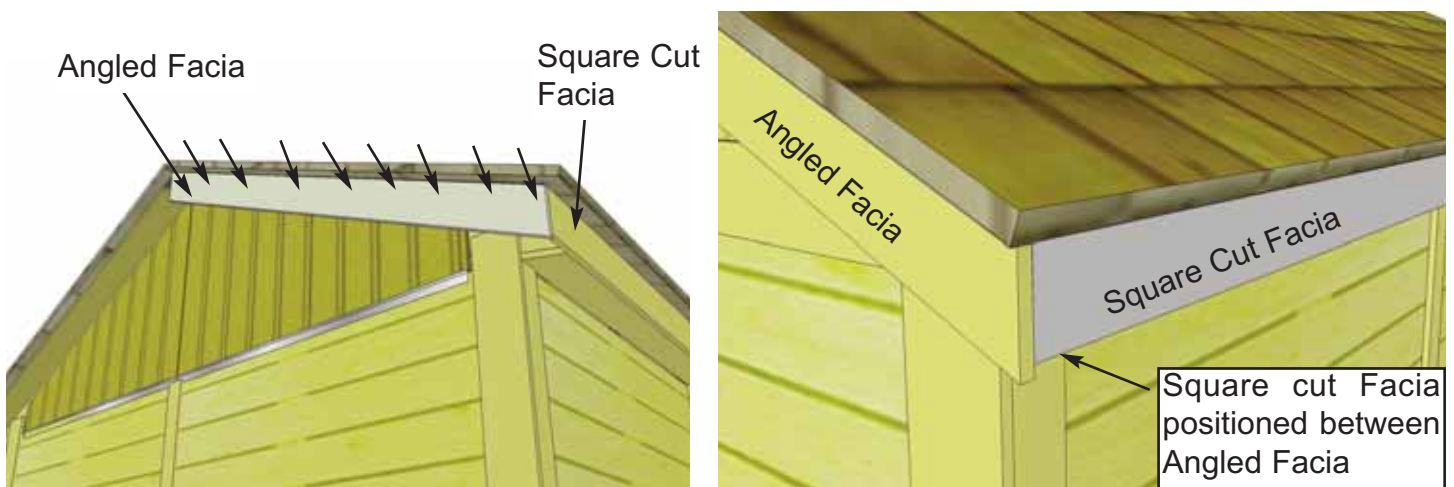

**63.** Position **Front and Rear Facia** (angle cut on ends) and Side Facia (square cut ends) in corner. Line Fascia up so square cut Facia is positioned between angled cut facia. Attach angled facia to plywood end with 8 - 1 1/2" finishing nails per piece. Gap where facia boards come together at peak will be covered in **Step 65.** Do a dry run using Fascia to help you correctly position before attaching.

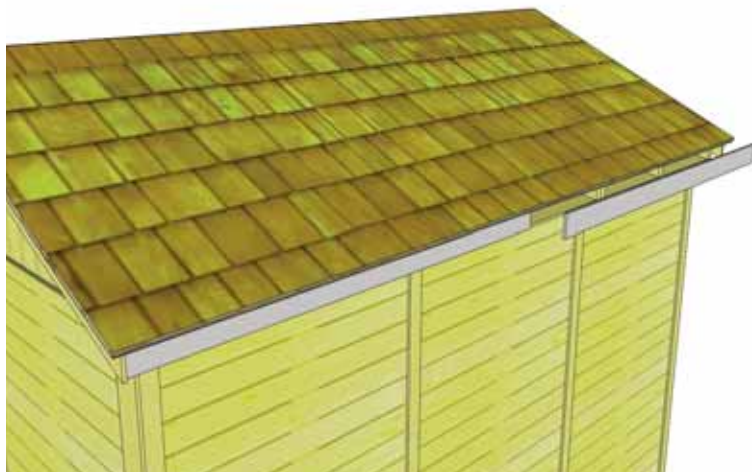

Pentagon Facia Plate

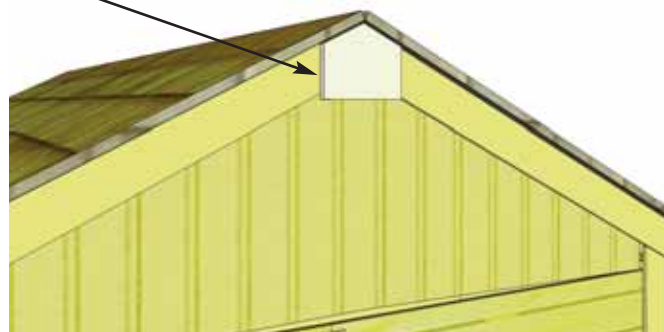

**64.** Attach **Side Facia** to roof rafter ends. There are 2 Facia pieces per side. Secure with 8 - 1 1/2" finishing nails per piece.

**65.** Attach **Pentagon Facia Plate** where End Facia meets at the peak. Use 4 - 1 1/2" finishing nails per piece to secure.

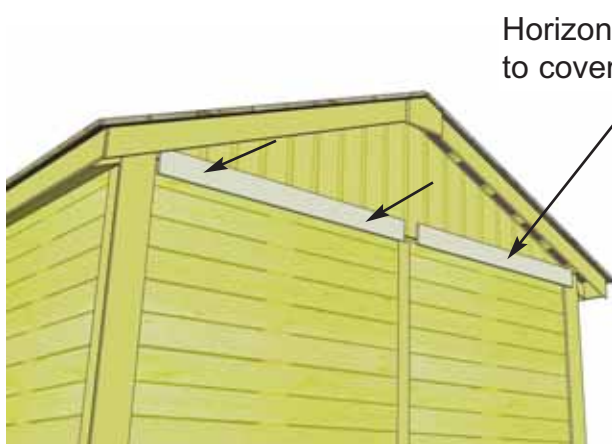

Horizontal Gable Trim to cover flashing



**66.** Attach **Horizontal Gable Trim** (4- 1/2" x 4 1/2" x 44 1/2") to both front and rear of shed. Position equally over gable and wall seam. Use 4 - 1 1/2" finishing nails per piece to secure. (2 pieces per side)

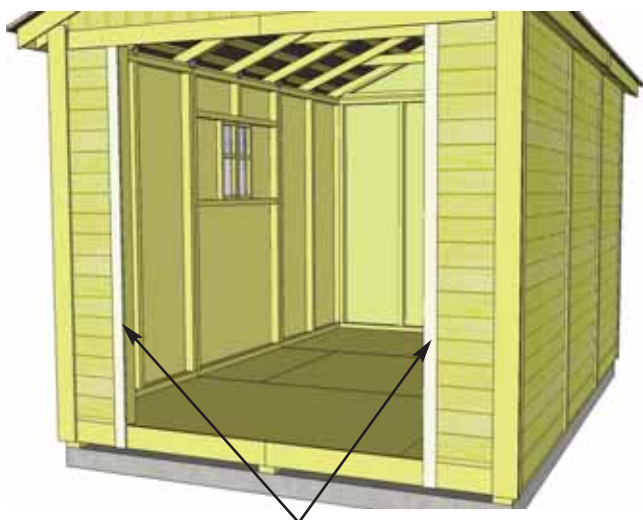

Flush with door jamb.

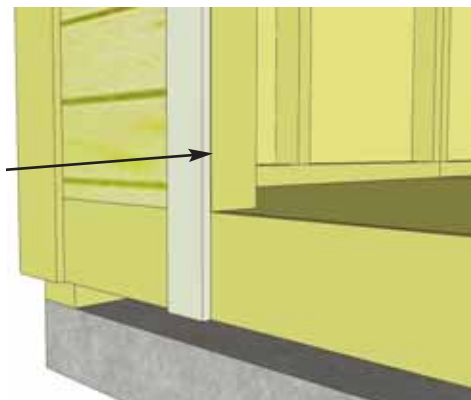

**67.** Position **Door Trim pieces** (2 - 1/2" x 2 1/2" x 77 1/2") tight at top with Horizontal Gable trim and flush with door jamb. Attach with 4 - 1 1/2" finishing nails per piece.



**68.** Attach **Facia/Trim Detail Plates** to cover seam where fascia and horizontal trim pieces come together. Secure each with 4 - 1 1/2" finishing nails

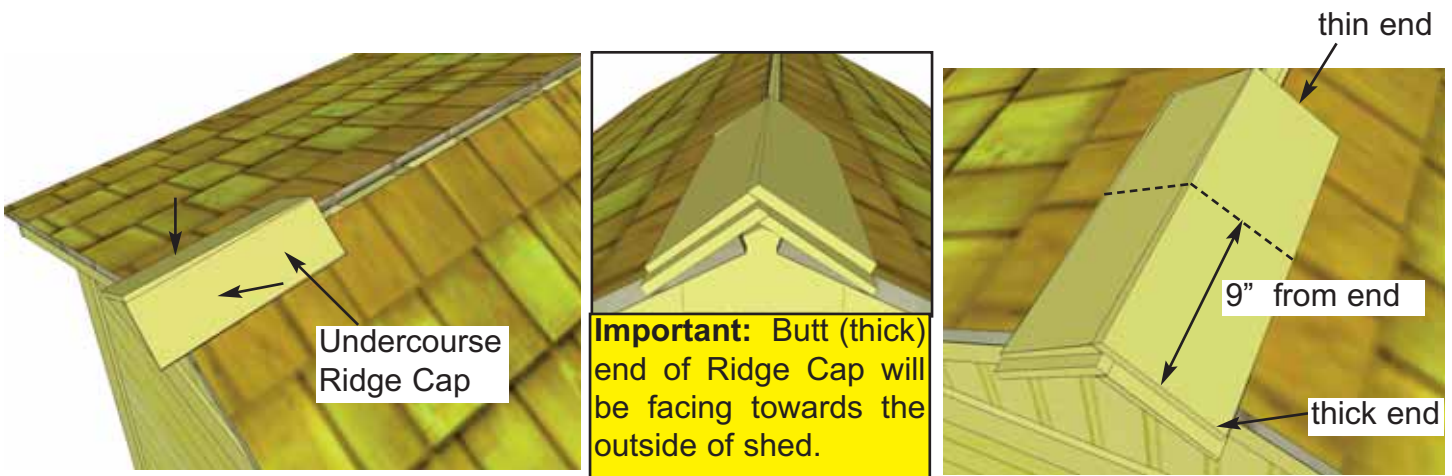

**69.** Place First Roof Ridge Cap (Lower Grade Undercourse Ridge Cap) on roof peak overhanging shingles by approximately 1". Attach with 2- 1 1/2" Shingle Nails 9" from end. Place 2nd Ridge Cap 1" back from 1st cap. Attach with 2- 1 1/2" Shingle Nails 9" from end.

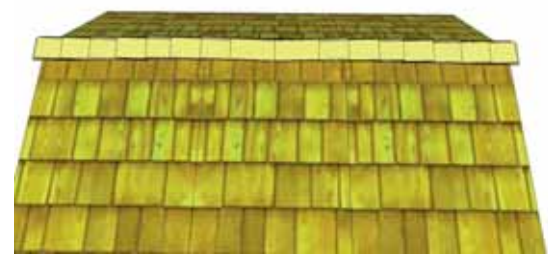
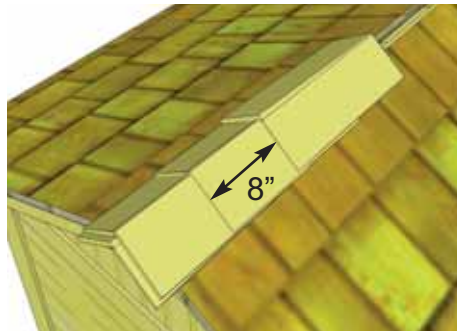
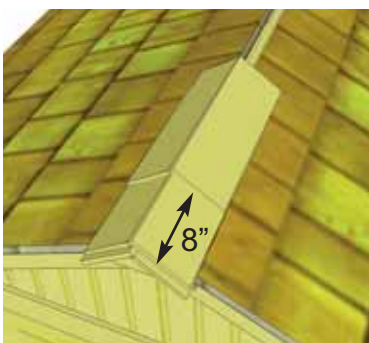

**70.** Place 3rd Ridge Cap 8" back from 2nd. (enough to cover shingle nails). Attach 3rd Ridge Cap down as per **Step 69**. Continue to position and attach Ridge Caps until half roof is complete. From opposite side, position and attach Ridge Caps as described above. Score/cut 1 Ridge Cap to 12" or to fit in the center of roof. Attach center cap with 4 - 1 1/2" Shingle Nails.

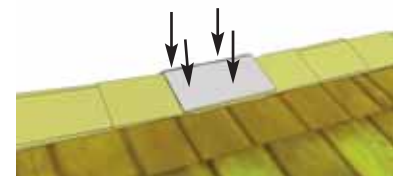

**Note:** illustration of Hinge may not be accurate. The # of screw holes in the hinge may vary from three to four depending on model.

Attach Black Tee Hinges with 3/4" & 2" Black hardware provided

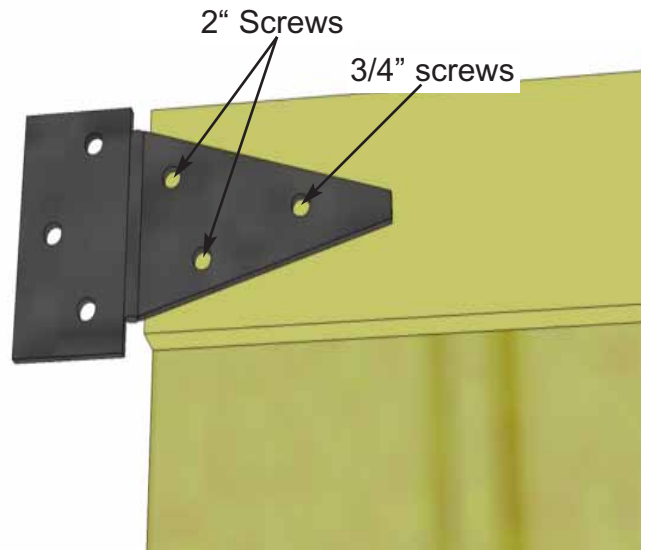

**71.** Attach Door Hinges to both **Left and Right Side Double Doors**. Position Hinges equally on door trim as shown above and attach with Black 3/4" and 2" screws.

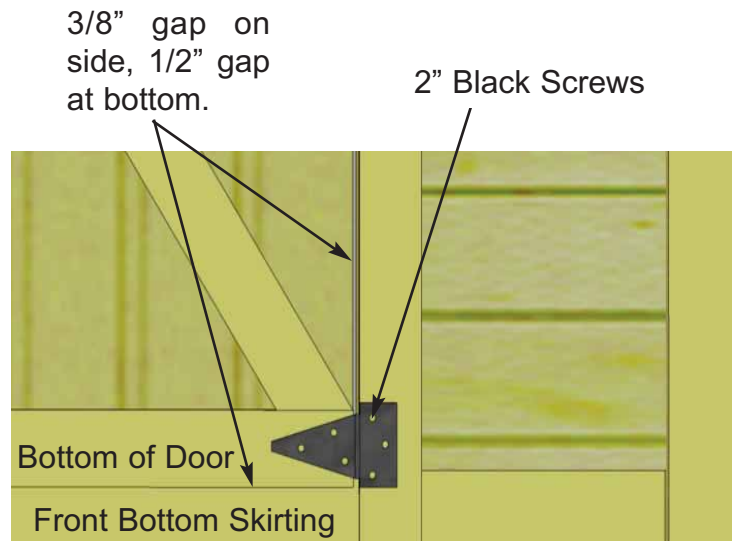

**72.** Next, position and secure the Double Doors. Starting with **Right Side Door**, position so there is a 1/2" gap on bottom and approximately 3/8" on the side. Use a spare Shingle to shim door in place at the bottom. Using 2" black screws, secure hinges to Door Trim. **Hint:** Do not attach all the 2" screws until both doors are positioned correctly into place. Use Screw Driver to tighten screws completely.



**73.** Position **Left Side Door** as per **Step 72** and secure with 2" Black Screws. When satisfied with door positioning, complete all 2" screws. **Note:** Do not over tighten hinge screws when using screw gun. Tighten 3/4 of the way and use a Screw Driver to finish so as not to strip screws.

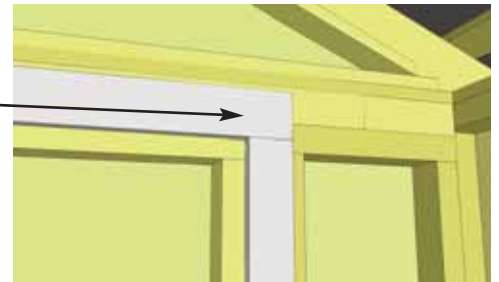

**74.** Attach Horizontal and Vertical **Door Stops** to door header and jambs. Start with horizontal Stop first and then complete both vertical stops. Position so door gap is covered. Use 4 - 2" screws per piece to secure.

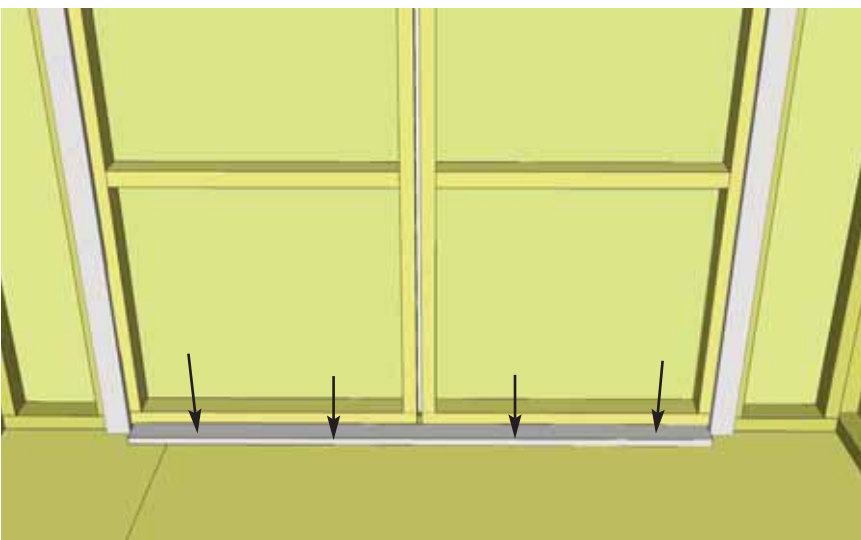

**75.** Close both doors and align so doors are straight. Attach Door Threshold (2 1/2" wide x 62 1/2" long) with 4 - 2" screws, centering between doorway.

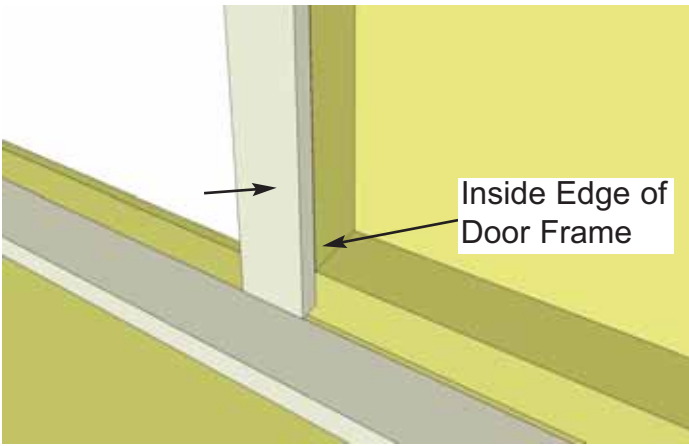

**76.** Position and attach **Vertical Door Flange** on inside door frame (**left door from outside**) using 6 - 2" screws. Position on inside edge of door frame.

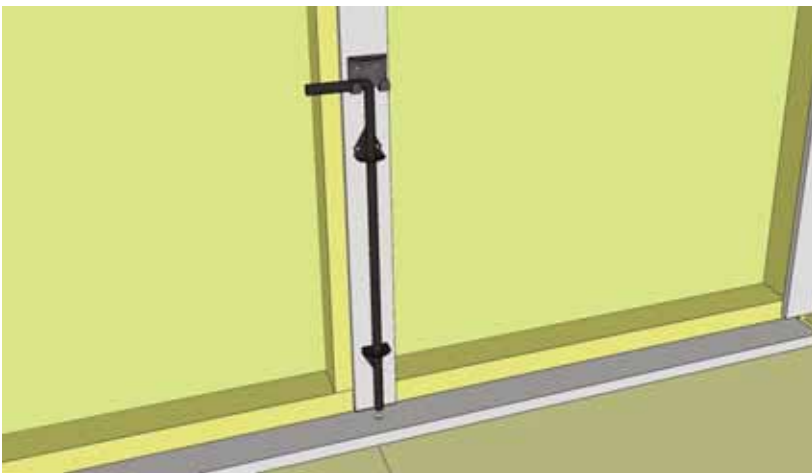

Drill 1/2" Diameter Hole to accommodate rod of Cane Bolt.

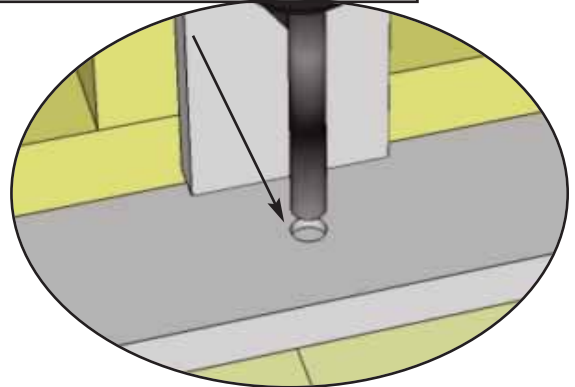

**77.** The **Interior Cane Bolt** will be attached to Vertical Door Flange. To position Cane Bolt correctly, attach to flange first, close doors and mark hole to house Cane Bolt Rod. Open doors and drill hole where previously marked with 1/2" bit. Attach Cane Bolt with 3/4" black screws.



**78.** Attach Door Handles and Black Barrel Bolt as illustrated above with 3/4" Black Screws. Note how female part of Barrel Bolt is positioned higher than male. Do a dry run first to position Barrel Bolt correctly. **Important:** Drill pilot holes with 1/8" drill bit prior to securing with screws to prevent wood splitting.



**79.** Assemble **Flower Box Kit** with Assembly Instructions included. Position completed Flower Box below bottom of window trim and secure with 2 - 2" screws per box. Screw from inside of box into the center wall stud. Attach second screw 2" underneath first screw and once again into the wall stud.

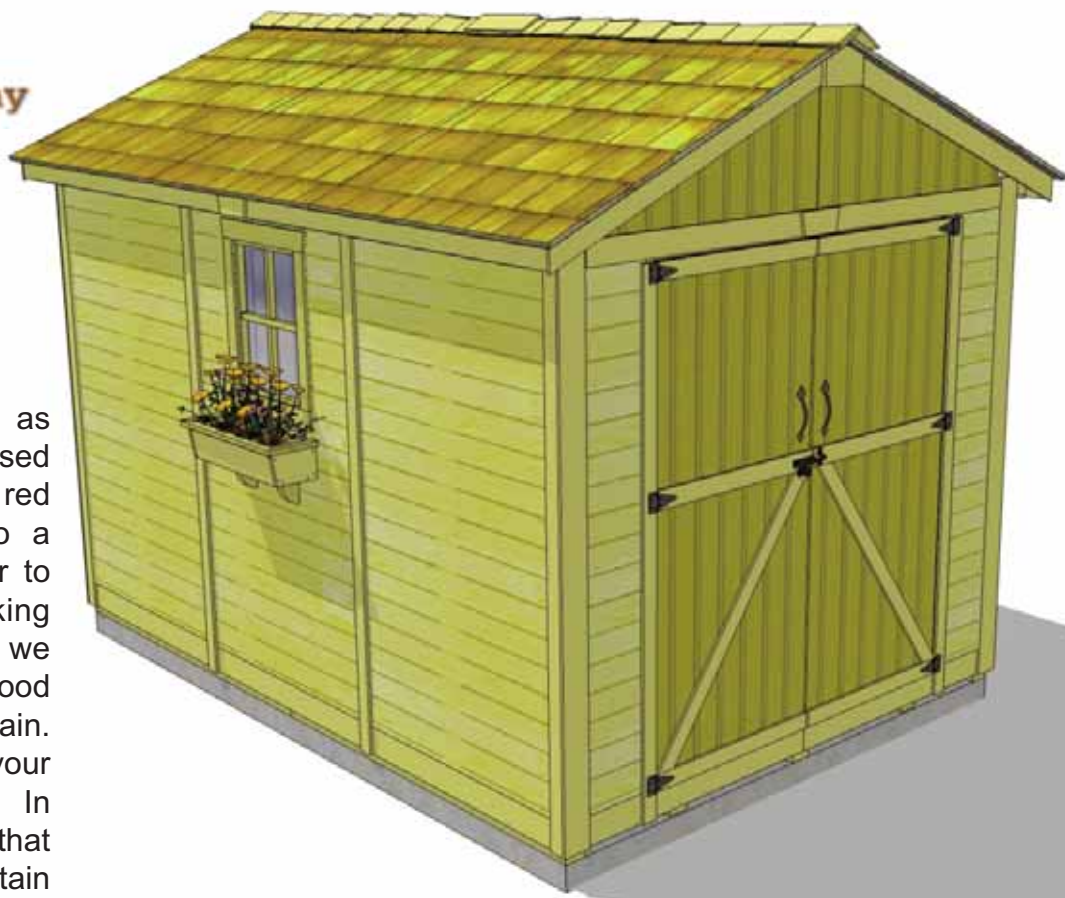

**Note:** Our Sheds are shipped as an unfinished products. If exposed to the elements, the western red cedar lumber will weather to a silvery-gray color. If you prefer to keep the cedar lumber looking closer to the original color, we suggest that you treat the wood with a good oil base wood stain. You may also wish to paint your new shed rather than stain it. In both cases we recommend that you consult with a paint and stain dealer in your area for their recommendations.

We hope your experience assembling your shed has been both positive and rewarding.

We value your feedback and would like to hear back from you on how well we are doing in the following areas:

1. Customer Service
2. On Time Shipping
3. Motor Freight Delivery
4. Quality of Materials
5. Assembly Manual
6. Overall Satisfaction.

Please call, write or email us at:

Canadian Address  
9393 287th Street  
Maple Ridge, British Columbia  
Canada V2W 1L1

United States Address  
P.O. Box 96  
Sumas, Washington  
USA 98295



The materials contained in this Assembly Manual may be downloaded or copied provided that ALL copies retain the copyright and any other proprietary notices contained on the materials. No material may be modified, edited or taken out of context such that its use creates a false or misleading statement or impression as to the positions, statements or actions.