

What's in This Section

2-Panel, 4-Panel, and Stationary Page 5

Parts Illustration 5

 Parts Illustration - 4-Panel 5

 Parts Illustration - 2-Panel 6

Unit Sizes 7

 Unit Size Chart - 6' 8" Height 7

 Unit Size Chart - 6' 11" Height 8

 Unit Size Chart - 8' 0" Height 9

Panels - Operating 10

 Illustration Operating Panels 10

 Size Table - Operating 11

 Operating Panels 11

 Reachout Lock Astragal - Operating - 4-Panel 17

 Glazing Stops - Operating 19

 Interlock - Set 20

 Panel Parts - Operating 21

Panels - Stationary 23

 Illustration Stationary Panels 23

 Size Table - Stationary Panels 24

 Stationary Panels 24

 Glazing Stops - Stationary 29

 Interlock - Set 30

 Panel Parts - Stationary 31

Insect Screens 32

 Illustration Screen - 2 & 4 Panel - Current 32

 Illustration Screen - 2 & 4 Panel - Vintage 33

 Rescreening Kits - Gliding Insect Screen 34

 Gliding Insect Screen Hardware/ 2 Panel/ Current 35

 Gliding Insect Screen Hardware/ 2 Panel/ Vintage 37

 Gliding Insect Screen Hardware/ 4 Panel Door 38

 Retractable Insect Screens/ Current 39

 Retractable Insect Screen Parts/ Current 39

 Retractable Insect Screen/ Vintage 46

Grilles 50

 Interior Grilles - Colonial 50

 Grille Fastener 53

Hardware 54

Half Trim Set Kits - Interior	54
Half Trim Set Kits - Exterior	56
Hardware - Tribeca®	57
Hardware - Anvers®	60
Hardware - Newbury®	63
Hardware - Covington™	67
Hardware - Whitmore®	70
Hardware - Encino®	74
Hardware - Yuma®	77
Hardware - Albany	80
Shared Trim Set Parts / Current	84
Lock Parts / Current	85
Lock Parts / Vintage	88
Vintage Trim Set Parts	91
Screw Packages - Frame	92
Fasteners	94
Frames	97
Jambs	98
Frame Parts	101
Stops	102
Head Flashing	104
Installation Flanges	104
Weatherstrip	106
Sills	107
Filler	109
Frame Parts and Hardware	110
Extension Jambs	112
Sill Ramp Parts	115
Fasteners	116
Joining Components	117
Joining Components - Narrow Mullion	117
Joining Components - LVL* Reinforced	118
Joining Components - Support Mullion	120
Universal Drip Cap - Continuous	121
Art Glass Components	122
Trim Stops - Art Glass	122
Art Glass Hardware	122
Stormwatch® Protection (Coastal Product)	Page 123
Service Replacement	Page 125
Service Replacement Only Parts	125
Insect Screen Guide - Predrilled / Aluminum	125

Stops with Screws - Head Parting / Predrilled	125
Head Panel Spacers	126
Exterior Grilles - HDN	126
Miscellaneous Hardware Parts	127
Panel Snugger	127
Cartons	127
Panels - Operating / Stormwatch®	128
Operating Panel Parts/ Stormwatch®	131
Panels - Stationary / Stormwatch®	132
Stationary Panel Parts/ Stormwatch®	135
Screw Package - Frame (Impact Resistant) / Stormwatch®	135
Jamb (Impact Resistant) / Stormwatch®	136
Impact Resistant Complete Sills / Stormwatch®	139

Frenchwood® Gliding Doors (1987 to Present)

2-Panel, 4-Panel, and Stationary

Parts Illustration

Parts Illustration - 4-Panel

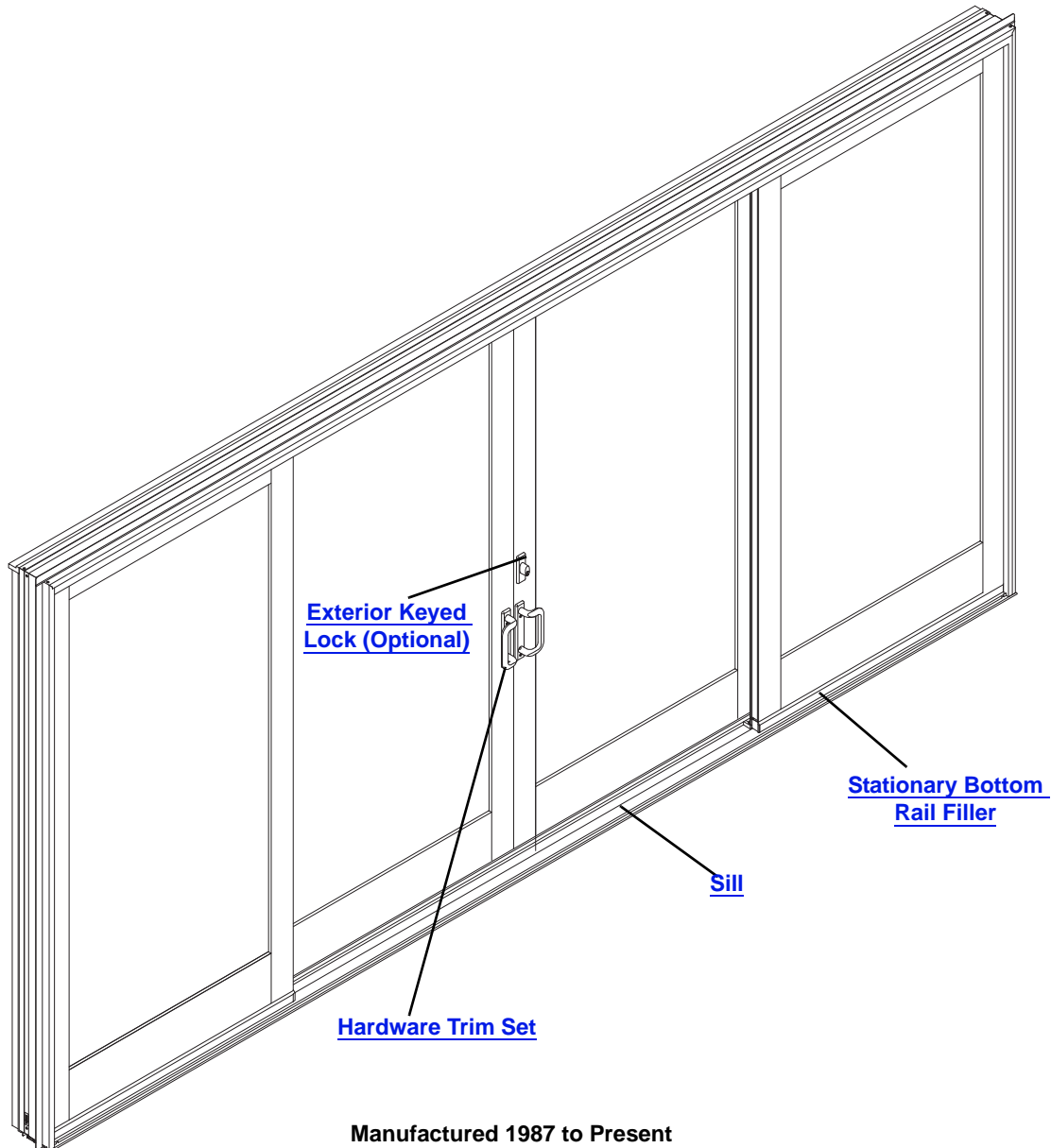

Frenchwood® Gliding Unit Parts - 4-Panel

Unit viewed from exterior.

Parts Illustration

Parts Illustration - 2-Panel

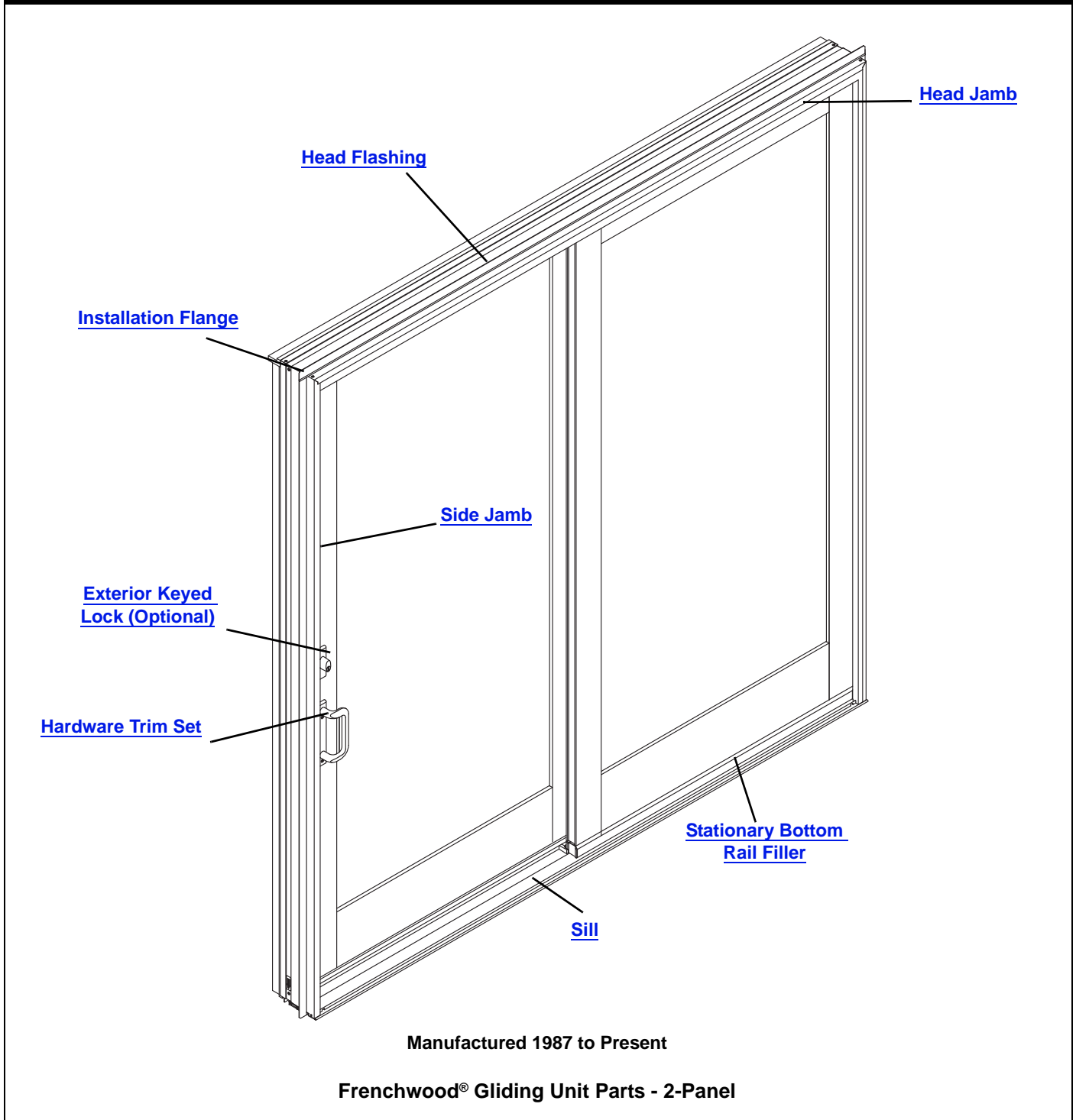

Unit viewed from exterior.

Frenchwood® Gliding Doors (1987 to Present)

2-Panel, 4-Panel, and Stationary

Unit Sizes

Unit Size Chart - 6' 8" Height

Note:

Unit Dimension refers to overall outside-to-outside frame. Unobstructed Glass refers to visible glass dimensions. Numbers in parentheses are metric measurements.

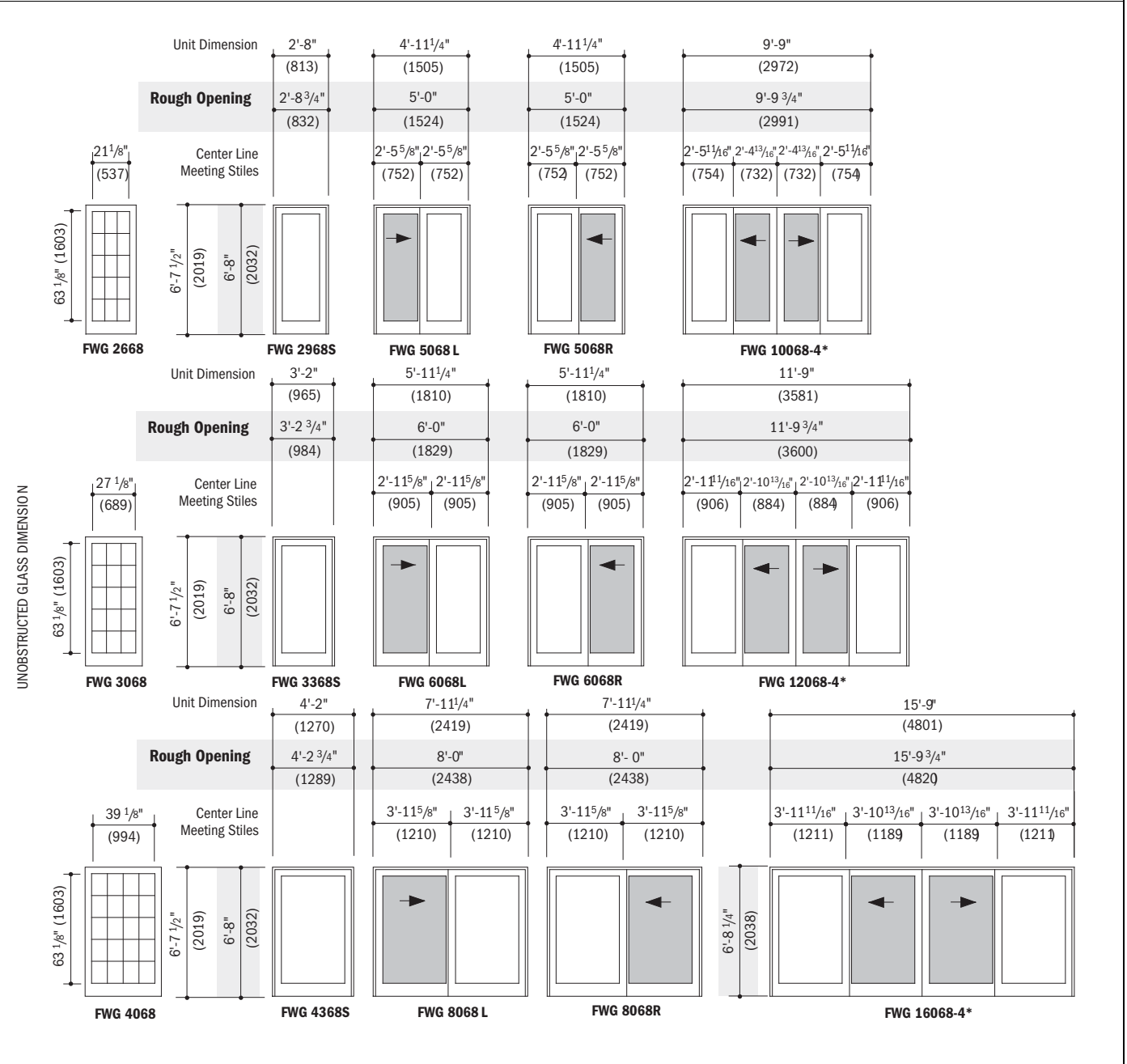

Manufactured 1987 to Present

Frenchwood® Gliding Unit Sizes - 6' 8" Height

Unit viewed from exterior.

Unit Sizes

Unit Size Chart - 6' 11" Height

Note:

Unit Dimension refers to overall outside-to-outside frame. Unobstructed Glass refers to visible glass dimensions. Numbers in parentheses are metric measurements.

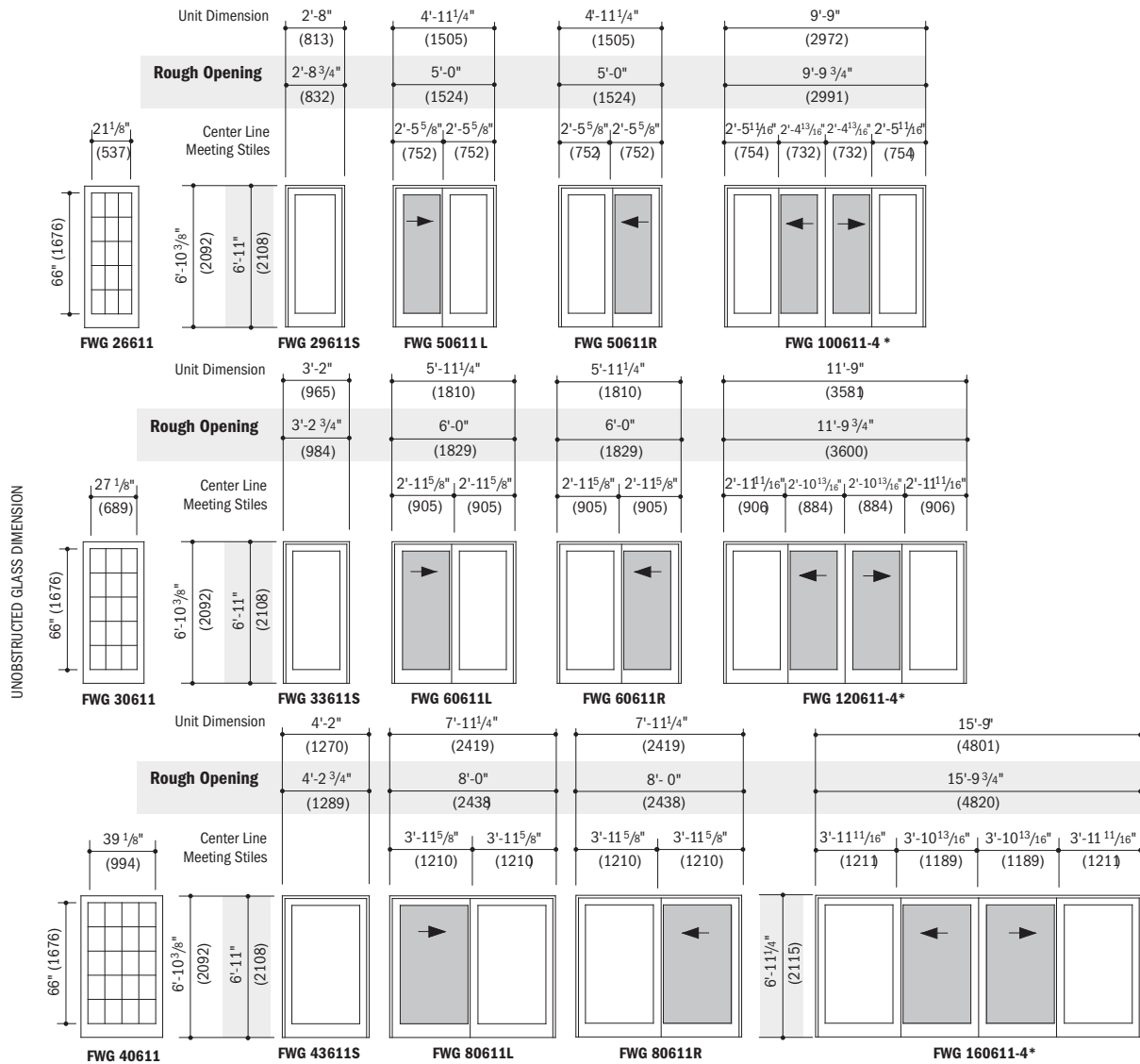

Manufactured 1995 to Present

Frenchwood® Gliding Unit Sizes - 6' 11" Height

Unit viewed from exterior.

Frenchwood® Gliding Doors (1987 to Present)

2-Panel, 4-Panel, and Stationary

Unit Sizes

Unit Size Chart - 8' 0" Height

Note:

Unit Dimension refers to overall outside-to-outside frame. Unobstructed Glass refers to visible glass dimensions. Numbers in parentheses are metric measurements.

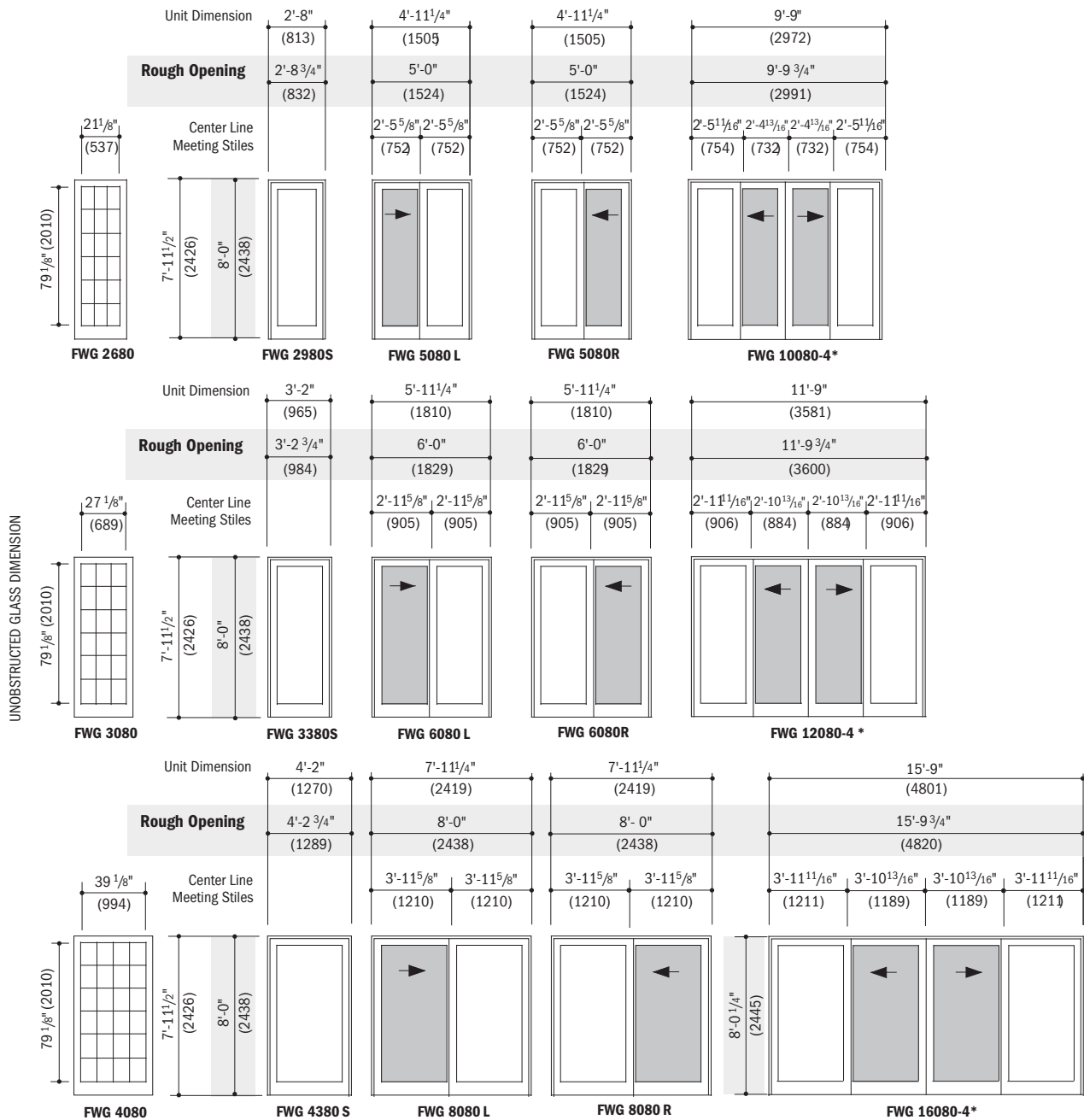

Manufactured 1994 to Present

Frenchwood® Gliding Unit Sizes - 8' 0" Height

Unit viewed from exterior.

Panels - Operating

Illustration Operating Panels

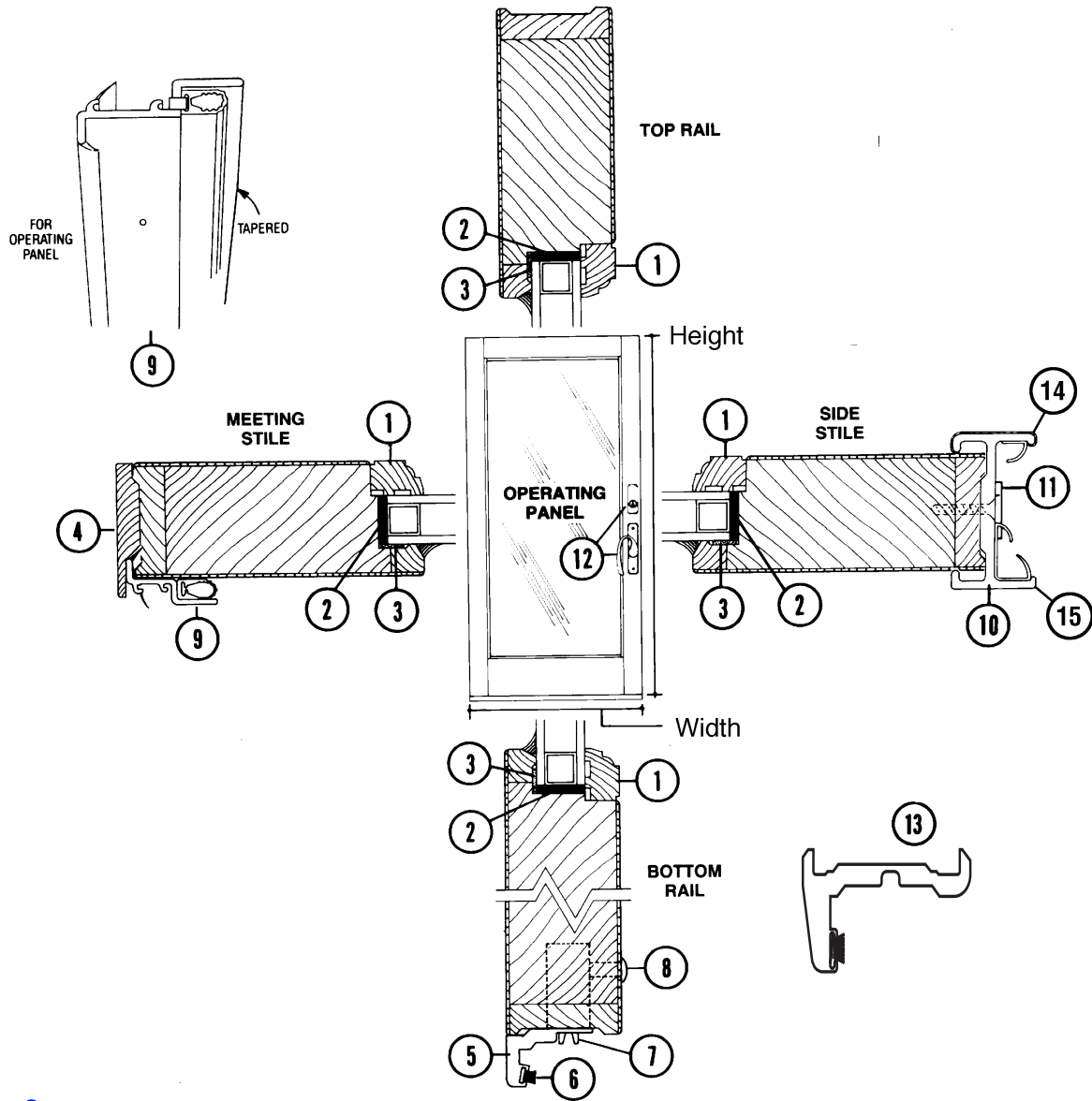

- | | |
|---|---|
| <ul style="list-style-type: none"> 1. Glazing Stop 2. Glass Spacers 3. Silicone Glazing 4. Trim Piece Operating Meeting Stile 5. Operating Bottom Rail Filler with Screws - 68/611 Height 6. Operating Bottom Rail Filler Finseal Pile W/S 7. Tandem Roller 8. Plugs, Adjusting Holes | <ul style="list-style-type: none"> 9. Interlock W/S, Meeting Stile - Set 10. 4-panel Door Astragal 11. Lock Strike Plate with Liner 12. Hardware Trim Set 13. Operating Bottom Rail Filler with Screws - 80 Height and DP Upgrade 14. Inside Astragal Weatherstrip 15. Outside Astragal Weatherstrip |
|---|---|

Frenchwood® Gliding Operating Panel - 4-Panel

Unit viewed from exterior.

Frenchwood® Gliding Doors (1987 to Present)

2-Panel, 4-Panel, and Stationary

Panels - Operating

Size Table - Operating

Note:

Operating Panel is measured outside edge to outside edge of frame.

Unobstructed *Glass* is dimension from outside edge to outside edge of visible glass only.

Actual Glass is dimension of outside edge to outside edge of glass, including glass that is not visible.

1" Finelight™ grille profile is standard, with color matching exterior color of panel. Maple and Oak finishes introduced in 1999. Pre-finished white introduced in 2000.

Unit No.	Operating Panel	Unobstructed Glass	Actual Glass
FWG2668	30 × 76 ⁹ / ₆₄	21 ¹ / ₈ × 63 ¹ / ₈	22 ¹ / ₄ × 64 ¹ / ₄
FWG26611	30 × 79 ¹ / ₆₄	21 ¹ / ₈ × 66	22 ¹ / ₄ × 67 ¹ / ₈
FWG2680	30 × 92 ⁹ / ₆₄	21 ¹ / ₈ × 79 ¹ / ₈	22 ¹ / ₄ × 80 ¹ / ₄
FWG3068	36 × 76 ⁹ / ₆₄	27 ¹ / ₈ × 63 ¹ / ₈	28 ¹ / ₄ × 64 ¹ / ₄
FWG30611	36 × 79 ¹ / ₆₄	27 ¹ / ₈ × 66	28 ¹ / ₄ × 67 ¹ / ₈
FWG3080	36 × 92 ⁹ / ₆₄	27 ¹ / ₈ × 79 ¹ / ₈	28 ¹ / ₄ × 80 ¹ / ₄
FWG4068	48 × 76 ⁹ / ₆₄	39 ¹ / ₈ × 63 ¹ / ₈	40 ¹ / ₄ × 64 ¹ / ₄
FWG40611	48 × 79 ¹ / ₆₄	39 ¹ / ₈ × 66	40 ¹ / ₄ × 67 ¹ / ₈
FWG4080	48 × 92 ⁹ / ₆₄	39 ¹ / ₈ × 79 ¹ / ₈	40 ¹ / ₄ × 80 ¹ / ₄

Operating Panels

Note:

Operating panels for custom sized doors are made to order. Product ID label is located on top edge of operating panel.

To order, state:

1. Description of part (Operating Panel)
2. Handing (RH or LH)
3. Quantity
4. Product ID
5. Options Desired (if different than original product)

Panels - Operating

Panel - Operating / High-Performance Tempered / Pine Interior					
	Unit No.	Pine Interior/ White Exterior	Pine Interior/ Terratone® Exterior	Pine Interior/ Sandtone Exterior	Pine Interior/ Forest Green Exterior
	FWG2668	2565904	2651004	0911002	1262340
	FWG26611	2565902	2651002	0911003	1262138
	FWG2680	2565924	2651024	0911022	1262140
	FWG3068	2565908	2651008	0911006	1262144
	FWG30611	2565917	2651017	0911015	1262146
	FWG3080	2565928	2651028	0911026	1262148
	FWG4068	2565912	2651012	0911010	1262150
	FWG40611	2565919	2651019	0911017	1262152
	FWG4080	2565932	2651032	0911030	1262154

Frenchwood® Gliding Doors (1987 to Present)

2-Panel, 4-Panel, and Stationary

Panels - Operating

Panel - Operating / High-Performance Tempered / Maple Interior					
	Unit No.	Maple Interior/ White Exterior	Maple Interior/ Terratone® Exterior	Maple Interior/ Sandtone Exterior	Maple Interior/ Forest Green Exterior
	FWG2668	2566237	2651069	0910973	1262156
	FWG26611	2566235	2651077	0910974	1262158
	FWG2680	2566249	2651083	0910987	1262160
	FWG3068	2566239	2651073	0910977	1262162
	FWG30611	2566245	2651079	0910983	1262164
	FWG3080	2566251	2651085	0910989	1262166
	FWG4068	2566241	2651075	0910979	1262168
	FWG40611	2566247	2651081	0910985	1262170
	FWG4080	2566253	2651087	0910991	1262172

Panel - Operating / High-Performance Tempered / Oak Interior					
	Unit No.	Oak Interior/ White Exterior	Oak Interior/ Terratone® Exterior	Oak Interior/ Sandtone Exterior	Oak Interior/ Forest Green Exterior
	FWG2668	2566217	2651049	0910947	1262174
	FWG26611	2566215	2651057	0910948	1262176
	FWG2680	2566229	2651063	0910961	1262178
	FWG3068	2566219	2651053	0910951	1262180
	FWG30611	2566225	2651059	0910957	1262182
	FWG3080	2566231	2651065	0910963	1262184
	FWG4068	2566221	2651055	0910953	1262186
	FWG40611	2566227	2651061	0910959	1262188
	FWG4080	2566233	2651067	0910965	1262190

Panel - Operating / High-Performance Tempered / Prefinished Interior White		
	Unit No.	Prefinished Interior White/ White Exterior
	FWG2668	2566201
	FWG26611	2566257
	FWG2680	2566259
	FWG3068	2566263
	FWG30611	2566261
	FWG3080	2566265
	FWG4068	2566269
	FWG40611	2566267
	FWG4080	2566271

Panels - Operating

Panel - Operating / High-Performance Tempered / Smart Sun / Pine Interior				
	Unit No.	White Exterior	Terratone® Exterior	Sandtone Exterior
	FWG2668	By description	By description	By description
	FWG26611	By description	By description	By description
	FWG2680	By description	By description	By description
	FWG3068	9021468	9021401	9021400
	FWG30611	By description	By description	By description
	FWG3080	By description	By description	By description
	FWG4068	9021470	9021405	9021404
	FWG40611	By description	By description	By description
	FWG4080	By description	By description	By description

Panel - Operating / High-Performance Sun 3 Tempered / Pine Interior				
	Unit No.	Pine Interior/ White Exterior	Pine Interior/ Terratone® Exterior	Pine Interior/ Sandtone Exterior
	FWG2668	2566004	2651204	0911102
	FWG26611	2566002	2651202	0911103
	FWG2680	2566034	2651224	0911122
	FWG3068	2566018	2651208	0911106
	FWG30611	2566027	2651217	0911115
	FWG3080	2566038	2651228	0911126
	FWG4068	2566022	2651212	0911110
	FWG40611	2566029	2651219	0911117
	FWG4080	2566042	2651232	0911130

Panel - Operating / High-Performance Sun 3 Tempered / Maple Interior				
	Unit No.	Maple Interior/ White Exterior	Maple Interior/ Terratone® Exterior	Maple Interior/ Sandtone Exterior
	FWG2668	2566067	2651280	0911141
	FWG26611	2566065	2651261	0911142
	FWG2680	2566079	2651274	0911155
	FWG3068	2566069	2651264	0911145
	FWG30611	2566075	2651270	0911151
	FWG3080	2566081	2651276	0911157
	FWG4068	2566071	2651266	0911147
	FWG40611	2566077	2651272	0911153
	FWG4080	2566083	2651278	0911159

Frenchwood® Gliding Doors (1987 to Present)

2-Panel, 4-Panel, and Stationary

Panels - Operating

Panel - Operating / High-Performance Sun 3 Tempered / Oak Interior				
	Unit No.	Oak Interior/ White Exterior	Oak Interior/ Terratone® Exterior	Oak Interior/ Sandtone Exterior
	FWG2668	2566047	2651254	0911101
	FWG26611	2566045	2651235	0911107
	FWG2680	2566059	2651248	0911135
	FWG3068	2566049	2651238	0911119
	FWG30611	2566055	2651244	0911129
	FWG3080	2566061	2651250	0911137
	FWG4068	2566051	2651240	0911121
	FWG40611	2566057	2651246	0911133
	FWG4080	2566063	2651252	0911139

Panel - Operating / High-Performance Sun 3 Tempered / Prefinished Interior White		
	Unit No.	Prefinished Interior White/ White Exterior
	FWG2668	2566291
	FWG26611	2566293
	FWG2680	2566295
	FWG3068	2566299
	FWG30611	2566297
	FWG3080	2566302
	FWG4068	2566306
	FWG40611	2566304
	FWG4080	2566309

Panel - Operating / High-Performance Sun II Tempered / Pine Interior
Note: Available by description. Order handle hole plugs (page 22) separately.

Panel - Operating / High-Performance Sun II Tempered / Maple Interior
Note: Available by description. Order handle hole plugs (page 22) separately.

Panel - Operating / High-Performance Sun II Tempered / Oak Interior
Note: Available by description. Order handle hole plugs (page 22) separately.

Panel - Operating / High-Performance Sun II Tempered / Prefinished Interior White
Note: Available by description. Order handle hole plugs (page 22) separately.

Panels - Operating

Panel - Operating / High-Performance Tempered Finelight™ / Pine Interior				
	Unit No.	Pine Interior/ White Exterior	Pine Interior/ Terratone® Exterior	Pine Interior/ Sandtone Exterior
	FWG2668	2566101	By description	0911173
	FWG26611	2566107	By description	0911179
	FWG2680	2566113	By description	0911185
	FWG3068	2566103	2651117	0911175
	FWG30611	2566109	By description	0911181
	FWG3080	2566115	By description	0911187
	FWG4068	2566105	2651119	0911177
	FWG40611	2566111	By description	0911183
	FWG4080	2566117	By description	0911189

Panel - Operating / High-Performance Tempered Finelight™ / Maple Interior				
	Unit No.	Maple Interior/ White Exterior	Maple Interior/ Terratone® Exterior	Maple Interior/ Sandtone Exterior
	FWG2668	By description	By description	By description
	FWG26611	By description	By description	By description
	FWG2680	By description	By description	By description
	FWG3068	2566139	By description	By description
	FWG30611	By description	By description	By description
	FWG3080	By description	By description	By description
	FWG4068	By description	By description	By description
	FWG40611	By description	By description	By description
	FWG4080	By description	By description	By description

Panel - Operating / High-Performance Tempered Finelight™ / Oak Interior				
	Unit No.	Oak Interior/ White Exterior	Oak Interior/ Terratone® Exterior	Oak Interior/ Sandtone Exterior
	FWG2668	2566119	By description	By description
	FWG26611	By description	By description	By description
	FWG2680	By description	By description	By description
	FWG3068	2566121	By description	0911193
	FWG30611	2566127	By description	0911199
	FWG3080	By description	By description	By description
	FWG4068	2566123	By description	By description
	FWG40611	By description	By description	By description
	FWG4080	By description	By description	By description

Frenchwood® Gliding Doors (1987 to Present)

2-Panel, 4-Panel, and Stationary

Panels - Operating

Panel - Operating / High-Performance Tempered Finelight™ / Prefinished Interior White		
	Unit No.	Prefinished Interior White/ White Exterior
	FWG2668	2566275
	FWG26611	2566273
	FWG2680	2566277
	FWG3068	2566281
	FWG30611	2566279
	FWG3080	2566283
	FWG4068	2566287
	FWG40611	2566285
	FWG4080	2566289

Reachout Lock Astragal - Operating - 4-Panel

Note:

Old style astragal are no longer available. Replace with reachout astragal.

Note:

Reachout astragals for custom sized 4-panel doors are made to order. Product ID label is located on top edge of operating panel.

To order, state:

1. Description of part (Reachout Astragal with Screws)
2. Quantity
3. Product ID

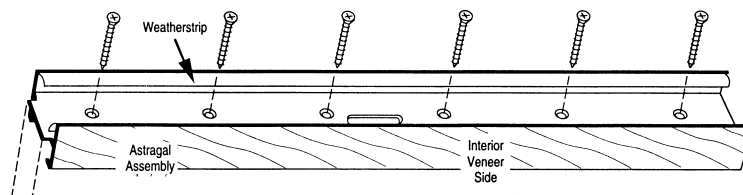

Reachout Lock Astragal with Screws - Operating / 4-Panel / Pine Interior Ref. No. 10 [page 10](#)

Unit No.	Pine Interior/ White Exterior	Pine Interior/ Terratone® Exterior	Pine Interior/ Sandtone Exterior	Pine Interior/ Forest Green Exterior
FWG68	2573204	2653817	0910404	1262701
FWG611	2573207	2653811	0910406	1262702
FWG80	2573205	2653818	0910405	1262703

Panels - Operating

Reachout Lock Astragal with Screws - Operating / 4-Panel / Maple Interior					
	Unit No.	Maple Interior/ White Exterior	Maple Interior/ Terratone® Exterior	Maple Interior/ Sandtone Exterior	Maple Interior/ Forest Green Exterior
	FWG68	2573211	2653802	0910410	1262707
	FWG611	2573213	2653807	0910411	1262708
	FWG80	2573217	2653809	0910412	1262709

Reachout Lock Astragal with Screws - Operating / 4-Panel / Oak Interior					
	Unit No.	Oak Interior/ White Exterior	Oak Interior/ Terratone® Exterior	Oak Interior/ Sandtone Exterior	Oak Interior/ Forest Green Exterior
	FWG68	2573201	2653798	0910407	1262704
	FWG611	2573202	2653799	0910408	1262705
	FWG80	2573203	2653801	0910409	1262706

Reachout Lock Astragal with Screws - Operating / 4-Panel / Prefinished Interior White		
	Unit No.	Prefinished Interior White/ White Exterior
	FWG68	2572998
	FWG611	2572997
	FWG80	2572999

Weatherstrip - Astragal / Inside Ref. No. 14 page 10		
	Color	Order No.
	Gray	2641422
	White	2572919

Weatherstrip - Astragal / Outside Ref. No. 15 page 10		
	Color	Order No.
	Gray	2641424
	White	2572932

Screw Package - Astragal / Reachout		
	Color	Order No.
	White	2573659
	Terratone®	2653833
	Sandtone	0912809
	Forest Green	1262839

Frenchwood® Gliding Doors (1987 to Present)

2-Panel, 4-Panel, and Stationary

Panels - Operating

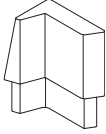
Foam Plug - Astragal / Head	
	Black
	2573212

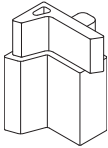
Foam Plug - Astragal / Sill	
	Black
	2573214

Glazing Stops - Operating

Glazing Stop Ref. No. 1 [page 10](#)

Note:

When replacing white painted stops with PVC stops, all 4 sides must be replaced.

Note:

Glazing stops for custom sized doors are made to order. Product ID label is located on top edge of operating panel.

To order, state:

1. Description of part (Glazing Stop, Rail or Stile)
2. Quantity
3. Product ID

Unit No.	Length	Pine	Maple	Oak	Prefinished Interior White
FWG26	21 ¹⁷ / ₃₂	2572812	2572829	2572825	2572347
FWG30	27 ¹⁷ / ₃₂	2572816	2572836	2572833	2572348
FWG40	39 ¹⁷ / ₃₂	2572818	2572837	2572834	2572349
FWG68	64 ⁵⁵ / ₆₄	2572820	2572838	2572835	2572350
FWG611	67 ⁴⁷ / ₆₄	2572824	2572832	2572828	2572351
FWG80	80 ⁵⁵ / ₆₄	2572822	2572830	2572826	2572352

Panels - Operating

Interlock - Set

Note:

See [Service Guide 0005274](#). See [Interlock Set Replacement Video](#).

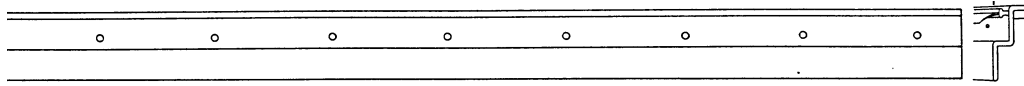

Stationary Panel Interlock

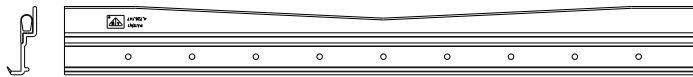

Operating Panel Interlock

Note:

Interlock sets for custom sized doors are made to order. Product ID label is located on top edge of operating panel.

To order, state:

1. Description of part (Interlock Set with Screws)
2. Quantity
3. Product ID

Interlock Set - (2006 to Present) Ref. No. 9 [page 10](#)

	Note: Includes stationary and operating weatherstrip with screws.	Unit No.	Length	White	Sandtone
		GD68	76	2400504	2400501
		GD611	78 ⁷ / ₈	2400503	2400502
		GD80	92	2400508	2400507

Screw Package - Weatherstrip / Interlock

	Color	Order No.
	White	2540085
	Sandtone	2668815

Weatherstrip Set - Interlock (1990 to 2006)

Note:

Use Interlock Set (2006 to Present) as a replacement for all previous vintage weatherstrip material not available.

Weatherstrip Set - Interlock (1987 to 1990)

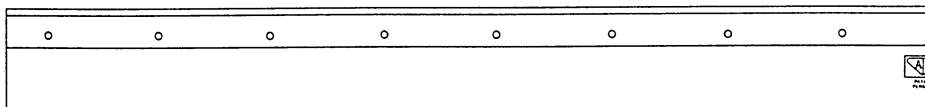

	Set includes: Stationary and operating weatherstrip and screws. Black foam sill plug may also be needed.	Unit No.	Length	Color	Order No.
		FWG68-Repl 87-90	76 ⁷ / ₁₆	White	2572906
				Terratone®	2653806

Frenchwood® Gliding Doors (1987 to Present)

2-Panel, 4-Panel, and Stationary

Panels - Operating

Panel Parts - Operating

Filler with Weatherstrip - Operating / Bottom Rail Ref. No. 5 [page 10](#)

Note:

Use gray for replacement where Terratone® and Sandtone are not available.

Note:

Filler for custom sized doors are made to order. Product ID label is located on top edge of operating panel.

To order, state:

1. Description of part (Operating Bottom Rail Filler)
2. Handing (RH or LH)
3. Quantity
4. Product ID

Filler with Screws - Operating / Bottom Rail with Weatherstrip

	Unit No.	Length	Gray	White	Terratone®	Sandtone
	PS5/FWG2668	30	2641407	1997070	2641021	N/A
	FWG3068/611	36	2641408	2572716	N/A	N/A
	FWG4068/611	48	2641409	2572718	N/A	N/A

 80 Height Bottom Rail Filler	FWG26/80	30	2653715	2572715	N/A	N/A
	FWG30/80	36	2653717	2572717	N/A	N/A
	FWG40/80	48	2653719	2572719	N/A	N/A

Weatherstrip - Operating / Bottom Rail / Fin Seal Ref. No. 6 [page 10](#)

Note:

Bottom rail fin seal weatherstrip is no longer available. Replace with bottom rail filler with Weatherstrip (above).

Trim Piece - Operating / Meeting Stile / Universal Ref. No. 4 [page 10](#)

Unit No.	Length	Pine	Oak	Maple	White
FWG68	76 ⁹ / ₆₄	2573008	2570363	2570369	2570375
FWG611	79 ¹ / ₆₄	2573009	2570364	2570370	2570376
FWG80	92 ⁹ / ₆₄	2573014	2570365	2570371	2570377

Tandem Roller with Bracket (1982 to Present) No. 7 [page 10](#)

Note:

See [Roller Replacement Video](#).

	Order No.
	1997061

Panels - Operating

Tandem Roller (1998 to Present)		
Note: See Roller Replacement Video .		
	Description	Order No.
	Only 80/ DP upgrade	2573517

Hole Plug - Operating / Handle		
	Note: Part is not visible.	Gray
		0912712

Hole Plug and Sleeve- Operating / Roller (1991 to Present) No. 8 page 10			
		Color	Order No.
		White	9014683
		Terratone®	9014685
		Sandtone	9014684
		Tycote	9014686
		Canvas	9046445

Hole Plug - Operating / Roller (Prior to 1991)		
	Description	White
	Tycote surface	2573620

Panels - Stationary

Illustration Stationary Panels

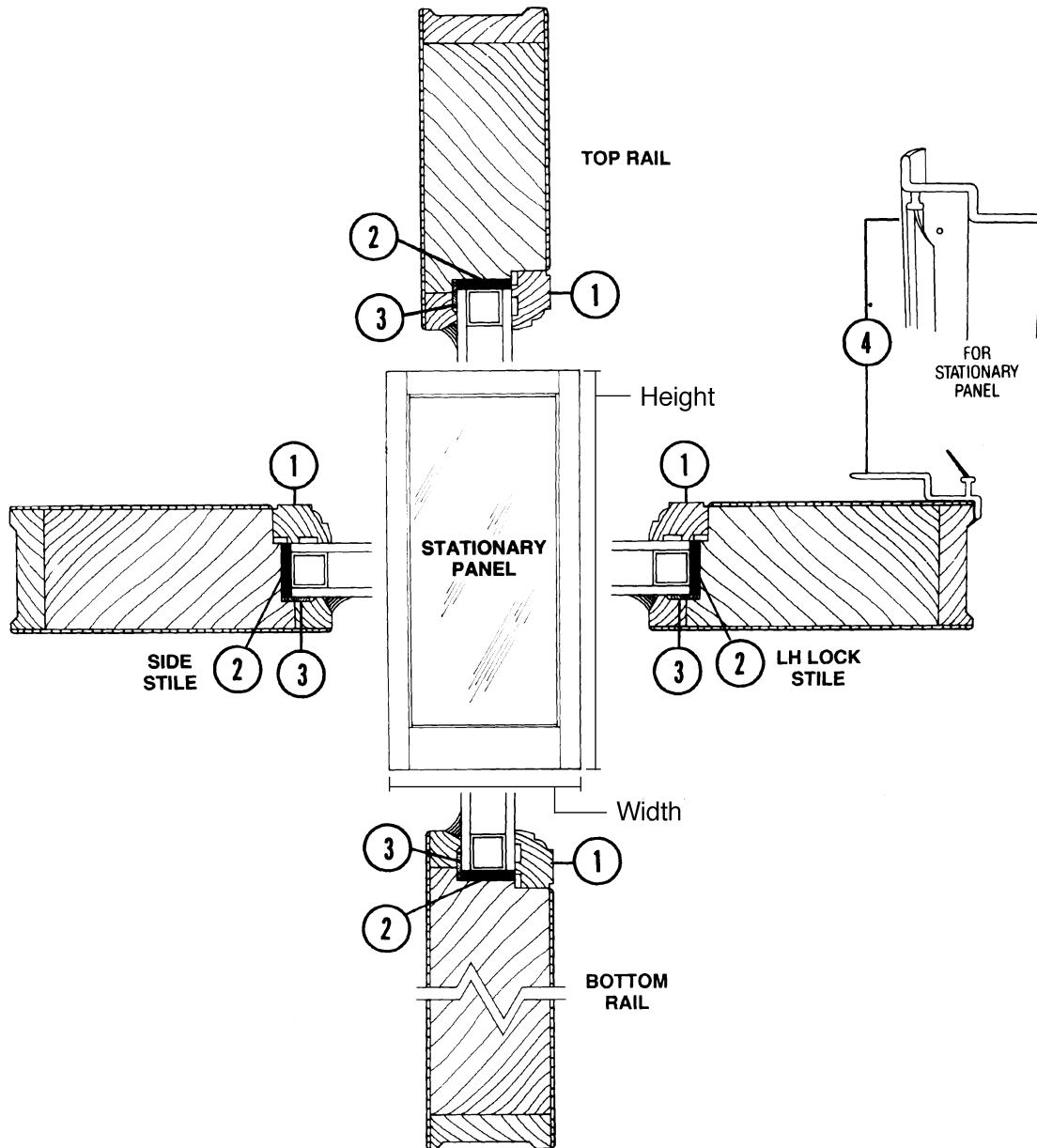

- 1. [Glazing Stop](#)
- 2. [Glass Spacers](#)
- 3. [Silicone Glazing](#)
- 4. [Interlock W/S, Meeting Stile](#)

Frenchwood® Gliding Stationary Panel (Left Hand Shown)

Unit viewed from exterior.

Panels - Stationary

Size Table - Stationary Panels

Note:

Stationary Panel is measured outside edge to outside edge of frame.

Unobstructed *Glass* is dimension from outside edge to outside edge of visible glass only.

Actual Glass is dimension of outside edge to outside edge of glass, including glass that is not visible.

1" Finelight™ grille profile is standard, with color matching exterior color of panel. Maple and Oak finishes introduced in 1999. Pre-finished white introduced in 2000.

Unit No.	Stationary Panel (w x h)	Unobstructed Glass (w x h)	Actual Glass (w x h)
FWG2668	30 × 76 ⁹ / ₆₄	21 ¹ / ₈ × 63 ¹ / ₈	22 ¹ / ₄ × 64 ¹ / ₄
FWG26611	30 × 79 ¹ / ₆₄	21 ¹ / ₈ × 66	22 ¹ / ₄ × 67 ¹ / ₈
FWG2680	30 × 92 ⁹ / ₆₄	21 ¹ / ₈ × 79 ¹ / ₈	22 ¹ / ₄ × 80 ¹ / ₄
FWG3068	36 × 76 ⁹ / ₆₄	27 ¹ / ₈ × 63 ¹ / ₈	28 ¹ / ₄ × 64 ¹ / ₄
FWG30611	36 × 79 ¹ / ₆₄	27 ¹ / ₈ × 66	28 ¹ / ₄ × 67 ¹ / ₈
FWG3080	36 × 92 ⁹ / ₆₄	27 ¹ / ₈ × 79 ¹ / ₈	28 ¹ / ₄ × 80 ¹ / ₄
FWG4068	48 × 76 ⁹ / ₆₄	39 ¹ / ₈ × 63 ¹ / ₈	40 ¹ / ₄ × 64 ¹ / ₄
FWG40611	48 × 79 ¹ / ₆₄	39 ¹ / ₈ × 66	40 ¹ / ₄ × 67 ¹ / ₈
FWG4080	48 × 92 ⁹ / ₆₄	39 ¹ / ₈ × 79 ¹ / ₈	40 ¹ / ₄ × 80 ¹ / ₄

Stationary Panels

Note:

Stationary panels for custom sized doors are made to order. Product ID label is located on top edge of operating panel.

To order, state:

1. Description of part (Stationary Panel)
2. Handing (RH or LH)
3. Quantity
4. Product ID
5. Options Desired (if different than original product)

Panel - Stationary / High-Performance Tempered / Pine Interior

	Unit No.	Pine Interior/ White Exterior	Pine Interior/ Terratone® Exterior	Pine Interior/ Sandtone Exterior	Pine Interior/ Forest Green Exterior
	FWG2668	2565906	2651006	0911004	1262137
	FWG26611	2565903	2651003	0911005	1262139
	FWG2680	2565926	2651026	0911024	1262141
	FWG3068	2565910	2651010	0911008	1262145
	FWG30611	2565918	2651018	0911016	1262147
	FWG3080	2565930	2651030	0911028	1262149
	FWG4068	2565914	2651014	0911012	1262151
	FWG40611	2565920	2651020	0911018	1262153
	FWG4080	2565934	2651034	0911032	1262155

Frenchwood® Gliding Doors (1987 to Present)

2-Panel, 4-Panel, and Stationary

Panels - Stationary

Panel - Stationary / High-Performance Tempered / Maple Interior					
	Unit No.	Maple Interior/ White Exterior	Maple Interior/ Terratone® Exterior	Maple Interior/ Sandtone Exterior	Maple Interior/ Forest Green Exterior
	FWG2668	2566238	2651070	0910975	By description
	FWG26611	2566236	2651078	0910976	By description
	FWG2680	2566250	By description	By description	By description
	FWG3068	2566240	2651074	0910978	1262163
	FWG30611	2566246	2651080	0910984	By description
	FWG3080	2566252	2651086	0910990	By description
	FWG4068	2566242	2651076	0910980	By description
	FWG40611	2566248	2651082	0910986	By description
	FWG4080	2566254	2651031	0910992	By description

Panel - Stationary / High-Performance Tempered / Oak Interior					
	Unit No.	Oak Interior/ White Exterior	Oak Interior/ Terratone® Exterior	Oak Interior/ Sandtone Exterior	Oak Interior/ Forest Green Exterior
	FWG2668	2566218	2651050	0910949	1262175
	FWG26611	2566216	2651058	0910950	1262177
	FWG2680	2566230	2651064	0910962	1262179
	FWG3068	2566220	2651054	0910952	1262181
	FWG30611	2566226	2651060	0910958	1262183
	FWG3080	2566232	2651066	0910964	1262185
	FWG4068	2566222	2651056	0910954	1262187
	FWG40611	2566228	2651062	0910960	1262189
	FWG4080	2566234	2651068	0910966	1262191

Panel - Stationary / High-Performance Tempered / Prefinished Interior White		
	Unit No.	Prefinished Interior White/ White Exterior
	FWG2668	2566202
	FWG26611	2566258
	FWG2680	2566260
	FWG3068	2566264
	FWG30611	2566262
	FWG3080	2566266
	FWG4068	2566270
	FWG40611	2566268
	FWG4080	2566272

Panels - Stationary

Panel - Stationary / High-Performance Tempered / Smart Sun / Pine Interior				
	Unit No.	White Exterior	Terratone® Exterior	Sandtone Exterior
	FWG2668	By description	By description	By description
	FWG26611	By description	By description	By description
	FWG2680	By description	By description	By description
	FWG3068	9021469	9021403	9021402
	FWG30611	By description	By description	By description
	FWG3080	By description	By description	By description
	FWG4068	9021471	9021407	9021406
	FWG40611	By description	By description	By description
	FWG4080	By description	By description	By description

Panel - Stationary / High-Performance Sun 3 Tempered / Pine Interior				
	Unit No.	Pine Interior/ White Exterior	Pine Interior/ Terratone® Exterior	Pine Interior/ Sandtone Exterior
	FWG2668	2566006	2651206	0911104
	FWG26611	2566003	2651203	0911105
	FWG2680	2566036	2651226	0911124
	FWG3068	2566020	2651210	0911108
	FWG30611	2566028	2651218	0911116
	FWG3080	2566040	2651230	0911128
	FWG4068	2566024	2651214	0911112
	FWG40611	2566030	2651220	0911118
	FWG4080	2566044	2651234	0911132

Panel - Stationary / High-Performance Sun 3 Tempered / Maple Interior				
	Unit No.	Maple Interior/ White Exterior	Maple Interior/ Terratone® Exterior	Maple Interior/ Sandtone Exterior
	FWG2668	2566068	By description	By description
	FWG26611	By description	By description	By description
	FWG2680	By description	By description	By description
	FWG3068	2566070	2651265	0911146
	FWG30611	By description	By description	By description
	FWG3080	By description	By description	0911158
	FWG4068	2566072	By description	0911160
	FWG40611	By description	By description	By description
	FWG4080	By description	By description	By description

Frenchwood® Gliding Doors (1987 to Present)

2-Panel, 4-Panel, and Stationary

Panels - Stationary

Panel - Stationary / High-Performance Sun 3 Tempered / Oak Interior				
	Unit No.	Oak Interior/ White Exterior	Oak Interior/ Terratone® Exterior	Oak Interior/ Sandtone Exterior
	FWG2668	2566048	2651237	0911109
	FWG26611	2566046	2651236	0911111
	FWG2680	2566060	2651249	0911136
	FWG3068	2566050	2651239	0911120
	FWG30611	2566056	2651245	0911131
	FWG3080	2566062	2651251	0911138
	FWG4068	2566052	2651241	0911123
	FWG40611	2566058	2651247	0911134
	FWG4080	2566064	2651253	0911140

Panel - Stationary / High-Performance Sun 3 Tempered / Prefinished Interior White		
	Unit No.	Prefinished Interior White/ White Exterior
	FWG2668	2566292
	FWG26611	2566294
	FWG2680	2566296
	FWG3068	2566301
	FWG30611	2566298
	FWG3080	2566303
	FWG4068	2566307
	FWG40611	2566305
	FWG4080	2566311

Panel - Stationary / High-Performance Sun II Tempered / Pine Interior
Note: Available by description.

Panel - Stationary / High-Performance Sun II Tempered / Maple Interior
Note: Available by description.

Panel - Stationary / High-Performance Sun II Tempered / Oak Interior
Note: Available by description.

Panel - Stationary / High-Performance Sun II Tempered / Prefinished Interior White
Note: Available by description.

Panels - Stationary

Panel - Stationary / High-Performance Tempered Finelight™ / Pine Interior				
	Unit No.	Pine Interior/ White Exterior	Pine Interior/ Terratone® Exterior	Pine Interior/ Sandtone Exterior
	FWG2668	2566102	By description	0911174
	FWG26611	2566108	By description	0911180
	FWG2680	2566114	By description	0911186
	FWG3068	2566104	2651118	0911176
	FWG30611	2566110	2651124	0911182
	FWG3080	2566116	By description	0911188
	FWG4068	2566106	By description	0911178
	FWG40611	2566112	By description	0911184
	FWG4080	2566118	By description	0911190

Panel - Stationary / High-Performance Tempered Finelight™ / Maple Interior				
	Unit No.	Maple Interior/ White Exterior	Maple Interior/ Terratone® Exterior	Maple Interior/ Sandtone Exterior
	FWG2668	By description	By description	By description
	FWG26611	By description	By description	By description
	FWG2680	By description	By description	By description
	FWG3068	2566140	By description	By description
	FWG30611	By description	By description	By description
	FWG3080	By description	By description	By description
	FWG4068	By description	By description	By description
	FWG40611	By description	By description	By description
	FWG4080	By description	By description	By description

Panel - Stationary / High-Performance Tempered Finelight™ / Oak Interior				
	Unit No.	Oak Interior/ White Exterior	Oak Interior/ Terratone® Exterior	Oak Interior/ Sandtone Exterior
	FWG2668	2566120	By description	By description
	FWG26611	By description	By description	By description
	FWG2680	By description	By description	0911205
	FWG3068	2566122	By description	0911194
	FWG30611	2566128	By description	0911201
	FWG3080	By description	By description	By description
	FWG4068	2566124	By description	By description
	FWG40611	By description	By description	By description
	FWG4080	By description	By description	By description

Frenchwood® Gliding Doors (1987 to Present)

2-Panel, 4-Panel, and Stationary

Panels - Stationary

Panel - Stationary / High-Performance Tempered Finelight™ / Prefinished Interior White		
	Unit No.	Prefinished Interior White/ White Exterior
	FWG2668	2566276
	FWG26611	2566274
	FWG2680	2566278
	FWG3068	2566282
	FWG30611	2566280
	FWG3080	2566284
	FWG4068	2566288
	FWG40611	2566286
	FWG4080	2566290

Glazing Stops - Stationary

Glazing Stop Ref. No. 1 [page 10](#)

Note:

When replacing white painted stops with PVC stops, all 4 sides must be replaced.

Note:

Glazing stops for custom sized doors are made to order. Product ID label is located on top edge of operating panel.

To order, state:

1. Description of part (Glazing Stop, Rail or Stile)
2. Quantity
3. Product ID

Unit No.	Length	Pine	Maple	Oak	Prefinished Interior White
FWG26	21 ¹⁷ / ₃₂	2572812	2572829	2572825	2572347
FWG30	27 ¹⁷ / ₃₂	2572816	2572836	2572833	2572348
FWG40	39 ¹⁷ / ₃₂	2572818	2572837	2572834	2572349
FWG68	64 ⁵⁵ / ₆₄	2572820	2572838	2572835	2572350
FWG611	67 ⁴⁷ / ₆₄	2572824	2572832	2572828	2572351
FWG80	80 ⁵⁵ / ₆₄	2572822	2572830	2572826	2572352

Panels - Stationary

Interlock - Set

Note:
See [Service Guide 0005274](#). See [Interlock Set Replacement Video](#).

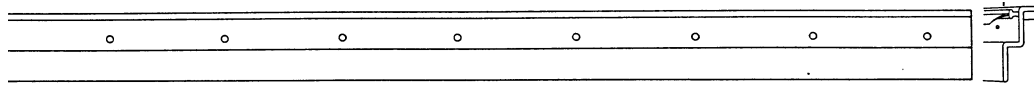

Stationary Panel Interlock



Operating Panel Interlock

Note:
Interlock sets for custom sized doors are made to order. Product ID label is located on top edge of operating panel.

To order, state:

1. Description of part (Interlock Set with Screws)
2. Quantity
3. Product ID

Interlock Set - (2006 to Present) Ref. No. 9 [page 10](#)

Note: Includes stationary and operating weatherstrip with screws.	Unit No.	Length	White	Gray
	GD68	76	2400504	2400501
	GD611	78 ⁷ / ₈	2400503	2400502
	GD80	92	2400508	2400507

Screw Package - Weatherstrip / Interlock

Color	Order No.
White	2540085
Sandtone	2668815

Weatherstrip Set - Interlock (1990 to 2006)

Note:
Use Interlock Weatherstrip Set (2006 to Present) as a replacement for all previous vintage weatherstrip material not available.

Weatherstrip Set - Interlock (1987 to 1990)

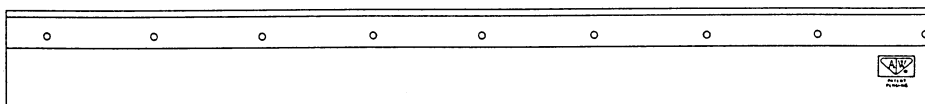

Set includes: Stationary and operating weatherstrip and screws. Black foam sill plug may also be needed.	Unit No.	Length	Color	Order No.
	FWG68-Repl 87-90	76 ⁷ / ₁₆	White	2572906
			Terratone®	2653806

Frenchwood® Gliding Doors (1987 to Present)

2-Panel, 4-Panel, and Stationary

Panels - Stationary

Panel Parts - Stationary

Bracket with Screws - Stationary / Universal

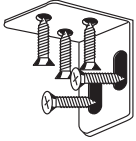

Note:
See [Service Guide 9018154](#).

Unit No.	Finish	Order No.
FWG68/80 (Universal)	Stone	2573551
	White	2573549

Insect Screens

Illustration Screen - 2 & 4 Panel - Current (1991 to Present)

*Circled numbers with no directional lines refer to parts not shown in drawing, but are listed below or see hardware section.

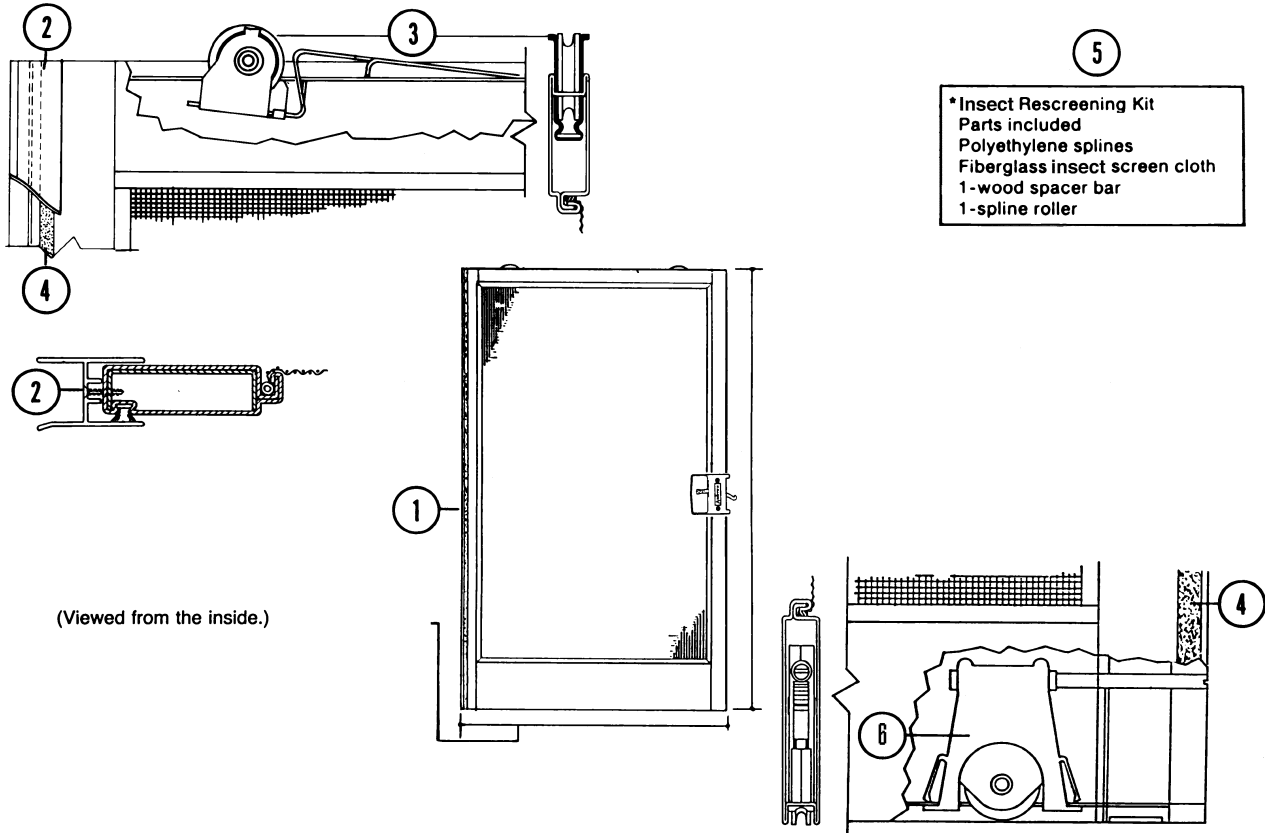

5

*Insect Rescreening Kit
Parts included
Polyethylene splines
Fiberglass insect screen cloth
1-wood spacer bar
1-spline roller

(Viewed from the inside.)

1. [Insect Screen](#)
2. [Insect Screen Astragal - 4-panel Door](#)
3. [Upper Insect Screen Roller](#)
4. [Bug Seal Pile Weatherstrip](#)
5. [Insect Rescreening Kit](#)
8. [Bottom Insect Screen Roller](#)

Manufactured 1991 to Present

Frenchwood® Gliding Insect Screen

Unit viewed from interior.

Illustration Screen - 2 & 4 Panel - Vintage (1987 to 1991)

Note:

Use current model of insect screen for replacement. Other replacement parts are available.

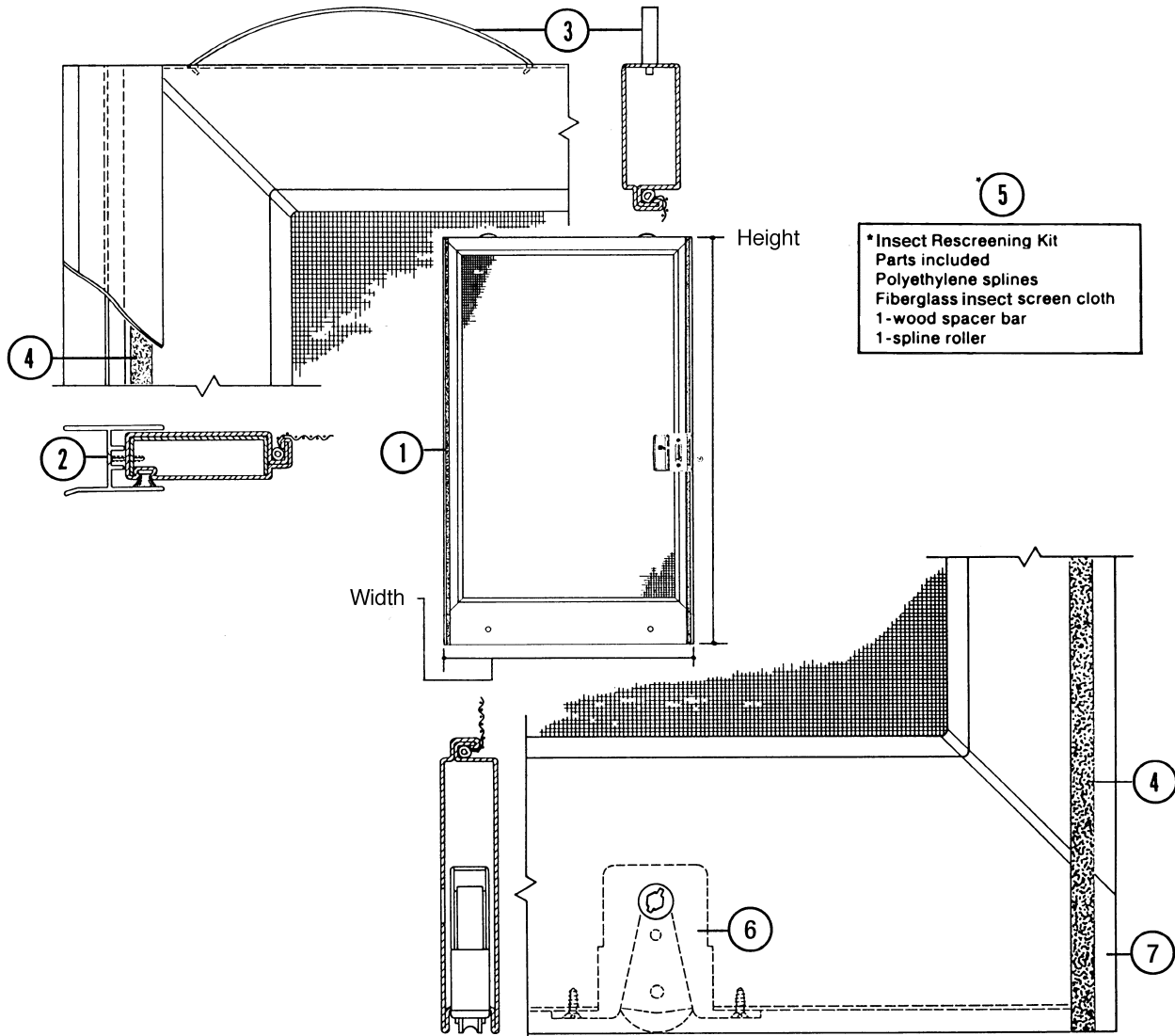

- 1. [Insect Screen](#)
- 2. [Astragal, Insect Screen W/Screws - 4-Panel Door](#)
- 3. [Spring, Top Door](#)
- 4. [Bug Seal Pile Weatherstrip](#)
- 5. [Insect Rescreening Kit](#)
- 6. [Bottom Insect Screen Roller](#)
- 7. [End Caps, Insect Screen Bottom Rail](#)

Manufactured 1987 to 1991

Frenchwood® Gliding Insect Screen

Unit viewed from interior.

Insect Screens

Gliding Insect Screens (1987 to Present) Ref. No. 1 [page 32](#)

Note:

Gliding insect screen for custom sized doors are made to order. Product ID label is located on top edge of operating panel. Replacement screens ship with top and bottom rollers and hardware. See [Accessory Guide 0001666](#)

To order, state:

1. Description of part (Gliding Insect Screen)
2. Quantity
3. Product ID
4. Options Desired (if different than original product)

Gliding Screen Usage Guide		
Use This Unit No.	On This FWG Two Panel Door	On This FWG Four Panel Door
PD2668	FWG5068	FWG10068
PD26611	FWG50611	FWG100611
PD2680	FWG5080	FWG10080
PD3068	FWG6068	FWG12068
PD30611	FWG60611	FWG120611
PD3080	FWG6080	FWG12080
PD4068	FWG8068	FWG16068
PD40611	FWG80611	FWG160611
PD4080	FWG8080	FWG16080

Unit No.	Dimensions	White	Terratone®	Sandtone	Forest Green
PD2668	29 1/2 × 77 9/16	1974128	2601022	0900202	1262501
PD26611	29 1/2 × 80 7/16	2565309	2650309	0910105	1262505
PD2680	29 1/2 × 93 9/16	2576018	2666018	0910112	1262509
PD3068	35 1/2 × 77 9/16	2565308	2650306	0910102	1262503
PD30611	35 1/2 × 80 7/16	2565311	2650311	0910107	1262507
PD3080	35 1/2 × 93 9/16	2576022	2666022	0910114	1262511
PD4068	47 1/2 × 77 9/16	2565316	2650308	0910104	1262504
PD40611	47 1/2 × 80 7/16	2565312	2650312	0910108	1262508
PD4080	47 1/2 × 93 9/16	2565328	2650328	0910116	1262512

Rescreening Kits - Gliding Insect Screen

Rescreening Kit - Gliding Insect Screen (1987 to Present) Ref. No. 5 [page 32](#)

<p>Note: One size fits all doors. See Service Guide 0001667.</p> <p>Kit includes: Polyethylene splines Fiberglass insect screen cloth 1-wood spacer bar 1-spline roller</p>	Order No.
	1274712

Frenchwood® Gliding Doors (1987 to Present)

2-Panel, 4-Panel, and Stationary

Insect Screens

Gliding Insect Screen Hardware/ 2 Panel/ Current

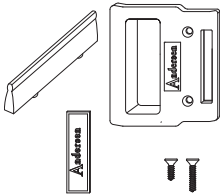
	Package includes: logo plate, interior pull, exterior pull, (2) 6 x 5/8" screws, (2) 6 x 1" screws	Finish	Order No.
		Stone	2650504
		White	1997230
		Forest Green	1262834

Pull - Insect Screen / Universal / 2 and 3 Panel / Interior

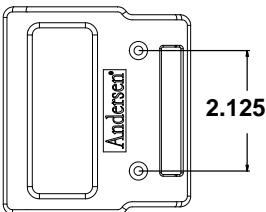
		Finish	Order No.
		Stone	1997194
		White	1997306
		Forest Green	1267818

Pull - Insect Screen / Universal / 2 and 3 Panel / Exterior

		Finish	Order No.
		Stone	1997195
		White	1997307
		Forest Green	1267819

Logo Plate with Screws - Insect Screen / Gliding / 2- and 3-Panel

		Finish	Order No.
		Stone	2641206
		White	1997197
		Forest Green	1262841

Door Latch with Screws - Gliding Insect Screen / 2-Panel

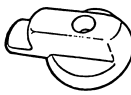
	Note: Also used for single retractable screen.	Finish	Order No.
		Stone	0924602
		White	2579551
		Forest Green	1267822

Insect Screens

Screw - Insect Screen / Gliding / Lock Fillister / Head		
	Note: Screw for door latch	Order No.
		2573636

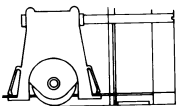
Wheel Assembly - Insect Screen / Lower (1991 to Present) Ref. No. 4 page 32		
	Note: Need two (2) per insect screen.	Order No.
		1997310

Wheel Assembly - Insect Screen / Upper (1991 to Present) Ref. No. 8 page 32		
	Note: Need two (2) per insect screen.	Order No.
		1997063

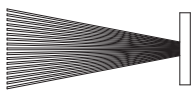
Bug Seal - Insect Screen / Gliding Ref. No. 3 page 32		
	Note: Order by the foot. Used to replace gliding screen weatherstrip.	Order No.
		2579073

Insect Screen Retainer with Screws					
	Note: The insect screen retainer on white units is permanently attached and is not replaceable.	Unit No.	Terratone®	Sandtone	Forest Green
		PS65/FWG68	2641202	0903430	1262826
		PS68/FWG611	2641204	0903432	1262827
		PS80/FWG80	2653626	0912326	1262828

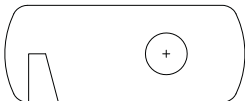
Hook- Insect Screen		
		Order No.
		2579546

Frenchwood® Gliding Doors (1987 to Present)

2-Panel, 4-Panel, and Stationary

Insect Screens

Gliding Insect Screen Hardware/ 2 Panel/ Vintage

Door Lock / Gliding Insect Screen / 2-Panel (1987 to 1991)

	Note: Screw for door latch is part number 2573636 See illustration, page 36	Finish	Order No.
		Stone	1997192
		White	2573866

Handle - Insect Screen / Gliding / Interior / 2- and 3-Panel (1982 to 1991)

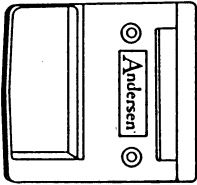
	Note: Use current insect screen pull page 35	Finish	Order No.
		Stone	N/A
		White	N/A

Spring - Upper / Gliding Insect Screen (1983 to 1991) Ref. No. 3 [page 33](#)

	X	Order No.
		1997196

Roller - Insect Screen / Lower (1982 to 1991) Ref. No. 6 [page 33](#)

	Note: Need two (2) per screen.	Order No.
		1274104

Screw - Lower Roller/ Gliding Insect Screen (1982 to 1991)

	Note: Need two (2) per roller	Order No.
		3620400

Insect Screens

Gliding Insect Screen Hardware/ 4 Panel Door

Astragal with Hardware - Gliding Insect Screen / 4 Panel Ref. No. 2 [page 32](#)

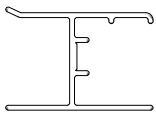
	Note: Includes astragal, pulls, locking lever and screws. See Accessory Guide 0004194 .						
	Unit No.	Length	White	Terratone®	Sandtone	Forest Green	Canvas
	FWG68	77	2565712	2650508	0910302	1262710	9053838
	FWG611	79 ⁷ / ₈	2565711	2650509	0910303	1262711	9053839
FWG80	93	2565713	2650510	0910304	1262712	9053840	

Hardware Package - Gliding Insect Screen / Astragal / 4-Panel (1987 to Present)

Kit Includes: 4-Panel Inside Pull (Qty 2) 4-Panel Locking Lever (Qty 2) Screws Accessory Guide 0000149 .	Finish	Order No.
	White	2565610
	Terratone®/ Sandtone	2650506
	Forest Green	9061982
	Canvas	9061983

Pull with Screws - Inside / Gliding Insect Screen / 4-Panel (1987 to Present)

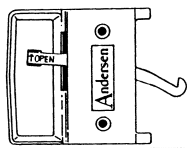
	Note: The insect screen locking lever, shown in the drawing, must be ordered separately, below.	
	Finish	Order No.
	Stone	2573610
	White	2573864
	Forest Green	1267821

Locking Lever - Astragal / Gliding Insect Screen / 4-Panel (1987 to Present)

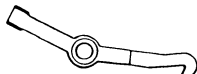
	Order No.
	2573608

Bracket - Insect Screen / Head Stop

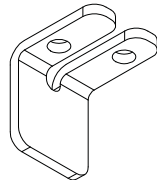
	Note: Use on 4-panel doors	
	Finish	Order No.
	White	2573613
	Gray	2653819

Frenchwood® Gliding Doors (1987 to Present)

2-Panel, 4-Panel, and Stationary

Insect Screens

Retractable Insect Screens/ Current (June 2007 to Present)

Note:

See [Accessory Guide 0005478](#).

Insect Screen - Retractable (June 2007 to Present)

Unit No.	White		Terratone®		Sandtone		Forest Green	
	Left	Right	Left	Right	Left	Right	Left	Right
PS510	2517682	1900004	2641756	2641740	0900176	0900160	9056460	9056459
PD5068	2517673	1900001	2641747	2641737	0900167	0900157	1205660	1205651
PD50611	2517674	1900002	2641748	2641738	0900168	0900158	1205661	1205652
PD5080	2517675	1900003	2641749	2641739	0900169	0900159	1205662	1205653
PD6068	2517676	1900005	2641750	2641741	0900170	0900161	1205663	1205654
PD60611	2517677	1900006	2641751	2641742	0900171	0900162	1205664	1205655
PD6080	2517678	1900007	2641752	2641743	0900172	0900163	1205665	1205656
PD8068	2517679	1900008	2641753	2641744	0900173	0900164	1205666	1205657
PD80611	2517680	1900009	2641754	2641745	0900174	0900165	1205667	1205658
PD8080	2517681	1900010	2641755	2641746	0900175	0900166	1205668	1205659

Retractable Insect Screen Parts/ Current (June 2007 to Present)

Track - Top / Retractable Insect Screen (June 2007 to Present)

Unit No.	White		Terratone®		Sandtone		Forest Green	
	Left	Right	Left	Right	Left	Right	Left	Right
PD50	2562467	2562461	2605180	2605174	0916065	0916059	1232868	1232865
PD60	2562468	2562462	2605181	2605175	0916066	0916060	1232869	1232866
PD80	2562469	2562463	2605182	2605176	0916067	0916061	1232870	1232867

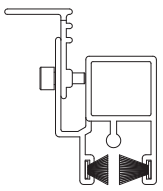

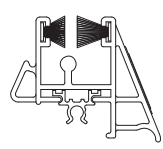

Track - Bottom / Retractable Insect Screen (June 2007 to Present)

Unit No.	Order No.	
	Left	Right
PD50	2562464	2562458
PD60	2562465	2562459
PD80	2562466	2562460

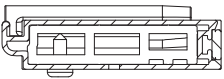

Insect Screens

Slide Bar Assembly - Retractable Insect Screen <i>(June 2007 to Present)</i>									
	Unit No.	White		Terratone®		Sandtone		Forest Green	
		Left	Right	Left	Right	Left	Right	Left	Right
	PD68	2562434	2562431	2605168	2605165	0916053	0916050	1232859	1232856
	PD611	2562435	2562432	2605169	2605166	0916054	0916051	1232860	1232857
	PD80	2562436	2562433	2605170	2605167	0916055	0916052	1232861	1232858

Slide Bar - Retractable Insect Screen <i>(June 2007 to Present)</i>									
	Unit No.	White		Terratone®		Sandtone		Forest Green	
		Left	Right	Left	Right	Left	Right	Left	Right
	PD68	2562425	2562498	2605162	2605186	0916047	0916071	1232853	1232871
	PD611	2562426	2562499	2605163	2605187	0916048	0916072	1232854	1232872
	PD80	2562427	2562501	2605164	2605188	0916049	0916073	1232855	1232873

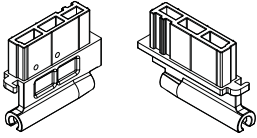
Slide Body - Retractable Insect Screen <i>(June 2007 to Present)</i>				
 Left Right	Note: A left hand screen will use a left hand slide body on the sill and a right hand slide body on the head.	Color	Left	Right
		White	2562449	2562450
		Terratone®	2605171	2605172
		Sandtone	0916056	0916057
		Forest Green	1232862	1232863

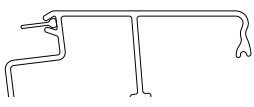
Track Filler with Sill Sweep - Bottom / Retractable Insect Screen <i>(June 2007 to Present)</i>		
	Unit No.	Order No.
	PD50	2562422
	PD60	2562423
	PD80	2562424

Frenchwood® Gliding Doors (1987 to Present)

2-Panel, 4-Panel, and Stationary

Insect Screens

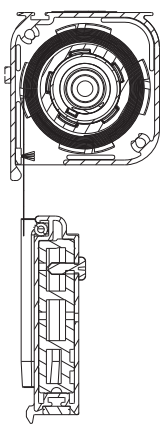
Canister Assembly - Retractable Insect Screen (June 2007 to Present)									
	Unit No.	White		Terratone®		Sandtone		Forest Green	
		Left	Right	Left	Right	Left	Right	Left	Right
	FWG5068 /6068	2562361	2562355	2605144	2605138	0916029	0916023	1232835	1232829
	FWG50611/ 60611	2562363	2562357	2605146	2605140	0916031	0916025	1232837	1232831
	FWG5080/ 6080	2562365	2562359	2605148	2605142	0916033	0916027	1232839	1232833
	FWG8068	2562362	2562356	2605145	2605139	0916030	0916024	1232836	1232830
	FWG80611	2562364	2562358	2605147	2605141	0916032	0916026	1232838	1232832
	FWG8080	2562366	2562360	2605149	2605143	0916034	0916028	1232840	1232834

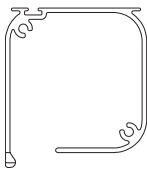
Canister - Retractable Insect Screen (June 2007 to Present)					
	Unit No.	White	Terratone®	Sandtone	Forest Green
	PD68	2562349	2605135	0916020	1232826
	PD611	2562350	2605136	0916021	1232827
	PD80	2562351	2605137	0916022	1232828

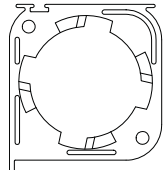
End Cap - Canister / Retractable Insect Screen (June 2007 to Present)				
	Color	Left	Right	
	White	2562380	2562381	
	Terratone®	2605150	2605151	
	Sandtone	0916035	0916036	
	Forest Green	1232841	1232842	

Cloth with Core - Retractable Insect Screen (June 2007 to Present)				
	Unit No.	Left	Right	
	PD6068	2562403	2562518	
	PD60611	2562404	2562519	
	PD6080	2562405	2562520	
	PD8068	2562406	2562521	
	PD80611	2562407	2562522	
	PD8080	2562408	2562523	

Insect Screens

Handle - Retractable Insect Screen / Inside *(June 2007 to Present)*

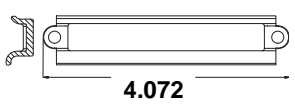
		Color	Unit No.
		White	2562391
		Terratone®	2605153
		Sandtone	0916038
		Forest Green	1232844

Handle - Outside / Retractable Insect Screen *(June 2007 to Present)*

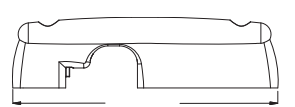
		Color	Unit No.
		White	2562390
		Terratone®	2605152
		Sandtone	0916037
		Forest Green	1232843

Cassette Retainer - Insect Screen / Retractable *(June 2007 to Present)*

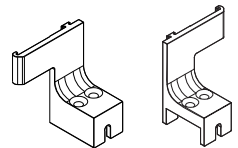
 <p>Left Right</p>	Note: The cassette retainer is referred to as cannister brackets in installation instructions. RH unit uses RH bracket on sill and LH bracket on head.	Color	Left	Right
		White	2562401	2562402
		Terratone®	2605157	2605156
		Sandtone	0916041	0916042
		Forest Green	1232847	1232848

Magnet - Side Bar / Retractable Insect Screen (Pair) *(June 2007 to Present)*

Note: Includes one side jamb magnet and one slide bar magnet. Comes as 80 height and cut to size as necessary.	Order No.
	2573137

Spring Tensioner - Insect Screen / Retractable *(June 2007 to Present)*

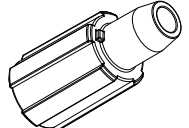
	Order No.
	2562454

Spring - Tension - Insect Screen / Retractable *(June 2007 to Present)*

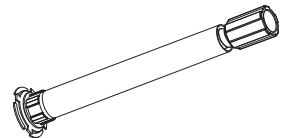
	Order No.
	2562456

Frenchwood® Gliding Doors (1987 to Present)

2-Panel, 4-Panel, and Stationary

Insect Screens

Weatherstrip Pile - Interior Canister - Insect Screen / Retractable (June 2007 to Present)

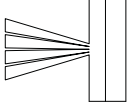
		Order No.
		2562497

Bug Pile - Barb Spacer / Insect Screen / Retractable (June 2007 to Present)

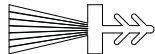
		Unit No.	Order No.
		PD80	2562340

Bug Pile - Head and Sill Track Kit / Insect Screen / Retractable (June 2007 to Present)

		Unit No.	Order No.
		PD80	2562341

Bug Pile - Slide Bar Kit / Insect Screen / Retractable (June 2007 to Present)

		Unit No.	Order No.
		PD80	2562342

Bumper - Insect Screen / Retractable (June 2007 to Present)

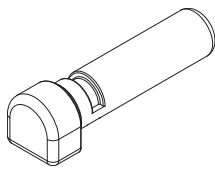
		White	Gray
		2562343	2562344

Bumper - Stop Extension / Insect Screen / Retractable (June 2007 to Present)

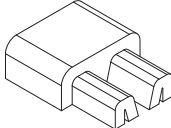
		White	Gray
		2562345	2562346

Bushing - Retractable Insect Screen (June 2007 to Present)

		Order No.
		2562347

Insect Screens

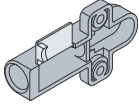
Bumper Housing - Retractable Insect Screen (June 2007 to Present)			
	Note: Installation instructions refer to this part as a "damper".	Color	Unit No.
		White	2562395
		Terratone®	2605155
		Sandtone	0916040
		Forest Green	1232846

Stud/Bolt - Retractable Insect Screen (June 2007 to Present)		
	Color	Unit No.
	White	2562455
	Terratone®	2605173
	Sandtone	0916058
	Forest Green	1232864

Hardware Pack - Retractable Insect Screen (June 2007 to Present)		
Pack Includes: 1 - Bumper - panel stop extension 1 - Passive handle 2 - Housing dampener 1 - Interior handle 2 - Bumpers - finger pinch 2 - Tapped studs 1 - Retainer cassette, left 1 - Retainer cassette, right 1 - Sill anchor 5 - Screws - 8 -11 x 1 vinyl thread #7 pan head Phillips 4 - Screws - 6-20 x .38 sheet metal screws 2 - 8-32 1.5 SS PN DH Phillips machine screw 1 - 8-32 x .5 SS flat HD Phillips 2 - 8-18 x 1.5 SS flat HD Phillips	Color	Unit No.
	White	2562392
	Terratone®	2605154
	Sandtone	0916039
	Forest Green	1232845

Screw - Retractable Insect Screen (June 2007 to Present)			
	Description	Color	Order No.
	8-32 x 1/2 PH FL	White	2562414
		Terratone®	2605158
		Sandtone	0916043
		Forest Green	1232849

Screw - Retractable Insect Screen (June 2007 to Present)			
	Description	Color	Order No.
	6-20 x 3/8 PH PAN	White	2562417
		Terratone®	2605159
		Sandtone	0916044
		Forest Green	1232850

Frenchwood® Gliding Doors (1987 to Present)

2-Panel, 4-Panel, and Stationary

Insect Screens

Screw - Retractable Insect Screen <i>(June 2007 to Present)</i>			
	Description	Color	Order No.
	8 x 1 PH PAN	White	2562419
		Terratone®	2605160
		Sandtone	0916045
		Forest Green	1232851
Screw - Retractable Insect Screen <i>(June 2007 to Present)</i>			
	Description	Color	Order No.
	8-32 x 1 1/2 PH PAN SS	White	2562420
		Terratone®	2605161
		Sandtone	0916046
		Forest Green	1232852
Screw - Anchor / Sill / Insect Screen / Retractable <i>(June 2007 to Present)</i>			
			Gray
			2562339
Screw - Insect Screen / Retractable <i>(June 2007 to Present)</i>			
	Description	Order No.	
	6-32 x 1/2 PH FL TYP F	2562412	
Screw - Insect Screen / Retractable <i>(June 2007 to Present)</i>			
	Description	Order No.	
	8 x 1 1/2 PH FL	2562413	
Screw - Insect Screen / Retractable <i>(June 2007 to Present)</i>			
	Description	Order No.	
	8-18 x 1 1/2 PH PAN SS	2562421	

Insect Screens

Retractable Insect Screen/ Vintage (August 2003 to May 2007)

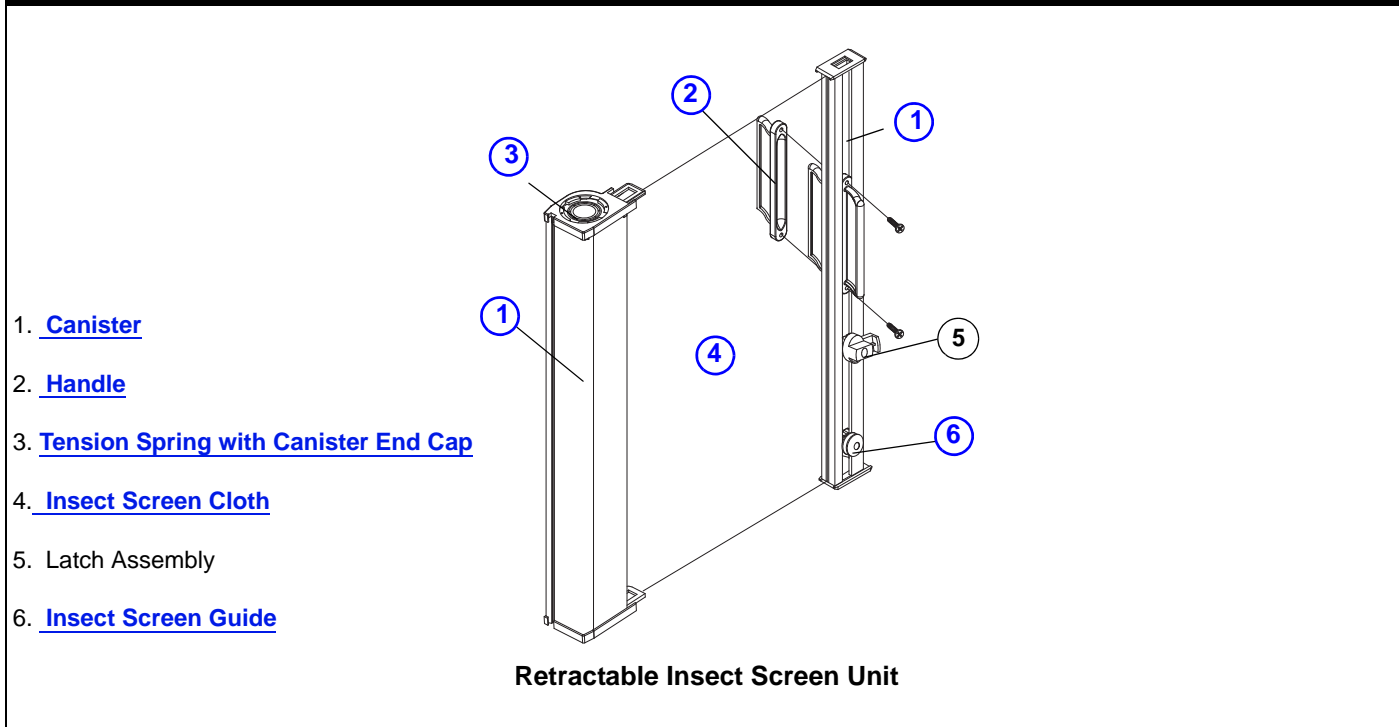

Insect Screen - Retractable (August 2003 to May 2007)

Note: Use current as replacement.	Unit No.	White	Terratone®	Sandstone
	GD5068	N/A	N/A	N/A
	GD50611	N/A	N/A	N/A
	GD5080	N/A	N/A	N/A
	GD5068	N/A	N/A	N/A
	GD50611	N/A	N/A	N/A
	GD5080	N/A	N/A	N/A
	GD5068	N/A	N/A	N/A
	GD50611	N/A	N/A	N/A
	GD5080	N/A	N/A	N/A

Retractable Insect Screen Parts / Vintage (Prior to June 2007)

Track with Screws - Top / Retractable Insect Screen (August 2003 to May 2007)					
	Unit No.	White	Terratone®	Sandtone	Forest Green
	GD50	2573142	2652841	0912647	1262885
	GD60	2573144	2652843	0912649	1262887
	GD80	2573145	2652844	0912650	1262888

Frenchwood® Gliding Doors (1987 to Present)

2-Panel, 4-Panel, and Stationary

Insect Screens

Track with Screws - Bottom / Retractable Insect Screen (August 2003 to May 2007)		
	Unit No.	Order No.
	GD50	2573138
	GD60	2573140
	GD80	2573141

Track Filler with Sill Sweep - Bottom / Retractable Insect Screen (August 2003 to May 2007)		
	Unit No.	Order No.
	GD50	2573146
	GD60	2573148
	GD80	2573149

Retractable Slide Bar - Retractable Insect Screen (August 2003 to May 2007)					
	Unit No.	White	Terratone®	Sandtone	Forest Green
	GD68	2573133	2652835	0912642	1262880
	GD611	2573134	2652836	0912643	1262881
	GD80	2573135	2652837	0912644	1262882

Canister - Retractable Insect Screen (August 2003 to May 2007) Ref. No. 1 page 46					
	Unit No.	White	Terratone®	Sandtone	Forest Green
	GD68	2573130	2652832	0912639	1262877
	GD611	2573131	2652833	0912640	1262878
	GD80	2573132	2652834	0912641	1262879

Cloth with Core - Retractable Insect Screen (August 2003 to May 2007) Ref. No. 4 page 46		
	Unit No.	Order No.
	GD68	2573151
	GD611	2573152
	GD80	2573153

Handle with Screws - Inside / Retractable Insect Screen (August 2003 to May 2007) Ref. No. 2 page 46		
	Color	Order No.
	White	2573136
	Terratone®	2652839
	Sandtone	0912646
	Forest Green	1262884

Insect Screens

Handle with Screws - Outside/ Retractable Insect Screen (August 2003 to May 2007) Ref. No. 2 page 46		
	Color	Order No.
	White	2562838
	Terratone®	2652838
	Sandtone	0912645
	Forest Green	1262883

Retainer with Screws - Retractable Insect Screen (August 2003 to May 2007)		
	Color	Order No.
	White	2573154
	Terratone®	2652845
	Sandtone	0912651
	Forest Green	1262889

End Cap - Canister / Retractable Insect Screen (August 2003 to May 2007) Ref. No. 3 page 46		
	Color	Order No.
	White	2573118
	Terratone®	2652831
	Sandtone	0912638
	Forest Green	1262876

Magnet - Slide Bar/ Retractable Insect Screen (Pair) (August 2003 to May 2007)	
	Order No.
	2573137

Tension Spring Assembly - Retractable Insect Screen (August 2003 to May 2007) Ref. No. 3 page 46		
	Unit No.	Order No.
		FWG80

Retainer Assembly - Bottom Cassette / Retractable Insect Screen (August 2003 to May 2007)	
	Order No.
	2573155

Screw - Anchor / Retractable Insect Screen (August 2003 to May 2007)	
	Order No.
	2573156

Frenchwood® Gliding Doors (1987 to Present)

2-Panel, 4-Panel, and Stationary

Insect Screens

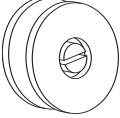
Guide- Insect Screen / Retractable (August 2003 to May 2007) Ref. No. 6 page 46			
		White	Gray
		2573369	N/A

End Cap - Slide Bar / Retractable Insect Screen (August 2003 to May 2007)	
	Order No.
	2573123

Grilles

Interior Grilles - Colonial

Note:

See [Accessory Guide 0005285](#). See [Interior Grille Installation Video](#). Grilles include fasteners.

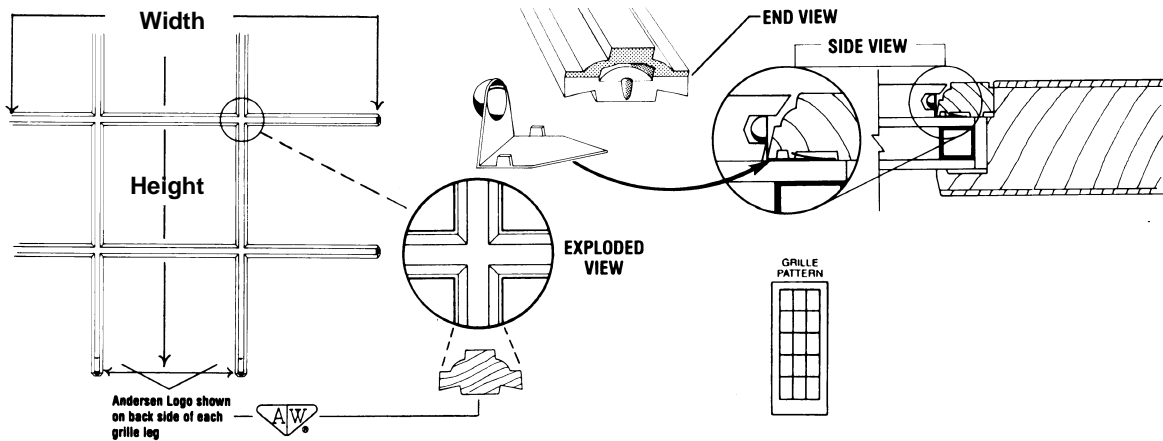

Frenchwood® Gliding Interior Grilles - 7/8" Wood - Colonial

Note:

Interior removable grilles for custom sized doors are made to order. Product ID label is located on top edge of operating panel.

To order, state:

1. Description of part (Interior Grille)
2. Quantity
3. Product ID
4. Options Desired (if different than original product)

Interior Grille - Colonial / 7/8" Wood / Maple Interior

Unit No.	Lite Pattern	Dimensions	Maple Interior/ White Exterior	Maple Interior/ Terratone® Exterior	Maple Interior/ Sandtone Exterior	Maple Interior/ Forest Green Exterior
FWG2668	3W x 5H	21 7/16 × 63 7/16	2565419	2650419	0910202	1262513
FWG26611	3W x 5H	21 7/16 × 66 5/16	2565405	2650415	0910214	1262516
FWG2680	3W x 6H	21 7/16 × 79 7/16	2565430	2650430	0910222	1262519
FWG3068	3W x 5H	27 7/16 × 63 7/16	2565420	2650418	0910204	1262514
FWG30611	3W x 5H	27 7/16 × 66 5/16	2565406	2650416	0910215	1262517
FWG3080	3W x 6H	27 7/16 × 79 7/16	2565432	2650432	0910224	1262520
FWG4068	4W x 5H	39 7/16 × 63 7/16	2565422	2650420	0910206	1262515
FWG40611	4W x 5H	39 7/16 × 66 5/16	2565407	2650417	0910216	1262518
FWG4080	4W x 6H	39 7/16 × 79 7/16	2565434	2650434	0910226	1262521

Frenchwood® Gliding Doors (1987 to Present)

2-Panel, 4-Panel, and Stationary

Grilles

Interior Grille - Colonial / 7/8" Wood / Oak Interior						
Unit No.	Lite Pattern	Dimensions	Oak Interior/ White Exterior	Oak Interior/ Terratone® Exterior	Oak Interior/ Sandtone Exterior	Oak Interior/ Forest Green Exterior
FWG2668	3W x 5H	21 7/16 x 63 7/16	2565459	2650445	0910233	1262522
FWG26611	3W x 5H	21 7/16 x 66 5/16	2565463	2650449	0910237	1262525
FWG2680	3W x 6H	21 7/16 x 79 7/16	2565466	2650452	0910240	1262528
FWG3068	3W x 5H	27 7/16 x 63 7/16	2565461	2650447	0910235	1262523
FWG30611	3W x 5H	27 7/16 x 66 5/16	2565464	2650450	0910238	1262526
FWG3080	3W x 6H	27 7/16 x 79 7/16	2565467	2650453	0910241	1262529
FWG4068	4W x 5H	39 7/16 x 63 7/16	2565462	2650448	0910236	1262524
FWG40611	4W x 5H	39 7/16 x 66 5/16	2565465	2650451	0910239	1262527
FWG4080	4W x 6H	39 7/16 x 79 7/16	2565468	2650454	0910242	1262530

Interior Grille - Colonial / 7/8" Wood / Prefinished Interior White				
	Unit No.	Lite Pattern	Dimensions	Prefinished Interior White/ White Exterior
	FWG2668	3W x 5H	21 7/16 x 63 7/16	2565469
	FWG26611	3W x 5H	21 7/16 x 66 5/16	2565472
	FWG2680	3W x 6H	21 7/16 x 79 7/16	2565475
	FWG3068	3W x 5H	27 7/16 x 63 7/16	2565470
	FWG30611	3W x 5H	27 7/16 x 66 5/16	2565473
	FWG3080	3W x 6H	27 7/16 x 79 7/16	2565476
	FWG4068	4W x 5H	39 7/16 x 63 7/16	2565471
	FWG40611	4W x 5H	39 7/16 x 66 5/16	2565474
	FWG4080	4W x 6H	39 7/16 x 79 7/16	2565477

Grilles

Interior Grilles - Prairie A

Note:

See [Accessory Guide 0005285](#).

Note:

Interior removable grilles for custom sized doors are made to order. Product ID label is located on top edge of operating panel.

To order, state:

1. Description of part (Interior Grille)
2. Quantity
3. Product ID
4. Options Desired (if different than original product)

Interior Grille - Prairie A / 7/8" Wood / Maple Interior

Unit No.	Lite Pattern	Dimensions	Maple Interior/ White Exterior	Maple Interior/ Terratone® Exterior	Maple Interior/ Sandtone Exterior	Maple Interior/ Forest Green Exterior
FWG2668	3W x 5H	21 7/16 x 63 7/16	2511146	2652603	0930922	1265938
FWG26611	3W x 5H	21 7/16 x 66 5/16	2511145	2652602	0930921	1265939
FWG2680	3W x 6H	21 7/16 x 79 7/16	2511147	2652604	0930923	1265940
FWG3068	3W x 5H	27 7/16 x 63 7/16	2511149	2652606	0930925	1265941
FWG30611	3W x 5H	27 7/16 x 66 5/16	2511148	2652605	0930924	1265942
FWG3080	3W x 6H	27 7/16 x 79 7/16	2511150	2652607	0930926	1265943
FWG4068	4W x 5H	39 7/16 x 63 7/16	2511152	2652609	0930928	1265944
FWG40611	4W x 5H	39 7/16 x 66 5/16	2511151	2652608	0930927	1265945
FWG4080	4W x 6H	39 7/16 x 79 7/16	2511153	2652610	0930929	1265946

Interior Grille - Prairie A / 7/8" Wood / Oak Interior

Unit No.	Lite Pattern	Dimensions	Oak Interior/ White Exterior	Oak Interior/ Terratone® Exterior	Oak Interior/ Sandtone Exterior	Oak Interior/ Forest Green Exterior
FWG2668	3W x 5H	21 7/16 x 63 7/16	2511189	2652646	0930965	1265947
FWG26611	3W x 5H	21 7/16 x 66 5/16	2511188	2652645	0930964	1265948
FWG2680	3W x 6H	21 7/16 x 79 7/16	2511190	2652647	0930966	1265949
FWG3068	3W x 5H	27 7/16 x 63 7/16	2511192	2652649	0930968	1265950
FWG30611	3W x 5H	27 7/16 x 66 5/16	2511191	2652648	0930967	1265951
FWG3080	3W x 6H	27 7/16 x 79 7/16	2511193	2652650	0930969	1265952
FWG4068	4W x 5H	39 7/16 x 63 7/16	2511195	2652652	0930971	1265953
FWG40611	4W x 5H	39 7/16 x 66 5/16	2511194	2652651	0930970	1265954
FWG4080	4W x 6H	39 7/16 x 79 7/16	2511196	2652653	0930972	1265955

Frenchwood® Gliding Doors (1987 to Present)

2-Panel, 4-Panel, and Stationary

Grilles

Interior Grille - Prairie A / 7/8" Wood / Prefinished Interior White

	Unit No.	Lite Pattern	Dimensions	Prefinished Interior White/ White Exterior
	FWG2668	3W x 5H	21 ⁷ / ₁₆ × 63 ⁷ / ₁₆	2511103
	FWG26611	3W x 5H	21 ⁷ / ₁₆ × 66 ⁵ / ₁₆	2511102
	FWG2680	3W x 6H	21 ⁷ / ₁₆ × 79 ⁷ / ₁₆	2511104
	FWG3068	3W x 5H	27 ⁷ / ₁₆ × 63 ⁷ / ₁₆	2511106
	FWG30611	3W x 5H	27 ⁷ / ₁₆ × 66 ⁵ / ₁₆	2511105
	FWG3080	3W x 6H	27 ⁷ / ₁₆ × 79 ⁷ / ₁₆	2511107
	FWG4068	4W x 5H	39 ⁷ / ₁₆ × 63 ⁷ / ₁₆	2511109
	FWG40611	4W x 5H	39 ⁷ / ₁₆ × 66 ⁵ / ₁₆	2511108
	FWG4080	4W x 6H	39 ⁷ / ₁₆ × 79 ⁷ / ₁₆	2511110

Grille Fastener

Grille Fastener (1989)

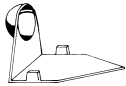
		Order No.
		1974314

Notch Grille Fastener - Interior Grille

		Color	Order No.
		White	1974310
		Terratone®	2601210
		Forest Green	9046244

Interior Grille Installation and Marking Tool

		Order No.
		1974315

Hardware

Half Trim Set Kits - Interior

Note:

Interior half trim sets are available for Newbury®, Covington™, Encino®, Yuma®, Anvers®, Whitmore®, Tribeca®, and Albany Hardware.

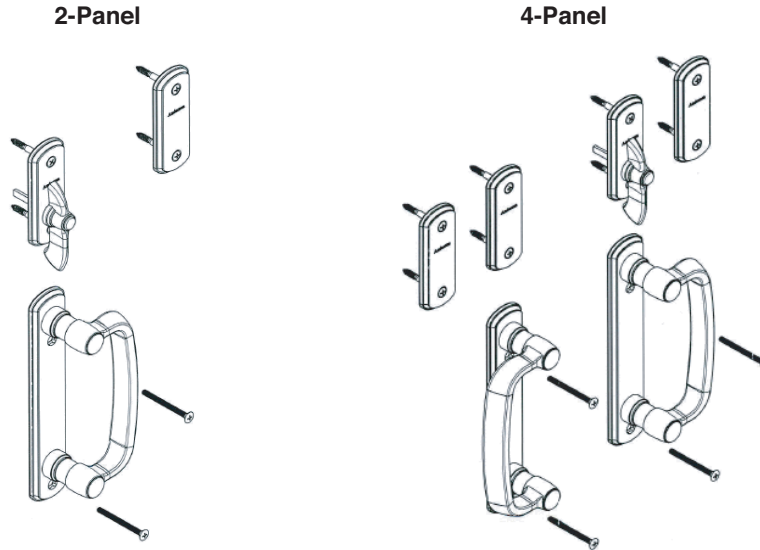

RH Handle, Albany Style Shown

Covington™, Newbury®, Encino® and Yuma® Styles

Handle Assembly Parts	2-Panel	4-Panel
Handle, RH Gliding*	1	1
Handle, LH Gliding*	N/A	1
Shank, Gliding	1	3
Plate, Escutcheon, Gliding	1	1
Rubber Washer	2	4
Screw, #10-24 UNC x 1-5/8, PH FL, MACH	2	4
Other Parts		
Screw, #8 x 2" Oval Head Threaded Bolt	2	4
Retain Ring	1	1
Wave Washer	1	1
Plate, Thumb Latch Escutcheon	1	1
Tail Piece	1	1
Lever, Thumb Latch	1	1
Pin	1	1
Ball Bearing - Delrin	3	3
Screw, #8 x 1 3/4" Oval Head Screw	2	4
Plate Trim	1	2
Plate, Escutcheon Cover	N/A	1

* All 2-panel kits contain a RH handle/escutcheon assembly. Convert RH handle assembly for LH installations.

Frenchwood® Gliding Doors (1987 to Present)

2-Panel, 4-Panel, and Stationary

Hardware

Whitmore®, Anvers®, and Albany Styles		
Handle Assembly Parts	2-Panel	4-Panel
Handle, RH Gliding*	1	1
Handle, LH Gliding*	N/A	1
Plate, Escutcheon, Gliding	1	2
Rubber Washer	2	4
Screw, #8 x 2" Oval Head Threaded Bolt	2	4
Other Parts		
Retain Ring	1	1
Wave Washer	1	1
Plate, Thumb Latch Escutcheon	1	1
Tail Piece	1	1
Lever, Thumb Latch	1	1
Pin	1	1
Ball Bearing - Delrin	3	3
Screw, #8 x 1 3/4" Oval Head Screw	2	4
Plate, Escutcheon Cover	N/A	3
* All 2-panel kits contain a RH handle/escutcheon assembly. Convert RH handle assembly for LH installations.		

Hardware

Half Trim Set Kits - Exterior

Note:

Exterior half trim sets are available for Newbury®, Covington™, Encino®, Yuma®, Anvers®, Whitmore®, Tribeca®, and Albany Hardware.

2-Panel

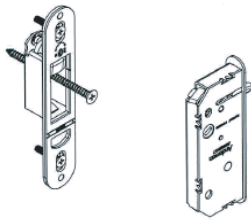

4-Panel

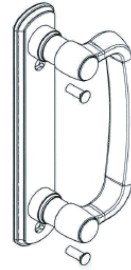
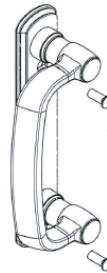
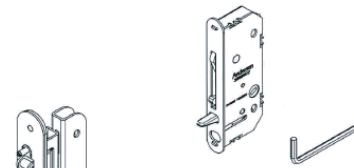

RH Handle, Albany Style Shown

Newbury®, Covington™, Encino®, Yuma®, Anvers®, Whitmore®, and Albany Styles

Note:

Tribeca® exterior kit does not include tapped studs.

Sets include:

	2-Panel	4-Panel
Handle Assembly Parts		
Handle, RH Gliding*	1	1
Handle, LH Gliding*	N/A	1
Shank, Gliding	2	4
Plate, Escutcheon, Gliding	1	2
Rubber Washer	2	4
Screw, #10-24 UNC x 1-5/8, PH FL MACH	2	4
Stud Tapped	2	4
Other Parts		
Reachout Lock Assembly	1	1
Receiver, 2-panel	1	N/A
Receiver, 4-panel	N/A	1
Screw, #8 x 7/8" Machine Screw	2	N/A
Screw, #10 x 3" Flat Head Security Screw	1	N/A
9/64, Allen Wrench	N/A	1

* All 2-panel kits contain a RH handle/escutcheon assembly. Convert RH handle assembly for LH installations.

Frenchwood® Gliding Doors (1987 to Present)

2-Panel, 4-Panel, and Stationary

Hardware

Hardware - Tribeca®

Note:

See [Accessory Guide 0005414](#).

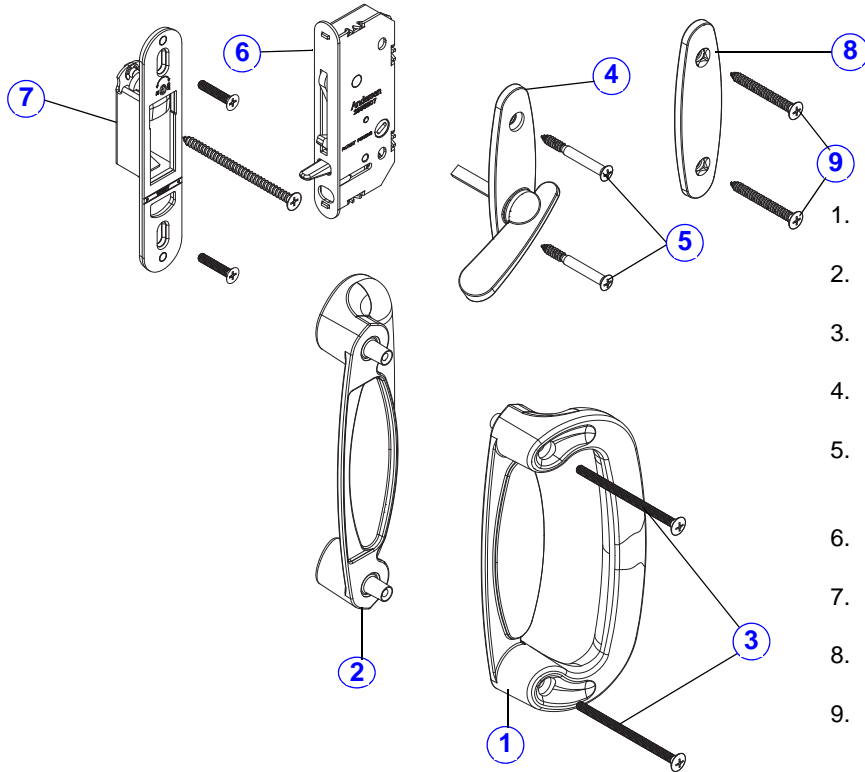

1. [Interior Handle](#)
2. [Exterior Handle](#)
3. [#8 x 2 11/16" Oval Head Bolt](#)
4. [Latch Lever](#)
5. [#10-16 X 1-3/4", PH W/#8 Oval Head, Type AB Screw](#)
6. [Reachout Lock Assembly-2 panel](#)
7. [Latch Receiver-2 panel](#)
8. [Cover Plate](#)
9. [#10 x 1 3/4" Oval Head Wood Screw](#)

Trim Set Hardware - Tribeca® / Interior and Exterior

	Panels	Finish	Order No.
	2	Stone	2565696
		White	2565694
	4	Stone	2565697
		White	2565695

Trim Set Hardware - Tribeca® / Interior

	Panels	Finish	Order No.
	2	Stone	2562078
		White	2562076
	4	Stone	2562079
		White	2562077

Trim Set Hardware - Tribeca® / Exterior

	Panels	Finish	Order No.
	2	Stone	2562034
		White	2562032
	4	Stone	2562035
		White	2562033

Hardware

Handle - Tribeca® / Interior Ref. No. 1 page 57		
Note: Handles are sold assembled with escutcheon plates.	Finish	Order No.
	Stone	2573603
	White	2573602
Handle - Tribeca® / Exterior Ref. No. 2 page 57		
Note: Handles are sold assembled with escutcheon plates.	Finish	Order No.
	Stone	2573605
	White	2573604
Thumb Latch/Latch Lever - Tribeca® / Interior Lock No.4 page 57		
Note: Ships with fasteners. See Latch Lever Replacement Video .	Finish	Order No.
	Stone	2573611
	White	2573609
Cover Plate - Tribeca® Ref. No.8 page 57		
Note: Ships with fasteners.	Finish	Order No.
	Stone	2573623
	White	2573621

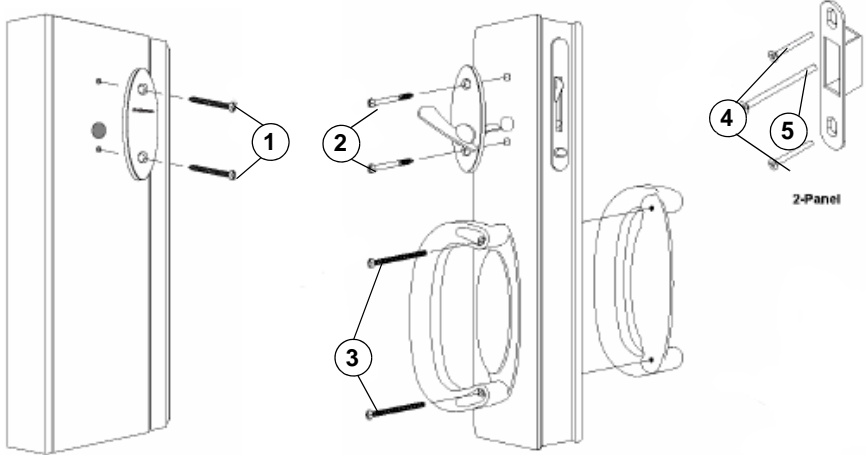
Screw Package - Trim Set / Tribeca® (2005 to Present) Ref. No.3,5 & 9 page 57			
			
Ref. No.	Package includes:	Finish	Order No.
1	2 - screws, #10 x 1 3/4" oval head wood	Stone	2573468
2	2 - screws, #10 -16 x 1 3/4" PH #8 oval head	White	2573467
3	2 - screws, #8 - 32 UNC x 2 11/16" PH #10 oval HD mach		
4	2 - screws, #8 - 32 UNC x 7/8" PH FL mach		
5	1 - screw, #10 x 3" flathead sheet metal		

Screw Package - Trim Set / Tribeca® (2004 to 2005)		
	Finish	Order No.
	Stone	2579769
	White	2579768

Frenchwood® Gliding Doors (1987 to Present)

2-Panel, 4-Panel, and Stationary

Hardware

Lock Assembly with Keys - Tribeca®

Note:

Lock assemblies will have two (2) cut keys and two (2) 2 1/4" bolts.

Order keyed alike exterior locks with the number of locks need.

See [Accessory Guide 0005196](#).

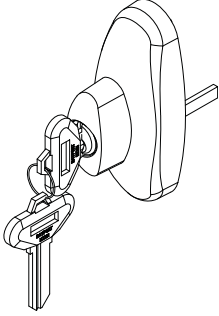
		Finish	Lock Assembly		Keyed Alike	
			Left	Right	Left	Right
		Stone	2573069	2573079	9056179	9056181
		White	2573068	2573078	9056178	9056180

Lock Assembly with Keys - Tribeca® / Exterior/ Keyed Alike Right-Hand and Left-Hand

Note:

Contains 1 right hand and 1 left hand assembly

Finish	Order No.
Stone	9056204
White	9056205

Key Cylinder - Tribeca®

Note:

Tribeca® lock assembly has used a 6 pin cylinder since January of 2004.

Glass dates do not always represent the vintage of the lock assembly or the replacement key cylinder needed.

6 pin replacement cylinder are found on [page 85](#).

5 pin replacement cylinder are found on [page 89](#).

Bolt Package for Exterior Lock - Tribeca® (Pair) (2005 to Present)

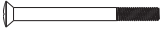
		Length	Finish	Order No.
		2 1/4"	Stone	2573648
		2 1/4"	White	2573647

Bolt Package for Exterior Lock - Tribeca® (Pair) (2004 to 2005)

		Length	Finish	Order No.
		2 3/4"	Stone	2573607
		2 3/4"	White	2573606

Lock Housing

Note:

Replace with entire exterior lock assembly.

Stone	White
N/A	

Hardware

Hardware - Anvers®

Note:

See [Accessory Guide 0005414](#).

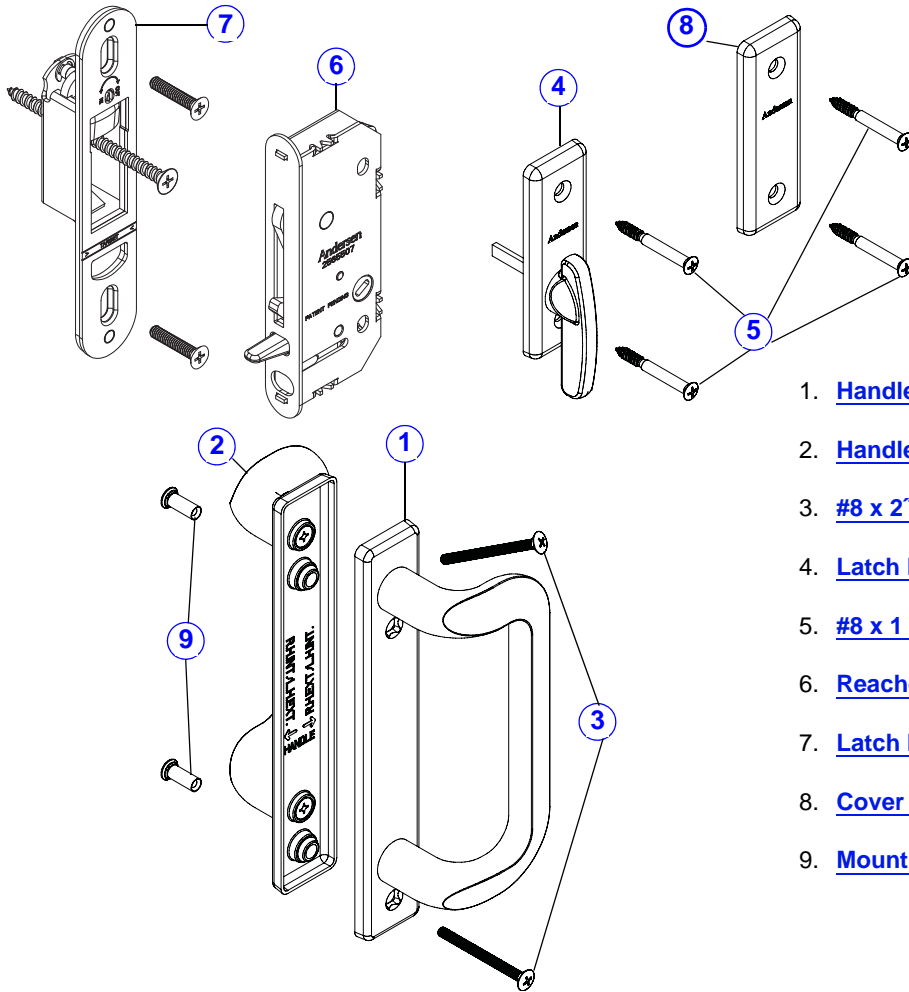

1. [Handle RH Interior/LH Exterior](#)
2. [Handle LH Interior/RH Exterior](#)
3. [#8 x 2" Oval Head Threaded Bolt](#)
4. [Latch Lever](#)
5. [#8 x 1 3/4" Oval Head Screw](#)
6. [Reachout Lock Assembly-2 panel](#)
7. [Latch Receiver-2 panel](#)
8. [Cover Plate](#)
9. [Mounting Stud](#)

Anvers® Gliding Patio Door Hardware - 2-Panel Trim Set

Trim Set Hardware - Anvers® / Interior and Exterior

Panels	Finish	Order No.
2	Bright Brass	2565539
	Oil Rubbed Bronze	2565543
	Satin Nickel	2565541
4	Bright Brass	2565540
	Oil Rubbed Bronze	2565544
	Satin Nickel	2565542

Frenchwood® Gliding Doors (1987 to Present)

2-Panel, 4-Panel, and Stationary

Hardware

Trim Set Hardware - Anvers® / Interior			
	Panels	Finish	Order No.
	2	Bright Brass	2562092
		Oil Rubbed Bronze	2562103
		Satin Nickel	2562109
	4	Bright Brass	2562093
		Oil Rubbed Bronze	2562112
		Satin Nickel	2562118

Trim Set Hardware - Anvers® / Exterior			
	Panels	Finish	Order No.
	2	Bright Brass	2562048
		Oil Rubbed Bronze	2562066
		Satin Nickel	2562072
	4	Bright Brass	2562049
		Oil Rubbed Bronze	2562067
		Satin Nickel	2562073

Handle - Anvers® Ref. No. 1 & 2 page 60			
Note: Handles are sold assembled with escutcheon plates.	Finish	Left Interior/ Right Exterior	Right Interior/ Left Exterior
	Bright Brass	2573219	2573220
	Oil Rubbed Bronze	2573221	2573222
	Satin Nickel	2573223	2573224

Thumb Latch / Latch Lever - Anvers® / Interior Lock Ref. No. 4 page 60		
Note: Ships with fasteners. See Latch Lever Replacement Video .	Finish	Order No.
	Bright Brass	2573239
	Oil Rubbed Bronze	2573240
	Satin Nickel	2573241

Cover Plate with Screws - Anvers® Ref. No. 8 page 60		
Note: Ships with fasteners. Use one cover plate on two-panel units; three cover plates on four-panel units	Finish	Order No.
	Bright Brass	2573249
	Oil Rubbed Bronze	2573250
	Satin Nickel	2573251

Screw Package - Trim Set / Anvers®
Note: Screw package is included in the shared hardware section page 84 .

Hardware

Lock Assembly with Keys - Anvers®

Note:

Lock assemblies will have two (2) cut keys and two (2) 2 1/4" bolts.
Order keyed alike exterior locks with the number of locks need.
See [Accessory Guide 0005196](#).

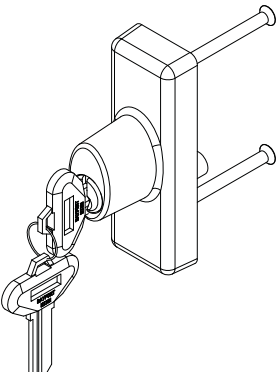
	Finish	Lock Assembly		Keyed Alike	
		Left	Right	Left	Right
	Bright Brass	2573269	2573090	9056172	9056175
	Oil Rubbed Bronze	2573270	2573091	9056173	9056176
Satin Nickel	2573271	2573092	9056174	9056177	

Lock Assembly with Keys - Anvers® / Exterior/ Keyed Alike Right-Hand and Left-Hand

Note:

Contains 1 right hand and 1 left hand assembly

Finish	Order No.
Bright Brass	9056201
Oil Rubbed Bronze	9056202
Satin Nickel	9056203

Key Cylinder - Anvers®

Note:

Anvers® lock assembly uses a 6 pin replacement cylinder are found on [page 85](#).

Bolt Package - Anvers® / Exterior Lock

Note:

Bolt package is included in the current lock parts section [page 85](#).

Lock Housing - Anvers® / Exterior

Note:

Replace with complete exterior lock assembly.

Finish	Order No.
Bright Brass	N/A
Oil Rubbed Bronze	N/A
Satin Nickel	N/A

Frenchwood® Gliding Doors (1987 to Present)

2-Panel, 4-Panel, and Stationary

Hardware

Hardware - Newbury®

Note:

See [Accessory Guide 0005414](#).

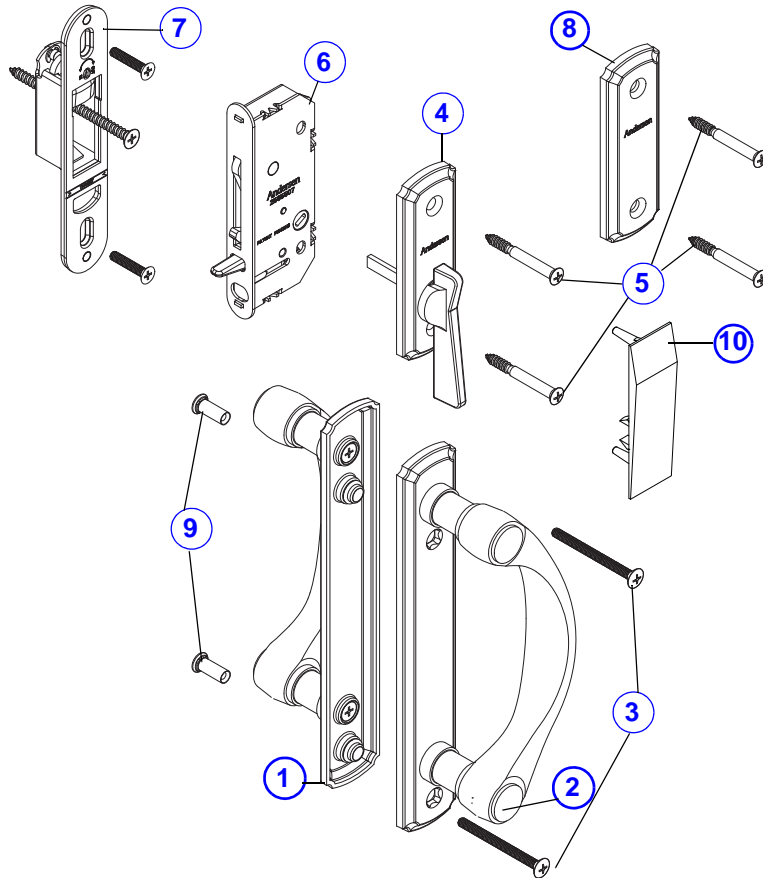

1. [Handle RH Interior/LH Exterior](#)
2. [Handle LH Interior/RH Exterior](#)
3. [#8 x 2" Oval Head Threaded Bolt](#)
4. [Latch Lever](#)
5. [#8 x 1 3/4" Oval Head Screw](#)
6. [Reachout Lock Assembly-2 panel](#)
7. [Latch Receiver-2 panel](#)
8. [Cover Plate \(4-Panel Doors\)](#)
9. [Mounting Stud](#)
10. [Trim Plate \(2-Panel Doors\)](#)

Newbury® Gliding Patio Door Hardware - Panel Trim Set

Trim Set Hardware - Newbury® / Interior and Exterior

	Panels	Finish	Order No.
	2	Antique Brass	2565686
		Brushed Chrome	2579748
		Chrome	2565688
		H.P. Brass	2565684
		Oil Rubbed Bronze	2579744
		Satin Nickel	2579435
	4	Antique Brass	2565687
		Brushed Chrome	2579749
		Chrome	2565689
		H.P. Brass	2565685
		Oil Rubbed Bronze	2579745
		Satin Nickel	2579436

Hardware

Trim Set Hardware - Newbury® / Interior			
	Panels	Finish	Order No.
	2	Antique Brass	2562082
		Brushed Chrome	2562086
		Chrome	2562084
		H.P. Brass	2562080
		Oil Rubbed Bronze	2562088
		Satin Nickel	2562090
	4	Antique Brass	2562081
		Brushed Chrome	2562085
		Chrome	2562087
		H.P. Brass	2562083
		Oil Rubbed Bronze	2562089
		Satin Nickel	2562091

Trim Set Hardware - Newbury® / 2-Panel / Exterior			
	Panels	Finish	Order No.
	2	Antique Brass	2562036
		Brushed Chrome	2562040
		Chrome	2562042
		H.P. Brass	2562038
		Oil Rubbed Bronze	2562044
		Satin Nickel	2562046
	4	Antique Brass	2562037
		Brushed Chrome	2562041
		Chrome	2562043
		H.P. Brass	2562039
		Oil Rubbed Bronze	2562045
		Satin Nickel	2562047

Handle - Newbury® Ref. No. 1 and 2 page 63			
Note: Handles are sold assembled with escutcheon plates.	Finish	Left Interior/ Right Exterior	Right Interior/ Left Exterior
	Antique Brass	2573593	2573596
	Brushed Chrome	2579942	2579944
	Chrome	2573592	2573595
	H.P. Brass	2573594	2573597
	Oil Rubbed Bronze	2579941	2579943
	Satin Nickel	2579433	2579434

Frenchwood® Gliding Doors (1987 to Present)

2-Panel, 4-Panel, and Stationary

Hardware

Thumb Latch - Newbury® / Inside Lock Ref. No. 4 page 63		
Note: Ships with fasteners. See Latch Lever Replacement Video .	Finish	Order No.
	Antique Brass	2573599
	Brushed Chrome	2579950
	Chrome	2573598
	H.P. Brass	2573601
	Oil Rubbed Bronze	2579949
	Satin Nickel	2579425
Cover Plate with Screws - Newbury® / 4-Panel Ref. No. 8 page 63		
Note: Ships with fasteners.	Finish	Order No.
	Antique Brass	2573507
	Brushed Chrome	2579954
	Chrome	2573509
	H.P. Brass	2573543
	Oil Rubbed Bronze	2579953
	Satin Nickel	2579432
Screw Package - Trim Set / Newbury®		
Note: Screw package is included in the shared hardware section page 84 .		

Hardware

Lock Assembly with Keys - Newbury®

Note:

Lock assemblies will have two (2) cut keys and two (2) 2 1/4" bolts.

Order keyed alike exterior locks with the number of locks need.

See [Accessory Guide 0005196](#).

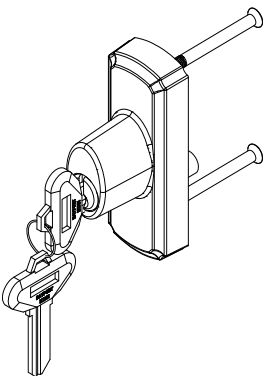
	Finish	Lock Assembly		Keyed Alike	
		Left	Right	Left	Right
	Antique Brass	2573071	2573081	9056152	9056158
	Brushed Chrome	2573075	2573085	9056153	9056159
	Chrome	2573072	2573082	9056154	9056160
	H.P. Brass	2573070	2573080	9056155	9056161
	Oil Rubbed Bronze	2573074	2573084	9056156	9056162
	Satin Nickel	2573073	2573083	9056157	9056163

Lock Assembly with Keys - Newbury®/ Exterior/ Keyed Alike Right-Hand and Left-Hand

Note:

Contains 1 right hand and 1 left hand assembly

Finish	Order No.
Antique Brass	9056206
Brushed Chrome	9056207
Chrome	9056208
H.P. Brass	9056209
Oil Rubbed Bronze	9056210
Satin Nickel	9056211

Key Cylinder - Newbury®

Note:

Newbury® lock assembly has used a 6 pin cylinder since January of 2004.

Glass dates do not always represent the vintage of the lock assembly or the replacement key cylinder needed.

6 pin replacement cylinder are found on [page 85](#).

5 pin replacement cylinder are found on [page 89](#).

Bolt Package - Newbury® / Exterior Lock

Note:

Bolt package is included in the shared lock parts section [page 85](#).

Lock Housing - Newbury® / Exterior

Note:

Replace with complete exterior lock assembly.

Finish	Order No.
Antique Brass	N/A
Brushed Chrome	
Chrome	
H.P. Brass	
Oil Rubbed Bronze	
Satin Nickel	

Frenchwood® Gliding Doors (1987 to Present)

2-Panel, 4-Panel, and Stationary

Hardware

Hardware - Covington™

Note:

See [Accessory Guide 0005414](#).

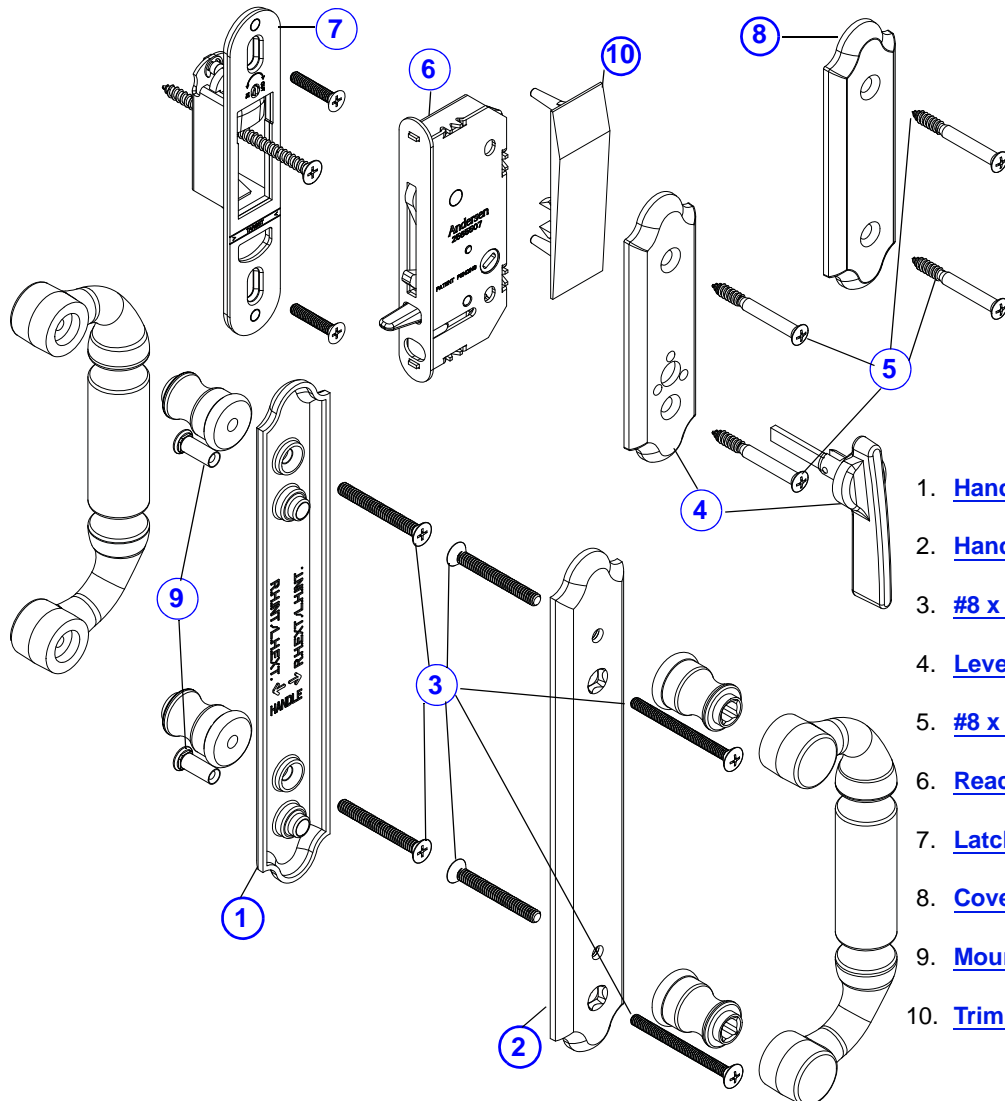

Note:

Interior/Exterior handles and thumb latch come assembled.

1. [Handle RH Interior/LH Exterior](#)
2. [Handle LH Interior/RH Exterior/](#)
3. [#8 x 2" Oval Head Threaded Bolt](#)
4. [Lever Latch](#)
5. [#8 x 1 3/4" Oval Head Screw](#)
6. [Reachout Lock Assembly-2 panel](#)
7. [Latch Receiver-2 panel](#)
8. [Cover Plate \(4-Panel Doors\)](#)
9. [Mounting Stud](#)
10. [Trim Plate \(2-Panel Doors\)](#)

Covington™ Gliding Patio Door Hardware - 2-Panel Trim Set

Trim Set Hardware - Covington™ / Interior and Exterior

	Panels	Finish	Order No.
	2	Antique Brass	2565563
		Bright Brass	2565561
		Oil Rubbed Bronze	2565567
	4	Antique Brass	2565564
		Bright Brass	2565562
		Oil Rubbed Bronze	2565568

Hardware

Trim Set Hardware - Covington™ / Interior			
	Panels	Finish	Order No.
	2	Antique Brass	2562098
		Bright Brass	2562094
		Oil Rubbed Bronze	2562105
	4	Antique Brass	2562099
		Bright Brass	2562095
		Oil Rubbed Bronze	2562114

Trim Set Hardware - Covington™ / Exterior			
	Panels	Finish	Order No.
	2	Antique Brass	2562054
		Bright Brass	2562050
		Oil Rubbed Bronze	2562068
	4	Antique Brass	2562055
		Bright Brass	2562051
		Oil Rubbed Bronze	2562069

Handle - Covington™ Ref. No. 1 & 2 page 67			
Note: Handles are sold assembled with escutcheon plates.	Finish	Left Interior/ Right Exterior	Right Interior/ Left Exterior
	Antique Brass	2573233	2573234
	Bright Brass	2573235	2573236
	Oil Rubbed Bronze	2573237	2573238

Thumb Latch/Latch Lever - Covington™ / Inside Lock Ref. No. 4 page 67		
Note: Ships with fasteners. See Latch Lever Replacement Video .	Finish	Order No.
	Antique Brass	2573246
	Bright Brass	2573247
	Oil Rubbed Bronze	2573248

Cover Plate with Screws - Covington™ / 4-Panel Ref. No. 8 page 67		
Note: Ships with fasteners.	Finish	Order No.
	Antique Brass	2573256
	Bright Brass	2573257
	Oil Rubbed Bronze	2573258

Screw Package - Trim Set / Covington™
Note: Screw package is included in the shared hardware section page 84 .

Frenchwood® Gliding Doors (1987 to Present)

2-Panel, 4-Panel, and Stationary

Hardware

Lock Assembly with Keys - Covington™

Note:

Lock assemblies will have two (2) cut keys and two (2) 2 1/4" bolts.

Order keyed alike exterior locks with the number of locks need.

See [Accessory Guide 0005196](#).

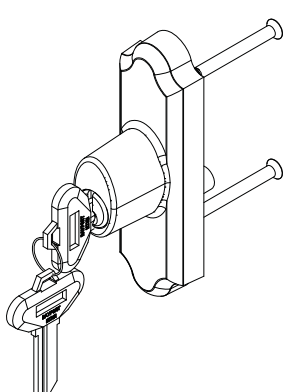
	Finish	Lock Assembly		Keyed Alike	
		Left	Right	Left	Right
	Antique Brass	2573276	2573097	9056149	9056146
	Bright Brass	2573277	2573098	9056150	9056147
Oil Rubbed Bronze	2573278	2573099	9056151	9056148	

Lock Assembly with Keys - Covington™ / Exterior/ Keyed Alike Right-Hand and Left-Hand

Note:

Contains 1 right hand and 1 left hand assembly

Finish	Order No.
Antique Brass	9056198
Bright Brass	9056199
Oil Rubbed Bronze	9056200

Key Cylinder - Covington™

Note:

Covington™ lock assembly uses a 6 pin replacement cylinder are found on [page 85](#).

Bolt Package - Covington™ / Exterior Lock

Note:

Bolt package is included in the shared lock parts section [page 85](#).

Lock Housing - Covington™ / Exterior

Note:

Replace with complete exterior lock assembly.

Finish	Order No.
Antique Brass	N/A
Bright Brass	
Oil Rubbed Bronze	

Hardware

Hardware - Whitmore®

Note:

See [Accessory Guide 0005414](#).

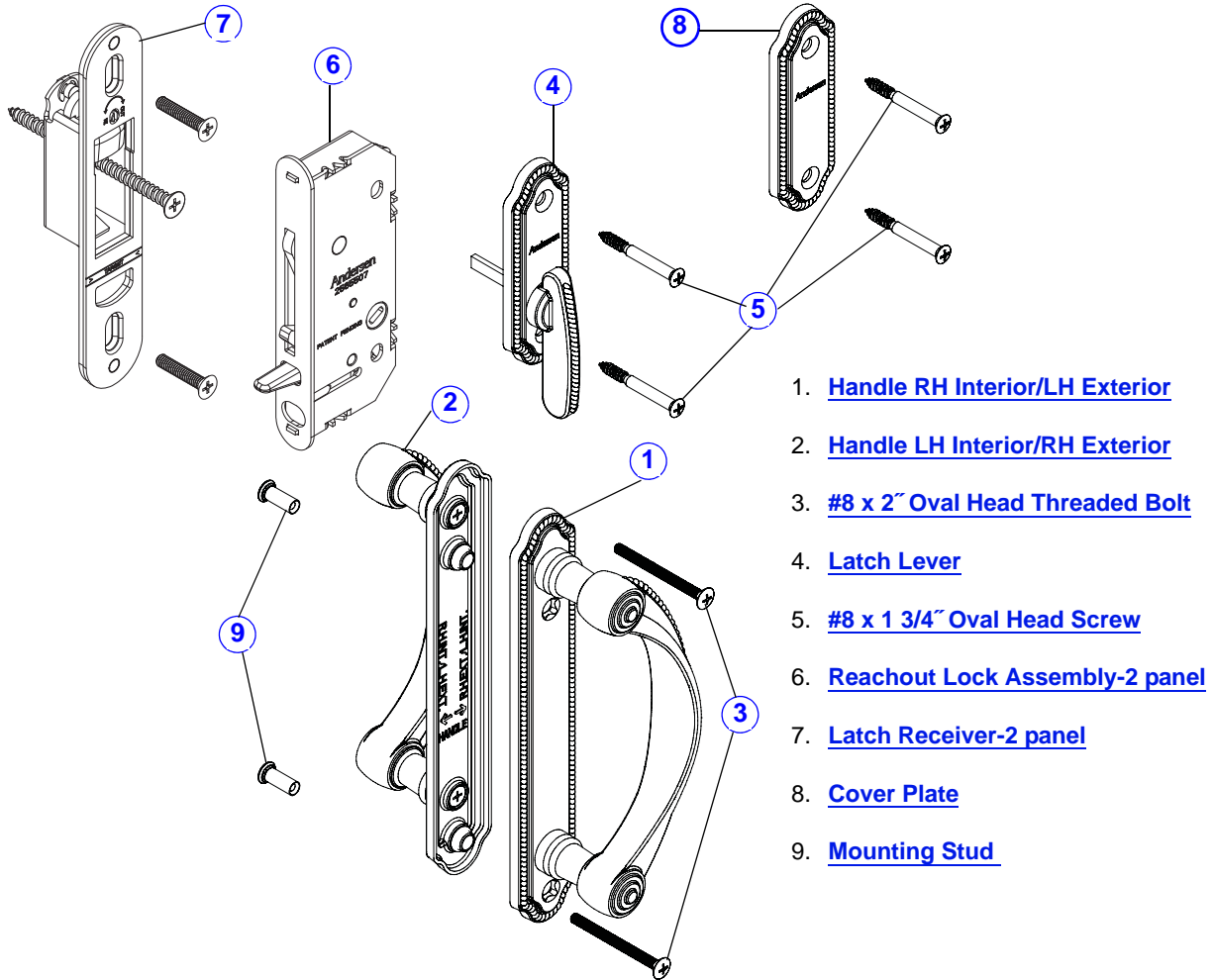

1. [Handle RH Interior/LH Exterior](#)
2. [Handle LH Interior/RH Exterior](#)
3. [#8 x 2" Oval Head Threaded Bolt](#)
4. [Latch Lever](#)
5. [#8 x 1 3/4" Oval Head Screw](#)
6. [Reachout Lock Assembly-2 panel](#)
7. [Latch Receiver-2 panel](#)
8. [Cover Plate](#)
9. [Mounting Stud](#)

Whitmore® Gliding Patio Door Hardware - 2-Panel Trim Set

Frenchwood® Gliding Doors (1987 to Present)

2-Panel, 4-Panel, and Stationary

Hardware

Trim Set Hardware - Whitmore®/ Interior and Exterior			
	Panels	Finish	Order No.
	2	Antique Brass	2565549
		Bright Brass	2565545
		Oil Rubbed Bronze	2565551
		Satin Nickel	2565547
	4	Antique Brass	2565550
		Bright Brass	2565546
		Oil Rubbed Bronze	2565552
		Satin Nickel	2565548

Trim Set Hardware - Whitmore® / Interior			
	Panels	Finish	Order No.
	2	Antique Brass	2562101
		Bright Brass	2562096
		Oil Rubbed Bronze	2562107
		Satin Nickel	2562111
	4	Antique Brass	2562102
		Bright Brass	2562097
		Oil Rubbed Bronze	2562116
		Satin Nickel	2562121

Trim Set Hardware - Whitmore® / Exterior			
	Panels	Finish	Order No.
	2	Antique Brass	2562056
		Bright Brass	2562052
		Oil Rubbed Bronze	2562070
		Satin Nickel	2562074
	4	Antique Brass	2562057
		Bright Brass	2562053
		Oil Rubbed Bronze	2562071
		Satin Nickel	2562075

Handle - Whitmore® Ref. No. 1 & 2 page 70			
Note: Handles are sold assembled with escutcheon plates.	Finish	Left Interior/ Right Exterior	Right Interior/ Left Exterior
	Antique Brass	2573225	2573226
	Bright Brass	2573227	2573228
	Oil Rubbed Bronze	2573229	2573230
	Satin Nickel	2573231	2573232

Hardware

Thumb Latch / Latch Lever - Whitmore® / Interior Lock Ref. No. 4 page 70		
Note: Ships with fasteners. See Latch Lever Replacement Video .	Finish	Order No.
	Antique Brass	2573242
	Bright Brass	2573243
	Oil Rubbed Bronze	2573244
	Satin Nickel	2573245

Cover Plate with Screws - Whitmore® / 4 Panel Ref. No. 8 page 70		
Note: Ships with fasteners. Use one cover plate on two-panel units; three cover plates on four-panel units.	Finish	Order No.
	Antique Brass	2573252
	Bright Brass	2573253
	Oil Rubbed Bronze	2573254
	Satin Nickel	2573255

Screw Package - Trim Set / Whitmore®		
Note: Screw package is included in the shared hardware section page 84 .		

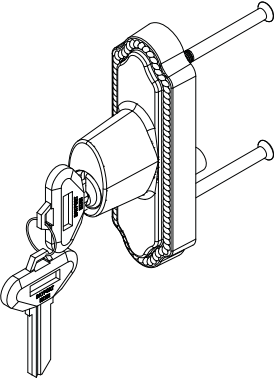
Lock Assembly with Keys - Whitmore® / Exterior					
Note: Lock assemblies will have two (2) cut keys and two (2) 2 1/4" bolts. Order keyed alike exterior locks with the number of locks need. See Accessory Guide 0005196 .					
	Finish	Lock Assembly		Keyed Alike	
		Left	Right	Left	Right
	Antique Brass	2573272	2573093	9056164	9056168
	Bright Brass	2573273	2573094	9056165	9056169
	Oil Rubbed Bronze	2573274	2573095	9056166	9056170
Satin Nickel	2573275	2573096	9056167	9056171	

Lock Assembly with Keys - Whitmore® / Exterior/ Keyed Alike Right-Hand and Left-Hand		
Note: Contains 1 right hand and 1 left hand assembly	Finish	Order No.
	Antique Brass	9056212
	Bright Brass	9056213
	Oil Rubbed Bronze	9056214
	Satin Nickel	9056215

Frenchwood® Gliding Doors (1987 to Present)

2-Panel, 4-Panel, and Stationary

Hardware

Key Cylinder - Whitmore®

Note:

Whitmore® lock assembly uses a 6 pin replacement cylinder are found on [page 85](#).

Bolt Package - Whitmore® / Exterior Lock

Note:

Bolt package is included in the shared lock parts section [page 85](#).

Lock Housing - Whitmore® / Exterior

Note:

Replace with complete exterior lock assembly.

Finish	Order No.
Antique Brass	N/A
Bright Brass	
Oil Rubbed Bronze	
Satin Nickel	

Hardware

Hardware - Encino®

Note:
See [Accessory Guide 0005414](#).

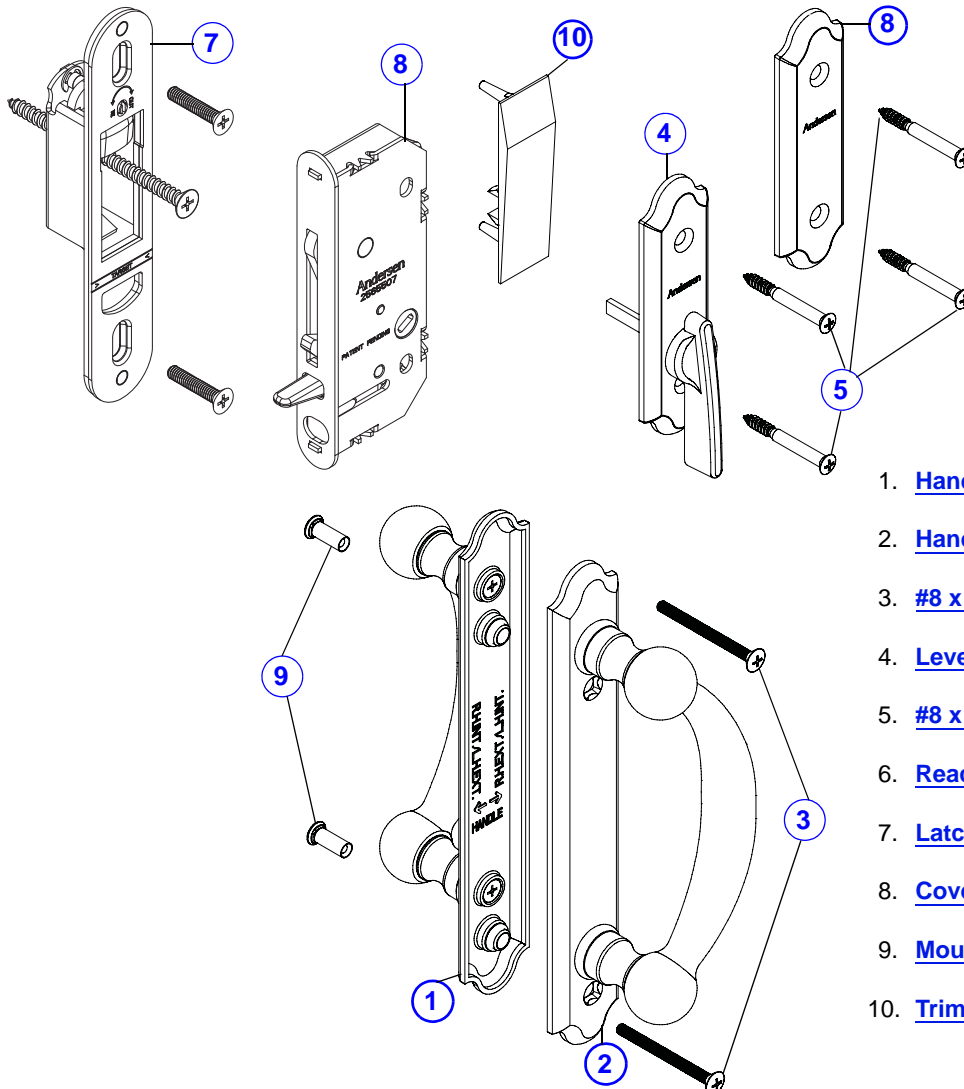

1. [Handle RH Interior/LH Exterior](#)
2. [Handle LH Interior/RH Exterior](#)
3. [#8 x 2" Oval Head Threaded Bolt](#)
4. [Lever Latch](#)
5. [#8 x 1 3/4" Oval Head Screw](#)
6. [Reachout Lock Assembly-2 panel](#)
7. [Latch Receiver-2 panel](#)
8. [Cover Plate \(4-Panel Doors\)](#)
9. [Mounting Stud](#)
10. [Trim Plate \(2-Panel Doors\)](#)

Encino® Gliding Patio Door Hardware - 2-Panel Trim Set

Trim Set Hardware - Encino® / Interior and Exterior / 2-Panel

Finish	Order No.
Distressed Bronze	2565553
Distressed Nickel	2565555

Trim Set Hardware - Encino® / Interior and Exterior / 4-Panel

Finish	Order No.
Distressed Bronze	2565554
Distressed Nickel	2565556

Frenchwood® Gliding Doors (1987 to Present)

2-Panel, 4-Panel, and Stationary

Hardware

Trim Set Hardware - Encino® / Interior / 2-Panel		
	Finish	Order No.
	Distressed Bronze	2562113
	Distressed Nickel	2562117
Trim Set Hardware - Encino® / Interior / 4-Panel		
	Finish	Order No.
	Distressed Bronze	2562104
	Distressed Nickel	2562108
Trim Set Hardware - Encino® / Exterior / 2-Panel		
	Finish	Order No.
	Distressed Bronze	2562058
	Distressed Nickel	2562062
Trim Set Hardware - Encino® / Exterior / 4-Panel		
	Finish	Order No.
	Distressed Bronze	2562059
	Distressed Nickel	2562063

Handle - Encino® Ref. No. 1 & 2 page 74			
Note: Handles are sold assembled with escutcheon plates	Finish	Left Interior/ Right Exterior	Right Interior/ Left Exterior
	Distressed Bronze	2573161	2573162
	Distressed Nickel	2573163	2573164

Cover Plate with Screws - Encino® / 4-Panel Ref. No. 8 page 74		
Note: Ships with fasteners.	Finish	Order No.
	Distressed Bronze	2573175
	Distressed Nickel	2573176

Thumb Latch/Latch Lever - Encino® / Inside Lock Ref. No. 4 page 74		
Note: Ships with fasteners. See Latch Lever Replacement Video .	Finish	Order No.
	Distressed Bronze	2573169
	Distressed Nickel	2573170

Screw Package - Trim Set / Encino®
Note: Screw package is included in the shared hardware section page 84 .

Hardware

Lock Assembly with Keys - Encino®

Note:

Lock assemblies will have two (2) cut keys and two (2) 2 1/4" bolts.

Order keyed alike exterior locks with the number of locks need.

See [Accessory Guide 0005196](#).

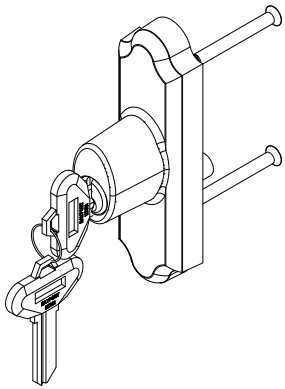
	Finish	Lock Assembly		Keyed Alike	
		Left	Right	Left	Right
		Distressed Bronze	2573189	2573086	9056182
Distressed Nickel	2573190	2573087	9056183	9056185	

Lock Assembly with Keys - Encino® / Exterior / Keyed Alike Right Hand and Left Hand

Note:

Contains 1 right hand and 1 left hand assembly

Finish	Order No.
Distressed Bronze	9056216
Distressed Nickel	9056217

Key Cylinder - Encino®

Note:

Encino® lock assembly uses a 6 pin replacement cylinder are found on [page 85](#).

Bolt Package - Encino® / Exterior Lock

Note:

Bolt package is included in the shared lock parts section [page 85](#).

Lock Housing - Encino® / Exterior

Note:

Replace with complete exterior lock assembly.

Finish	Order No.
Distressed Bronze	N/A
Distressed Nickel	N/A

Frenchwood® Gliding Doors (1987 to Present)

2-Panel, 4-Panel, and Stationary

Hardware

Hardware - Yuma®

Note:

See [Accessory Guide 0005414](#).

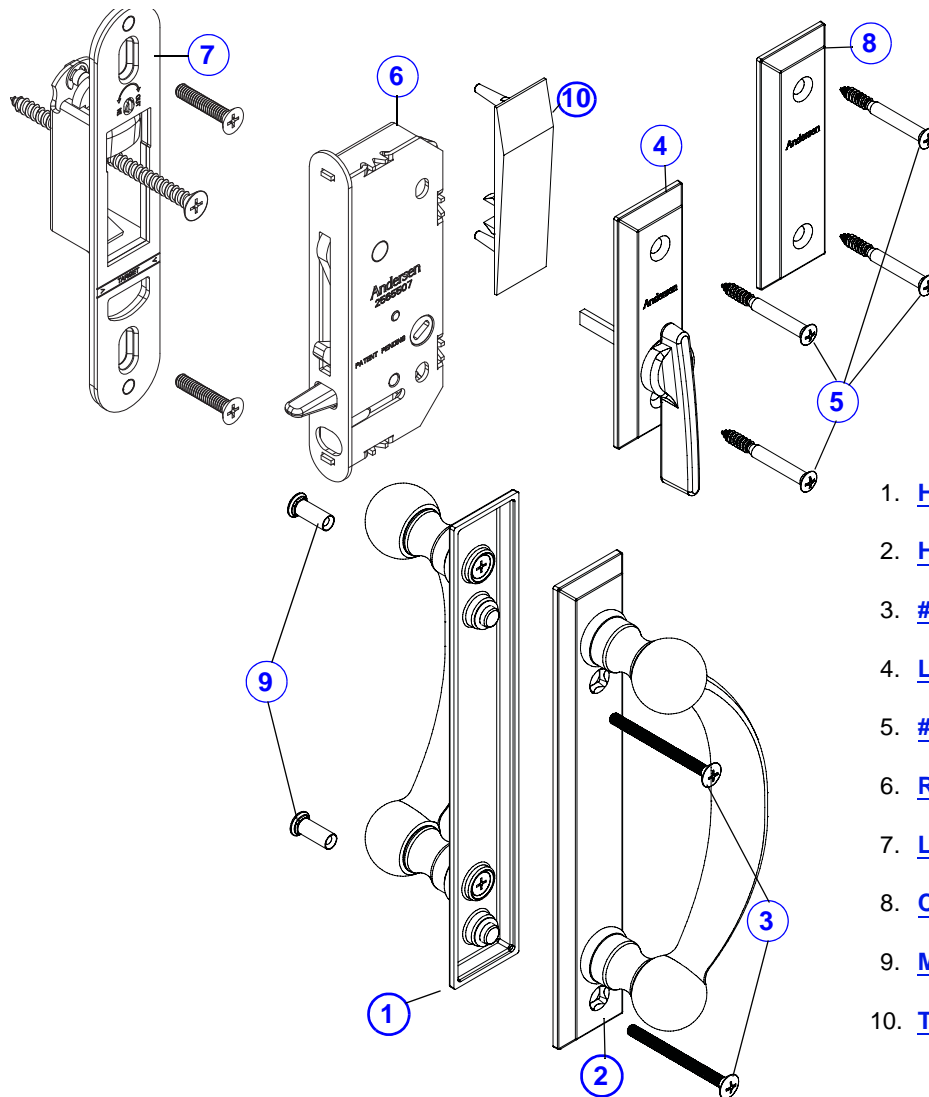

1. [HandleRH Interior/LH Exterior](#)
2. [Handle LH Interior/RH Exterior](#)
3. [#8 x 2" Oval Head Threaded Bolt](#)
4. [Latch Lever](#)
5. [#8 x 1 3/4" Screw](#)
6. [Reachout Lock Assembly-2 panel](#)
7. [Latch Receiver-2 panel](#)
8. [Cover Plate \(4-Panel Doors\)](#)
9. [Mounting Stud](#)
10. [Trim Plate \(2-Panel Doors\)](#)

Yuma® Gliding Patio Door Hardware - 2-Panel Trim Set

Trim Set Hardware - Yuma® / Interior and Exterior

	Panels	Finish	Order No.
	2	Distressed Bronze	2565557
		Distressed Nickel	2565559
	4	Distressed Bronze	2565558
		Distressed Nickel	2565560

Hardware

Trim Set Hardware - Yuma® / Interior			
	Panels	Finish	Order No.
	2	Distressed Bronze	2562115
		Distressed Nickel	2562119
	4	Distressed Bronze	2562106
		Distressed Nickel	2562110

Trim Set Hardware - Yuma® / Exterior			
	Panels	Finish	Order No.
	2	Distressed Bronze	2562060
		Distressed Nickel	2562064
	4	Distressed Bronze	2562061
		Distressed Nickel	2562065

Handle - Yuma® Ref. No. 1 & 2 page 77			
Note: Handles are sold assembled with escutcheon plates.	Finish	Left Interior/ Right Exterior	Right Interior/ Left Exterior
	Distressed Bronze	2573165	2573166
	Distressed Nickel	2573167	2573168

Thumb Latch/Latch Lever - Yuma® / Inside Lock Ref. No. 4 page 77		
Note: Ships with fasteners. See Latch Lever Replacement Video .	Finish	Order No.
	Distressed Bronze	2573171
	Distressed Nickel	2573172

Cover Plate with Screws - Yuma® / 4-Panel Ref. No. 8 page 77		
Note: Ships with fasteners	Finish	Order No.
	Distressed Bronze	2573177
	Distressed Nickel	2573178

Screw Package - Trim Set / Yuma®
Note: Screw package is included in the shared hardware section page 84 .

Frenchwood® Gliding Doors (1987 to Present)

2-Panel, 4-Panel, and Stationary

Hardware

Lock Assembly with Keys - Yuma®

Note:

Lock assemblies will have two (2) cut keys and two (2) 2 1/4" bolts.

Order keyed alike exterior locks with the number of locks need.

See [Accessory Guide 0005196](#).

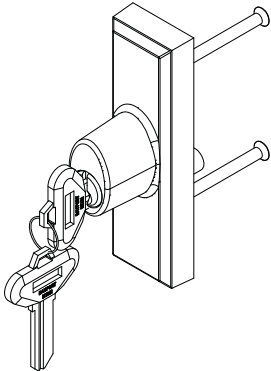
			Lock Assembly		Keyed Alike	
		Finish	Left	Right	Left	Right
		Distressed Bronze	2573193	2573088	9056188	9056186
		Distressed Nickel	2573194	2573089	9056189	9056187

Lock Assembly with Keys - Yuma® / Exterior/ Keyed Alike Right-Hand and Left-Hand

Note:

Contains 1 right hand and 1 left hand assembly

Finish	Order No.
Distressed Bronze	9056218
Distressed Nickel	9056219

Key Cylinder - Yuma®

Note:

Yuma® lock assembly uses a 6 pin replacement cylinder are found on [page 85](#).

Bolt Package - Yuma® / Exterior Lock

Note:

Bolt package is included in the shared lock parts section [page 85](#).

Lock Housing - Yuma® / Exterior

Note:

Replace with complete exterior lock assembly.

Finish	Order No.
Distressed Bronze	N/A
Distressed Nickel	N/A

Hardware

Hardware - Albany

Note:

See [Accessory Guide 0005414](#).

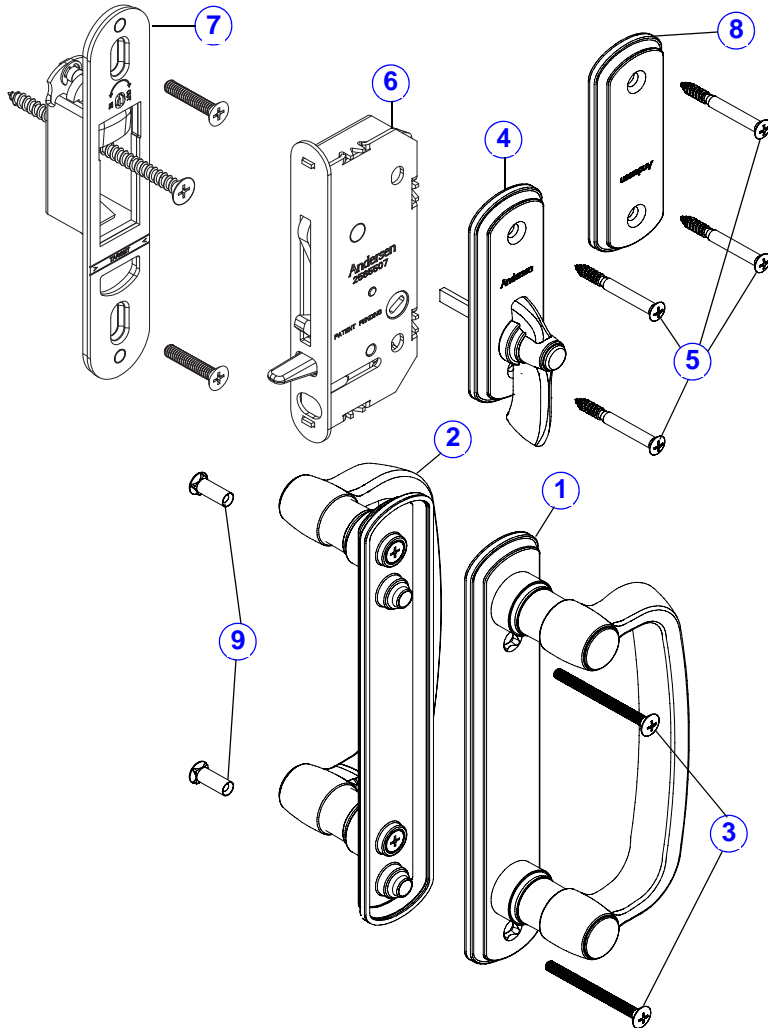

1. [Handle RH Interior/LH Exterior](#)
2. [Handle LH Interior/RH Exterior](#)
3. [#8 x 2" Oval Head Threaded Bolt](#)
4. [Latch Lever](#)
5. [#8 x 1 3/4" Screw](#)
6. [Reachout Lock Assembly-2 panel](#)
7. [Latch Receiver-2 panel](#)
8. [Cover Plate](#)
9. [Mounting Stud](#)

Albany Gliding Patio Door Hardware - 2-Panel Trim Set

Frenchwood® Gliding Doors (1987 to Present)

2-Panel, 4-Panel, and Stationary

Hardware

Trim Set Hardware - Albany / Interior and Exterior			
	Panels	Finish	Order No.
	2	White	9007538
		Stone	9007539
		Gold Dust	9007540
		Black	9007541
	4	White	9007542
		Stone	9007543
		Gold Dust	9007544
		Black	9007545

Trim Set Hardware - Albany / Interior			
	Panels	Finish	Order No.
	2	White	9007554
		Stone	9007556
		Gold Dust	9007558
		Black	9007560
	4	White	9007555
		Stone	9007557
		Gold Dust	9007559
		Black	9007561

Trim Set Hardware - Albany / Exterior			
	Panels	Finish	Order No.
	2	White	9007562
		Stone	9007564
		Gold Dust	9007566
		Black	9007568
	4	White	9007563
		Stone	9007565
		Gold Dust	9007567
		Black	9007569

Handle - Albany Ref. No. 1 & 2 page 80			
Note: Handles are sold assembled with escutcheon plates.	Finish	Left Interior/ Right Exterior	Right Interior/ Left Exterior
	White	9018914	9018915
	Stone	9018916	9018917
	Gold Dust	9018918	9018919
	Black	9018920	9018921

Hardware

Thumb Latch/Latch Lever - Albany / Inside Lock Ref. No. 4 page 80		
Note: Ships with fasteners. See Latch Lever Replacement Video .	Finish	Order No.
	White	9018922
	Stone	9018923
	Gold Dust	9018924
	Black	9018925

Plate Cover - Albany Ref. No. 8 page 80		
Note: Use one cover plate on two panel units; three cover plates on four panel units.s	Finish	Order No.
	White	9018926
	Stone	9018927
	Gold Dust	9019178
	Black	9018928

Screw Package - Trim Set / Albany		
Note: Screw package is included in the shared hardware section page 84 .		

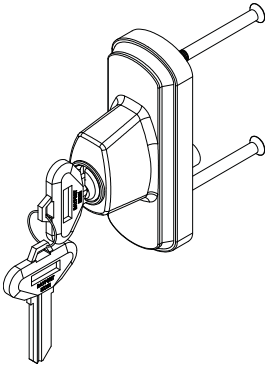
Lock Assembly with Keys - Albany/ Exterior					
Note: Lock assemblies will have two (2) cut keys and two (2) 2 1/4" bolts. Order keyed alike exterior locks with the number of locks need. See Accessory Guide 0005196 .					
	Left	Right	Left	Right	
	White	9018898	9018902	9056190	9056194
	Stone	9018899	9018903	9056191	9056195
	Gold Dust	9018900	9018904	9056192	9056196
	Black	9018901	9018905	9056193	9056197

Lock Assembly with Keys - Albany / Exterior/ Keyed Alike Right-Hand and Left-Hand		
Note: Contains 1 right hand and 1 left hand assembly	Finish	Order No.
	White	9056220
	Stone	9056221
	Gold Dust	9056222
	Black	9056223

Frenchwood® Gliding Doors (1987 to Present)

2-Panel, 4-Panel, and Stationary

Hardware

Key Cylinder - Albany

Note:

Albany lock assembly uses a 6 pin replacement cylinder are found on [page 85](#).

Bolt Package - Yuma® / Exterior Lock

Note:

Bolt package is included in the shared lock parts section [page 85](#).

Lock Housing - Albany / Exterior

Note:

Replace with complete exterior lock assembly.

Finish	Order No.
White	N/A
Stone	
Gold Dust	
Black	

Hardware

Shared Trim Set Parts / Current

Screw Package - Trim Set / Other Hardware Styles

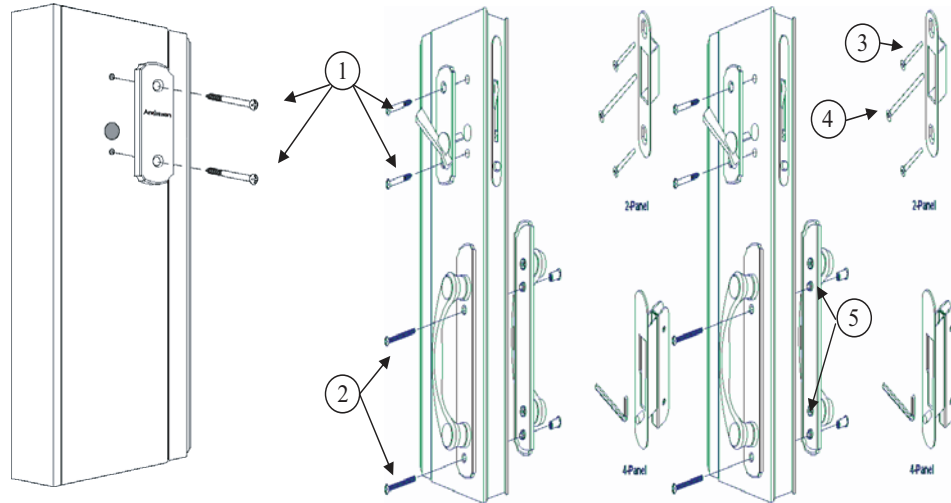

Ref. No.	Package includes:
1	8 - screws, #10 -16 x 1 3/4" PH #8 oval head type AB
2	4 - screws, #8 - 32 UNC x 2 PH #10 oval head mach
3	2 - screws, #8 - 32 UNC x 7/8" PH FL mach
4	1 - screw, #10 - 13 x 3" PH FL wood
5	4 - studs

Finish	Order No.
Stone (Albany)	9056232
White (Albany)	9056233
Antique Brass	2579762
Bright Brass	2579761
Polished Chrome	2579763
Brushed Chrome	
Satin Nickel	2579391
Distressed Nickel	2573180
Oil Rubbed Bronze	2579765
Distressed Bronze	
Gold Dust (Albany)	9019313
Black (Albany)	9019314

Trim Plate Assembly - 2 and 4 Panel



Note:
Distressed Bronze uses Oil Rubbed Bronze.

If replacement finish is marked as N/A, replace with 4 panel cover plate matching the hardware style of the trim set: Covington™, Newbury®, Encino®, or Yuma®

Finish	Order No.
Polished Chrome	N/A
Antique Brass	2573694
Bright Brass	N/A
Oil Rubbed Bronze	2573693
Brushed Chrome	N/A
Satin Nickel	N/A
Distressed Bronze	2573693
Distressed Nickel	2573174

Frenchwood® Gliding Doors (1987 to Present)

2-Panel, 4-Panel, and Stationary

Hardware

Lock Parts / Current

Lock Cylinder with Keys - 6-Pin (January 2004 to Present)

 <p>Brushed Brass</p> <p>Brushed Chrome</p> <p>Oil Rubbed Bronze</p>	<p>Note: Remove C ring and cylinder tab prior to installation. Newbury® lock assembly has used a 6 pin cylinder since January of 2004. Glass dates from panel do not always represent the vintage of the lock assembly or the replacement key cylinder needed. Finish on exterior facing surface and may not match color of lock housing. Housing finish shown for identification purposes. The key used on a 6 pin cylinder will have 6 valleys/ grooves.</p> <p>5 pin key cylinder 1994-2004 page 89</p> <p>See Service Guide 0005130</p>	Housing Finish	Cylinder Finish	Order No.
		White	Brushed Chrome	By description
		Stone	Brushed Chrome	By description
		Antique Brass	Brushed Brass	By description
		Bright Brass	Brushed Brass	By description
		Polished Chrome	Brushed Chrome	By description
		Brushed Chrome	Brushed Chrome	By description
		Satin Nickel	Brushed Chrome	By description
		Oil Rubbed Bronze	Oil Rubbed Bronze	By description
		Distressed Bronze	Oil Rubbed Bronze	By description
		Distressed Nickel	Brushed Chrome	By description
		Gold Dust	Brushed Chrome	By description
		Black	Oil Rubbed Bronze	By description

Blank Key - Reachout Lock

	Order No.
	2573561

Bolt for Keyed Lock - Other Hardware Styles / Lock Housing / Exterior

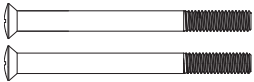
	Description	Finish	Order No.
	Qty 2 - 2 1/4" x #10	Polished Chrome	2573641
	<p>Note: Use for all trim sets except Tribeca®.</p> <p>Distressed Bronze uses Oil Rubbed Bronze.</p>	Antique Brass	2573550
		Bright Brass	2573541
		Oil Rubbed Bronze	2579947
		Brushed Chrome	2579948
		Satin Nickel	2579423
		Distressed Bronze	2579947
		Distressed Nickel	2573158

Hardware

Lock and Receiver Kit - Reachout / 2-Panel (2006 to Present)

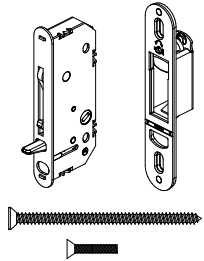
	<p>Note: Use this kit to replace previous vintage reachout locks (1986 to 2005). Refer to Accessory Guide 0005414 when using as trim set and hardware application and Service Guide 0000127 when using as reachout lock replacement.</p> <p>Kit includes: Reachout lock assembly Latch receiver 2-panel door #10 x 3 flat head security screw #8 x 7/8 machine screws</p>	Order No.
		2562123

Lock and Receiver Kit - Reachout / 4-Panel (2006 to Present)

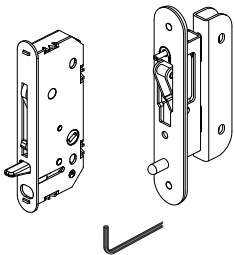
	<p>Note: Use this kit to replace previous vintage reachout locks (1986 to 2005). Refer to Accessory Guide 0005414 when using as trim set and hardware application and Service Guide 0000127 when using as reachout lock replacement.</p> <p>Kit includes: 4-panel receiver, lock assembly, 9/64" hex wrench.</p>	Order No.
		2562124

Screw - Security / Reachout Strike / 2-Panel (1994 to Present)

	Description	Order No.
	#10 x 3	2573574

Screw - Security / Reachout Lock / 2-Panel (1994 to Present)

	Description	Order No.
	#8 x 7/8" machine	By description

Auxiliary Security Lock with Screws

<p>Note: See Auxiliary Lock Installation Video.</p>		
	Finish	Order No.
	Stone	1997220
	White	1997301
	Polished Chrome	2565707
	Antique Brass	2565718
	Bright Brass	2565710
	Oil Rubbed Bronze	2579955
	Brushed Chrome	2579956
	Satin Nickel	2579426
	Distressed Bronze	2573187
	Distressed Nickel	2573188
	Black	9007625
Gold Dust	9007624	

Frenchwood® Gliding Doors (1987 to Present)

2-Panel, 4-Panel, and Stationary

Hardware

Grommet - Auxiliary Security Lock	
	Order No.
	9056272

Hardware

Lock Parts / Vintage

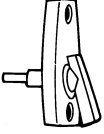
Thumb Latch Lock - Inside / Old Style (1987 to 1993)			
	Note: Replace with current vintage Tribeca® inside lock thumb latch assembly, page 58 . Will also need to replace all current locking hardware.	Finish	Order No.
		Stone	N/A
		White	N/A

Thumb Latch Lock - Inside / Old Style (1987 to 1993)		
	Note: Replace with current vintage Newbury® inside lock thumb latch assembly, page 65 . Will also need to replace with all current locking hardware.	Bright Brass N/A

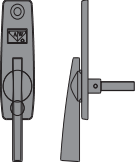
Thumb Latch - Inside / Reachout (1994 to 1999)			
	Note: Replace with current vintage Tribeca® inside lock thumb latch assembly, page 58 .	Finish	Order No.
		Stone	N/A
		White	

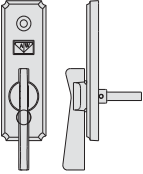
Thumb Latch Lock - Inside / Reachout (1994 to 1999)			
	Note: Replace with current vintage inside Newbury® thumb latch assembly, page 65	Finish	Order No.
		Chrome	N/A
		Antique Brass	
		Bright Brass	

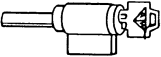
Lock Cylinder with Keys / 2-Panel (1987 to 1993)		
		Bright Brass 2573526

Frenchwood® Gliding Doors (1987 to Present)

2-Panel, 4-Panel, and Stationary

Hardware

Exterior Lock with Keys / Old Style (1987 to 1993)

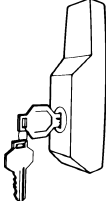
	Note: Replacement key cylinders are not available. If replacing exterior lock replace with current style exterior lock and all current locking hardware.	Finish	Order No.
		Stone	N/A

Exterior Lock with Keys - 6 Pin / 2-Panel / Reachout (1994 to 1999)

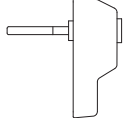
	Note: Replacement key cylinders are not available.	Finish	Order No.
		Stone	1973046

Exterior Lock with Keys - 5 Pin / Old Style (1987 to 1993)

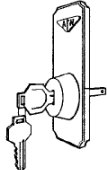
	Note: Key cylinder can be replaced with 2565717 as shown below. If replacing exterior lock replace with current style exterior lock and all current locking hardware.	Finish	Order No.
		Bright Brass	N/A

Lock Cylinder with Keys - 5-Pin / Reachout Estate (1994 to January 2004)

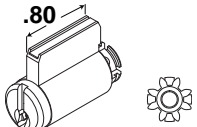
	Note: Includes gears and key, no tail. The key used on a 5 pin cylinder will have 5 valleys/groves. 6 pin key cylinder 2004-Present page 85	Finish	Order No.
		Silver Satin	2565715
		Bright Brass	2565717

Deadlock - Universal / Old Style / 2-Panel (1987 to 1993)

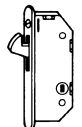
		Order No.
		1997156

Lock Assembly - Reachout (1994 to 2005)

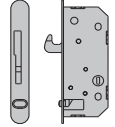
	Note: Individual parts are not available. Order reachout lock replacement kit for replacement parts page 86	Order No.
		N/A

Hardware

Strike with Liner - Old Style (1987 to 1993)

 <p>Liner</p> <p>2 Pan. 4" 4 Pan. 5½"</p>		Order No.	
		Strike with liner 2 panel	1997155
		Strike 4 panel	N/A
		Liner 4 panel	2565503

Lock Receiver - Reachout / 2-Panel (1994 to 2005)

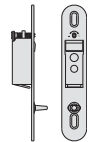
	Note: Individual parts are not available. Order reachout lock replacement kit for replacement parts page 86	Order No.
		N/A

Lock Strike Plate - Reachout / 4-Panel (1994 to 2005)

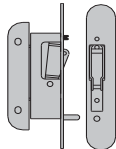
	Note: Individual parts are not available. Order reachout lock replacement kit for replacement parts page 86	Order No.
		N/A

Screw - Reachout Receiver / Security / 2-Panel

	Description	Order No.
	3 x 10	2573574

Screw - Reachout Receiver / Machine / 2-Panel

	Description	Order No.
	#8-32	3620474

Hardware Conversion Kit - Reachout Lock / 2- and 4-Panel 1994 to 1999

	Note: Replace with reachout lock/receiver kit (2006 to Present), page 86 .	Order No.
		N/A

Frenchwood® Gliding Doors (1987 to Present)

2-Panel, 4-Panel, and Stationary

Hardware

Vintage Trim Set Parts

Handle - Inside / 2- and 3-Panel (1982)			
	Note: These can be used on 2-panel and 4-panel Frenchwood® Gliding units. Handles do not ship with screws.	Finish	Order No.
		Stone	1997201
		White	8292401

Handle - Outside / 2-Panel (1982)			
	Note: These can be used on 2-panel and 4-panel Frenchwood® Gliding units. Handles do not ship with screws.	Finish	Order No.
		Stone	1997202
		White	8292402

Bolt - Handle Package			
	Description	Finish	Order No.
	2 3/32" x #10-32 O.H. steel	Stone	1275210
	Note: Order No. 1275210 replaces 2573646	White	1997295

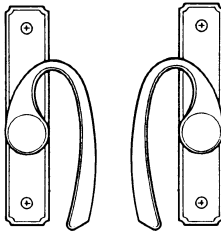
Handle - French Curve (1994 to 1999)				
	Note: French curve handles project over the glass. Replace with current style handle or patio door hardware set.	Finish	Left-Hand Interior/Right-Hand Exterior	Right-Hand Interior/Left-Hand Exterior
		Antique Brass	N/A	N/A
		HP Brass	N/A	N/A

Cover Plate - 4 Panel (1987 to 1999)			
		Finish	Order No.
		Stone	2573508
		White	N/A

Hardware

Screw Packages - Frame

Note:

Select Forest Green screw packs use Terratone® screw packs.

Screw Package - Frame / FWG/NLGD 50/60 / 68/611

Package includes:			Color	Order No.
Qty.	Description	Where Used		
2	Panel handle hole plugs - gray	Operating panel side stile	White	2573654
14	2-1/2" x #10 (clear crm)	Frame, sill side jamb/head jamb	Terratone®	2653826
9	2-1/2" x #10	Frame to opening (color head)	Sandtone	0912804
1	Insect screen latch	Frame lock jamb	Forest Green	1260157
1	1" x #8 - colored	Screen latch	Canvas	9046450
4	1" x #8 - gray	Panel to sill filler flange	Prefinished White	2573671
5	1" x #8 - colored	Head bracket screws (painted head)		
7	1-1/2" x #8 - brass	Head inside stop /sill support to wall		
18	5/8" x #7 - pan head	Interlock weatherstrip		
1	Stationary panel bracket	Head jamb and stationary panel		

Screw Package - Frame / FWG/NLGD 8068 / 611

Package includes:			Color	Order No.
Qty.	Description	Where Used		
2	Panel handle hole plugs - gray	Operating panel side stile	White	2573650
14	2-1/2" x #10 (clear crm)	Frame, sill side jamb/head jamb	Terratone®	2653835
11	2-1/2" x #10	Frame to opening (color head)	Sandtone	0912813
6	1" x #8 - colored	Head bracket screws (painted head)	Forest Green	1260158
5	1" x #8 - gray	Panel to sill filler flange	Canvas	9046456
1	1" x #8 - colored	Screen latch	Prefinished White	2573673
10	1-1/2" x #8 - brass	Head inside stop /sill support to wall		
18	5/8" x #7 - pan head	Interlock weatherstrip		
1	Stationary panel bracket	Head jamb and stationary panel		
1	Insect screen latch	Frame lock jamb		

Screw Package - Frame / FWG/NLGD 50/60 / 8080

Package includes:			Color	Order No.
Qty.	Description	Where Used		
2	Panel handle hole plugs - gray	Operating panel side stile	White	2573655
14	2-1/2" x #10 (clear crm)	Frame, sill side jamb/head jamb	Terratone®	2653827
13	2-1/2" x #10	Frame to opening (color head)	Sandtone	0912805
6	1" x #8 - colored	Head bracket screws (painted head)	Forest Green	1260159
5	1" x #8 - gray	Panel to sill filler flange	Canvas	9046451
1	1" x #8 - colored	Screen latch	Prefinished White	2573672
10	1-1/2" x #8 - brass	Head inside stop /sill support to wall		
22	5/8" x #7 - pan head	Interlock weatherstrip		
1	Stationary panel bracket	Head jamb and stationary panel		
1	Insect screen latch	Frame lock jamb		

Frenchwood® Gliding Doors (1987 to Present)

2-Panel, 4-Panel, and Stationary

Hardware

Screw Package - Frame / FWG/NLGD 100/120 / 68/611

Package includes:				Color	Order No.
Qty.	Description	Where Used			
	Panel handle hole plugs - gray	Operating panel side stile		White	2573656
4				Terratone®	2653828
14	2-1/2" x #10 (clear crm)	Frame, sill side jamb/head jamb		Sandtone	0912806
13	2-1/2" x #10	Frame to opening (color head)		Forest Green	2653828
1	5/8" x #7 filister head	4-panel screw lock stopper screw		Canvas	0912806
8	1" x #8 - gray	Panel to sill filler flange		Prefinished White	2573674
10	1" x #8 - colored	Head bracket screws (painted head)			
20	1-1/2" x #8 - brass	Head inside stop /sill support to wall			
36	5/8" x #7 - pan head	Interlock weatherstrip			
2	Stationary panel bracket	Head jamb and stationary panel			

Screw Package - Frame / FWG/NLGD 16068 / 611

Package includes:				Color	Order No.
Qty.	Description	Where Used			
	Panel handle hole plugs - gray	Operating panel side stile		White	2573657
4				Terratone®	2653829
14	2-1/2" x #10 (clear crm)	Frame, sill side jamb/head jamb		Sandtone	0912807
17	2-1/2" x #10	Frame to opening (color head)		Forest Green	2653829
1	5/8" x #7 filister head	4-panel screw lock stopper screw		Canvas	0912807
8	1" x #8 - gray	Panel to sill filler flange		Prefinished White	2573676
10	1" x #8 - colored	Head bracket screws (painted head)			
20	1-1/2" x #8 - brass	Head inside stop /sill support to wall			
36	5/8" x #7 - pan head	Interlock weatherstrip			
2	Stationary panel bracket	Head jamb and stationary panel			



Screw Package - Frame / FWG/NLGD 100 / 12080

Package includes:				Color	Order No.
Qty.	Description	Where Used			
	Panel handle hole plugs - gray	Operating panel side stile		White	2573663
4				Terratone®	2653831
14	2-1/2" x #10 (clear crm)	Frame, sill side jamb/head jamb		Sandtone	0912801
15	2-1/2" x #10	Frame to opening (color head)		Forest Green	2653831
1	5/8" x #7 filister head	4-panel screw lock stopper screw		Canvas	0912801
8	1" x #8 - gray	Panel to sill filler flange		Prefinished White	2573675
10	1" x #8 - colored	Head bracket screws (painted head)			
20	1-1/2" x #8 - brass	Head inside stop /sill support to wall			
36	5/8" x #7 - pan head	Interlock weatherstrip			
2	Stationary panel bracket	Head jamb and stationary panel			

Hardware

Screw Package - Frame / FWG/NLGD 16080				
Package includes:			Color	Order No.
Qty.	Description	Where Used		
4	Panel handle hole plugs - gray	Operating panel side stile	White	2573664
14	2-1/2" x #10 (clear crm)	Frame, sill side jamb/head jamb	Terratone®	2653832
19	2-1/2" x #10	Frame to opening (color head)	Sandtone	0912803
1	5/8" x #7 filister head	4-panel screw lock stopper screw	Forest Green	2653832
8	1" x #8 - gray	Panel to sill filler flange	Canvas	0912803
10	1" x #8 - colored	Head bracket screws (painted head)	Prefinished White	2573677
20	1-1/2" x #8 - brass	Head inside stop /sill support to wall		
36	5/8" x #7 - pan head	Interlock weatherstrip		
2	Stationary panel bracket	Head jamb and stationary panel		

Screw Package - Sidelight / Frame / FWG/NLGD 29/33/43				
Package includes:			Color	Order No.
Qty.	Description	Where Used		
14	2-1/2" x #10 (clear crm)	Frame, sill side jamb/head jamb	White	2573653
10	2-1/2" x #10 (colored heads)	Frame to opening (color head)	Terratone®	2653825
4	1" x #8 gray	Panel to sill filler flange	Sandtone	0912802
12	3/4" x #8	Exterior side stops	Forest Green	1262831
			Canvas	9046449
			Prefinished White	2573653

Fasteners			
Screw - Frame			
	Description	Steel	
	2 1/2" x #10 F.H. steel	1973113	
Screw - Security Lock			
	Description	Finish	Order No.
	2" x #8 Dome head brass	Brass	2573644
		Antique Brass	2573552
		Chrome	2573643

Screw - Sill Support		
	Description	Bronze
	1 1/2" x #8 F.H. steel	3622195

Screw - Inside Head Stop		
	Description	Bronze
	1 1/2" x #8 F.H. steel	3622195

Frenchwood® Gliding Doors (1987 to Present)

2-Panel, 4-Panel, and Stationary

Hardware

Screw - Sill Filler			
	Description	Finish	Order No.
	1" x 8" F.H. steel	Gray	3620210

Screw - Head Bracket / Stationary Panel			
	Description	Finish	Order No.
	1" x 8" F.H. steel	Gray	1973112
		White	2500702
		Stone	2653862

Screw - Interlock Weatherstrip			
	Description	Color	Order No.
	5/8" x #7 Pan steel	White	3621090
		Terratone®	3621100

Screw - Insect Screen Stop / 4-Panel			
	Description		Order No.
	5/8" x #7 F.H. steel		1973107

Screw - I.D. Plate			
	Description	Finish	Order No.
	5/8" x #6 F.H. steel	Stone	9056235
		White	9056234

Screw - Insect Screen Pull / 2-Panel			
	Description		Order No.
	1" x #6 F.H. steel	Stone	By description

Screw - Insect Screen Stopper / 4-Panel			
	Description	Finish	Order No.
	5/8" x #8 Fillister stainless steel	Stone	8292922
		White	8292923

Screw - Lock Strike			
	Description		Order No.
	1 3/16" x #8-32 Mach F.H. steel	Silver	8323406

Screw			
	Description		Order No.
	10-12 x 1 PH PAN HD TA 18-8 SST		2579405

Hardware

Screw			
	Description	Color	Order No.
	10-12 x 2 PH OVAL TA 18-8	White	2579403
		Beige	2579404
		Terratone®	2653869
		Sandtone	0912719
		Forest Green	1269111

Screw			
	Description	Color	Order No.
	8-15 x 1 TYP 17PH FH HEAD T/C Z-Y	White	2500702
		Terratone®	2653862
		Gray	2500704

Screw			
	Description	Color	Order No.
	8-18 x 3/4 TYP 17 PH FH HEAD T/C	White	2500706
		Terratone®	2653864
		Sandtone	0904112
		Forest Green	1269110

Screw - Reachout Strike Conversion		
	Description	Order No.
	5/8 x 8 FH	2573575

Screw		
	Description	Forest Green
	10-12 x 1 1/2 TYP 17 PH FH STL Z-Y	1269109

Screw		
	Description	Order No.
	8-15 x 1 1/2 TYP 17 PH FH Z-Y	2500701

Screw - Cover Plate		
	Description	White
	10 x 1 13/16	N/A

Screw		
	Description	Gray
	10 x 2-1/2 TYP AB PH PAN 410SS	0912718

Frenchwood® Gliding Doors (1987 to Present)

2-Panel, 4-Panel, and Stationary

Frames

Frame Assembly

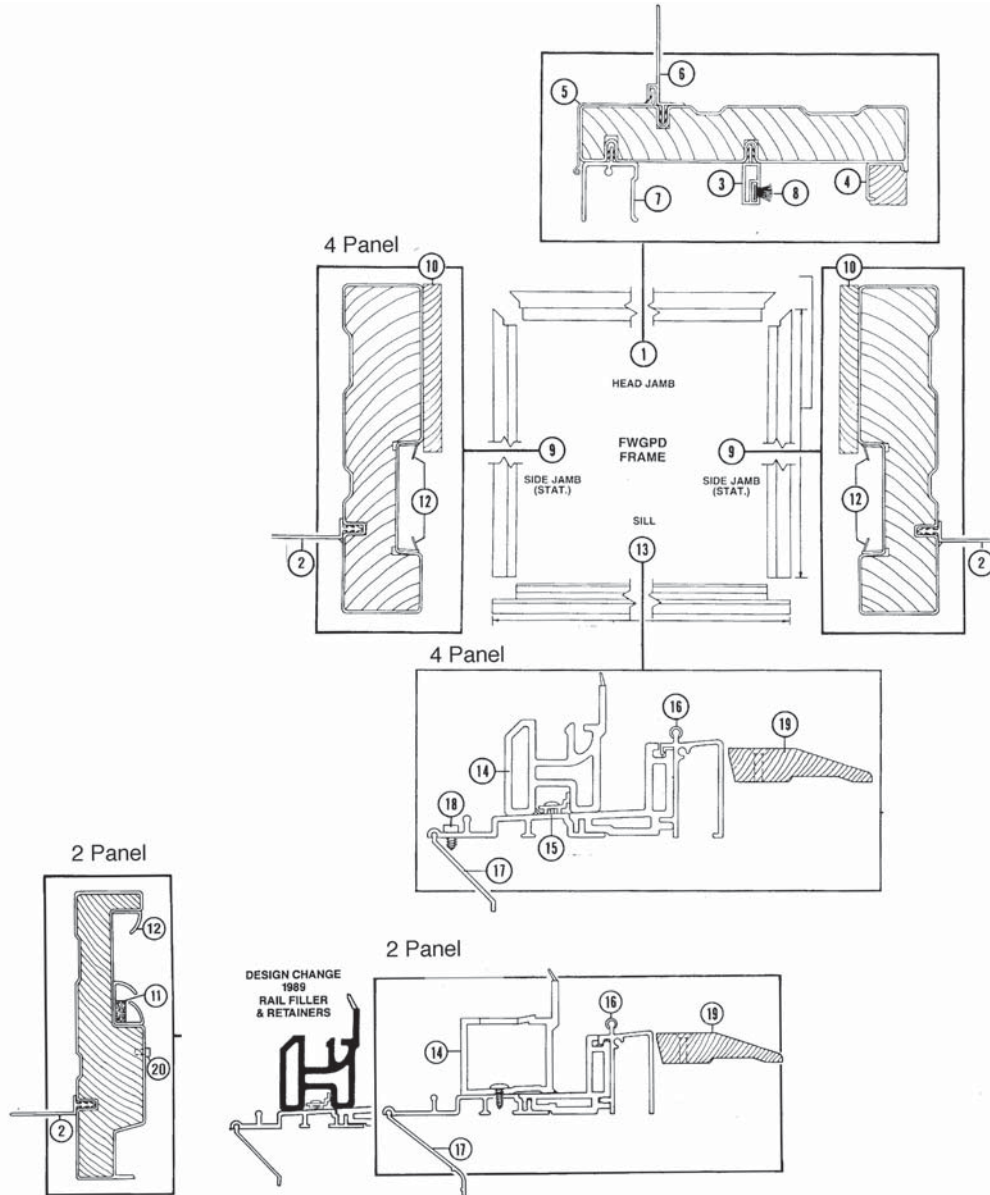

(Part listing is for 4-panel units)

- | | | |
|--|---|---|
| 1. Head Jamb Complete | 8. Head Parting Stop Pile W/S | 15. Center and End Rail Filler Retainers |
| 2. Side Windbreak Flange (Pr.) | 9. Inside Operating Side Jamb | 16. Cap, Sill Track |
| 3. Head Parting Stop | 10. Stationary Jamb Trim Piece | 17. Sill Support |
| 4. I.S. Head Stop | 11. Operator Side Jamb Plug | 18. Insect Screen Stopper Screw |
| 5. Head Flashing | 12. Stationary Jamb Weatherstrip | 19. Oak Threshold (Optional) |
| 6. Head Installation Flange | 13. Sill | 20. Insect Screen Lock Hole Plug - Fillister Head Screw |
| 7. Insect Screen Guide | 14. Stationary Bottom Rail Filler | |

Frenchwood® Gliding Frame Assembly - 2- and 4-Panel

Frames

Jambs

Note:

Frame parts (head jambs, side jambs) for custom sized doors are made to order. Product ID label is located on top edge of operating panel. Maple and Oak finishes introduced in 2000.

To order, state:

1. Description of part (Head Jamb, Side Jamb)
2. Handing (RH or LH)
3. Quantity
4. Product ID

Jamb - Head / Sidelight / Pine Interior

Unit No.	Length	Pine Interior/ White Exterior	Pine Interior/ Terratone Exterior	Pine Interior/ Sandtone Exterior	Pine Interior/ Forest Green Exterior
FWG29	32	By description	By description	By description	By description
FWG33	38	By description	By description	By description	By description
FWG43	50	By description	By description	By description	By description

Jamb - Head / Sidelight / Maple Interior

Unit No.	Length	Maple Interior/ White Exterior	Maple Interior/ Terratone Exterior	Maple Interior/ Sandtone Exterior	Maple Interior/ Forest Green Exterior
FWG29	32	By description	By description	By description	By description
FWG33	38	By description	By description	By description	By description
FWG43	50	By description	By description	By description	By description

Jamb - Head / Sidelight / Oak Interior

Unit No.	Length	Oak Interior/ White Exterior	Oak Interior/ Terratone Exterior	Oak Interior/ Sandtone Exterior	Oak Interior/ Forest Green Exterior
FWG29	32	By description	By description	By description	By description
FWG33	38	By description	By description	By description	By description
FWG43	50	By description	By description	By description	By description

Jamb - Head / Sidelight / Prefinished Interior White

	Unit No.	Length	Prefinished White Interior/ White Exterior
	FWG29	32	By description
	FWG33	38	By description
	FWG43	50	By description

Frenchwood® Gliding Doors (1987 to Present)

2-Panel, 4-Panel, and Stationary

Frames

Jamb - Head / 2-Panel / Pine Interior Ref. No. 1 page 97									
Unit No.	Length	Pine Interior/ White Exterior		Pine Interior/ Terratone Exterior		Pine Interior/ Sandtone Exterior		Pine Interior/ Forest Green Exterior	
		Left	Right	Left	Right	Left	Right	Left	Right
FWG50	59 1/4	By description		By description		By description		By description	
FWG60	71 1/4	By description		By description		By description		By description	
FWG80	95 1/4	By description		By description		By description		By description	
Jamb - Head / 2-Panel / Maple Interior Ref. No. 1 page 97									
Unit No.	Length	Maple Interior/ White Exterior		Maple Interior/ Terratone Exterior		Maple Interior/ Sandtone Exterior		Maple Interior/ Forest Green Exterior	
		Left	Right	Left	Right	Left	Right	Left	Right
FWG50	59 1/4	By description		By description		By description		By description	
FWG60	71 1/4	By description		By description		By description		By description	
FWG80	95 1/4	By description		By description		By description		By description	
Jamb - Head / 2-Panel / Oak Interior Ref. No. 1 page 97									
Unit No.	Length	Oak Interior/ White Exterior		Oak Interior/ Terratone Exterior		Oak Interior/ Sandtone Exterior		Oak Interior/ Forest Green Exterior	
		Left	Right	Left	Right	Left	Right	Left	Right
FWG50	59 1/4	By description		By description		By description		By description	
FWG60	71 1/4	By description		By description		By description		By description	
FWG80	95 1/4	By description		By description		By description		By description	
Jamb - Head / 2-Panel / Prefinished Interior White Ref. No. 1 page 97									
						Unit No.	Length	Prefinished White Interior/ White Exterior	
						Left	Right		
						FWG50	59 1/4	By description	
						FWG60	71 1/4	By description	
						FWG80	95 1/4	By description	

Frames

Jamb - Head / 4-Panel / Pine Interior Ref. No. 1 page 97

Note:

Support bracket is shipped with 16080 head jamb.

Unit No.	Length	Pine Interior/ White Exterior	Pine Interior/ Terratone Exterior	Pine Interior/ Sandtone Exterior	Pine Interior/ Forest Green Exterior
FWG100	117	By description	By description	By description	By description
FWG120	141	By description	By description	By description	By description
FWG16068/160611	189	By description	By description	By description	By description
FWG16080	189	By description	By description	By description	By description

Jamb - Head / 4-Panel / Maple Interior Ref. No. 1 page 97

Note:

Support bracket is shipped with 16080 head jamb.

Unit No.	Length	Maple Interior/ White Exterior	Maple Interior/ Terratone Exterior	Maple Interior/ Sandtone Exterior	Maple Interior/ Forest Green Exterior
FWG100	117	By description	By description	By description	By description
FWG120	141	By description	By description	By description	By description
FWG16068	189	By description	By description	By description	By description
FWG16068/160611	189	By description	By description	By description	By description

Jamb - Head / 4-Panel / Oak Interior Ref. No. 1 page 97

Note:

Support bracket is shipped with 16080 head jamb.

Unit No.	Length	Oak Interior/ White Exterior	Oak Interior/ Terratone Exterior	Oak Interior/ Sandtone Exterior	Oak Interior/ Forest Green Exterior
FWG100	117	By description	By description	By description	By description
FWG120	141	By description	By description	By description	By description
FWG16068/160611	189	By description	By description	By description	By description
FWG16080	189	By description	By description	By description	By description

Jamb - Head / 4-Panel / Prefinished Interior White Ref. No. 1 page 97

Note:

Support bracket is shipped with 16080 head jamb.

	Unit No.	Length	Prefinished Interior White/ White Exterior
	FWG100	117	By description
	FWG120	141	By description
	FWG16068/160611	189	By description
	FWG16080	189	By description

Frenchwood® Gliding Doors (1987 to Present)

2-Panel, 4-Panel, and Stationary

Frames

Jamb - Operating / Side Ref. No. 9 page 97									
Note: Jambs are handed as viewed from exterior.									
Unit No.	Length	White		Terratone		Sandtone		Forest Green	
		Left	Right	Left	Right	Left	Right	Left	Right
FWG68	79 ¹³ / ₃₂	By description		By description		By description		By description	
FWG611	82 ⁹ / ₃₂	By description		By description		By description		By description	
FWG80	95 ¹³ / ₃₂	By description		By description		By description		By description	

Jamb - Stationary / Side									
Note: Jambs are handed as viewed from exterior.									
Unit No.	Length	White		Terratone		Sandtone		Forest Green	
		Left	Right	Left	Right	Left	Right	Left	Right
FWG68	79 ¹³ / ₃₂	By description		By description		By description		By description	
FWG611	82 ⁹ / ₃₂	By description		By description		By description		By description	
FWG80	95 ¹³ / ₃₂	By description		By description		By description		By description	

Jamb - Sidelight / Side									
Note: Jambs are handed as viewed from exterior.									
Unit No.	Length	White		Terratone		Sandtone		Forest Green	
		Left	Right	Left	Right	Left	Right	Left	Right
FWG68	79 ¹³ / ₃₂	By description		By description		By description		By description	
FWG611	82 ¹³ / ₃₂	By description		By description		By description		By description	
FWG80	95 ¹³ / ₃₂	By description		By description		By description		By description	

Frame Parts					
Insect Screen Retainer with Screws					
	Note: The insect screen retainer on white units is permanently attached and is not replaceable.	Unit No.	Terratone®	Forest Green	
		PS65/FWG68	2641202	0903430	1262826
		PS68/FWG611	2641204	0903432	1262827
		PS80/FWG80	2653626	0912326	1262828

Trim Piece - Stationary / Side Jamb Ref. No. 10 page 97						
Unit No.	Length	Pine	Maple	Oak	White	
FWG68	77 ⁵ / ₆₄	2573010	2570372	2570366	By description	
FWG611	79 ⁶¹ / ₆₄	2573011	2570373	2570367	By description	
FWG80	93 ⁵ / ₆₄	2573016	2570374	2570368	By description	

Frames

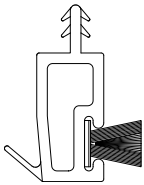
Stops			
Stop - Head Parting / All Sizes Ref. No. 3 page 97			
	Note: Use drilled Head Parting Stop found in Service Replacement section. page 125	Unit No.	Dimensions
		GD29	29 ³ / ₁₆
		GD33	35 ³ / ₁₆
		GD43	47 ³ / ₁₆
		GD50	56 ⁷ / ₁₆
		GD60	68 ⁷ / ₁₆
		GD80	92 ⁷ / ₁₆
		GD100-4	114 ³ / ₁₆
		GD120-4	138 ³ / ₁₆
		GD160-4	186 ³ / ₁₆

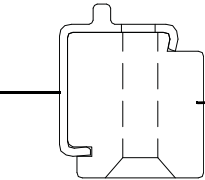
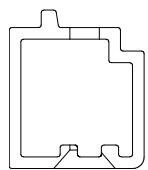
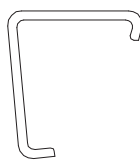
Stop - Inside Head / White Ref. No. 4 page 97									
									
Liner		Stop		Pine, maple, and oak (1993 to Present)		White		Vinyl liner for stops (1987 to 1993)	
Unit No.	No. of Holes	Length	Pine (1987 to 1993)	Pine (1993 to Present)	Maple	Oak	White		
FWG29	4	29 ¹ / ₄	2572427	2572422	2572450	2572441	2572401		
FWG33	5	35 ¹ / ₄	2572428	2572418	2572451	2572442	2572402		
FWG43	6	47 ¹ / ₄	2572429	2572420	2572452	2572443	2572403		
FWG50	7	56 ¹⁵ / ₃₂	2572430	2572424	2572453	2572444	2572404		
FWG60	9	68 ¹⁵ / ₃₂	2572431	2572410	2572454	2572445	2572405		
FWG80	12	92 ¹⁵ / ₃₂	2572432	2572412	2572455	2572446	2572406		
FWG100	14	114 ⁷ / ₃₂	2572433	2572426	2572456	2572447	2572407		
FWG120	17	138 ⁷ / ₃₂	2572434	2572414	2572457	2572448	2572408		
FWG160	23	186 ⁷ / ₃₂	2572435	2572416	2572458	2572449	2572409		

Frenchwood® Gliding Doors (1987 to Present)

2-Panel, 4-Panel, and Stationary

Frames

Stop - Inside Head / Gray Ref. No. 4 [page 97](#)

Note:

Use for Sandtone, Terratone®, and Forest Green units.

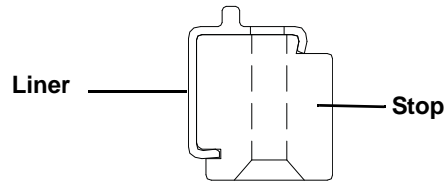

Pine, maple, and oak
(1993 to Present)

	Unit No.	No. of Holes	Length	Pine (1987 to 1993)	Pine (1993 to Present)	Maple	Oak
	FWG29	4	29 1/4	2653422	2653427	2653409	2653399
	FWG33	5	35 1/4	2653418	2653428	2653411	2653401
	FWG43	6	47 1/4	2653420	2653429	2653413	2653402
	FWG50	7	56 15/32	2653424	2653430	2653415	2653403
	FWG60	9	68 15/32	2653410	2653431	2653417	2653404
	FWG80	12	92 15/32	2653412	2653432	2653419	2653405
	FWG100	14	114 7/32	2653426	2653433	2653421	2653406
	FWG120	17	138 7/32	2653414	2653434	2653423	2653407
	FWG160	23	186 7/32	2653416	2653435	2653425	2653408

Screw - Inside Head Stop

Note:

Screws are included with frame screw package in hardware section. Zinc used with natural wood interior.

	Description	Color	Order No.
	1 1/2" x #8, F.H., Steel.	White	1973111
		Sandtone	0904110
		Terratone®	2653861
		Zinc	2579823

Stop - Outside Sidelight / Aluminum

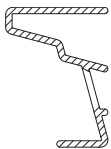

Unit No.	Length	White	Terratone®	Sandtone	Forest Green
FWG68	77 3/16	2565661	2653154	0912222	1267842
FWG611	80 1/16	2565662	2653155	0912223	1267843
FWG80	93 3/16	2565663	2653156	0912224	1267844

Frames

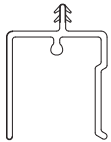
Insect Screen Guide Ref. No. 7 page 97																						
	Note: Use aluminum Insect Screen Guide found in Service Replacement section. page 125	<table border="1"> <thead> <tr> <th>Unit No.</th> <th>Dimensions</th> </tr> </thead> <tbody> <tr> <td>GD29</td> <td>30 1/8</td> </tr> <tr> <td>GD33</td> <td>36 1/8</td> </tr> <tr> <td>GD43</td> <td>48 1/8</td> </tr> <tr> <td>GD50</td> <td>56 13/16</td> </tr> <tr> <td>GD60</td> <td>68 13/16</td> </tr> <tr> <td>GD80</td> <td>92 13/16</td> </tr> <tr> <td>GD100-4</td> <td>114 1/16</td> </tr> <tr> <td>GD120-4</td> <td>138 1/16</td> </tr> <tr> <td>GD160-4</td> <td>186 1/16</td> </tr> </tbody> </table>	Unit No.	Dimensions	GD29	30 1/8	GD33	36 1/8	GD43	48 1/8	GD50	56 13/16	GD60	68 13/16	GD80	92 13/16	GD100-4	114 1/16	GD120-4	138 1/16	GD160-4	186 1/16
		Unit No.	Dimensions																			
		GD29	30 1/8																			
		GD33	36 1/8																			
		GD43	48 1/8																			
		GD50	56 13/16																			
		GD60	68 13/16																			
		GD80	92 13/16																			
		GD100-4	114 1/16																			
		GD120-4	138 1/16																			
GD160-4	186 1/16																					

Head Flashing						
Head Flashing - Sidelight						
	Unit No.	Length	White	Terratone®	Sandtone	Forest Green
	FWG29	32 3/32	2572504	2653506	0912402	1262718
	FWG33	38 3/32	2572506	2653518	0912404	1262719
	FWG43	50 3/32	2572508	2653520	0912406	1262720

Head Flashing - 2-Panel Ref. No. 5 page 97						
	Unit No.	Length	White	Terratone®	Sandtone	Forest Green
	FWG50	59 11/32	1997277	2640720	0903510	By description
	FWG60	71 11/32	2572510	2653510	0912410	1262721
	FWG80	95 11/32	2572512	2653512	0912412	1262722

Head Flashing - 4-Panel Ref. No. 5 page 97						
	Unit No.	Length	White	Terratone®	Sandtone	Forest Green
	FWG100	117 3/32	2572513	2653513	0912414	1262723
	FWG120	141 3/32	2572514	2653514	0912416	1262724
	FWG160	189 3/32	2572516	2653516	0912418	1262725

Installation Flanges			
Windbreak Flange - Head / Sidelight			
	Unit No.	Length	Gray
	FWG29	35 1/4	2572530
	FWG33	41 1/4	2572526
	FWG43	51 1/4	2572528

Frenchwood® Gliding Doors (1987 to Present)

2-Panel, 4-Panel, and Stationary

Frames

Windbreak Flange - Head / 2-Panel Ref. No. 6 page 97			
	Unit No.	Length	Gray
	FWG50	62 ³ / ₈	2640708
	FWG60	74 ³ / ₈	2572518
	FWG80	98 ³ / ₈	2572520

Windbreak Flange - Head / 4-Panel Ref. No. 6 page 97			
	Unit No.	Length	Gray
	FWG100	120 ¹ / ₄	2572534
	FWG120	144 ¹ / ₄	2572522
	FWG160	192 ¹ / ₄	2572524

Windbreak Flange - Side (Pair) Ref. No. 2 page 97			
	Unit No.	Length	Gray
	FWG68	80 ⁵ / ₃₂	2550026
	FWG611	83 ⁵ / ₃₂	2427016
	FWG80	96 ⁵ / ₃₂	2572536

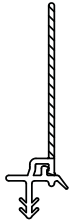
Flange - Folding / Head			
	Unit No.	Length	Order No.
	FWG29	32	9044807
	FWG33	38	9044808
	FWG43	50	9044809
	FWG50-2	59 ¹ / ₄	9044803
	FWG60	71 ¹ / ₄	9044810
	FWG80	95 ¹ / ₄	9044811
	FWGD90	117	9044840
	FWGD1110	141	9044841
	FWGD1510	189	9044843

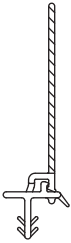
Flange - Folding / Side			
	Unit No.	Length	Order No.
	FWD68	79 ¹ / ₂	9044844
	FWD611	82 ³ / ₈	9044845
	FWD76	89 ¹ / ₂	9046454
	FWD80	95 ¹ / ₂	9044846
	FWD100	119 ¹ / ₂	9044847

Frames

Weatherstrip

Note: As of January 2004, Terratone®, Sandtone, and Forest Green weatherstrip are no longer available. Use Gray weatherstrip for replacement.

Note: May need to order vinyl to vinyl adhesive located in Miscellaneous section.

Note: Weatherstrip for custom sized doors are made to order. Product ID label is located on top edge of operating panel.

To order, state:

1. Description of part (Weatherstrip Set for Frame)
2. Handing (RH or LH)
3. Quantity
4. Product ID

Weatherstrip - Operating / Side Jamb / Outside

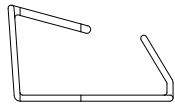
	Unit No.	Length	White		Gray	
			Left	Right	Left	Right
			FWG68	77 ⁵⁷ / ₆₄	2550021	2550046
FWG611	80 ⁴⁹ / ₆₄	1997109	1997110	2641418	2641419	
FWG80	93 ⁵⁷ / ₆₄	2572930	2572931	2641420	2641421	

Weatherstrip - Operating / Side Jamb / Inside

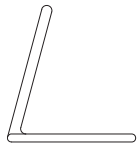
	Unit No.	Length	White	Gray
	FWG68	76 ²¹ / ₃₂	2550020	2641410
	FWG611	79 ¹⁷ / ₃₂	1997108	2641411
	FWG80	92 ²¹ / ₃₂	2572929	2641412

Weatherstrip - Stationary / Side Jamb / Inside Ref. No. 12 [page 97](#)

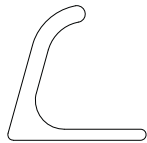
	Unit No.	Length	White	Gray
	FWG68	77 ¹³ / ₁₆	2572926	2641413
	FWG68 Repl 87	77 ¹³ / ₁₆	2572925	N/A
	FWG611	80 ¹¹ / ₁₆	2572904	2641414
	FWG80	93 ¹³ / ₁₆	2572928	2641415

Weatherstrip - Sidelight / Side Jamb

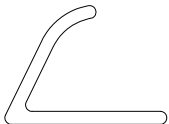
	Unit No.	Length	White	Gray
	FWG68	77 ¹³ / ₁₆	2550022	2641425
	FWG80	93 ¹³ / ₁₆	2572927	2641427

Frenchwood® Gliding Doors (1987 to Present)

2-Panel, 4-Panel, and Stationary

Frames

Sills

Note:

Sills for custom sized doors are made to order. Product ID label is located on top edge of operating panel.

To order, state:

1. Description of part (Sill)
2. Handing (RH or LH)
3. Quantity
4. Product ID

Complete Sill - Sidelight (1990 to Present)

Note:

White refers to the sill filler color, not the actual sill itself.

	Unit No.	Length	White		Gray	
			Left	Right	Left	Right
	FWG29	32	2572144		2653144	
	FWG33	38	2572140		2653140	
	FWG43	50	2572142		2653142	

Complete Sill - 2-Panel (1990 to Present)

Note:

White refers to the sill filler color, not the actual sill itself.

	Unit No.	Length	White		Gray	
			Left	Right	Left	Right
	FWG50	59 1/4	2572146	2572148	2653146	2653148
	FWG60	71 1/4	2572128	2572130	2653128	2653130
	FWG80	95 1/4	2572132	2572134	2653132	2653134

Complete Sill - 4-Panel (1990 to Present) Ref. No. 13 [page 97](#)

Note:

White refers to the sill filler color, not the actual sill itself.

	Unit No.	Length	White		Gray	
			Left	Right	Left	Right
	FWG100	117	2572150		2653150	
	FWG120	141	2572136		2653136	
	FWG160	189	2572138		2653138	

Sill Track Cap - 2-Panel

	Unit No.	Order No.
	FWG50	2573627
	FWG60	2573628
	FWG80	2573630

Frames

Sill Track Cap - 4-Panel Ref. No. 16 page 97		
	Unit No.	Order No.
	FWG100	2573631
	FWG120	2573632
	FWG160	2573634

Sill Support with Screws Ref. No. 17 page 97		
	Order No.	Gray
	PD30	1997055
	PD40	1997056
	PD50	1997054
	PD60	1997057
	PD80	1997058
	PD90	1997059
	PD100	2573218
	PD120	1997060
	PD160	2573216
	PD510	2550011

Frenchwood® Gliding Doors (1987 to Present)

2-Panel, 4-Panel, and Stationary

Frames

Filler

Filler with Screws - Sidelight / Bottom Rail

Note:

Terratone® and Sandtone filler are no longer available. Use gray for Terratone® and Sandtone units.

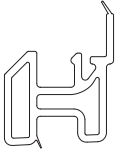
		Unit No.	Length	White	Gray
		FWG29	30"	N/A	2402057
		FWG33	36"	8293601	8293602
		FWG43	48"	8293603	8293604

Filler with Screws - Stationary / Bottom Rail Ref. No. 14 [page 97](#)

Unit No.	Dimensions	White		Gray	
		Left	Right	Left	Right
GD26	29 ⁷ / ₈	2572704	2572706	0912608	0912610
GD30/FWG30	35 ⁷ / ₈	2572708	2572710	0912612	0912614
GD40/FWG40	47 ⁷ / ₈	2572712	2572714	0912616	0912618

End Cap - Bottom Rail Filler

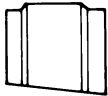
	<p>Note: Gray used as replacement for Sandtone and Forest Green.</p>	Color	Order No.	
			Left	Right
		White	2573870	2573872
		Terratone®	2653840	2653842
Gray	1997025	1997026		

Retainer - Rail Filler / Center Ref. No. 15 [page 97](#)

	<p>Note: The center rail filler retainer is no longer available. Replace with bottom rail filler, above.</p>	Order No.
		N/A

Retainer - Rail Filler / Center Ref. No. 15 [page 97](#)

	<p>Note: The center rail filler retainer is no longer available. Replace with bottom rail filler, above.</p>	Order No.
		N/A

Frames

Frame Parts and Hardware

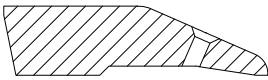
Threshold with Screws Ref. No. 19 page 97					
		Unit No.	Length	Maple	Oak
		FWG29/30/33	40"	1207056	1207010
		FWG43	52"	1207057	1207020
		FWG50	63"	1207058	1207025
		FWG60	74"	1207059	1207030
		FWG80	98"	1207060	1207040
		FWG100//4	120"	1207062	1207048
		FWG120/4	145"	1207063	1207050
	FWG160/4	193"	1207064	1207055	

Screw Package - Threshold / 3/4		
	Package includes: 3 screws	Order No. 1277102

Screw Package - Threshold / 5/6		
	Package includes: 5 screws	Order No. 1277104

Screw Package - Threshold / 8/9		
	Package includes: 7 screws	Order No. 1277106

Screw Package - Threshold / 10/12		
	Package includes: 9 screws	Order No. 1277108

Screw Package - Threshold / 15		
	Package includes: 13 screws	Order No. 1277110

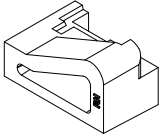
Plug - Sill (1990 to Present)			
	Note: Use foam plug at bottom of interlock.	Left	Right
		2573874	2573876

Frenchwood® Gliding Doors (1987 to Present)

2-Panel, 4-Panel, and Stationary

Frames

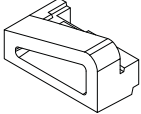
Plug - Sill (1987 to 1990)			
	Note: Use foam plug at bottom of interlock.	Left	Right
		2573618	2573616

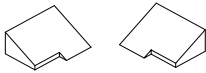
Plug - Operator Side Jamb Ref. No. 11 page 97			
		Left	Right
		2640832	2640834

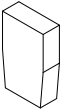
Foam Block - Parting Stop End		
	Note: Use on end of lock jamb.	Order No.
		2573626

Plug - Head Foam		
	Note: Use on top of interlock weatherstrip on stationary panel.	Order No.
		2573624

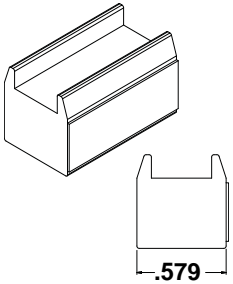
Plug - Head Foam		
	Note: Use on top of interlock weatherstrip on stationary panel. Used on factory assembled units.	Order No.
		By description

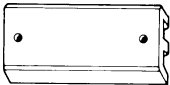
Head Bumper with Screws - 2-Panel			
	Note: Use on 4-panels units also.	Color	Order No.
		White	1997083
		Gray	2640012

Frames

Extension Jamb

Note:

See [Accessory Guide 0005474](#).

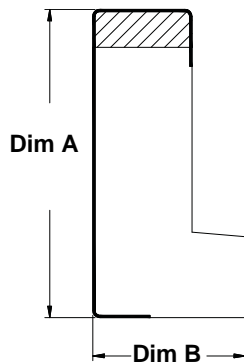

	Dim A	Dim B
5 1/4	0.720	1.000
6 9/16	2.032	1.000
7 1/8	2.595	1.000

Extension Jamb - Head Kit / Pine

	Unit No.	5 1/4" Wall	6 9/16" Wall	7 1/8" Wall
	GD29S	2567213	2567222	2567231
	GD33S	2567214	2567223	2567232
	GD43S	2567215	2567224	2567233
	GD50	2567216	2567225	2567234
	GD60	2567217	2567226	2567235
	GD80	2567218	2567227	2567236
	GD100 4 PAN	2567219	2567228	2567237
	GD120 4 PAN	2567220	2567229	2567238
	GD160 4 PAN	2567221	2567230	2567239

Extension Jamb - Head Kit / Maple

	Unit No.	5 1/4" Wall	6 9/16" Wall	7 1/8" Wall
	GD29S	2567267	2567276	2567285
	GD33S	2567268	2567277	2567286
	GD43S	2567269	2567278	2567287
	GD50	2567270	2567279	2567288
	GD60	2567271	2567280	2567289
	GD80	2567272	2567281	2567290
	GD100 4 PAN	2567273	2567282	2567291
	GD120 4 PAN	2567274	2567283	2567292
	GD160 4 PAN	2567275	2567284	2567293

Frenchwood® Gliding Doors (1987 to Present)

2-Panel, 4-Panel, and Stationary

Frames

Extension Jamb - Head Kit / Oak				
	Unit No.	5 1/4" Wall	6 9/16" Wall	7 1/8" Wall
	GD29S	2567240	2567249	2567258
	GD33S	2567241	2567250	2567259
	GD43S	2567242	2567251	2567260
	GD50	2567243	2567252	2567261
	GD60	2567244	2567253	2567262
	GD80	2567245	2567254	2567263
	GD100 4 PAN	2567246	2567255	2567264
	GD120 4 PAN	2567247	2567256	2567265
	GD160 4 PAN	2567248	2567257	2567266

Extension Jamb - Head Kit / Painted White				
	Unit No.	5 1/4" Wall	6 9/16" Wall	7 1/8" Wall
	GD29S	2567322	2567331	2567340
	GD33S	2567323	2567332	2567341
	GD43S	2567324	2567333	2567342
	GD50	2567325	2567334	2567343
	GD60	2567326	2567335	2567344
	GD80	2567327	2567336	2567345
	GD100 4 PAN	2567328	2567337	2567346
	GD120 4 PAN	2567329	2567338	2567347
	GD160 4 PAN	2567330	2567339	2567348

Extension Jamb - Head Kit / Vinyl White Interior				
	Unit No.	5 1/4" Wall	6 9/16" Wall	7 1/8" Wall
	GD29S	2567294	2567304	2567313
	GD33S	2567295	2567305	2567314
	GD43S	2567296	2567306	2567315
	GD50	2567297	2567307	2567316
	GD60	2567298	2567308	2567317
	GD80	2567299	2567309	2567318
	GD100 4 PAN	2567301	2567310	2567319
	GD120 4 PAN	2567302	2567311	2567320
	GD160 4 PAN	2567303	2567312	2567321

Frames

Extension Jamb - Side Kit / Pine (Pair)				
	Unit No.	5 1/4" Wall	6 9/16" Wall	7 1/8" Wall
	GD68	2567349	2567364	2567379
	GD611	2567350	2567365	2567380
	GD80	2567351	2567366	2567381

Extension Jamb - Side Kit / Maple (Pair)				
	Unit No.	5 1/4" Wall	6 9/16" Wall	7 1/8" Wall
	GD68	2567355	2567370	2567385
	GD611	2567356	2567371	2567386
	GD80	2567357	2567372	2567387

Extension Jamb - Side Kit / Oak (Pair)				
	Unit No.	5 1/4" Wall	6 9/16" Wall	7 1/8" Wall
	GD68	2567352	2567367	2567382
	GD611	2567353	2567368	2567383
	GD80	2567354	2567369	2567384

Extension Jamb - Side Kit / Painted White (Pair)				
	Unit No.	5 1/4" Wall	6 9/16" Wall	7 1/8" Wall
	GD68	2567361	2567376	2567391
	GD611	2567362	2567377	2567392
	GD80	2567363	2567378	2567393

Extension Jamb - Side Kit / Vinyl White Interior (Pair)				
	Unit No.	5 1/4" Wall	6 9/16" Wall	7 1/8" Wall
	GD68	2567358	2567373	2567388
	GD611	2567359	2567374	2567389
	GD80	2567360	2567375	2567390

Frenchwood® Gliding Doors (1987 to Present)

2-Panel, 4-Panel, and Stationary

Frames

Sill Ramp Parts

Insert Kit - Sill Ramp

Note:
See [Accessory Guide 0004392](#).

	Kit includes: Center ramp, interior ramp, exterior ramp, track cover	Unit No.	Maple	Oak
		FWG50	2572190	2572160
		FWG60	2572191	2572161
		FWG80	2572192	2572162
		FWG100	2572194	2572163
		FWG120	2572195	2572164
		FWG160	2572196	2572165

Sill Ramp

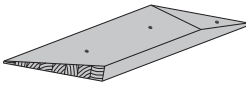
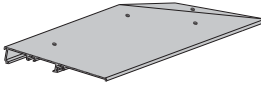
		Interior		Exterior	
					
Unit No.	Maple	Oak	Unit No.	Order No.	
FWG50	2572197	2572166	FWG50	2572172	
FWG60	2572198	2572167	FWG60	2572173	
FWG80	2572199	2572168	FWG80	2572174	
FWG100	2572202	2572169	FWG100	2572175	
FWG120	2572203	2572170	FWG120	2572176	
FWG160	2572204	2572171	FWG160	2572177	

Sill Ramp - Center

	Unit No.	Order No.
	FWG50	2572178
	FWG60	2572179
	FWG80	2572180
	FWG100	2572181
	FWG120	2572182
	FWG160	2572183

Track Cover - Sill Ramp

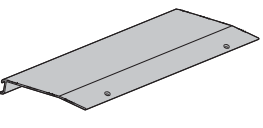
	Unit No.	Order No.
	FWG50	2572184
	FWG60	2572185
	FWG80	2572186
	FWG100	2572187
	FWG120	2572188
	FWG160	2572189

Frames

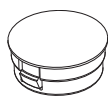
Fasteners					
Screw Package - Frame / Sidelight					
Unit No.	White	Terratone®	Sandtone	Forest Green	Prefinished Interior White
FWG29/33/43	2573653	2653825	0912802	1262831	2573653
Screw Package - Frame / 2- and 4-Panel					
Unit No.	White	Terratone®	Sandtone/ Forest Green	Prefinished Interior White	
FWG5068/6116068/611	2573654	2653826	0912804	2573671	
FWG5080/6080/8080	2573655	2653827	0912805	2573672	
FWG100/12068/611	2573656	2653828	0912806	2573674	
FWG16068/160611	2573657	2653829	0912807	2573676	
FWG10080/12080	2573663	2653831	0912801	2573675	
FWG16080	2573664	2653832	0912803	2573677	
Screw Package - Frame / Corrosion Resistant / 2- and 3-Panel					
					Order No.
					1973106
Screw Package - Frame / Corrosion Resistant / Sidelight					
					Order No.
					1973104
Screw Package - Factory Assembled Units					
Note: Hole plug included for prefinished white units		Package Includes: 13 - 2-1/2" x #10 screws 4 - Hole plugs 1 - Insect screen latch 1 - 1" x #8 screw			
	White	Terratone®	Sandtone	Forest Green	Prefinished Interior White
	2573491	2653872	0912821	1260162	2573495
Cover - Frame Hole Plugs					
Note: See Service Guide 9013354 .					
	Note: Kit includes 9 hole plugs.			Color	Order No.
				White	9014046
				Terratone	9014048
				Sandtone	9014047

Frenchwood® Gliding Doors (1987 to Present)

2-Panel, 4-Panel, and Stationary

Joining Components

Joining Components - Narrow Mullion

1. Exterior Trim Strip, Notched and Beveled at Sill
2. Interior Trim Strip
3. Screws, #10 x 1 5/8" and #10 x 1"
4. Mullion Head Flashing

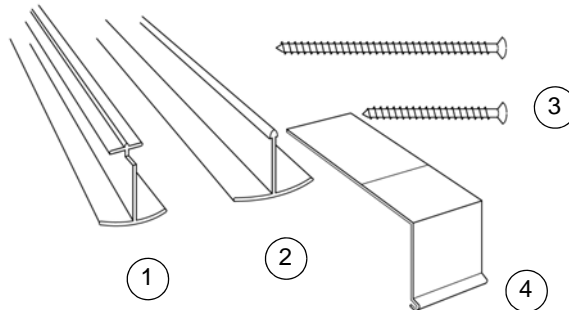

Frenchwood® Gliding Narrow Mullion

Note:

Interior Trim Strip # 2 is not included with Frenchwood Gliding Door Kit. See [Installation Guide 0000665](#).

Joining Kit - Narrow Mullion

Unit No.	Length	White	Terratone®	Sandtone	Forest Green
FWG68	78 7/32	2510114	2620004	0911206	1262821
FWG611	81 3/32	2510215	2620109	0911207	1262822
FWG80	94 7/32	2510116	2620010	0911208	1262823

Trim Strip - Outside Vinyl Ref. No. 1

Unit No.	Length	White	Terratone®	Sandtone	Forest Green
FWG68	78 7/32	1970927	2640740	0903747	1262845
FWG611	81 3/32	1970928	2640741	0903748	1262846
FWG80	94 7/32	2510220	2652907	0912419	1262847

Mull Casing - Inside - Pine - 2 5/8"

Note:

Interior casing does not ship with FWG joining kit.

Length	Pine
96"	1386812
144"	1386814

Head Flashing Ref. No. 4

Unit No.	Length	White	Terratone®	Sandtone
All Units	2 1/2	1997264	2640728	0903522

Screw Ref. No. 3

Description	White	Terratone®	Sandtone	Gray
8 - #10 x 1 5/8" screws	3620649	3620646	3620648	3629021

Screw Ref. No. 3 page 117

Description	Order No.
1 - # 8 x 1" security screw	3621530

Joining Components

Joining Components - LVL* Reinforced

Note:

* Laminated Veneered Lumber (LVL).

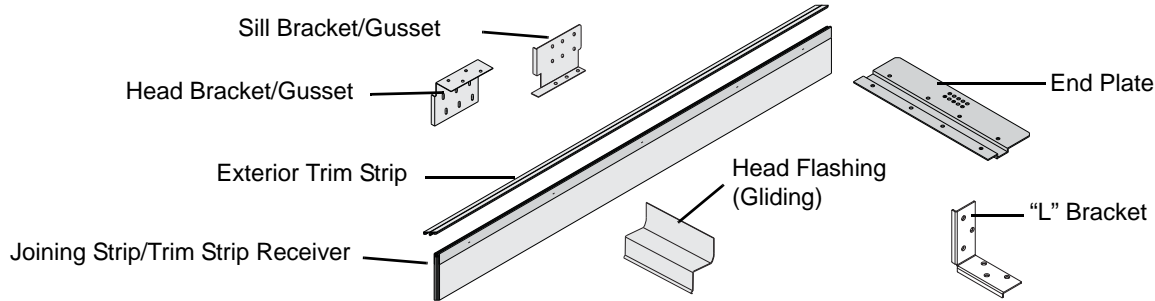

Joining Component - LVL Reinforced / 3/4" / Vertical and Horizontal / Standard Wall

Kit Includes:

LVL joining strip, exterior trim strip, head brackets, sill brackets, flashing, and screw pack.

Unit No.	Length	White	Terratone®	Sandtone	Forest Green
68	79 ⁹ / ₃₂	2510216	2620110	0900409	1262863
611	82 ⁵ / ₃₂	2510217	2620111	0900410	1262864
80	95 ⁹ / ₃₂	2510218	2620112	0900411	1262865
10 ft	117 ³ / ₄	2510223	2620116	0900415	1262830

Joining Component - LVL Reinforced / 3/4" / Vertical and Horizontal / 7 9/16" Wall

Kit Includes:

LVL joining strip, exterior trim strip, head brackets, sill brackets, flashing, and screw pack.

Unit No.	Length	White	Terratone®	Sandtone	Forest Green
10 ft	117 ³ / ₄	2510224	2620117	0900416	1262832

Trim Strip - LVL Reinforced / Exterior / 3/4"

Unit No.	Length	White	Terratone®	Sandtone	Forest Green
68	79 ¹ / ₂	2573492	2640743	0903750	1262848
611	82 ¹ / ₈	2573496	2640744	0903751	1262849
80	95 ¹ / ₄	2573488	2640745	0903752	1262850
10 ft	117 ¹³ / ₁₆	2510101	2640746	0903753	1262851

Flashing - LVL Reinforced / Exterior Support Mullion / 4 5/8"

	Color	Order No.
	White	1997266
	Terratone®	2640729
	Sandtone	0903524
	Forest Green	1262727

Frenchwood® Gliding Doors (1987 to Present)

2-Panel, 4-Panel, and Stationary

Joining Components

Head Bracket - LVL Reinforced / 3/4"		
	Length	Order No.
	3 7/8	2573482
Sill Bracket and Gusset - LVL Reinforced / 3/4"		
	Length	Order No.
	4	2573483

"L" Bracket - LVL Reinforced / 3/4"		
	Length	Order No.
	4 9/16	1601635

End Plate - LVL Reinforced / Narrow Joining				
			Order No.	
			2579992	
Inside Casing - LVL Reinforced / 3/4" and Narrow Mullion / 2 3/8"				
	Note: Inside casing is not part of LVL joining kit.	Length	Finish	Order No.
96		White (Vinyl)	1916008	
		Pine	1916007	
		Maple	1916010	
		Oak	1916009	
80		Sandtone	9069014	
		Terratone	9069015	
		Forest Green	9069016	
120		White	1916002	
		Pine	1916001	
		Maple	1916004	
		Oak	1916003	

Joining Components

Joining Components - Support Mullion

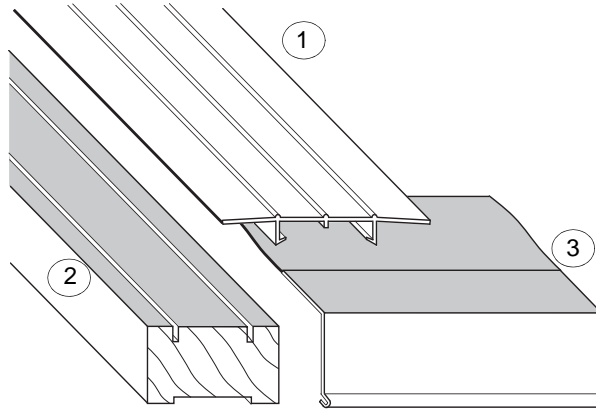

1. Outside Vinyl Trim Strip
2. Filler
3. Head Flashing

Frenchwood® Gliding Support Mullion

Joining Kit - Support Mullion

Kit includes:

Outside vinyl trim strip, filler, flashing and fasteners.

Unit No.	Length	White	Terratone®	Sandtone	Forest Green
FWG68	79 ⁷ / ₁₆	2510212	2620103	0900406	1262824
FWG611	82 ⁵ / ₁₆	1916512	2460204	0900408	1262829
FWG80	95 ⁷ / ₁₆	2510214	2620108	0911210	1262825

Trim Strip - Support Mullion / Outside Vinyl Ref. No. 1

Unit No.	Length	White	Terratone®	Sandtone	Forest Green
FWG68	79 ⁷ / ₁₆	1970929	2668706	0924706	1267804
FWG611	82 ⁵ / ₁₆	1970930	2668707	0924707	1267805
FWG80	95 ⁷ / ₁₆	2579708	2668708	0924708	1267806

Filler - Support Mullion Ref. No. 2

	Unit No.	Length	Order No.
	FWG68	79 ⁷ / ₁₆	2579714
	FWG611	82 ⁵ / ₁₆	2579715
	FWG80	95 ⁷ / ₁₆	2579716

Head Flashing - Support Mullion Ref. No. 3

	Unit No.	Length	Color	Order No.
	All Units	4 ³ / ₈	White	1997266
			Terratone®	2640729
			Sandtone	0903524

Frenchwood® Gliding Doors (1987 to Present)

2-Panel, 4-Panel, and Stationary

Joining Components

Universal Drip Cap - Continuous

Note:

Use on side-by-side or vertical joins mulled at the factory or distributor. Consists of 24 gauge aluminum material.

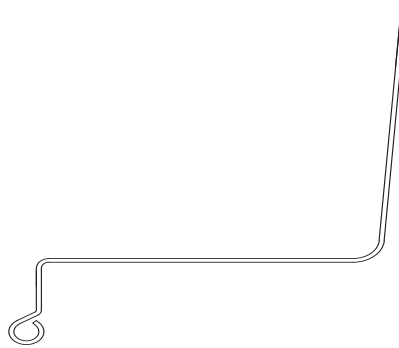

	72"			120"			151 1/2"	
	Package Quantity			Package Quantity			Package Quantity	
	1	10	40	1	10	40	1	10
White	2222525	2222526	2222527	2222546	2222547	2222548	2222555	2222556
Terratone®	2222528	2222529	N/A	2222549	2222550	N/A	2222557	2222558
Sandtone	2222530	2222531	N/A	2222551	2222552	N/A	2222559	2222560
Forest Green	2222532	2222533	N/A	2222553	2222554	N/A	2222561	2222562
Canvas	9003116	9003117	N/A	9003126	9003127	N/A	9003130	9003131

Art Glass Components

Trim Stops - Art Glass

Note:

For stationary sidelights only. Art glass can not be installed on operating panels. Information about ordering replacement art glass panels can be found in the Andersen® Art Glass™ section of the catalog.

Trim Stop - Art Glass / Head and Sill

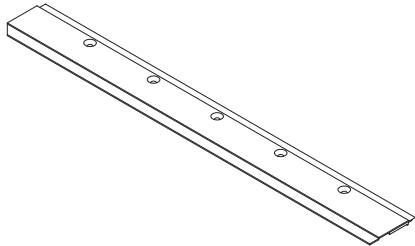
		Unit No.	Length	Order No.
		AGFWG26	20 9/16	2370181
		AGFWG30	26 9/16	2370182
		AGFWG40	38 9/16	2370183

Trim Stop - Art Glass / Side

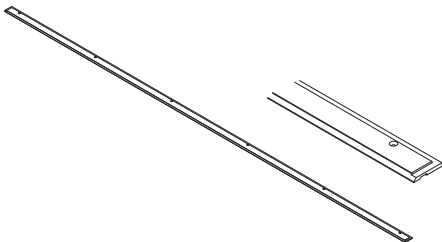
		Unit No.	Length	Order No.
		AGFWG68	65 1/8	2370186
		AGFWG80	67 15/16	2370187
		AGFWG611	81 1/8	2370188

Art Glass Hardware

Bracket Package with Shims and Screws - Art Glass / Top and Bottom

	Unit No.	Order No.
	AG FWD	2370019

Bracket with Screws - Art Glass / Top

	Order No.
	2370024

Screw - Art Glass

	Description	Order No.
	Brass oval head package, AG 1x5 STD	2370026

Screw - Art Glass / Sill Stop Package

	Description	Order No.
	AG 5X9/16 FWD/PSC	2370029

Stormwatch® Protection (Coastal Product)

Note:

Andersen® products with Stormwatch protection are designed for use in coastal areas. They feature design pressure upgrades, glass options, and structural enhancements. The parts in this section have moved to the Service Replacement section on [page 128](#).

Parts shared with standard doors are listed in the standard product pages of the section.

Notes

Frenchwood® Gliding Doors (1987 to Present)

Service Replacement

Service Replacement Only Parts

Insect Screen Guide - Predrilled / Aluminum

Insect Screen Guide - Sidelight / Predrilled / Aluminum

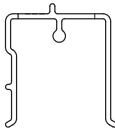
	Unit No.	# Screw Holes	Length	White	Gray	Forest Green
	FWG29	4	30 1/8	2572621	2653621	N/A
	FWG33	5	36 1/8	2572622	2653622	N/A
	FWG43	6	48 1/8	2572624	2653624	N/A

Insect Screen Guide - 2-Panel / Predrilled / Aluminum

	Unit No.	# Screw Holes	Length	White	Gray	Forest Green
	FWG50	7	56 13/16	2562325	2641715	1262870
	FWG60	9	68 13/16	2562334	2641724	1262871
	FWG80	12	92 13/16	2562335	2641725	1262872

Insect Screen Guide - 4-Panel / Predrilled / Aluminum Ref. No. 3 [page 97](#)

	Unit No.	# Screw Holes	Length	White	Gray	Forest Green
	FWG100	14	114 1/16	2562336	2641726	1262873
	FWG120	17	138 1/16	2562337	2641727	1262874
	FWG160	23	186 1/16	2562338	2641728	1262875

Screw - Insect Screen Guide

	Color	Order No.
	White	2500702
	Gray	2500704
	Terratone®	2653862

Stops with Screws - Head Parting / Predrilled

Stop with Screws - Head Parting / Predrilled / Sidelight

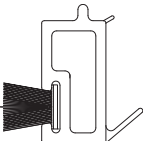
		Unit No.	Fasteners/ Screw Used	Length	White	Gray
		GD29	4	29 3/16	2572339	2653348
		GD33	5	35 3/16	2572340	2653349
		GD43	6	47 3/16	2572341	2653350

Service Replacement Only Parts

Stop with Screws - Head Parting / Predrilled / 2-Panel Ref. No. 7 page 97					
	Unit No.	Fasteners/ Screw Used	Length	White	Gray
	GD50	7	56 ⁷ / ₁₆	1970919	2640519
	GD60	9	68 ⁷ / ₁₆	2572342	2653351
	GD80	12	92 ⁷ / ₁₆	2572343	2653352
	FWG100-4	14	114 ³ / ₁₆	2572344	2653353
	FWG120-4	17	138 ³ / ₁₆	2572345	2653354
	FWG160-4	23	186 ³ / ₁₆	2572346	2653355

Screw - Head Parting Stop		
	Color	Order No.
	White	2565702
	Gray	2653797

Head Panel Spacers			
Head Panel Spacers			
	Length	Color	Order No.
	4 ft	White	2573888
		Terratone®	2653744
		Sandtone	N/A
		Forest Green	1262840

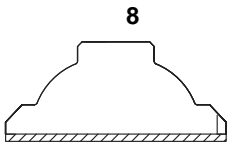
Exterior Grilles - HDN									
Exterior Grille - HDN / Lineal / PVC									
Note: These grilles can only be ordered by SAR/SPC.									
									
Length	White			Terratone®			Sandtone		
	3/4"	7/8"	1 1/8"	3/4"	7/8"	1 1/8"	3/4"	7/8"	1 1/8"
60 in	2322030	2322034	2322038	2322101	2322103	2322105	2322032	2322036	2322040
84 in	2322031	2322035	2322039	2322102	2322104	2322106	2322033	2322037	2322041

Frenchwood® Gliding Doors (1987 to Present)

Service Replacement

Service Replacement Only Parts

Miscellaneous Hardware Parts

Gear Kit - Keyed Lock / Exterior

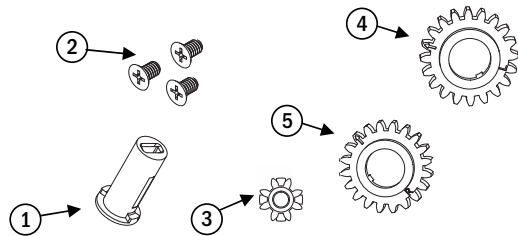

Kit includes:

- 1 1 - Tailpiece Receiver
- 2 3 - Screws - #8-32UNC x 9/32, PH FL Undercut Mach
- 3 1 - Small gear
- 4 1- LH Large gear
- 5 1- RH Large gear

See [Service Guide 0005386](#).

Order No.

2500707

Aluminum Covers

Aluminum Cover

Note:

Aluminum Covers are not available.

Panel Snugger

Panel Snugger with Washer

Natural

1913005

Washer - Snugger

Description

#8 countersunk finishing

Order No.

N/A

Cartons

Cartons - Unit

Note:

To ship via van only.

Unit No.

Order No.

FWG5068/611

4756701

FWG6068/611

4756702

FWG8068/611

4756703

Service Replacement Only Parts

Panels - Operating / Stormwatch®

Note:

Impact resistant High-Performance Sun II Tempered, Gray Laminated Monolithic panels, and Clear Laminated Monolithic panels are available by description.

Panel - Operating / High-Performance Tempered (Impact Resistant) / Pine Interior

	Unit No.	Pine Interior/ White Exterior	Pine Interior/ Terratone® Exterior	Pine Interior/ Sandtone Exterior	Pine Interior/ Forest Green Exterior
	FWG2668	By description	By description	By description	By description
	FWG26611	By description	By description	By description	By description
	FWG2680	By description	By description	By description	By description
	FWG3068	2560522	By description	By description	By description
	FWG30611	2560524	By description	By description	By description
	FWG3080	2560526	By description	0910512	By description
	FWG4068	2560528	By description	By description	By description
	FWG40611	2560530	By description	By description	By description
	FWG4080	2560532	By description	By description	By description

Panel - Operating / High-Performance Tempered (Impact Resistant) / Maple Interior

	Unit No.	Maple Interior/ White Exterior	Maple Interior/ Terratone® Exterior	Maple Interior/ Sandtone Exterior	Maple Interior/ Forest Green Exterior
	FWG2668	By description	By description	By description	By description
	FWG26611	By description	By description	By description	By description
	FWG2680	By description	By description	By description	By description
	FWG3068	By description	By description	By description	By description
	FWG30611	By description	By description	By description	By description
	FWG3080	By description	By description	By description	By description
	FWG4068	By description	By description	By description	By description
	FWG40611	By description	By description	By description	By description
	FWG4080	By description	By description	By description	By description

Frenchwood® Gliding Doors (1987 to Present)

Service Replacement

Service Replacement Only Parts

Panel - Operating / High-Performance Tempered (Impact Resistant) / Oak Interior					
	Unit No.	Oak Interior/ White Exterior	Oak Interior/ Terratone® Exterior	Oak Interior/ Sandtone Exterior	Oak Interior/ Forest Green Exterior
	FWG2668	By description	By description	By description	By description
	FWG26611	By description	By description	By description	By description
	FWG2680	By description	By description	By description	By description
	FWG3068	By description	By description	By description	By description
	FWG30611	By description	By description	By description	By description
	FWG3080	By description	By description	By description	By description
	FWG4068	By description	By description	By description	By description
	FWG40611	By description	By description	By description	By description
	FWG4080	By description	By description	By description	By description
Panel - Operating / High-Performance Tempered (Impact Resistant) / Prefinished Interior White					
	Unit No.	Prefinished White Interior/ White Exterior			
	FWG2668	2560533			
	FWG26611	By description			
	FWG2680	By description			
	FWG3068	2560539			
	FWG30611	2560541			
	FWG3080	2560543			
	FWG4068	By description			
	FWG40611	By description			
	FWG4080	By description			
Panel - Operating / High-Performance Sun 3 Tempered / Pine Interior					
	Unit No.	Pine Interior/ White Exterior	Pine Interior/ Terratone® Exterior	Pine Interior/ Sandtone Exterior	Pine Interior/ Forest Green Exterior
	FWG2668	By description	By description	By description	By description
	FWG26611	By description	By description	By description	By description
	FWG2680	By description	By description	By description	By description
	FWG3068	By description	By description	By description	By description
	FWG30611	By description	By description	By description	By description
	FWG3080	By description	By description	By description	By description
	FWG4068	By description	By description	By description	By description
	FWG40611	By description	By description	By description	By description
	FWG4080	By description	By description	0910536	By description

Service Replacement Only Parts

Panel - Operating / High-Performance Sun 3 Tempered / Maple Interior					
	Unit No.	Maple Interior/ White Exterior	Maple Interior/ Terratone® Exterior	Maple Interior/ Sandtone Exterior	Maple Interior/ Forest Green Exterior
	FWG2668	By description	By description	By description	By description
	FWG26611	By description	By description	By description	By description
	FWG2680	By description	By description	By description	By description
	FWG3068	By description	By description	By description	By description
	FWG30611	By description	By description	By description	By description
	FWG3080	By description	By description	By description	By description
	FWG4068	By description	By description	By description	By description
	FWG40611	By description	By description	By description	By description
	FWG4080	By description	By description	By description	By description
Panel - Operating / High-Performance Sun 3 Tempered / Oak Interior					
	Unit No.	Oak Interior/ White Exterior	Oak Interior/ Terratone® Exterior	Oak Interior/ Sandtone Exterior	Oak Interior/ Forest Green Exterior
	FWG2668	By description	By description	By description	By description
	FWG26611	By description	By description	By description	By description
	FWG2680	By description	By description	By description	By description
	FWG3068	By description	By description	By description	By description
	FWG30611	By description	By description	By description	By description
	FWG3080	By description	By description	By description	By description
	FWG4068	By description	By description	By description	By description
	FWG40611	By description	By description	By description	By description
	FWG4080	By description	By description	By description	By description
Panel - Operating / High-Performance Sun 3 Tempered / Prefinished Interior White					
	Unit No.	Prefinished Interior White/ White Exterior			
	FWG2668	By description			
	FWG26611	By description			
	FWG2680	By description			
	FWG3068	By description			
	FWG30611	By description			
	FWG3080	By description			
	FWG4068	By description			
	FWG40611	By description			
	FWG4080	By description			

Frenchwood® Gliding Doors (1987 to Present)

Service Replacement

Service Replacement Only Parts

Operating Panel Parts/ Stormwatch®

Filler with Weatherstrip - Bottom Rail

	Unit No.	Length	White	Gray	Sandtone	Forest Green
	FWG26	30	2572715	2653715	N/A	N/A
	FWG30	36	2572717	2653717	N/A	N/A
	FWG40	48	2572719	2653719	N/A	N/A

Stiffener - Operating / Side (Impact Resistant)

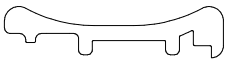
	Unit No.	Length	Pine	Maple	Oak	Prefinished Interior White
	FWG68	76 ⁵ / ₃₂	2565649	2565646	2565655	2565652
	FWG611	79 ¹ / ₃₂	2565650	2565647	2565656	2565653
	FWG80	92 ⁵ / ₃₂	2565651	2565648	2565657	2565654

Screw Package - Stiffener (Impact Resistant)

	Color	Order No.
	White	By description
	Terratone®	By description
	Sandtone	By description
	Forest Green	By description

Tandem Roller (1998 to Present)

	Description	Order No.
	DP upgrade	2573517

Service Replacement Only Parts

Panels - Stationary / Stormwatch®

Note:

Impact resistant High-Performance Sun II Tempered, Gray Laminated Monolithic panels, and Clear Laminated Monolithic panels are available by description.

Panel - Stationary / High-Performance Tempered (Impact Resistant) / Pine Interior

	Unit No.	Pine Interior/ White Exterior	Pine Interior/ Terratone® Exterior	Pine Interior/ Sandtone Exterior	Pine Interior/ Forest Green Exterior
	FWG2668	2560515	By description	By description	By description
	FWG26611	By description	By description	By description	By description
	FWG2680	By description	By description	By description	By description
	FWG3068	2560521	By description	By description	By description
	FWG30611	2560523	By description	By description	By description
	FWG3080	2560525	By description	0910511	By description
	FWG4068	2560527	By description	By description	By description
	FWG40611	2560529	By description	By description	By description
	FWG4080	2560531	By description	By description	By description

Panel - Stationary / High-Performance Tempered (Impact Resistant) / Maple Interior

	Unit No.	Maple Interior/ White Exterior	Maple Interior/ Terratone® Exterior	Maple Interior/ Sandtone Exterior	Maple Interior/ Forest Green Exterior
	FWG2668	By description	By description	By description	By description
	FWG26611	By description	By description	By description	By description
	FWG2680	By description	By description	By description	By description
	FWG3068	By description	By description	By description	By description
	FWG30611	By description	By description	By description	By description
	FWG3080	By description	By description	By description	By description
	FWG4068	By description	By description	By description	By description
	FWG40611	By description	By description	By description	By description
	FWG4080	By description	By description	By description	By description

Frenchwood® Gliding Doors (1987 to Present)

Service Replacement

Service Replacement Only Parts

Panel - Stationary / High-Performance Tempered (Impact Resistant) / Oak Interior					
	Unit No.	Oak Interior/ White Exterior	Oak Interior/ Terratone® Exterior	Oak Interior/ Sandtone Exterior	Oak Interior/ Forest Green Exterior
	FWG2668	By description	By description	By description	By description
	FWG26611	By description	By description	By description	By description
	FWG2680	By description	By description	By description	By description
	FWG3068	By description	By description	By description	By description
	FWG30611	By description	By description	By description	By description
	FWG3080	By description	By description	By description	By description
	FWG4068	By description	By description	By description	By description
	FWG40611	By description	By description	By description	By description
	FWG4080	By description	By description	By description	By description

Panel - Stationary / High-Performance Tempered (Impact Resistant) / Prefinished Interior White		
	Unit No.	Prefinished Interior White/ White Exterior
	FWG2668	2560534
	FWG26611	By description
	FWG2680	By description
	FWG3068	2560540
	FWG30611	2560542
	FWG3080	2560544
	FWG4068	By description
	FWG40611	By description
	FWG4080	By description

Panel - Stationary / High-Performance Sun 3 Tempered / Pine Interior					
	Unit No.	Pine Interior/ White Exterior	Pine Interior/ Terratone® Exterior	Pine Interior/ Sandtone Exterior	Pine Interior/ Forest Green Exterior
	FWG2668	By description	By description	By description	By description
	FWG26611	By description	By description	By description	By description
	FWG2680	By description	By description	By description	By description
	FWG3068	By description	By description	By description	By description
	FWG30611	By description	By description	By description	By description
	FWG3080	By description	By description	By description	By description
	FWG4068	By description	By description	By description	By description
	FWG40611	By description	By description	By description	By description
	FWG4080	By description	By description	0910535	By description

Service Replacement Only Parts

Panel - Stationary / High-Performance Sun 3 Tempered / Maple Interior					
	Unit No.	Maple Interior/ White Exterior	Maple Interior/ Terratone® Exterior	Maple Interior/ Sandtone Exterior	Maple Interior/ Forest Green Exterior
	FWG2668	By description	By description	By description	By description
	FWG26611	By description	By description	By description	By description
	FWG2680	By description	By description	By description	By description
	FWG3068	By description	By description	By description	By description
	FWG30611	By description	By description	By description	By description
	FWG3080	By description	By description	By description	By description
	FWG4068	By description	By description	By description	By description
	FWG40611	By description	By description	By description	By description
	FWG4080	By description	By description	By description	By description

Panel - Stationary / High-Performance Sun 3 Tempered / Oak Interior					
	Unit No.	Oak Interior/ White Exterior	Oak Interior/ Terratone® Exterior	Oak Interior/ Sandtone Exterior	Oak Interior/ Forest Green Exterior
	FWG2668	By description	By description	By description	By description
	FWG26611	By description	By description	By description	By description
	FWG2680	By description	By description	By description	By description
	FWG3068	By description	By description	By description	By description
	FWG30611	By description	By description	By description	By description
	FWG3080	By description	By description	By description	By description
	FWG4068	By description	By description	By description	By description
	FWG40611	By description	By description	By description	By description
	FWG4080	By description	By description	By description	By description

Panel - Stationary / High-Performance Sun 3 Tempered / Prefinished Interior White		
	Unit No.	Prefinished Interior White/ White Exterior
	FWG2668	By description
	FWG26611	By description
	FWG2680	By description
	FWG3068	By description
	FWG30611	By description
	FWG3080	By description
	FWG4068	By description
	FWG40611	By description
	FWG4080	By description

Frenchwood® Gliding Doors (1987 to Present)

Service Replacement

Service Replacement Only Parts

Stationary Panel Parts/ Stormwatch®

Stiffener - Stationary / Side (Impact Resistant)

Note:

See [Service Guide 0005407](#).

	Unit No.	Length	White	Terratone®	Sandtone	Forest Green
	FWG68	76 ⁷ / ₈	2565658	2653151	0912219	1267823
	FWG611	79 ³ / ₄	2565659	2653152	0912220	1267824
	FWG80	92 ⁷ / ₈	2565660	2653153	0912221	1267825

Bracket - Universal / Head and Sill (Impact Resistant)

	<p>Note: Applied to head and sill on stat panel.</p>	Order No.
		2579406

Screw Package - Stiffener (Impact Resistant)

	Color	Order No.
	White	9033236
	Terratone®	9033238
	Sandtone	9033237
	Forest Green	9033239

Screw Package - Frame (Impact Resistant) / Stormwatch®

Screw Package - Panel / 2-Panel (Impact Resistant)

	Color	Order No.
	White	2573698
	Terratone®/Sandtone	2653866
	Prefinished Interior White	2573702

Screw Package - Frame / 2-Panel (Impact Resistant)

	Color	Order No.
	White	2573696
	Terratone®	2653865
	Sandtone	0912816
	Forest Green	1262192
Prefinished Interior White	2573697	

Service Replacement Only Parts

Screw Package - Frame / Sidelight (Impact Resistant)		
	Color	Order No.
	White	2573701
	Terratone®	2653868
	Sandtone	0912818
	Forest Green	1262194

Screw Package - Stiffener / Outside Stop / 2-Panel (Impact Resistant)		
Note: Use Screw Package - Frame / 2 Panel as replacement.	Color	Order No.
	White	N/A
	Terratone®	N/A
	Sandtone	N/A
	Forest Green	N/A

Jambs (Impact Resistant) / Stormwatch®

Jamb - Head / Sidelight / Pine Interior (Impact Resistant)									
Unit No.	Length	Pine Interior/White Exterior		Pine Interior/Terratone® Exterior		Pine Interior/Sandtone Exterior		Pine Interior/Forest Green Exterior	
		Left	Right	Left	Right	Left	Right	Left	Right
FWG29	32	N/A		N/A		N/A		N/A	
FWG33	38	N/A		N/A		N/A		N/A	
FWG43	50	N/A		N/A		N/A		N/A	

Jamb - Head / Sidelight / Maple Interior (Impact Resistant)									
Unit No.	Length	Maple Interior/White Exterior		Maple Interior/Terratone® Exterior		Maple Interior/Sandtone Exterior		Maple Interior/Forest Green Exterior	
		Left	Right	Left	Right	Left	Right	Left	Right
FWG29	32	N/A		N/A		N/A		N/A	
FWG33	38	N/A		N/A		N/A		N/A	
FWG43	50	N/A		N/A		N/A		N/A	

Jamb - Head / Sidelight / Prefinished Interior White (Impact Resistant)				
	Unit No.	Length	Prefinished Interior White/White Exterior	
			Left	Right
	FWG29	32	N/A	
	FWG33	38	N/A	
	FWG43	50	N/A	

Frenchwood® Gliding Doors (1987 to Present)

Service Replacement

Service Replacement Only Parts

Jamb - Head / Sidelight / Optional Glazing / Prefinished Interior White						
			Prefinished White Interior/ White Exterior			
			Unit No.	Length	Left	Right
			FWG29	32	N/A	
			FWG33	38	N/A	
			FWG43	50	N/A	

Jamb - Head / 2-Panel / Pine Interior (Impact Resistant)									
Unit No.	Length	Pine Interior/ White Exterior		Pine Interior/ Terratone® Exterior		Pine Interior/ Sandtone Exterior		Pine Interior/ Forest Green Exterior	
		Left	Right	Left	Right	Left	Right	Left	Right
FWG50	59 1/4	N/A		N/A		N/A		N/A	
FWG60	71 1/4	N/A		N/A		N/A		N/A	
FWG80	95 1/4	N/A		N/A		N/A		N/A	

Jamb - Head / 2-Panel / Maple Interior (Impact Resistant)									
Unit No.	Length	Maple Interior/ White Exterior		Maple Interior/ Terratone® Exterior		Maple Interior/ Sandtone Exterior		Maple Interior/ Forest Green Exterior	
		Left	Right	Left	Right	Left	Right	Left	Right
FWG50	59 1/4	N/A		N/A		N/A		N/A	
FWG60	71 1/4	N/A		N/A		N/A		N/A	
FWG80	95 1/4	N/A		N/A		N/A		N/A	

Jamb - Head / 2-Panel / Oak Interior (Impact Resistant)									
Unit No.	Length	Oak Interior/ White Exterior		Oak Interior/ Terratone® Exterior		Oak Interior/ Sandtone Exterior		Oak Interior/ Forest Green Exterior	
		Left	Right	Left	Right	Left	Right	Left	Right
FWG50	59 1/4	N/A		N/A		N/A		N/A	
FWG60	71 1/4	N/A		N/A		N/A		N/A	
FWG80	95 1/4	N/A		N/A		N/A		N/A	

Jamb - Head / 2-Panel / Prefinished Interior White (Impact Resistant)						
			Prefinished Interior White/ White Exterior			
			Unit No.	Length	Left	Right
			FWG50	59 1/4	N/A	
			FWG60	71 1/4	N/A	
			FWG80	95 1/4	N/A	

Service Replacement Only Parts

Jamb - Head / 2-Panel / Optional Glazing / Prefinished Interior White				
Unit No.	Length	Prefinished White Interior/ White Exterior		
		Left	Right	
FWG50	59 1/4	N/A		
FWG60	71 1/4	N/A		
FWG80	95 1/4	N/A		

Jamb - Side / Stationary (Impact Resistant)									
Unit No.	Length	White		Terratone®		Sandtone		Forest Green	
		Left	Right	Left	Right	Left	Right	Left	Right
FWG68	79 13/32	N/A		N/A		N/A		N/A	
FWG611	82 9/32	N/A		N/A		N/A		N/A	
FWG80	95 13/32	N/A		N/A		N/A		N/A	

Jamb - Side / Sidelight (Impact Resistant)									
Unit No.	Length	White		Terratone®		Sandtone		Forest Green	
		Left	Right	Left	Right	Left	Right	Left	Right
FWG68	79 13/32	N/A		N/A		N/A		N/A	
FWG611	82 9/32	N/A		N/A		N/A		N/A	
FWG80	95 13/32	N/A		N/A		N/A		N/A	

Jamb - Side / Operating (Impact Resistant)									
Unit No.	Length	White		Terratone®		Sandtone		Forest Green	
		Left	Right	Left	Right	Left	Right	Left	Right
FWG68	79 13/32	N/A		N/A		N/A		N/A	
FWG611	82 9/32	N/A		N/A		N/A		N/A	
FWG80	95 13/32	N/A		N/A		N/A		N/A	

Trim Piece - Side Jamb / Stationary (Impact Resistant)						
Unit No.	Length	Pine	Maple	Oak	White	
FWG68	79 13/32	2565664	2565670	2565667	By description	
FWG611	82 9/32	2565665	2565671	2565668	By description	
FWG80	95 13/32	2565666	2565672	2565669	By description	

Frenchwood® Gliding Doors (1987 to Present)

Service Replacement

Service Replacement Only Parts

Impact Resistant Complete Sills / Stormwatch®

Complete Sill - Sidelight (Impact Resistant)

	Unit No.	Length	White		Gray	
			Left	Right	Left	Right
			FWG29	32	2500583	
FWG33	38	2500584		2640387		
FWG43	50	2500585		2640388		

Complete Sill - 2-Panel (Impact Resistant)

	Unit No.	Length	White		Gray	
			Left	Right	Left	Right
			FWG50	59 1/4	2500586	2500587
FWG60	71 1/4	2500588	2500589	2640391	2640392	
FWG80	95 1/4	2500590	2500591	2640393	2640394	

Miscellaneous Frame Parts / Stormwatch®

Parting Stop Bracket - DP Upgrade

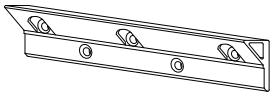
			Color	Order No.
			Gray	2573692
			White	0912717

Service Replacement Only Parts
