



LG

Life's Good

ENGLISH

ESPAÑOL

OWNER'S MANUAL & COOKING GUIDE MICROWAVE OVEN

Please read this owner's manual thoroughly before operating.

LCSC1513ST



MFL67784001

www.lg.com

Thank you for purchasing an LG microwave oven.

Please record the model number and serial number of this unit for future reference. We also suggest you record the details of your contact with LG (LG Electronics U.S.A., Inc.) concerning this unit.

Model No: _____

Serial No: _____

Dealer: _____

Dealer Phone No: _____

Staple your receipt here to prove your retail purchase.

Customer Relations
LG Electronics U.S.A., Inc.
Service Division Bldg. #3
201 James Record Rd.
Huntsville, AL 35824-0126

PRECAUTIONS TO AVOID POSSIBLE EXPOSURE TO EXCESSIVE MICROWAVE ENERGY...

- (a) Do not attempt to operate this oven with the door open since open-door operation can result in harmful exposure to microwave energy. It is important not to defeat or tamper with the safety interlocks.
- (b) Do not place any object between the oven front face and the door or allow soil or cleaner residue to accumulate on sealing surfaces.
- (c) Do not operate the oven if it is damaged. It is particularly important that the oven door closes properly and that there is no damage to the:
 - (1) Door (bent),
 - (2) Hinges and latches (broken or loosened),
 - (3) Door seals and sealing surfaces.
- (d) The oven should not be adjusted or repaired by anyone except properly qualified service personnel.

TABLE OF CONTENTS

PRECAUTIONS TO AVOID POSSIBLE EXPOSURE TO EXCESSIVE MICROWAVE ENERGY	2	Time Defrost.....	22
TABLE OF CONTENTS	3	Quick Defrost	22
SAFETY	4	Tips for Convection Cooking	23
Important Safety Instructions	4	Precautions	23
INFORMATION	6	Auto Bake	24
Location of Model Number.....	6	Auto Bake Table.....	24
Oven Specifications	6	Auto Roast	25
Electrical Requirements	6	Auto Roast Table	25
Grounding Instructions	6	Convection	26
Parts and Accessories	7	Convection Cooking Guide	27
Control Panel Features	8	Convection Baking Guide.....	28
MICROWAVE COOKING TIPS	10	Meat Roasting Table for Convection Cooking.....	29
OPERATION	14	Tips for Combination Cooking.....	30
Learn About Your Microwave Oven	14	Helpful Hints for Combination Cooking	30
Clock.....	14	Precautions	30
Child Lock	14	Combination	30
Kitchen Timer.....	14	Combination Cooking Guide	31
Custom Set	15	Heating / Reheating Guide.....	32
Custom Set Table	15	Fresh Vegetable Guide	33
Timed Cooking.....	15	MAINTENANCE	34
Add Minute.....	15	Caring for Your Microwave Oven	34
Hold Warm.....	16	Microwave Utensil Guide	35
More and Less	16	TROUBLESHOOTING	36
Multistage cooking	17	Questions and Answers	36
Microwave Power Levels	17	Before Calling for Service	38
Sensor Cooking Operation Instruction.....	18	WARRANTY	39
Sensor Reheat	18		
Sensor Reheat Table	18		
Sensor Popcorn	19		
Sensor Cook	19		
Sensor Cook Table	20		
Auto Defrost	21		
Auto Defrost Table	21		

SAFETY

IMPORTANT SAFETY INSTRUCTIONS

The safety instructions below will tell you how to use your oven and avoid harm to yourself or damage to your oven.

⚠ WARNING - To reduce the risk of burns, electric shock, fire, injury to persons, or exposure to excessive microwave energy:

• **Read all the instructions before using your oven.**

• **Do not allow children to use this oven without close supervision.**

• Read and follow the specific **PRECAUTIONS TO AVOID POSSIBLE EXPOSURE TO EXCESSIVE MICROWAVE ENERGY** found on page 2.

• **Do not use** corrosive chemicals or vapors, such as sulfide and chloride, in this appliance. This type of oven is specifically designed to heat, cook, or dry food. It is not designed for industrial or laboratory use.

• **Do not store** this appliance outdoors. Do not use this product near water - for example, near a kitchen sink, in a wet basement, near a swimming pool, or similar location.

• **Do not use** the cavity for storage purposes. Do not leave paper products, cooking utensils, or food in the cavity when not in use.

• **Clean the ventilating hood frequently.** Do not allow grease to accumulate on the hood or the filters.

• Use care when cleaning the vent hood filters. Corrosive cleaning agents, such as lye-based oven cleaners, may damage the filters.

• **Do not tamper with the built-in safety switches on the oven door.** The oven has several built-in safety switches to make sure the power is off when the door is open.

• When cooking foods under the hood, turn the fan on.

• Suitable for use above both gas and electric cooking equipment 36 inches wide or less.

• **Do not use this oven for commercial purposes.** It is made for household use only.

• **When cleaning the door and the surfaces that touch the door, use only mild, non-abrasive soaps or detergents and a sponge or soft cloth.**

• **If your oven is dropped or damaged,** have it thoroughly checked by a qualified service technician before using it again.

• **To reduce the risk of fire in the oven cavity:**

- **Do not overcook food.** Carefully attend to the microwave oven when paper, plastic or other combustible materials are placed inside the oven to facilitate cooking.

- **Do not use the cavity for storage purposes.** Do not leave paper products, cooking utensils or food in the cavity when not in use.

- Remove wire twist-ties from paper or plastic bags before placing bags in oven.

• **If materials inside the oven ignite:**

- **Keep oven door closed**

- **Turn the oven off**

- **Disconnect the power cord or shut off power at the fuse or circuit breaker panel**

• **To avoid electric shock:**

- **This appliance must be grounded.** Connect only to a properly grounded outlet. See the electrical **GROUNDING INSTRUCTIONS** on page 6.

- **Do not operate this appliance if it has a damaged cord or plug,** if it is not working properly or if it has been damaged or dropped.

- **Do not immerse the electrical cord or plug in water.**

- **Keep the cord away from heated surfaces.**

• **Take care when the door is opened to avoid injury.**

SAFETY

- **To avoid improperly cooking some foods.**
 - **Do not heat any types of baby bottles or baby food.** Uneven heating may occur and possibly cause personal injury.
 - **Do not heat small-necked containers**, such as syrup bottles.
 - **Do not deep-fat fry in your microwave oven.**
 - **Do not attempt home canning in your microwave oven.**
 - **Do not heat the following items in the microwave oven:** whole eggs in the shell, water with oil or fat, sealed containers, or closed glass jars. These items may explode.
- Do not cover or block any openings in the oven.
- Use your oven only for the operations described in this manual.
- Do not run the oven empty.
- Secure power cord in the cabinet above the oven.
- **Preserve the oven floor:**
 - **Do not heat the oven floor excessively.**
 - **Do not** allow the gray film on special microwave-cooking packages to touch the oven floor. Put the package on a microwavable dish.
 - **Do not** cook anything directly on the oven floor or turntable. Use a microwavable dish.
- Keep a browning dish at least 3/16 inch above floor. Carefully read and follow the instructions for the browning dish. If you use a browning dish incorrectly, you could damage the oven floor.
- Install or locate this appliance only in accordance with the provided installation instructions.
- This appliance should be serviced only by qualified service personnel. Contact the nearest authorized service facility for examination, repair, or adjustment.
- Liquids, such as water, coffee, or tea can be overheated beyond the boiling point without appearing to be boiling due to surface tension of the liquid. Visible bubbling or boiling when the container is removed from the microwave oven is not always present.
THIS COULD RESULT IN VERY HOT LIQUIDS SUDDENLY BOILING OVER WHEN THE CONTAINER IS DISTURBED OR A SPOON OR OTHER UTENSIL IS INSERTED INTO THE LIQUID.

To reduce the risk of injury to persons;

- Do not overheat the liquid.
- Stir the liquid both before and halfway through heating it.
- Do not use straight-sided containers with narrow necks.
- After heating, allow the container to stand in the microwave oven for a short time before removing the container.
- Use extreme care when inserting a spoon or other utensil into the container.

SAVE THESE INSTRUCTIONS

FEDERAL COMMUNICATIONS COMMISSION RADIO FREQUENCY INTERFERENCE STATEMENT (U.S.A. ONLY)

WARNING:

This equipment generates and uses ISM frequency energy and if not installed and used properly, that is in strict accordance with the manufacturer's instructions, may cause interference to radio and television reception. It has been type tested and found to comply with limits for ISM Equipment pursuant to part 18 of FCC Rules, which are designed to provide reasonable protection against such interference in a residential installation.

However, there is no guarantee that interference will not occur in a particular installation. If this equipment does cause interference to radio or television reception, which can be determined by turning the equipment off and on, the user is encouraged to try to correct the interference by one or more of the following:

- Reorient the receiving antenna of the radio or television.
- Relocate the Microwave Oven with respect to the receiver.
- Move the microwave oven away from the receiver.
- Plug the microwave oven into a different outlet so that the microwave oven and the receiver are on different branch circuits.

The manufacturer is not responsible for any radio or TV interference caused by **unauthorized modification** to this microwave oven. It is the responsibility of the user to correct such interference.

 **WARNING:** This product contains chemicals known to the State of California to cause cancer. **Wash hands after handling.**

INFORMATION

Please read this owner's manual. It will tell you how to use all the fine features of this microwave oven.

LOCATION OF MODEL NUMBER

To request service information or replacement parts, the service center will require the complete model number of your microwave oven. The model number is on the oven front as shown in the illustration below.

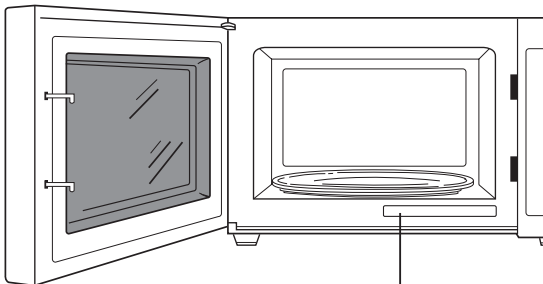

MODEL NUMBER LABEL

OVEN SPECIFICATIONS

Power Supply		120 VAC, 60 Hz
Rated Power	Microwave	1,500 W
Consumption	Convection	1,500 W
Power Output	Microwave	1,000 W
	Convection	1,500 W
Frequency		2,450 MHz
Rated Current	Microwave	13 A
	Convection	13 A
Overall Dimensions (WxHxD)		22 ⁵ / ₈ " x 14 ⁷ / ₈ " x 20" (57 x 38 x 51 cm)
Oven Cavity Dimensions (WxHxD)		15 ¹ / ₄ " x 10 ⁷ / ₈ " x 15 ¹ / ₄ " (39 x 28 x 39 cm)
Capacity of Oven Cavity		1.5 cu.ft

ELECTRICAL REQUIREMENTS

The oven is designed to operate on a Standard 120V/60Hz household outlet. Be sure the circuit is at least 15A or 20A and the microwave oven is the **only appliance on the circuit**. It is not designed for 50Hz or any circuit other than a 120 V/60 Hz circuit.

GROUNDING INSTRUCTIONS

The microwave oven must be grounded. In the event of an electrical short circuit, grounding reduces the risk of electric shock by providing an escape wire for the electric current. The microwave oven is equipped with a cord having a grounding wire with a grounding plug. The plug must be plugged into an outlet that is properly installed and grounded.

⚠ WARNING - Improper grounding can result in a risk of electric shock.

Consult a qualified electrician if you do not understand the grounding instructions or if you wonder whether the appliance is properly grounded.

Because this appliance fits under the cabinet, it has a short power-supply cord. See the separate Installation Instructions for directions on placing the cord properly.

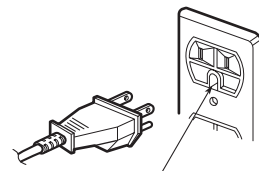

Ensure proper ground exists before use

Keep the electrical power cord dry and do not pinch or crush it in any way.

INFORMATION

PARTS AND ACCESSORIES

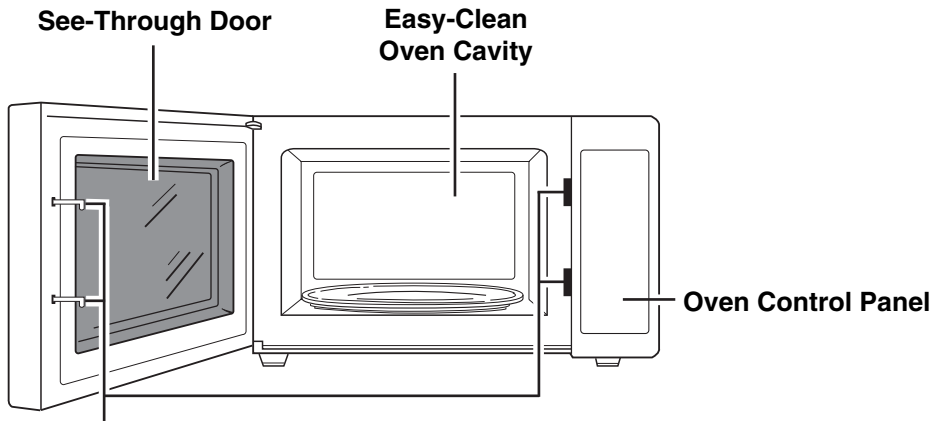

Safety Interlock System

Your oven comes with the following accessories:

- 1 Use and Care Guide
- 1 Glass Turntable
- 1 Turntable Roller Rest
- 1 Metal Rack

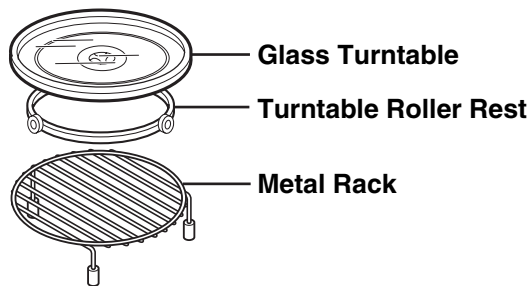

INFORMATION

CONTROL PANEL FEATURES

Your microwave oven control panel lets you select the desired cooking function quickly and easily. All you have to do is touch the necessary Command Pad. The following is a list of all the Command and Number Pads located on the control panel. **For more information on these features, see OPERATION section.**

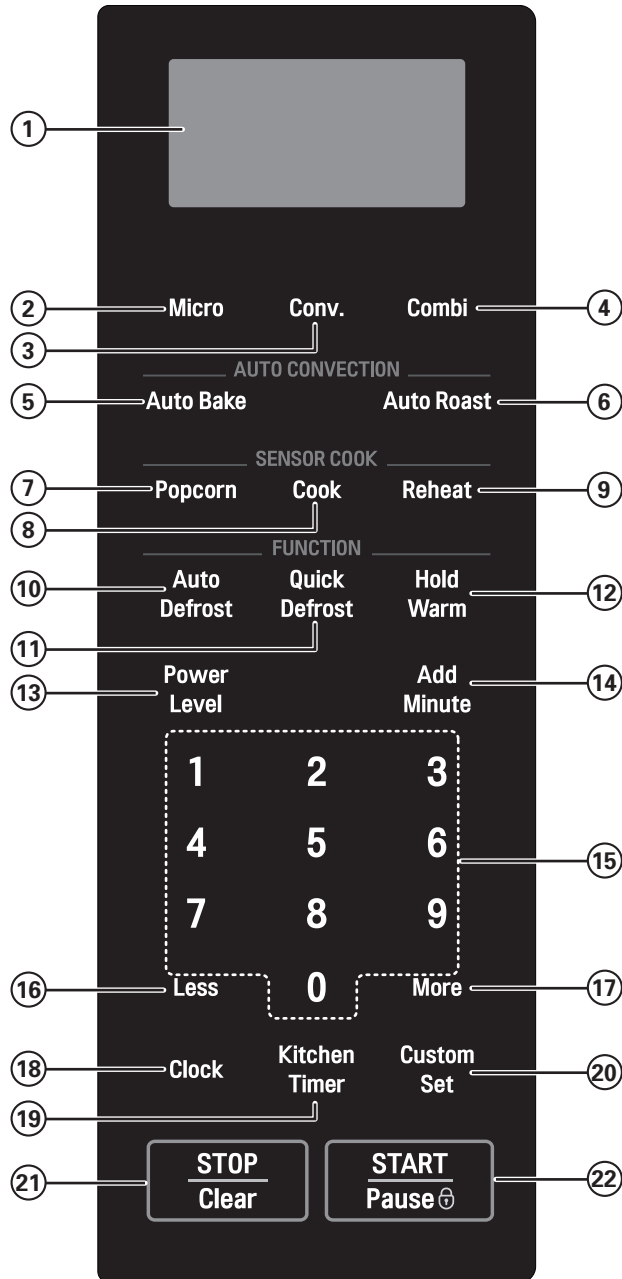

INFORMATION

- 1. Display.** The Display includes a clock and indicators to tell you time of day, cooking time settings, and cooking functions selected.
- 2. Micro.** Touch this pad when setting microwave cooking.
- 3. Conv.** Touch this pad to operate the oven for convection cooking only.
- 4. Combi.** Touch this pad to program the amount of roasting time and heat for a cooking cycle using both microwave energy and convection energy.
- 5. Auto Bake.** Touch this pad to automatically bake frozen pizza, muffins, biscuits, and frozen French fries using both microwave and convection energy alternately.
- 6. Auto Roast.** Touch this pad to automatically roast beef, chicken, turkey breasts, and pork using both microwave and convection energy alternately.
- 7. Popcorn.** Touch this pad when popping commercially packaged popcorn in your microwave oven. The oven sensor will tell the oven how long to cook depending on the amount of steam it detects from the popcorn.
- 8. Cook.** Touch this pad to cook 10 types of foods. The oven sensor will tell the oven how long to cook depending on the amount of steam coming from the food.
- 9. Reheat.** Touch this pad to reheat precooked, room-temperature, or refrigerated foods. The oven sensor will tell the oven how long to cook depending on the amount of steam coming from the food.
- 10. Auto Defrost.** Touch this pad once to automatically defrost meat, poultry, fish, or bread according to weight. Touch this pad twice to defrost most other frozen foods by time.
- 11. Quick Defrost.** Touch this pad for rapid defrosting of one pound of frozen food.
- 12. Hold Warm.** Touch this pad to keep hot, cooked foods warm in your microwave oven.
- 13. Power Level.** Touch this pad to select a cooking power level.
- 14. Add Minute.** Touch this pad to set and start cooking at 100% power.
- 15. Number.** Touch number pads to enter cooking times, cook powers, quantities, weights, or food categories.
- 16. Less.** Touch this pad to subtract ten seconds of cooking time each time it is pressed.
- 17. More.** Touch this pad to add 10 seconds of cooking time each time it is pressed.
- 18. Clock.** Touch this pad to enter the time of day.
- 19. Kitchen Timer.** Touch this pad to set the kitchen timer.
- 20. Custom Set.** Touch this pad to change the oven's default settings for volume, clock, scroll speed, units of weight, and language.
- 21. Stop/Clear.** Touch this pad to cancel a currently running program or erase a cooking cycle being programmed.
- 22. Start/Pause.** Touch this pad to start a program or to pause the oven during cooking or defrosting. Press and hold for child lock.

MICROWAVE COOKING TIPS

Amount of food

- **If you increase or decrease** the amount of food you prepare, the time it takes to cook that food will also change. For example, if you double a recipe, add a little more than half the original cooking time. Check for doneness and, if necessary, add more time in small increments.

Starting temperature of food

- **The lower the temperature** of the food being put into the microwave oven, the longer it takes to cook. Food at room temperature will be re-heated more quickly than food at refrigerator temperature.

Composition of food

- **Food with a lot of fat and sugar** will be heated faster than food containing a lot of water. Fat and sugar will also reach a higher temperature than water in the cooking process.
- **The more dense the food**, the longer it takes to heat. Very dense food like meat takes longer to heat than lighter, more porous food like sponge cakes.

Size and shape

- **Smaller pieces of food** will cook faster than larger pieces. Also, same-shaped pieces cook more evenly than different-shaped pieces.
- **With foods that have different thicknesses**, the thinner parts will cook faster than the thicker parts. Place the thinner parts of chicken wings and legs in the center of the dish.

Stirring, turning foods

- **Stirring and turning foods** spreads heat quickly to the center of the dish and avoids overcooking at the outer edges of the food.

Covering food

Cover food to:

- **Reduce** splattering
- **Shorten** cooking times
- **Keep** food moist

Releasing pressure in foods

- **Several foods** (for example: baked potatoes, sausages, egg yolks, and some fruits) are tightly covered by a skin or membrane. Steam can build up under the membrane during cooking, causing the food to burst. To relieve the pressure and to prevent bursting, pierce these foods before cooking with a fork, cocktail pick, or toothpick.

Using standing time

- **Always allow food to stand** either in or out of the oven after cooking power stops. Standing time after defrosting and cooking allows the temperature to evenly spread throughout the food, improving the cooking results. For inside oven standing time, you can program a **0** power second stage of the cooking cycle. See cooking with more than on cook cycle cooking.
- **The length of the standing time** depends on how much food you are cooking and how dense it is. Sometimes it can be as short as the time it takes you to remove the food from the oven and take it to the serving table. However, with larger, denser food item, the standing time may be as long as 10 minutes.

Arranging food

For best results, place food evenly on the plate. You can do this in several ways:

- **If you are cooking several items of the same food**, such as baked potatoes, **place** them in a ring pattern for uniform cooking.
- **When cooking foods of uneven shapes or thickness, such as chicken breasts, place** the smaller or thinner area of the food towards the center of the dish where it will be heated last.
- **Layer thin slices of meat** on top of each other.
- **When you cook or reheat whole fish, score** the skin – this prevents cracking.
- **Do not** let food or a container touch the top or sides of the oven. This will prevent possible arcing.

MICROWAVE COOKING TIPS

Using aluminum foil

Metal containers should not be used in a microwave oven. There are, however, some exceptions. If you have purchased food which is prepackaged in an aluminum foil container, refer to the instructions on the package. When using aluminum foil containers, cooking times may be longer because microwaves will only penetrate the exposed top of the food and not the bottom or the sides. If you use aluminum containers without package instructions, follow these guidelines:

- **Place the** aluminum foil container in a glass bowl and add some Water so that it covers the bottom of the container, but not more than 1/4 in. (.64 cm) deep. This ensures even heating of the container bottom.
- **Always remove** the container lid to avoid damage to the oven.
- **Use only** undamaged containers.
- **Do not use** containers taller than 3/4 in. (1.9 cm).
- **Container must be** at least half filled.
- **To avoid arcing**, there must be a minimum 1/4 in. (64 mm) between the aluminum container and the walls of the oven and also between two aluminum containers.
- **Always place** the container on the turntable.
- **Shield** parts of food that may cook quickly, such as wing tips and leg ends of poultry, with small pieces of aluminum foil.
- **Heating food** in aluminum foil containers usually takes up to double the time compared to reheating in plastic, glass, china, or paper containers. The time when food is ready will vary depending upon the type of container you use.
- **Let food stand** for 2 to 3 minutes after heating so that heat is spread evenly throughout the container.

Cooking you should not do in your microwave oven

- **Do not** do canning of foods in the oven. Closed glass jars may explode, resulting in damage to the oven.
- **Do not** use the microwave oven to sterilize objects (baby bottles, etc.). It is difficult to keep the oven at the high temperature needed for sterilization.

Removing the rack

- When popping commercially packaged popcorn, **remove the rack and drip pan from the oven**; Do not place the bag of microwave popcorn on the rack or under the rack. Leave the glass tray in place at all times.

CAUTION : Popping microwave popcorn with rack and drip pan can cause fire or damage to your microwave oven.

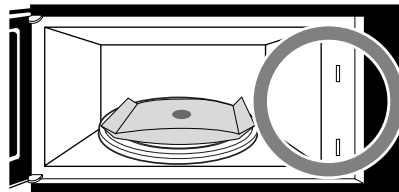
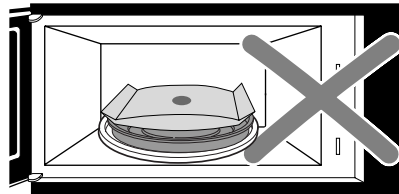
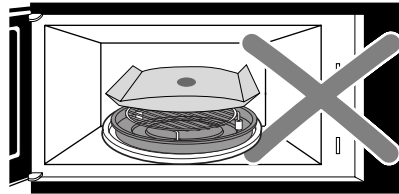

MICROWAVE COOKING TIPS

COOKING COMPARISON GUIDE

Cooking with your new oven offers a wide variety of food preparation options: microwave cooking, convection cooking, and combination cooking.

Microwave cooking uses very short, high-frequency radio waves. The movement of the microwaves through the food generates heat and cooks most foods faster than regular methods, while retaining their natural texture and moisture. Microwave cooking heats food directly, not the cookware or the interior of the oven. Reheating is easy and defrosting is particularly convenient because less time is spent in food preparation.

Convection cooking constantly circulates heated air around the food, creating even browning and sealed-in flavor by the constant motion of hot air over the food surfaces.

Combination cooking combines microwave energy with convection to cook with speed and accuracy, while browning and crisping to perfection.

You can use microwave cooking, convection cooking, or combination cooking to cook by time. Simply preset the length of cooking time desired and your oven turns off automatically.

The following guide shows at a glance the difference between microwave, convection, and combination cooking.

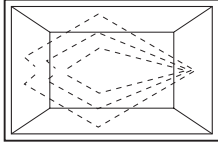
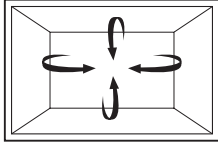
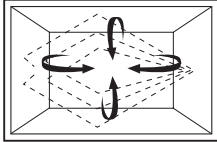
	MICROWAVE	CONVECTION	COMBINATION
COOKING METHOD	 <p>Microwave energy is distributed evenly throughout the oven for fast, thorough cooking of food.</p>	 <p>Hot air circulates around food to produce browned exteriors and sealed-in juices.</p>	 <p>Microwave energy and convection heat combine to shorten the cooking time of regular ovens, while browning and sealing in juices.</p>
HEAT SOURCE	Microwave energy.	Circulating heated air.	Microwave energy and circulating heated air.
BENEFITS	<ul style="list-style-type: none"> • Fast, high-efficiency cooking. • Oven and surroundings do not get hot. • Easy clean-up. 	<ul style="list-style-type: none"> • Aids in browning and seals in flavor. • Cooks some foods faster than regular ovens. 	<ul style="list-style-type: none"> • Shortened cooking time from microwave energy. • Browning and crisping from convection heat.
<p>Read this guide to learn the many different things your Microwave/Convection/Combination Oven can do. You will find a wide variety of cooking methods and programs designed to suit your lifestyle.</p>			

MICROWAVE COOKING TIPS

COOKWARE GUIDE

Microwave Cooking

Most heat-resistant, nonmetallic cookware is safe for use in your microwave oven.

However, to test cookware before using, follow these steps:

1. Place the empty cookware in the microwave oven.
2. Measure 1 cup (250 ml) of water in a glass measuring cup and place it in the oven beside the cookware.
3. Microwave on 100% power for 1 minute. If the dish is warm, it **should not** be used for microwave cooking.

Convection Cooking

- Metal pans are recommended for all types of baked products, but especially where browning or crusting is important.
- Dark or dull-finish metal pans are best for breads and pies because they absorb heat and produce a crisper crust.

- Shiny aluminum pans are better for cakes, cookies, or muffins because these pans reflect heat and help produce a light, tender crust.
- Glass or glass-ceramic casserole or baking dishes are best suited for egg and cheese recipes due to the cleanability of glass.

Combination Cooking

- Glass or glass-ceramic baking containers are recommended. Do not use items with metal trim as it may cause arcing (sparking) with oven wall or oven rack, damaging the cookware, the rack, or the oven.
- Heat-resistant plastic microwave cookware (safe to 450°F (230°C)) may be used, but is not recommended for foods that require crusting or all-around browning, because plastic is a poor conductor of heat.

COOKWARE	MICROWAVE	CONVECTION	COMBINATION
Heat-Resistant Glass, Ceramic-Glass	Yes	Yes	Yes
Ceramics, China	Yes (Do not use china with gold or silver trim.)	Yes	Yes
Metal Cookware	No	Yes	No
Non Heat-Resistant Glass	No	No	No
Microwave-Safe Plastic	Yes	No	Yes*
Plastic Wrap, Wax Paper	Yes	No	No
Paper Products	Yes	No	No
Straw, Wicker, and Wood	Yes	No	No

* Use only microwave cookware that is safe to 450°F (230°C)

HOW TO USE ACCESSORIES

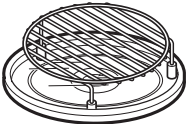
	MICROWAVE	CONVECTION	COMBINATION
 <p>Metal Rack Glass Turntable</p>	X	O	O

OPERATION

LEARN ABOUT YOUR MICROWAVE OVEN

This section discusses the concepts behind microwave cooking and introduces you to the basics you need to know to operate your microwave oven. Please read this information before using your oven.

CAUTION

To avoid risk of personal injury or property damage, do not use stoneware, metal utensils, or metal trimmed utensils in the oven.



CAUTION

To avoid risk of personal injury or property damage, do not run oven empty.

CLOCK

When the oven is first plugged into a power outlet, the "Please set clock" prompt will flash several times until the clock is set.

Example: To set the clock for 10:30.



Touch:	Display Shows:
1. 	
2. Clock	ENTER TIME OF DAY
3. 1 0 3 0	10:30 TOUCH START
4. 	10:30

NOTE: Please unplug and plug in to reset the clock.

CHILD LOCK

Use this safety feature to lock the control panel when you are cleaning the oven, or so that children cannot use the oven unsupervised.

Example: To set Child Lock.

Touch:	Display Shows:
1. 	Time of day
2. 	Touch and hold until "LOCKED" appears (approximately 4 seconds). LOCKED
Example: To cancel CHILD LOCK.	
1. 	Touch and hold until "LOCKED" disappears (approximately 4 seconds). Time of day

KITCHEN TIMER

Your microwave oven can be used as a kitchen timer. You can set up to 99 minutes, 99 seconds.

Example: To set 3 minutes.

Touch:	Display Shows:
1. 	Time of day
2. Kitchen Timer	ENTER TIME IN MIN AND SEC
3. 3 0 0	3:00 TOUCH TIMER
4. Kitchen Timer	Timer and time counting down

NOTE: To cancel, press Kitchen Timer.

OPERATION

CUSTOM SET

Example: To change defrost weight mode (from lbs. to kg).

Touch:	Display Shows:
1. 	Time of day
2. Custom Set	SOUND TOUCH 1 CLOCK TOUCH 2 SCROLL SPEED TOUCH 3 LBS F / KG C TOUCH 4 DEMO TOUCH 5 LANGUAGE TOUCH 6
3. 4	LBS F TOUCH 1 KG C TOUCH 2
4. 2	KG C

You can change the default values for beep sound, clock, scroll speed, units, demo, and language. See the following table for more information.

CUSTOM SET TABLE

Function	Pad	Option
Sound	1	Mute, low, medium, loud
Clock	2	On or off
Scroll Speed	3	Slow, normal, or fast
Units	4	Lbs, °F or Kg, °C
Demo	5	On or off
Language	6	English or Spanish

TIMED COOKING

This feature lets you program a specific cook time and power. For best results, there are 10 power level settings in addition to HIGH (100%) power. Refer to the “Microwave Power Levels Table” on page 14 for more information.

NOTE: If you do not select a power level, the oven will automatically cook at 100% power.

Example: Timed Cooking for 2 minutes.

Touch:	Display Shows:
1. Micro	ENTER COOKING TIME
2. 2 0 0	2:00 TOUCH START OR POWER
3. Power Level	2:00 ENTER POWER LEVEL 1 - 10
4. 8	2:00 P - 80 TOUCH START
5. 	COOK 80 Time counting down

ADD MINUTE

A time-saving pad, this simplified control lets you quickly set and start microwave cooking at 100% power without the need to touch START.

Example: To cook for 2 minutes.

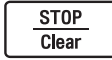

Touch:	Display Shows:
1. 	Time of day
2. Add Minute Twice	Time counting down and POWER 100

NOTE: If you touch ADD MINUTE, it will add 1 minute up to 99 minutes 59 seconds. This feature is also ideal for a 1-minute quick-start.

OPERATION

HOLD WARM

You can safely keep hot, cooked food warm in your microwave oven for up to 99 minutes. You can use HOLD WARM by itself or to automatically follow a cooking cycle.

Example: Hold Warm	
Touch:	Display Shows:
1. 	Time of day
2. Hold Warm	TOUCH START
3. 	WARM

At the end of the Warm Hold, "END" will be displayed and four tones will sound.

NOTE: To end, hit STOP/Clear.

To make HOLD WARM automatically follow another cycle:

- **While you are entering cooking instructions, touch HOLD WARM** before touching START.
- **When the last cooking cycle is over, you will hear two tones.** "Warm" will come on while the oven continues to run.
- You can set HOLD WARM to follow AUTO DEFROST, CONV., or multi-stage cooking.

NOTES:

- **HOLD WARM** operates for up to 99 minutes.
- **Opening** the oven door cancels HOLD WARM. Close the door and touch HOLD WARM, then touch START if additional HOLD WARM time is desired.
- **Food cooked covered** should be covered during HOLD WARM.
- **Pastry items** (pies, turnovers, etc.) should be uncovered during HOLD WARM.
- **Complete meals** kept warm on a dinner plate should be covered during HOLD WARM.
- **Do not use** more than one complete HOLD WARM cycle. The quality of some foods will suffer with extended time.

MORE and LESS

More

The MORE and LESS functions of this oven adjust the cooking cycle's cook time while the microwave is running.

Less

More adds 10 seconds to the cook time; **Less** subtracts 10 seconds.

- Use MORE or LESS when cooking time is counting down in the display. MORE and LESS cannot be set when "SENSING" is displayed.
- MORE and LESS do not adjust cook time for the DEFROST and HOLD WARM cooking cycles.
- Press **More** or **Less** pads during active cooking cycle.
- For convection cooking, MORE or LESS are used as temperature selection pads.

OPERATION

MULTISTAGE COOKING

For best results, some recipes call for different cook powers during different stages of a cook cycle. You can program your oven to switch from one power level to another for up to 2 stages.

Example: 2-stage cook cycle.	
Touch:	Display Shows:
1. Micro	ENTER COOKING TIME
2. 3 0 0 to set a 3-minute cook time for the first stage.	3:00 TOUCH START OR POWER
3. Power Level	3:00 ENTER POWER LEVEL 1-10
4. 8 to set an 80% cook power for the first stage.	3:00 P - 80 TOUCH START
5. Micro	ENTER COOKING TIME
6. 7 0 0 to set a 7-minute cook time for the second stage.	7:00 TOUCH START OR POWER
7. Power Level	7:00 ENTER POWER LEVEL 1-10
8. 5 to set a 50% cook power for the second stage.	7:00 P - 50 TOUCH START
9. 	COOK 80 Time counting down
10. When the first stage is over, you will hear two short tones as the oven begins the second cook stage.	

MICROWAVE POWER LEVELS

Your microwave oven has 10 cook power levels to let you cook or heat a wide variety of foods. Refer to the table below for suggestions:

Microwave Power Level Table

Power Level	Use
10 (High)	<ul style="list-style-type: none"> • Boiling water. • Making candy. • Cooking poultry pieces, fish, and vegetables. • Cooking tender cuts of meat. • Whole poultry.
9	<ul style="list-style-type: none"> • Reheating rice, pasta, and vegetables.
8	<ul style="list-style-type: none"> • Reheating prepared foods quickly. • Reheating sandwiches.
7	<ul style="list-style-type: none"> • Cooking egg, milk, and cheese dishes. • Cooking cakes, breads. • Melting chocolate.
6	<ul style="list-style-type: none"> • Cooking veal. • Cooking whole fish. • Cooking puddings and custard.
5	<ul style="list-style-type: none"> • Cooking ham, whole poultry, and lamb. • Cooking rib roast, sirloin tip.
4	<ul style="list-style-type: none"> • Thawing meat, poultry, and seafood.
3	<ul style="list-style-type: none"> • Cooking less tender cuts of meat. • Cooking pork chops, roast.
2	<ul style="list-style-type: none"> • Taking chill out of fruit. • Softening butter.
1	<ul style="list-style-type: none"> • Keeping casseroles and main dishes warm. • Cream cheese.
0	<ul style="list-style-type: none"> • Standing time.

OPERATION

SENSOR COOKING OPERATION INSTRUCTION

A sensor detects steam from the food and automatically adjusts cook time for the best cooking results. It's easy and convenient—the oven will guide you, step-by-step, to cook or reheat foods. The Sensor Menu, with many popular food choices, is preprogrammed to cook or reheat food perfectly every time.

For more information about Sensor Cooking Programs, see the sensor reheat and cook tables on pages 15 and 17. These tables provide specific instructions for cooking and heating a variety of foods.

- The Sensor Cooking system works by detecting a buildup of vapor.
- Make sure the door remains closed.
- Once the vapor is detected, two beeps will sound.
- Opening the door or touching the STOP/Clear before the vapor is detected will abort the process. The oven will stop.
- Before using Sensor Cooking, make sure the glass turntable is dry, to ensure the best results.

Categories:

Sensor Reheat
Sensor Popcorn
Sensor Cook

SENSOR REHEAT

This feature allows you to reheat precooked roomtemperature or refrigerated foods without selecting cooking times and power levels. This feature has 3 categories: Dinner Plate, Soup/Sauce, and Casserole. See the following table for more information.

Example : To reheat casserole.	
Touch:	Display Shows:
1. 	Time of day
2. Reheat	SELECT MENU 1-3
3. 3	CASSEROLE ↓ SENSING

The oven will reheat food automatically by sensor system.

SENSOR REHEAT TABLE

	Food	Serving Amount and Recommendations
1	Dinner Plate	Serving size is about 8 to 16 oz (225 to 450 g). Place food to be heated on a dinner plate or similar dish. Cover with plastic wrap and vent*.
2	Soup/Sauce	Serving size is 1 to 4 cups (250 ml to 1 l). Place food to be heated in a casserole dish. Cover with plastic wrap and vent*.
3	Casserole	Serving size is 1 to 4 cups (250 ml to 1 l). Place food to be heated in a casserole dish. Cover with plastic wrap and vent*.

* Fold back one corner of the plastic wrap to vent excess steam.

OPERATION

SENSOR POPCORN

SENSOR POPCORN lets you pop commercially packaged microwave popcorn (1.75 or 3.5 oz. [50 or 99 g]).

For best results:

- Use fresh popcorn.
- Place only one bag of prepackaged microwave popcorn on the center of turntable.

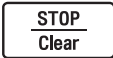
Example : To pop 3.5 oz. (100 g).	
Touch:	Display Shows:
1. 	Time of day
2. Popcorn	POPCORN ↓ SENSING

NOTES:

- Do not attempt to reheat or cook any unpopped kernels.
- Do not use popcorn-popping devices in the microwave oven with this feature.
- UNDER NO CIRCUMSTANCES should you use a popper that concentrates the microwave energy.

SENSOR COOK

SENSOR COOK allows you to cook most of your favorite foods without having to select cooking times and power levels. The oven automatically determines required cooking times for each food item. SENSOR COOK has 10 food categories (see the table on the following page).

Example: To cook a frozen entrée.	
Touch:	Display Shows:
1. 	Time of day
2. Cook	SELECT MENU 0-9
3. 3	FROZEN ENTREE ↓ SENSING

The oven will cook food automatically by sensor system.

OPERATION

SENSOR COOK TABLE

	Food	Serving Amount and Recommendations
1	Potato	Serving size is 1 to 4 medium sized potatoes, about 8 to 10 oz. (225 to 280 g) each. Pierce each potato several times with a fork and place around the edge of the oven tray, at least 1 in. (2.5 cm) apart.
2	Fresh Vegetable	Serving size is 1 to 4 cups (250 ml to 1 l). Place moist vegetables in a microwavable container. Add 2 to 4 tablespoons (30 to 60 ml) water. Cover with plastic wrap and vent*. Most vegetables need stirring and 2 to 3 minutes standing time after cooking.
3	Frozen Vegetable	Serving size is 1 to 4 cups (250 ml to 1 l). Remove from package and place vegetables in a microwavable container. Add 2 to 4 tablespoons (30 to 60 ml) water. Cover with plastic wrap and vent*. Most vegetables need stirring and 2 to 3 minutes standing time after cooking.
4	Frozen Entrée	Entrée size is 10 to 20 oz. (285 to 560 g). Remove from outer package. Loosen cover on three sides. If entrée is not in a microwave-safe container, place it on a plate, cover with plastic wrap, and vent*. Most entrées need 2 to 3 minutes standing time after cooking.
5	Rice	Follow package instructions for ingredient amounts. Place rice and liquid (water, chicken, or vegetable stock) in a microwave-safe container, cover with casserole lid or plastic wrap and vent*. Most rice needs 2 to 3 minutes standing time after cooking.
6	Casserole	Serving size is 1 to 4 cups (250 ml to 1 l). Combine the ingredients per the recipe in a 1- to 2-quart (1- to 2-l) casserole dish. Cover with plastic wrap and vent*. After cooking is complete, allow 3 minutes standing time.
7	Ground Meat	Serving size is 4 to 32 oz. (1/4 to 2 lbs.) (115 to 900 g). Crumble meat into a microwave-safe container. Season and cover with plastic wrap. Vent cover for well-done meat. Cover dish for medium cooked meat (such as meat to be used in another dish and cooked further).
8	Fish/Seafood	Serving size is 4 to 32 oz. (1/4 to 2 lbs.) (115 to 900 g). Place the food around the sides of a microwave-safe container. Season and add 1/4 to 1/2 cup (60 to 125 ml) liquid (wine, water, salsa, etc.) if desired. Cover with plastic wrap and vent*.
9	Scrambled Eggs	Serving size is 2 to 5 eggs. Break eggs into a 4-cup (1 l) measuring cup or 1-quart (1 l) casserole dish. Add 1 tablespoon (15 ml) milk or water per egg and beat. Cover with plastic wrap and vent*. When cooking is complete, remove from oven, stir, and allow 1 to 2 minutes standing time.
0	Frozen Pizza	Serving size is 1 or 2 pieces. Use only frozen pizza intended for microwave use. Do not cover. Follow package directions.

* Fold back one corner of the plastic wrap to vent excess steam.

OPERATION



AUTO DEFROST

Four defrost choices are preset in the oven. The defrost feature provides you with the best defrosting method for frozen foods, because the oven automatically sets the defrosting times for each food item according to the weight you enter. For added convenience, the AUTO DEFROST includes a built-in tone mechanism that reminds you to check, turn over, separate, or rearrange the food during the defrost cycle. Four different defrosting options are provided.

1. **MEAT**
2. **POULTRY**
3. **FISH**
4. **BREAD**

After touching the AUTO DEFROST pad once, select the food category by touching number pad 1 (Meat), 2 (Poultry), 3 (Fish), or 4 (Bread). Available weight ranges for Meat, Poultry, and Fish are 0.1 to 6.0 lbs. (.05 to 2.7 kg). The available weight range for Bread is 0.1 to 1.0 lb. (.05 to 2.7 kg).

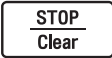
Example: To defrost 1.2 lbs. (0.5 kg) of meat.

Touch:	Display Shows:
1. 	Time of day
2. Auto Defrost	MEAT TOUCH 1 POULTRY TOUCH 2 FISH TOUCH 3 BREAD TOUCH 4
3. 1	ENTER WEIGHT
4. 1 and 2 to enter the weight	1.2 LBS TOUCH START
5. 	MEAT Time counting down

NOTE:

When you touch the START/PAUSE pad, the display changes to defrost time countdown. The oven will beep during the DEFROST cycle. At this time, open the door and turn, separate, or rearrange the food. Remove any portions that have thawed. Return frozen portions to the oven and touch START/PAUSE to resume the defrost cycle. **The oven will not CLEAR during the BEEP unless the door is opened.**

For best results:

- Remove fish, shellfish, meat, and poultry from its original closed paper or plastic package (wrapper). Otherwise, the wrap will hold steam and juice close to the foods, which can cause the outer surface of the foods to cook.
- Form the meat into the shape of a doughnut before freezing. When defrosting, scrape off thawed meat when the beep sounds and continue defrosting.
- Place foods in a shallow glass baking dish or on a microwave roasting rack to catch drippings.
- Foods should still be somewhat icy in the center when removed from the oven.

AUTO DEFROST TABLE

Category	Food
MEAT 0.1 to 6.0 lbs. (.05 to 2.7 kg)	BEEF Ground beef, round steak, cubes for stew, tenderloin steak, pot roast, rib roast, rump roast, chuck roast, hamburger patty LAMB Chops (1-in. [2.5-cm] thick), rolled roast PORK Chops (1/2-in. [1-cm] thick), hot dogs, spareribs, country-style ribs, rolled roast, sausage VEAL Cutlets (1 lb. (0.5 kg), 1/2-in. [1-cm] thick).
POULTRY 0.1 to 6.0 lbs. (.05 to 2.7 kg)	POULTRY Whole (under 4 lbs. [1.8 kg]), pieces, breasts (boneless) CORNISH HENS Whole TURKEY Breast (under 6 lbs. [2.7 kg])
FISH 0.1 to 6.0 lbs. (.05 to 2.7 kg)	FISH Fillets, whole steaks SHELLFISH Crab meat, lobster tails, shrimp, scallops
BREAD 0.1 to 1.0 lbs. (.05 to 2.7 kg)	MUFFINS ROLL CAKE

OPERATION

TIME DEFROST

Example: To defrost for 3 minutes.

Touch:	Display Shows:
1. Auto Defrost twice	ENTER DEFROST TIME
2. 3 0 0	3:00 TOUCH START
3. 	MEAT Time counting down

At the end of the defrost time, tones sound and oven turns off.

QUICK DEFROST

Example: 1 lb. (0.5 kg) of meat.

Touch:	Display Shows:
1. Quick Defrost	MEAT TOUCH 1 POULTRY TOUCH 2 FISH TOUCH 3
2. 1	TOUCH START
3. 	QUICK Time counting down

NOTE:

- The oven beeps approximately midway through a defrost cycle to remind you to check the food. Pause the oven by opening the door. Once food has been checked or rearranged, close door and press START/PAUSE to resume the defrost cycle.

OPERATION

TIPS FOR CONVECTION COOKING

This section gives you cooking instructions and procedures for operating each convection function. Please read these instructions carefully.

Convection cooking circulates hot air through the oven cavity with a fan. The constantly moving air surrounds the food to heat the outer portion quickly, creating even browning and sealed-in flavor by the constant motion of hot air over the food surfaces. Your oven uses convection cooking whenever you use the Convection button. **DO NOT USE THE OVEN WITHOUT THE TURNTABLE IN PLACE.**

1. **Always use the metal rack** on the turntable when convection cooking.
2. **Do not cover** the turntable or metal rack with aluminum foil. It interferes with the flow of air that cooks the food.
3. **Round pizza pans** are excellent cooking utensils for many convection-only items. Choose pans that do not have extended handles.
4. **Use convection cooking** for items like soufflés, breads, cookies, angel food cakes, pizza, and for some meat and fish cooking.
5. **You do not need to use** any special techniques to adapt your favorite oven recipes to convection cooking; however, in general you need to lower the oven temperature by 25°F (14°C) from the recommended temperature mentioned in package instructions when cooking packaged food in convection mode.
6. **When baking** cakes, cookies, breads, rolls, or other baked foods, most recipes call for preheating. Preheat the empty oven just as you do a regular oven. You can start heavier, dense foods such as meats, casseroles, and poultry without preheating.
7. **All heatproof** cookware or metal utensils can be used in convection cooking.
8. **As in conventional cooking**, the distance of the food from the heat source affects cooking results. Refer to the tables in this Use and Care Guide.
9. **Use metal utensils** only for convection cooking. Never use for microwave or combination cooking since arcing and damage to the oven may occur.
10. **After preheating**, if you do not open the door, the oven will automatically hold at the preheated temperature for 30 minutes.

PRECAUTIONS

- The oven cavity, door, turntable, roller rest, metal tray, metal rack, and cooking utensils will become very hot.

USE THICK OVEN GLOVES when removing the food, cooking utensils, metal rack, metal tray, and turntable from the oven after convection cooking.



- Do not use lightweight plastic containers, plastic wraps, or paper products during any convection cycle.

OPERATION

AUTO BAKE

To automatically bake frozen pizza, muffins, biscuits and frozen French fries using both microwave and convection energy alternately:

Example: To bake 6 muffins.

Touch:	Display Shows:
1. 	Time of day
2. Auto Bake	FROZEN PIZZA TOUCH 1 MUFFINS TOUCH 2 BISCUIT/DINNER ROLL/B. STICK TOUCH 3 FROZEN FRENCH FRIES TOUCH 4
3. 2 Touch appropriate digit touch pad.	USE RACK AND 6 CUP MUFFIN PAN NO FOOD IN OVEN TOUCH START
<ul style="list-style-type: none"> Muffins and biscuits require a preheat cycle and should be placed on the rack after the signal sounds. Frozen pizza MUST be placed directly on the convection cooking rack. DO NOT use a metal pizza tray or aluminum foil. Muffins, biscuits, and dinner rolls can use metal muffin tins if glass pan is not available. Breadsticks and frozen French fries can be placed on a small shallow metal pan, such as a tray, if a glass pan is not available. 	
4. 	PREHEAT
<ul style="list-style-type: none"> If additional information is needed, oven will prompt in display. 	
At the end of the cooking time, tones sound, END displays, and the oven turns off.	

AUTO BAKE TABLE



Food	Serving Amount and Recommendations
1. FROZEN PIZZA	For best results, a pizza pan is not required. Use a 12-inch thin-crust frozen pizza. If baking a rising-crust pizza, add an additional 10 to 20 minutes' baking time on convection cook at 450°F (230°C). Place the frozen pizza directly on the short rack.
2. MUFFINS	Use 1 package of a muffin mix. Place the short rack on the turntable. After PREHEAT , use 6-cup muffin pan; place pan on rack.
3. BISCUIT/ DINNER ROLL/ BREAD STICK	For best results, bake one pan of biscuits, dinner rolls, or breadsticks at a time. After PREHEAT , place the biscuits 1–2 in. (2.5–5 cm) apart on a greased pizza pan or cookie sheet on the short rack. Cool on the rack for 10 minutes after cooking.
4. FROZEN FRENCH FRIES	Use frozen, prepared French fries. Do not overlap or layer potatoes. For crispier potatoes, use MORE to add additional cooking time. Spread the french fries on a pizza pan or cookie sheet. Place the pan on the short rack. After cooking, remove the pan from the oven. Weight range: 4 to 16 oz. (115 to 450 g).

OPERATION

AUTO ROAST

Auto roast will automatically roast beef, whole chicken, turkey breasts, and pork using both microwave and convection energy alternately.

Example: To roast a whole chicken (3 lbs. [1.5 kg]).

Touch:	Display Shows:
1. 	Time of day
2. Auto Roast	BEEF TOUCH 1 WHOLE CHICKEN TOUCH 2 TURKEY BREASTS TOUCH 3 PORK TOUCH 4
3. 2	USE RACK ENTER 2.5 - 6 LBS
4. 3 0	3.0 LBS TOUCH START
5. 	ROAST Time counting down

• If additional information is needed, the oven will prompt in the display.

At the end of the cooking time, tones sound, **END** displays, and the oven turns off.

AUTO ROAST TABLE

Food	Serving Amount and Recommendations
1. BEEF	Weigh roast and pat dry with paper towels. Place a microwave-safe/heatproof plate on turntable to catch drippings. Place roast on short rack. After cooking, loosely tent roast beef with aluminum foil and let stand for 5 to 10 minutes. Weight range: 2 to 4 lbs. (1 to 2 kg)
2. WHOLE CHICKEN	Weigh whole chicken. Remove giblets and neck and discard. Thoroughly wash inside and outside of chicken with cold water. Pat chicken dry with paper towels. Secure the legs with kitchen twine. Brush outside of chicken with melted butter or margarine. Place a microwavesafe/heatproof plate on turntable to catch drippings. Place chicken breast side up on short rack. After cooking, loosely tent roast chicken with aluminum foil and let stand for 10 minutes. Weight range: 2.5 to 6 lbs. (1 to 3 kg)
3. TURKEY BREASTS	Weigh turkey breast and pat dry with paper towels. Brush turkey breast with melted butter. Place a microwave-safe/heatproof plate on turntable to catch drippings. Place turkey breast on short rack. After cooking, loosely tent roast turkey with aluminum foil and let stand for 5 to 10 minutes. Weight range: 3 to 6 lbs. (1 to 3 kg)
4. PORK	Weigh roast and pat dry with paper towels. Place a microwave-safe/heatproof plate on turntable to catch drippings. Place roast on short rack. After cooking, loosely tent roast with aluminum foil and let stand for 5 to 10 minutes. Weight range: 2 to 4 lbs. (1 to 2 kg)



OPERATION

CONVECTION

During convection cooking, a heating element is used to raise the temperature of the air inside the oven. Convection cooking temperature ranges from 225°F (107°C) to 450°F (230°C); and 100°F (38°C) may be programmed.

It is best to preheat the oven when convection cooking.



Example: To set the convection cooking at 325°F (160°C) for 45 minutes with preheating.

Touch:	Display Shows:
1. 	Time of day
2. Conv.	350 F TOUCH MORE OR LESS FOR TEMP SET OR START OR ENTER COOKING TIME
3. Less	325 F TOUCH START FOR PREHEAT OR ENTER COOKING TIME
4. 	PREHEAT 325 F
NOTES:	
<ul style="list-style-type: none"> • After preheating, display scrolls "PLACE FOOD ON RACK" with sound. • Use thick oven gloves; oven interior will be hot. • Open the door, place food on the rack, and close the door. Display scrolls "ENTER COOKING TIME." 	
5. 4 5 0 0	45:00 TOUCH START
6. 	CV 325 F Time counting down

NOTES:

- When the oven reaches the set preheat temperature, five tones will sound and the oven will automatically hold that temperature for 30 minutes.
- The oven temperature drops very quickly when the door is opened; however, this should not prevent food from being fully cooked during normal cooking time.

Example: To set the convection cooking at 375°F (190°C) for 30 minutes without preheating.

Touch:	Display Shows:
1. 	Time of day
2. Conv.	350 F TOUCH MORE OR LESS FOR TEMP SET OR START OR ENTER COOKING TIME
3. More	375 F TOUCH START FOR PREHEAT OR ENTER COOKING TIME
4. 3 0 0 0	30:00 TOUCH START
5. 	CV 375 F Time counting down

NOTES:

- The temperature range has 10 steps from 225°F (107°C) to 450°F (230°C) including 100°F (38°C) (dough rising).
- Use MORE/LESS to increase/decrease the temperature by 25°F (14°C) after touching the CONVECTION button. (The default temperature is 350°F [180°C].)

OPERATION

CONVECTION COOKING GUIDE

1. Always use the metal rack when convection baking.
2. Aluminum pans conduct heat quickly. For most convection baking, light, shiny finishes give the best results because they prevent overbrowning in the time it takes to cook the center areas. Pans with dull (satin-finish) bottoms are recommended for cake pans and pie pans for best bottom browning.
3. Dark or nonshiny finishes, glass, and pyroceram absorb heat which may result in dry, crisp crusts.
4. Preheating the oven is recommended when baking foods by convection.
5. To prevent uneven heating and save energy, open the oven door to check food as little as possible.

FOOD		Oven Temp.	Time, Min.	Comments
Breads	Biscuits	400°F (200°C)	10 to 12	Canned refrigerated biscuits take 2 to 4 minutes less time.
	Corn Bread	400°F (200°C)	15 to 20	Remove from pans immediately and cool slightly on wire rack.
	Muffins	400°F (200°C)	18 to 24	
	Popovers	350°F (180°C)	30 to 40	Pierce each popover with a fork after removing from oven to allow steam to escape.
	Nut Bread or Fruit Bread	350°F (180°C)	55 to 65	Interiors will be moist and tender.
	Yeast Bread	375°F (190°C)	18 to 25	Lightly grease baking sheet.
Plain or Sweet Rolls	350°F (180°C)	13 to 16		
Cakes	Angel Food	350°F (180°C)	40 to 50	Invert and cool in pan.
	Cheesecake	350°F (180°C)	60 to 65	After cooking, turn oven off and let cheesecake stand in oven 30 minutes with door ajar.
	Coffee Cake	350°F (180°C)	25 to 30	Interior will be moist and tender.
	Cupcakes	350°F (180°C)	15 to 20	
	Fruitcake (loaf)	350°F (180°C)	80 to 90	
	Gingerbread	350°F (180°C)	35 to 40	
	Butter Cakes, Cake Mixes	350°F (180°C)	30 to 40	Grease and flour pan.
	Fluted Tube Cake	350°F (180°C)	40 to 50	
Pound Cake	350°F (180°C)	60 to 70	Cool in pan 10 minutes before inverting on wire rack.	
Cookies	Bar	350°F (180°C)	35 to 45	Follow package instructions if using a mix.
	Drop or Sliced	375°F (190°C)	10 to 14	Follow package instructions if using a mix.

NOTES:

- The oven temperature indicated in the table above is recommended over the package instruction temperature.
- The baking times in the table above are only guidelines for your reference. You need to adjust the baking time according to the food condition or your preference.

OPERATION

CONVECTION BAKING TABLE

FOOD		Oven Temp.	Time, Min.	Comments
Fruits, Other Desserts	Baked Apples or Pears	350°F (180°C)	30 to 30	Bake in cookware with shallow sides.
	Bread Pudding	300°F (150°C)	35 to 40	Pudding is done when knife inserted near center comes out clean.
	Cream Puffs	400°F (200°C)	30 to 35	Puncture puffs twice with toothpick to release steam after 25 minutes of baking time.
	Custard (individual)	350°F (180°C)	45 to 50	Set cups in baking dish. Pour boiling water around cups to a depth of 1 in. (2.5 cm).
	Meringue Shells	300°F (150°C)	30 to 35	When done, turn oven off and let shells stand in oven 1 hour to dry.
Pies, Pastries	Frozen Meringue-Topped Two-Crust	375°F (190°C)	40 to 45	Follow package directions for preparation.
	Quiche	325°F (160°C)	13 to 16	Follow package directions for preparation.
	Pastry Shell	400°F (200°C)	50 to 55	Follow package directions for preparation.
		350°F (180°C)	30 to 35	Let stand 5 minutes before cutting.
		400°F (200°C)	10 to 16	Pierce pastry with fork to prevent shrinkage.
Casseroles	Meat, chicken, seafood combinations	350°F (180°C)	20 to 40	Cook times vary with casserole size and ingredients.
	Pasta	350°F (180°C)	25 to 45	Cook times vary with casserole size and ingredients.
	Potatoes, Scalloped Vegetable	350°F (180°C) 350°F (180°C)	55 to 60 25 to 35	Let stand 5 minutes before serving. Cook times vary with casserole size and ingredients.
Convenience Foods	Frozen Bread Dough	350°F (180°C)	30 to 35	Follow package directions for preparation.
	Frozen Entrée	350°F (180°C)	50 to 60	Follow package directions for preparation.
	Frozen Pizza Rolls, Egg Rolls	400°F (200°C)	8 to 10	Follow package directions for preparation.
	Pizza	425°F (220°C)	15 to 25	Follow package directions for preparation.
	Slice-and-Bake Cookies	375°F (190°C)	13 to 15	Let stand a few minutes before removing from pan to cool.
Main Dishes	Meat Loaf	325°F (160°C)	55 to 60	Let stand 5 minutes after cooking.
	Oven-Baked Stew	325°F (160°C)	80 to 90	Brown meat before combining with liquid and vegetables.
	Swiss Steak	350°F (180°C)	60 to 70	Let stand 2 minutes after cooking.
	Stuffed Peppers	350°F (180°C)	40 to 45	Use green, red, or yellow peppers.
Vegetables	Acorn Squash Halves	375°F (190°C)	55 to 60	Pierce skin several places. Add 1/4 cup (60 ml) water to dish. Turn squash halves cut side up after 30 minutes of cook time and cover.
	Baked Potatoes Twice-Baked Potatoes	425°F (220°C) 400°F (200°C)	50 to 60 25 to 30	Pierce skin with a fork before baking. Pierce skin with fork before baking.

NOTES:

- The oven temperatures indicated in the table above are recommended over the package instruction temperature.
- The baking times in the table above are only guidelines for your reference. You need to adjust the baking time according to the food condition or your preference.

OPERATION

MEAT ROASTING TABLE FOR CONVECTION COOKING

MEATS		Oven Temp.	Time, Min./lb.
Beef	Rib (2 to 4 lbs. [1 to 2 kg])		
	Rare	325°F (160°C)	21 to 26
	Medium	325°F (160°C)	26 to 31
	Well	325°F (160°C)	31 to 36
	Boneless Rib, Top Sirloin		
	Rare	325°F (160°C)	25 to 30
	Medium	325°F (160°C)	30 to 35
	Well	325°F (160°C)	35 to 40
	Beef Tenderloin		
	Rare	325°F (160°C)	12 to 16
Medium	325°F (160°C)	16 to 20	
Pot Roast (2½ to 3 lbs. [1 to 1.5 kg])			
Chuck, Rump	325°F (160°C)	45 to 50	
Ham	Canned (3-lb. [1.5 kg] fully cooked)	325°F (160°C)	20 to 25
	Butt (5-lb. [2.3 kg] fully cooked)	325°F (160°C)	20 to 25
	Shank (5-lb. [2.3 kg] fully cooked)	325°F (160°C)	17 to 20
Lamb	Bone-In (2 to 4 lbs. [1 to 2 kg])		
	Medium	325°F (160°C)	21 to 26
	Well	325°F (160°C)	26 to 31
	Boneless (2 to 4 lbs. [1 to 2 kg])		
	Medium	325°F (160°C)	25 to 30
Well	325°F (160°C)	29 to 34	
Pork	Bone-In (2 to 4 lbs. [1 to 2 kg])	325°F (160°C)	26 to 30
	Boneless (2 to 4 lbs. [1 to 2 kg])	325°F (160°C)	32 to 36
	Pork Chops (1/2- to 1-inch [1- to 2.5-cm] thick)		
	2 chops	325°F (160°C)	12 to 15
	4 chops	325°F (160°C)	15 to 18
	6 chops	325°F (160°C)	18 to 25
Poultry	Whole Chicken (2½ to 3½ lbs. [1 to 2 kg])	375°F (190°C)	25 to 35
	Chicken Pieces (2½ to 3½ lbs. [1 to 2 kg])	350°F (180°C)	13 to 16
	Cornish Hens		
	Unstuffed (1 to 1½ lbs. [0.5 to 0.7 kg])	375°F (190°C)	10 to 15
	Stuffed (1 to 1½ lbs. [0.5 to 0.7 kg])	375°F (190°C)	15 to 20
	Duckling (4 to 5 lbs. [2 to 2.3 kg])	375°F (190°C)	19 to 21
Turkey Breast (4 to 6 lbs. [2 to 3 kg])	325°F (160°C)	21 to 25	
Seafood	Fish, Whole (3 to 5 lbs. [1.5 to 2.3 kg])	400°F (200°C)	10 to 15
	Lobster Tails (6 to 8 oz. [170 to 225 g] each)	350°F (180°C)	12 to 17

NOTE:

- The roasting times in the table above are only guidelines for your reference. You need to adjust the roasting time according to the food condition or your preference.

OPERATION

TIPS FOR COMBINATION COOKING

This section gives you instructions to operate each combination cooking function. Please read these instructions carefully. Sometimes combination microwave-convection cooking is suggested to get the best cooking results since it shortens the cooking time for foods that normally need a long time to cook. This cooking process also leaves meats juicy on the inside and crispy on the outside. In combination cooking, the convection heat and microwave energy alternate automatically. Your oven has two preprogrammed settings that make it easy to use combination cooking.

HELPFUL HINTS FOR COMBINATION COOKING

- 1. Meats** may be roasted directly on the metal rack or in a shallow roasting pan placed on the rack. When using the metal rack, please check your cooking guide for information on proper use.
- 2. Less tender** cuts of beef can be roasted and tenderized using oven cooking bags.
- 3. When baking**, check for doneness after cooking time is up. If not completely done, let stand in oven for a few minutes to complete cooking.



PRECAUTIONS

- All cookware used for combination cooking must be BOTH microwave-safe and ovenproof.
- During combination baking, some baking cookware may cause arcing when it comes in contact with the oven walls or metal accessory racks. Arcing is a discharge of electricity that occurs when microwaves come in contact with metal.
 - If arcing occurs when using the metal rack, place a heatproof dish between the pan and the metal rack.
 - If arcing occurs with other baking cookware, do not use them for combination cooking.

COMBINATION

	Oven Temperature	Microwave Power
Combination Roast	350°F (180°C)	40%

Example: To roast with combination cooking for 45 minutes.

Touch:	Display Shows:
1. 	Time of day
2. Combi	350 F TOUCH MORE OR LESS FOR TEMP SET OR ENTER COOKING TIME
3. 4 5 0 0	45:00 TOUCH START
4. 	⌘ 350 F Time counting down

NOTES:

- The temperature can be adjusted; however, the microwave power cannot.
- By using MORE/LESS in combination cooking, you can adjust the temperature by 25°F (14°C) after step 3. (The default temperature is 350°F [180°C].)

OPERATION

COMBINATION COOKING GUIDE

MEATS		Oven Temp.	Time, Min./lb.
Beef	Rib (2 to 4 lbs. [1 to 2 kg])		
	Rare	300°F (150°C)	11 to 14
	Medium	300°F (150°C)	14 to 17
	Well	300°F (150°C)	17 to 20
	Boneless Rib, Top Sirloin		
	Rare	300°F (150°C)	11 to 14
	Medium	300°F (150°C)	14 to 17
	Well	300°F (150°C)	17 to 20
	Beef Tenderloin		
	Rare	300°F (150°C)	14 to 17
Medium	300°F (150°C)	17 to 20	
Chuck, Rump, or Pot Roast (2 ¹ / ₂ to 3 lbs. [1 to 1.5 kg]) (Use cooking bag for best results.) Turn over after half of the cooking time.	275°F (140°C)	30 to 40	
Ham	Canned (3-lb. [1.5 kg] fully cooked)	300°F (150°C)	15 to 18
	Butt (5-lb. [2.3 kg] fully cooked)	300°F (150°C)	15 to 18
	Shank (5-lb. [2.3 kg] fully cooked)	300°F (150°C)	15 to 18
	Turn over after half of the cooking time.		
Lamb	Bone-In (2 to 4 lbs. [1 to 2 kg])		
	Medium	300°F (150°C)	13 to 18
	Well	300°F (150°C)	18 to 23
	Boneless (2 to 4 lbs. [1 to 2 kg])		
	Medium	300°F (150°C)	14 to 19
	Well	300°F (150°C)	19 to 24
Turn over after half of the cooking time.			
Pork	Bone-In (2 to 4 lbs. [1 to 2 kg])	300°F (150°C)	13 to 16
	Boneless (2 to 4 lbs. [1 to 2 kg])	300°F (150°C)	18 to 23
	Pork Chops (3/4- to 1-in. [2- to 2.5-cm] thick)		
	2 chops	350°F (180°C)	10 to 13
	4 chops	350°F (180°C)	13 to 16
	6 chops	350°F (180°C)	16 to 19
	Turn over after half of the cooking time.		
Poultry	Whole Chicken (2 ¹ / ₂ to 6 lbs. [1 to 3 kg])	375°F (190°C)	18 to 20
	Chicken Pieces (2 ¹ / ₂ to 6 lbs. [1 to 3 kg])	375°F (190°C)	15 to 18
	Cornish Hens		
	Unstuffed	375°F (190°C)	18 to 25
	Stuffed	375°F (190°C)	23 to 30
	Duckling	375°F (190°C)	15 to 18
	Turkey Breast (4 to 6 lbs. [2 to 3 kg])	300°F (150°C)	11 to 15
Seafood	Turn breast side up after half of the cooking time.		
	Fish Fillets (1-lb. [0.5-kg])	350°F (180°C)	7 to 10
	Lobster Tails (6 to 8 oz. [170 to 225 g] each)	350°F (180°C)	10 to 15
	Shrimp (1 to 2 lbs. [0.5 to 1 kg])	350°F (180°C)	8 to 13
	Scallops (1 to 2 lbs. [0.5 to 1 kg])	350°F (180°C)	8 to 13

NOTE:

• The roasting times in the table above are only guidelines for your reference. You need to adjust the time according to the food condition or your preference.

OPERATION

HEATING / REHEATING GUIDE

To heat or reheat successfully in a microwave oven, it is important to follow several guidelines. Measure the amount of food in order to determine the time needed to reheat. Arrange the food in a circular pattern for best results. Room temperature food will heat faster than refrigerated food. Canned foods should be taken out of the can and placed in a microwave-safe container. The food will heat more evenly if covered with a microwave-safe lid or vented plastic wrap*. Remove cover carefully to prevent steam burns. Use the following table as a guide for reheating cooked food.

ITEMS	Cook Time (at High)	Special Instructions
Sliced Meat 3 slices (1/4-inch thick [.63 cm])	1-2 minutes	Place sliced meat on microwavable plate. Cover with plastic wrap and vent*. Note: Gravy or sauce helps to keep meat juicy.
Chicken Pieces 1 breast 1 leg and thigh	2-3 1/2 minutes 1 1/2-3 minutes	Place chicken pieces on microwavable plate. Cover with plastic wrap and vent*.
Fish Fillet (6–8 oz. [170-225 g])	2-4 minutes	Place fish on microwavable plate. Cover with plastic wrap and vent*.
Lasagna 1 serving (10 1/2 oz. [300 g])	4-6 minutes	Place lasagna on microwavable plate. Cover with plastic wrap and vent*.
Casserole 1 cup (250 ml) 4 cups (1l)	1-3 1/2 minutes 5-8 minutes	COOK covered in microwavable casserole. Stir once halfway through cooking.
Casserole – Cream or Cheese 1 cup (250 ml) 4 cups (1l)	1 1/2-3 minutes 3 1/2-5 1/2 minutes	COOK covered in microwavable casserole. Stir once halfway through cooking.
Sloppy Joe or Barbecued Beef 1 sandwich (1/2 cup [125 ml] meat filling) without bun	1-2 1/2 minutes	Reheat filling and bun separately. Cook filling covered in microwavable casserole. Stir once. Heat bun as directed in table below.
Mashed Potatoes 1 cup (250 ml) 4 cups (1l)	1-3 minutes 5-8 minutes	COOK covered in microwavable casserole. Stir once halfway through cooking.
Baked Beans 1 cup (250 ml)	1 1/2-3 minutes	COOK covered in microwavable casserole. Stir once halfway through cooking.
Ravioli or Pasta in Sauce 1 cup (250 ml) 4 cups (1l)	2 1/2-4 minutes 7 1/2-11 minutes	COOK covered in microwavable casserole. Stir once halfway through cooking.
Rice 1 cup (250 ml) 4 cups (1l)	1 1/2-3 1/2 minutes 4-6 1/2 minutes	COOK covered in microwavable casserole. Stir once halfway through cooking.
Sandwich Roll or Bun 1 roll	15-30 seconds	Wrap in paper towel and place on glass microwavable rack.
Vegetables 1 cup (250 ml) 4 cups (1l)	1 1/2-2 1/2 minutes 4-6 minutes	COOK covered in microwavable casserole. Stir once halfway through cooking.
Soup 1 serving (8 oz. (250 ml))	1 1/2-2 1/2 minutes	COOK covered in microwavable casserole. Stir once halfway through cooking.

* Fold back one corner of the plastic wrap to vent excess steam.

OPERATION

FRESH VEGETABLE GUIDE

VEGETABLE	AMOUNT	Cook Time at High	Instructions	Standing Time
Artichokes (8 oz. (225 g) each)	2 medium 4 medium	5-8 min. 10-13 min.	Trim. Add 2 tsp (10 ml) water and 2 tsp (10 ml) juice. Cover.	2-3 min.
Asparagus, Fresh, Spears	1 lb. (0.5 kg)	3-6 min.	Add 1/2 cup (125 ml) water. Cover.	2-3 min.
Beans, Green and Wax	1 lb. (0.5 kg)	7-11 min.	Add 1/2 cup (125 ml) water in 1 1/2-qt. (1.5-l) casserole. Stir halfway through cooking.	2-3 min.
Beets, Fresh	1 lb. (0.5 kg)	12-16 min.	Add 1/2 cup (125 ml) water in 1 1/2-qt. (1.5-l) covered casserole. Rearrange halfway through.	2-3 min.
Broccoli, Fresh, Spears	1 lb. (0.5 kg)	4-8 min.	Place broccoli in a baking dish. Add 1/2 (125 ml) cup water.	2-3 min.
Cabbage, Fresh, Chopped	1 lb. (0.5 kg)	4-7 min.	Add 1/2 cup (125 ml) water in 1 1/2-qt. (1.5-l) covered casserole. Stir halfway through cooking.	2-3 min.
Carrots, Fresh, Sliced	2 cups (0.5 l)	2-4 min.	Add 1/4 cup (60 ml) water in 1-qt. (1-l) covered casserole. Stir halfway through cooking.	2-3 min.
Cauliflower, Fresh, Whole	1 lb. (0.5 kg)	7-11 min.	Trim. Add 1/4 cup (60 ml) water in 1-qt. (1-l) covered casserole. Stir halfway through cooking.	2-3 min.
Flowerettes, Fresh Celery, Fresh, Sliced	2 cups (0.5 l) 4 cups (1 l)	2 1/2-4 1/2 min. 6-8 min.	Slice. Add 1/2 cup (125 ml) water in 1 1/2-qt. (1.5-l) covered casserole. Stir halfway through cooking.	2-3 min.
Corn, Fresh	2 ears	5-9 min.	Husk. Add 2 tbsp (30 ml) water in 1 1/2-qt. (1.5-l) baking dish. Cover.	2-3 min.
Mushrooms, Fresh, Sliced	1/2 lb. (225 g)	2-3 1/2 min.	Place mushrooms in 1 1/2-qt. (1.5-l) covered casserole. Stir halfway through cooking.	2-3 min.
Parsnips, Fresh, Sliced	1 lb. (0.5 kg)	4-8 min.	Add 1/2 cup (125 ml) water in 1 1/2-qt. (1.5-l) covered casserole. Stir halfway through cooking.	2-3 min.
Peas, Green, Fresh	4 cups (1 l)	7-10 min.	Add 1/2 cup (125 ml) water in 1 1/2-qt. (1.5-l) covered casserole. Stir halfway through cooking.	2-3 min.
Sweet Potatoes Whole Baking (6-8 oz. (170-225 g) each)	2 medium 4 medium	5-10 min. 7-13 min.	Pierce potatoes several times with fork. Place on 2 paper towels. Turn over halfway through cooking.	2-3 min. 2-3 min.
White Potatoes, Whole Baking (6-8 oz. (170-225 g) each)	2 potatoes 4 potatoes	5-8 min. 10-14 min.	Pierce potatoes several times with fork. Place on 2 paper towels. Turn over halfway through cooking.	2-3 min. 2-3 min.
Spinach, Fresh, Leaf	1 lb. (0.5 kg)	4-7 min.	Add 1/2 cup (125 ml) water in 2-qt. (2-l) covered casserole.	2-3 min.
Squash, Acorn or Butternut, Fresh	1 medium	6-8 min.	Cut squash in half. Remove seeds. Place in 8-in. x 8-in. (20-cm x 20-cm) baking dish. Cover.	2-3 min.
Zucchini, Fresh, Sliced	1 lb. (0.5 kg)	4 1/2-7 1/2 min.	Add 1/2 cup (125 ml) water in 1 1/2-qt. (1.5-l) covered casserole. Stir halfway through cooking.	2-3 min.
Zucchini, Fresh, Whole	1 lb. (0.5 kg)	6-9 min.	Pierce. Place on 2 paper towels. Turn over and rearrange halfway through cooking.	2-3 min.

MAINTENANCE

CARING FOR YOUR MICROWAVE OVEN

To make sure your microwave oven looks good and works well for a long time, you should maintain it properly. For proper care, please follow these instructions carefully.

For interior surfaces: Wash often with warm, sudsy water and a sponge or soft cloth. Use only mild, nonabrasive soaps or a mild detergent. **Be sure to keep the areas clean where the door and oven frame touch when closed.** Wipe well with clean cloth. Over time, stains can occur on the surfaces as the result of food particles spattering during cooking. This is normal.

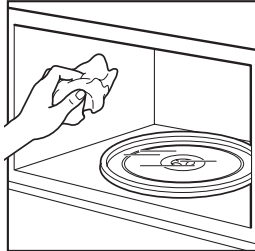

For stubborn soil, boil a cup of water in the oven for 2 to 3 minutes. Steam will soften the soil. To get rid of odors inside the oven, boil a cup of water with some lemon juice or vinegar in it.

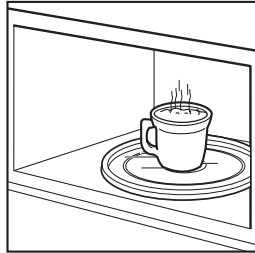

For exterior surfaces and control panel: Use a soft cloth with spray glass cleaner. Apply the spray glass cleaner to the soft cloth; do not spray directly on the oven.

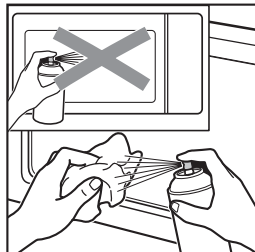

NOTE: Abrasive cleansers, steel wool pads, gritty wash cloths, some paper towels, etc., can damage the control panel and the interior and exterior oven surfaces.

To clean glass tray and rotating ring, wash in mild, sudsy water; for heavily soiled areas use a mild cleanser and scouring sponge. The glass tray and rotating ring are dishwasher safe.

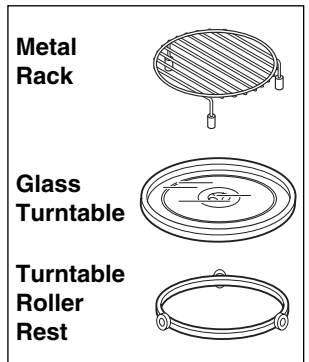

MAINTENANCE

MICROWAVE UTENSIL GUIDE

USE	DO NOT USE
<p>OVENPROOF GLASS (treated for high intensity heat): utility dishes, loaf dishes, pie plates, cake plates, liquid measuring cups, casseroles and bowls without metallic trim.</p> <p>CHINA: bowls, cups, serving plates, and platters without metallic trim.</p> <p>PLASTIC: Plastic wrap (as a cover)-- lay the plastic wrap loosely over the dish and press it to the sides. Vent plastic wrap by turning back one edge slightly to allow excess steam to escape. The dish should be deep enough so that the plastic wrap will not touch the food. As the food heats it may melt the plastic wrap wherever the wrap touches the food. Use plastic dishes, cups, semi-rigid freezer containers and plastic bags only for short cooking time. Use these with care because the plastic may soften from the heat of the food.</p> <p>PAPER: Paper towels, waxed paper, paper napkins, and paper plates with no metallic trim or design. Look for the manufacturer's label for use in the microwave oven.</p> <p>NOTE: Do not use recycled paper products in the microwave oven. They sometimes contain impurities that cause arcing and sparking.</p> <p>NEVER use paper products in the convection oven.</p>	<p>METAL UTENSILS: Metal shields the food from microwave energy and produces uneven cooking. Also avoid metal skewers, thermometers, or foil trays. Metal utensils can cause arcing, which can damage your microwave oven.</p> <p>METAL DECORATION: Metal-trimmed or metal-banded dinnerware, casserole dishes, etc. The metal trim interferes with normal cooking and may damage the oven.</p> <p>ALUMINUM FOIL: Avoid large sheets of aluminum foil because they hinder cooking and may cause harmful arcing. Use small pieces of foil to shield poultry legs and wings. Keep ALL aluminum foil at least 1 inch from the side walls and door of the oven.</p> <p>WOOD: Wooden bowls and boards will dry out and may split or crack when you use them in the microwave oven. Baskets react in the same way.</p> <p>TIGHTLY COVERED UTENSILS: Be sure to leave openings for steam to escape from covered utensils. Pierce plastic pouches of vegetables or other food items before cooking. Tightly closed pouches could explode.</p> <p>BROWN PAPER: Avoid using brown paper bags. They absorb too much heat and could burn.</p> <p>FLAWED OR CHIPPED UTENSILS: Any utensil that is cracked, flawed, or chipped may break in the oven.</p> <p>METAL TWIST TIES: Remove metal twist ties from plastic or paper bags. They become hot and could cause a fire.</p>

TROUBLESHOOTING

Questions and Answers

Operation

Question	Answer
Why is the oven light not on during cooking?	Bulb may be burned out, requiring replacement.
Is there a clock display? Is there no clock display?	Set a cook time. Touch START. Check the house circuit safety device.
Why does steam come out of the air exhaust vent?	Steam is normally produced during cooking. The microwave oven has been designed to vent this steam.
Will the microwave oven be damaged if it operates empty?	Yes. Never operate the oven empty or without the glass turntable.
Does microwave energy pass through the viewing screen in the door?	No. The metal screen bounces the energy back to the oven cavity. The holes (or ports) allow only light to pass through. They do not let microwave energy pass through.
Why does a tone sound when a pad on the control panel is touched?	The tone tells you that the setting has been entered.
Can the microwave oven be damaged if food is cooked for too long?	Like any other cooking appliance, it is possible to overcook food to the point that the food creates smoke and even possibly fire and damage to the inside of the oven. It is always best to be near the oven while you are cooking.
When the oven is plugged into the wall outlet for the first time, it doesn't work properly. What is wrong?	The microcomputer controlling your oven may temporarily become scrambled and fail to function as programmed when you plug it in for the first time or when power resumes after a power interruption. Unplug the oven from the 120-volt household outlet and then plug it back in to reset the microcomputer by resetting the clock.
Why is there light reflection around the outer case?	This light is from the oven light which is located between the oven cavity and the outer wall of the oven.
What are the various sounds heard when the microwave oven is operating?	The clicking sound is caused by a mechanical switch turning the microwave oven's magnetron ON and OFF. The heavy hum and clunk is from the change in power the magnetron draws as it is turned ON and OFF by a mechanical switch. The change in blower speed is from the change in line voltage caused by the magnetron being turned ON and OFF.

TROUBLESHOOTING

Questions and Answers (continued)

Food

Question	Answer
What is wrong when baked foods have a hard, dry, brown spot?	A hard, dry, brown spot indicates overcooking. Shorten the cooking or reheating time.
Why do eggs sometimes pop?	When baking, frying, or poaching eggs, the yolk may pop due to steam buildup inside the yolk membrane. To prevent this, simply pierce the yolk with a wooden toothpick before cooking. CAUTION: Never microwave eggs in the shell.
Why are scrambled eggs sometimes a little dry after cooking?	Eggs will dry out when they are overcooked, even if the same recipe is used each time. The cooking time may need to be varied for one of these reasons: <ul style="list-style-type: none"> • Eggs vary in size. • Eggs are at room temperature one time and at refrigerator temperature another time. • Eggs continue cooking during standing time.
Why do baked apples sometimes burst during cooking?	The peel has not been removed from the top half of each apple to allow for expansion of the interior of the apple during cooking. As in conventional cooking methods, the interior of the apple expands during the cooking process.
Why do baked potatoes sometimes burn during cooking?	If the cooking time is too long, fire could result. At the end of the recommended cooking time, potatoes should be slightly firm. CAUTION: Do not overcook.
Why is a standing time recommended after microwave cooking time is over?	Standing time allows foods to continue cooking evenly for a few minutes after the actual microwave oven cooking cycle ends. The amount of standing time depends upon the density of the foods.
Why is additional time required for cooking food stored in the refrigerator?	As in conventional cooking, the initial temperature of food affects total cooking time. You need more time to cook food taken out of a refrigerator than for food at room temperature.

TROUBLESHOOTING

BEFORE CALLING FOR SERVICE

Check the following list to be sure a service call is really necessary. A quick reference of this manual as well as reviewing additional information on items to check may prevent an unneeded service call.

If nothing on the oven operates:

- check for a blown circuit fuse or a tripped main circuit breaker.
- check if oven is properly connected to electric circuit in house.
- check that controls are set properly.

If the oven interior light does not work:

- the light bulb is loose or defective.

If oven will not cook:

- check that control panel was programmed correctly.
- check that door is firmly closed.
- check that Start was pressed.
- check that probe was inserted correctly into receptacle.
- check that timer wasn't started instead of a cook function.

If oven takes longer than normal to cook or cooks too rapidly:

- be sure the Power Level is programmed properly.

If the time of day clock does not always keep correct time:

- check that the power cord is fully inserted into the outlet receptacle.
- be sure the oven is the only appliance on the electrical circuit.

If food cooks unevenly:

- be sure food is evenly shaped.
- be sure food is completely defrosted before cooking.
- check placement of aluminum foil strips used to prevent overcooking.

If food is undercooked:

- check recipe to be sure all directions (amount, time, and power levels) were correctly followed.
- be sure microwave oven is on a separate circuit.
- be sure food is completely defrosted before cooking.

If food is overcooked:

- check recipe to be sure all directions (amount, power level, time, size of dish) were followed.

If arcing (sparks) occur:

- be sure microwavable dishes were used.
- be sure wire twist ties weren't used.
- be sure oven wasn't operated when empty.
- make sure metal rack (if used) is properly installed on 4 supports.

If the Display shows a time counting down but the oven is not cooking:

- check that door is firmly closed.
- check that timer wasn't started instead of a cooking function.



LG MICROWAVE OVEN LIMITED WARRANTY – USA Model LCSC1513ST

LG Electronics, Inc. will repair or replace your product, at LG’s option, if it proves to be defective in material or workmanship under normal use, during the warranty period set forth below, effective from the date of original consumer purchase of the product. This warranty is good only to the original purchaser of the product and effective only when used in the United States, including U.S. Territories.

<p><u>WARRANTY PERIOD:</u></p> <p>LABOR: One Year from the Date of Purchase*.</p> <p>PARTS (except as listed below): One Year from the Date of Purchase*.</p> <p>MAGNETRON: Ten Years from the Date of Purchase*.</p> <p>Replacement Units and Repair Parts are warranted for the remaining portion of the original unit’s warranty period.</p> <p>* Retain your Sales Receipt to prove the date of purchase. A copy of your Sales Receipt must be submitted at the time warranty service is provided.</p>	<p><u>HOW SERVICE IS HANDLED:</u></p> <p>Please call 1-800-243-0000 and choose the appropriate option. (Phones are answered 24 hours a day, 365 days per year.) Please have the product type (Microwave) and your ZIP code ready.</p> <p>Or visit our website at: http://us.lgservice.com</p>
---	---

THIS WARRANTY IS IN LIEU OF ANY OTHER WARRANTY, EXPRESS OR IMPLIED, INCLUDING WITHOUT LIMITATION, ANY WARRANTY OF MERCHANTABILITY OR FITNESS FOR A PARTICULAR PURPOSE. TO THE EXTENT ANY IMPLIED WARRANTY IS REQUIRED BY LAW, IT IS LIMITED IN DURATION TO THE EXPRESS WARRANTY PERIOD ABOVE. LG WILL NOT BE LIABLE FOR ANY INCIDENTAL, CONSEQUENTIAL, INDIRECT, SPECIAL, OR PUNITIVE DAMAGES OF ANY NATURE, INCLUDING WITHOUT LIMITATION, LOST REVENUES OR PROFITS, OR ANY OTHER DAMAGE WHETHER BASED IN CONTRACT, TORT, OR OTHERWISE. Some states do not allow the exclusion or limitation of incidental or consequential damages or limitations on how long an implied warranty lasts, so the above exclusion or limitation may not apply to you. This warranty gives you specific legal rights and you may also have other rights that vary from state to state.

THIS LIMITED WARRANTY DOES NOT APPLY TO:

- Service trips to your home to deliver, pick up, and/or install the product, instruct, or replace house fuses or correct wiring, or correction of unauthorized repairs.
- Damages or operating problems that result from misuse, abuse, operation outside environmental specifications or contrary to the requirements of precautions in the Operating Guide, accident, vermin, fire, flood, improper installation, acts of God, unauthorized modification or alteration, incorrect electrical current or voltage, or commercial use, or use for other than intended purpose.

The cost of repair or replacement under these excluded circumstances shall be borne by the consumer.

CUSTOMER INTERACTIVE CENTER NUMBERS

To obtain Customer Assistance, Product Information, or Dealer or Authorized Service Center location:	Call 1-800-243-0000 (24 hours a day, 365 days per year) and select the appropriate option from the menu. Or visit our website at: http://us.lgservice.com
---	--

TO CONTACT LG ELECTRONICS BY MAIL:

LG Customer Interactive Center
P. O. Box 240007
201 James Record Road
Huntsville, Alabama 35824
ATTN: CIC

MEMO



LG Customer Information Center

1-800-243-0000 USA, Consumer User

1-888-865-3026 USA, Commercial User

Register your product Online!

www.lg.com

Printed in Korea