

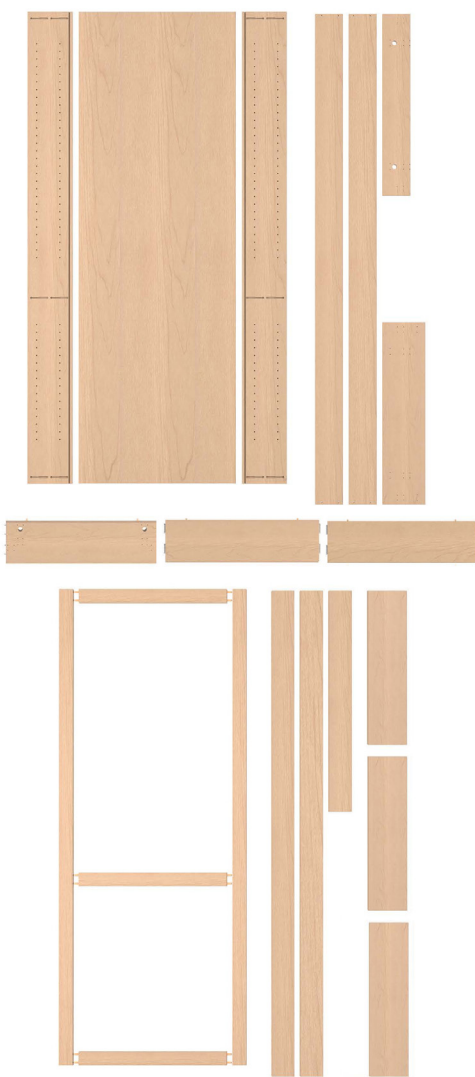

MURPHY DOOR™
CREATIVE DOOR SOLUTIONS

FLUSH MOUNT UNASSEMBLED KIT ASSEMBLY INSTRUCTIONS



Looking for an installation video?

Scan this code to go directly to our door assembly support page and view the installation video.

<https://www.themurphydoor.com/assembly-video/>



(8) 7x50mm Confirmat Screws



(6) #6 x 1.5in Square Head Pocket Screws



(12) Dowel Pins



(18) 8mm Wood Dowels

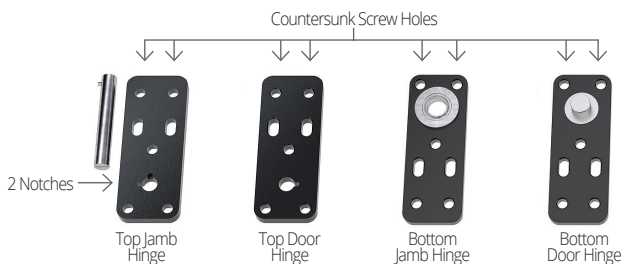

BOOKCASE

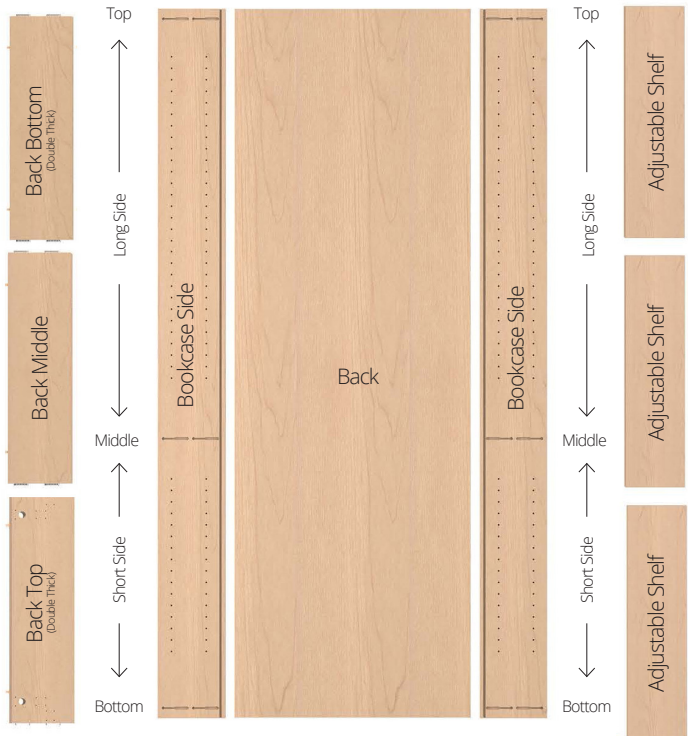

JAMB

FACE FRAME

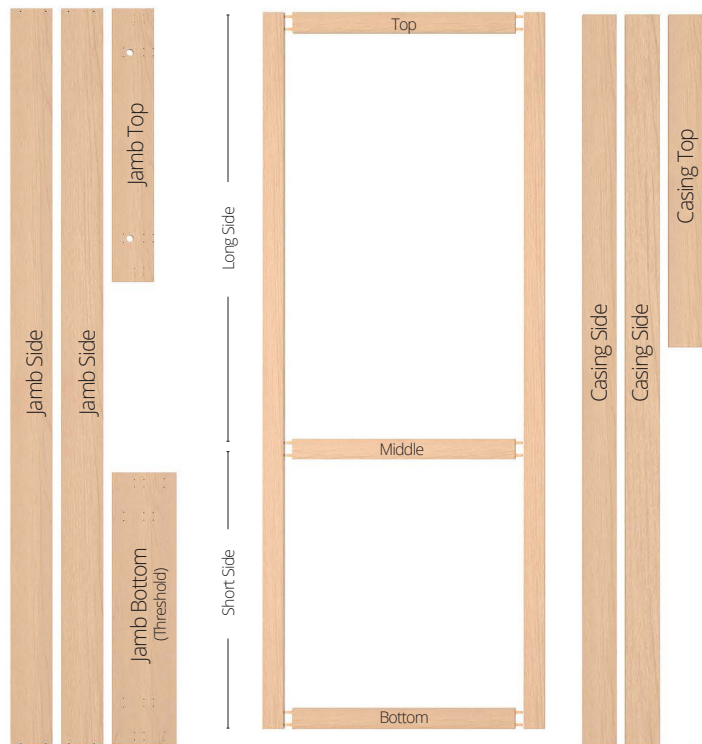

NOTE: French Doors will include a longer upper jamb and threshold as well as a center trim/casing piece.

PLEASE READ INSTRUCTIONS FULLY BEFORE YOU BEGIN ASSEMBLY

1 Assemble Face Frame

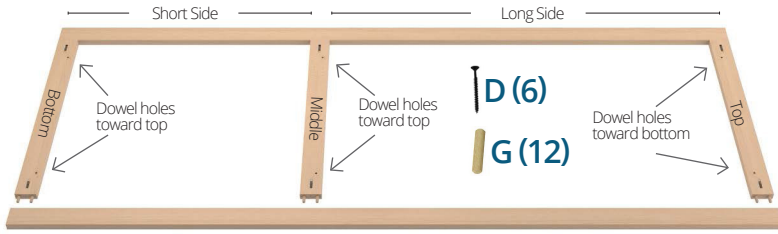

NOTE: Please verify dowel orientation to ensure that they are not installed upside down.

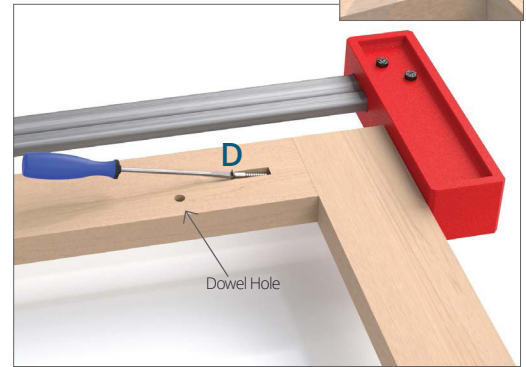
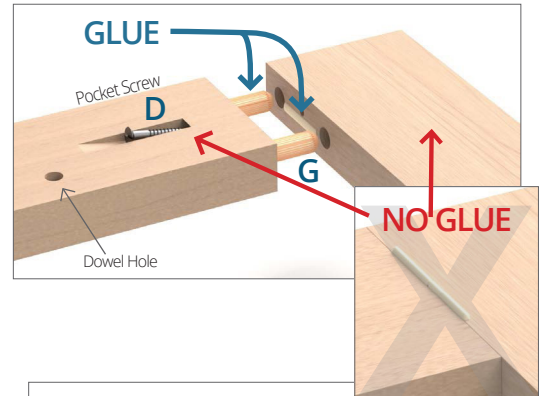

2 Assemble Bookcase

NOTE: The top and bottom bookshelf pieces are double thick and the middle piece is just a standard single thickness.

The dowel holes where you will attach the face frame are on the front side of each piece. Make sure that they are all facing outward towards the front of the door when assembling.

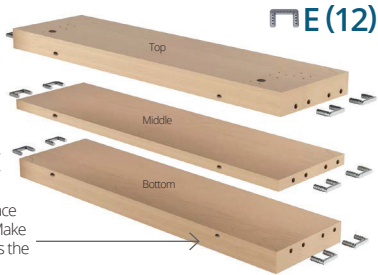

(Enlarged View)



Top shelf will have pre-drilled hole where you will drop the hinge pin through. The bottom shelf does not.

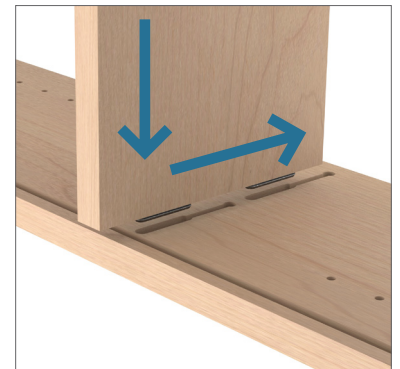
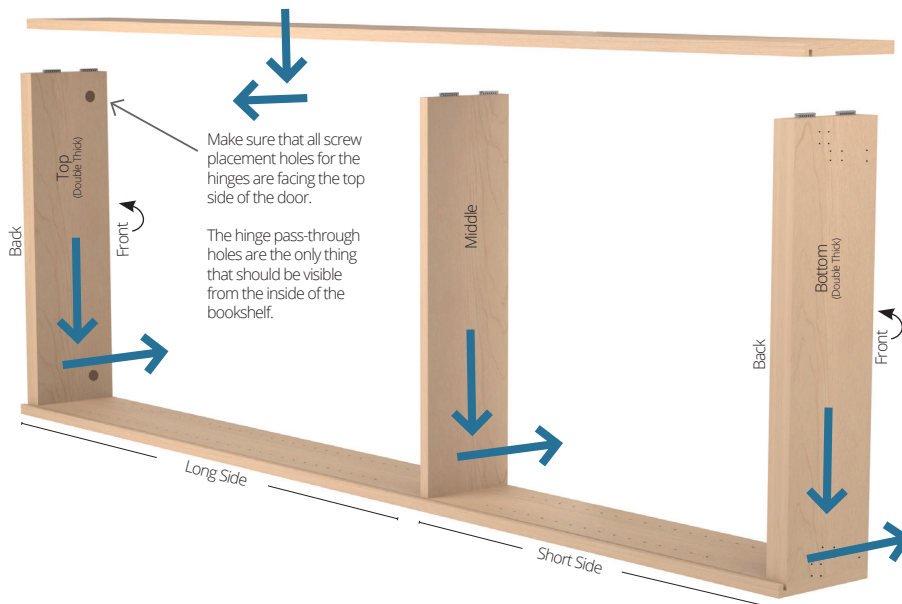

3 Set Shelves

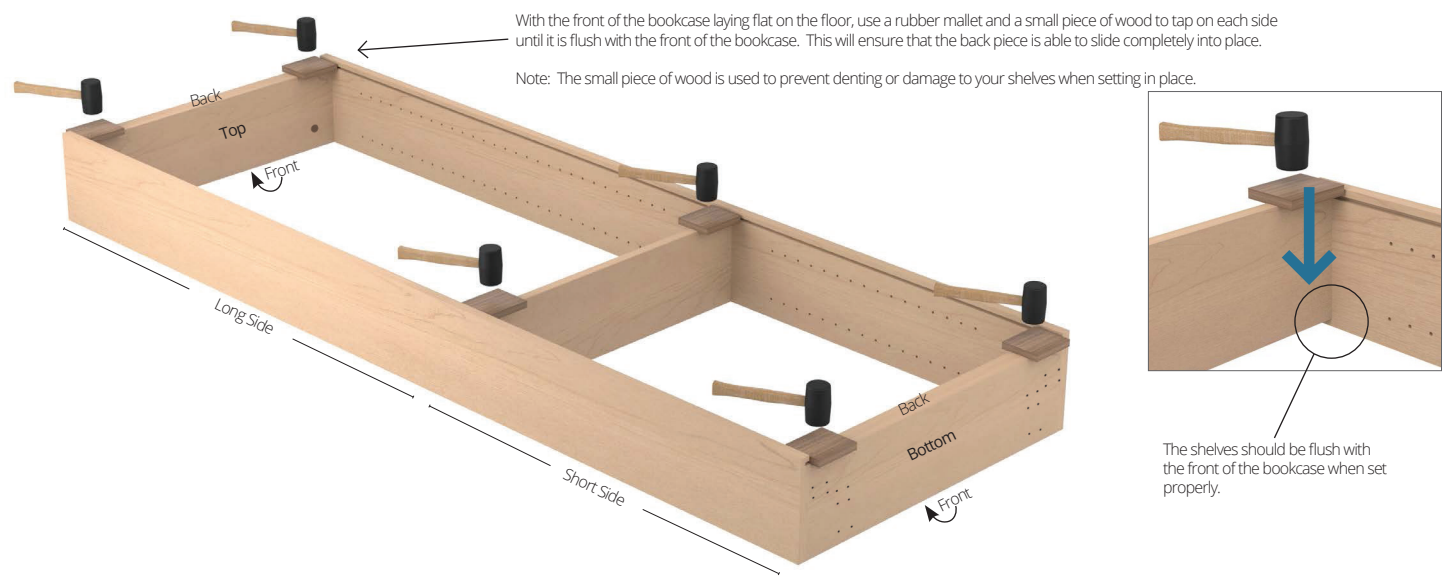

4 Place Back

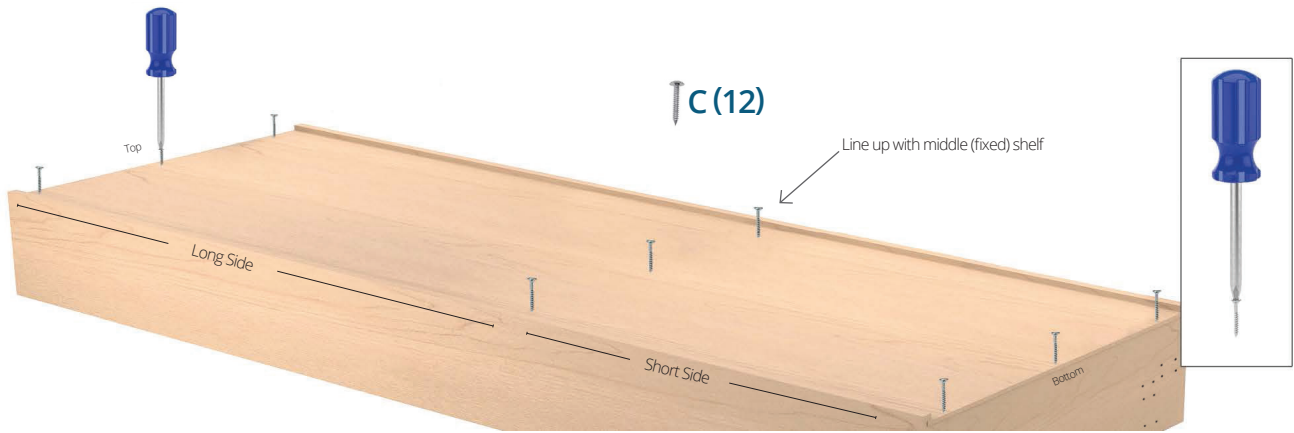
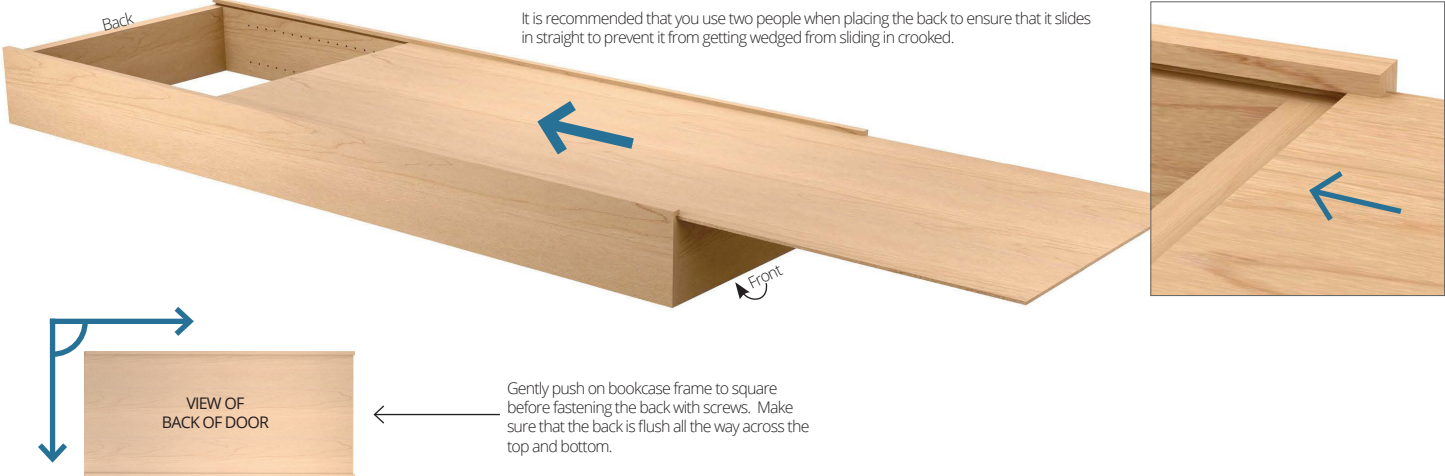

5 Fastening Face Frame

Make sure that all dowel holes are facing the front of the door.

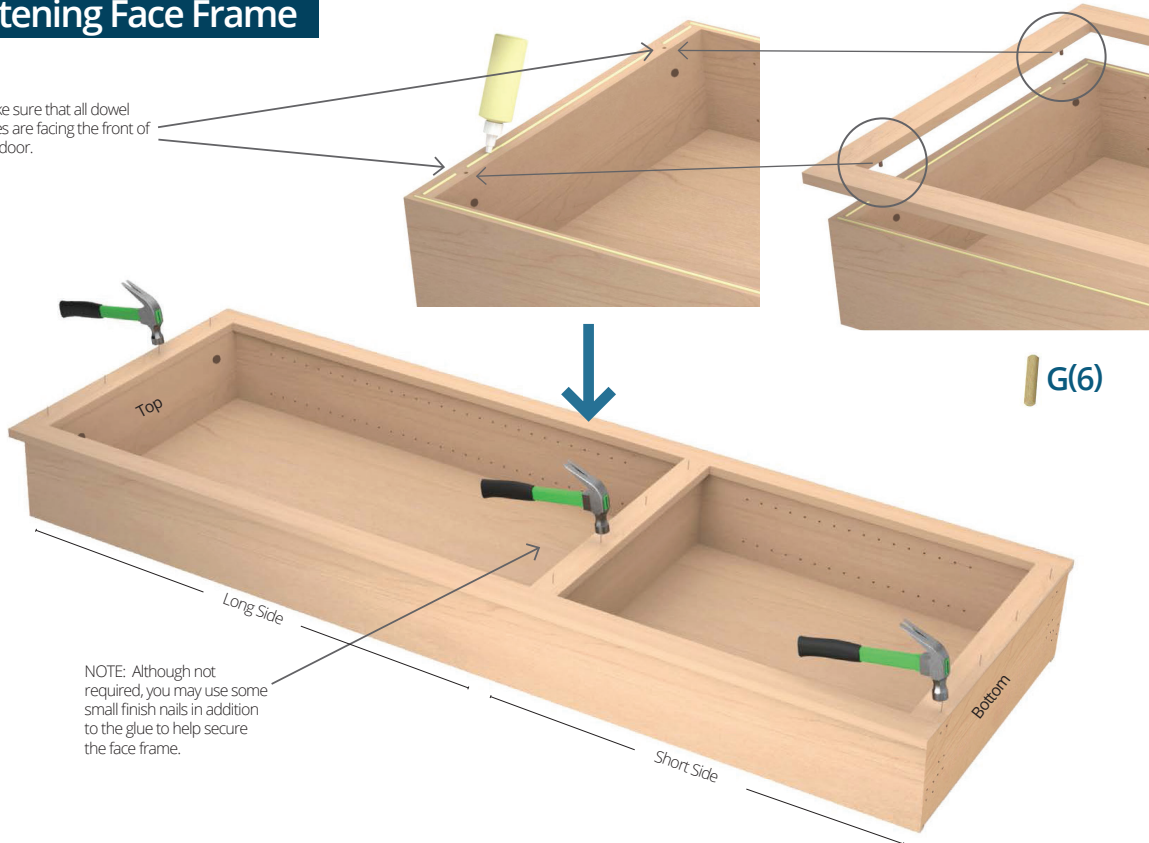

NOTE: Although not required, you may use some small finish nails in addition to the glue to help secure the face frame.

6 Hinge Templates

NOTICE: HINGE TEMPLATES ARE NEEDED FOR HARDWOODS ONLY

UPPER JAMB

- A** Place the template for your desired swing configuration onto the upper jamb. Drill the spots where the screws for the hinges will be located. For an out-swing configuration you will also need to drill through the entire upper jamb for the hinge pin to be able to pass through.



FRENCH DOOR UPPER JAMB

You will need to repeat the same process as above for the left and right sides of the upper jamb.



PAINT GRADE WITH PRE-DRILLED HOLES

Lower Jamb (Threshold) & Upper Jamb

Paint Grade doors come with the Lower/Upperjamb pre-drilled. To install the hinges, locate the side with the decal on it and flip it 180 degrees.

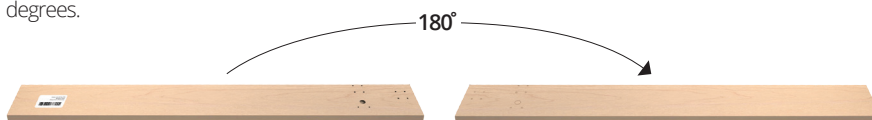

Use a nail or similar object to pop out the last remaining wood until the hole is unblocked.

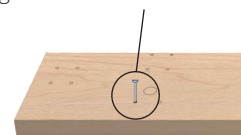

B Fasten hinge to upper jamb



FRENCH DOOR

You will need to repeat the same process as above for the left and right sides of the upper jamb.



C Rotate upper jamb 180 degrees so the hinge is on the underside of the upper jamb

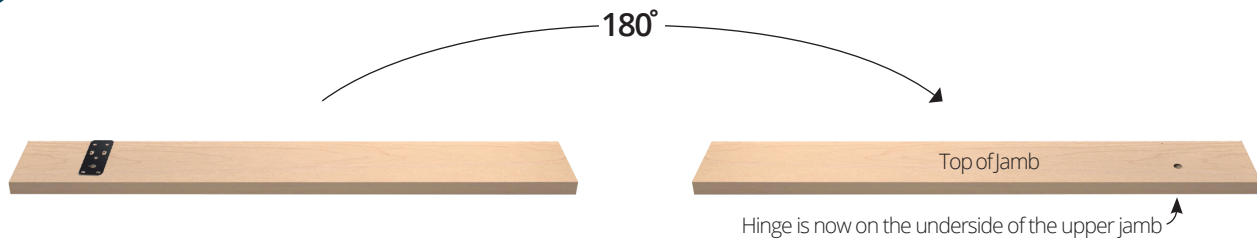

FRENCH DOOR

You will need to repeat the same process as above for the upper jamb of the french door.

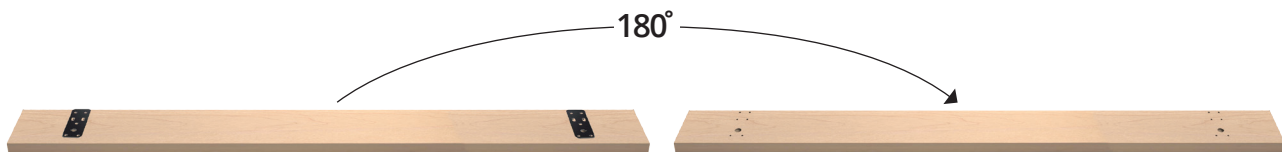

Lower Jamb (Threshold)

NOTICE: HINGE TEMPLATES ARE NEEDED FOR HARDWOODS ONLY

A Place the template for your desired swing configuration onto the lower jamb (threshold). Drill the spots where the screws for the hinges will be located.



FRENCH DOOR

You will need to repeat the same process as above for the left and right sides of the lower jamb (threshold).



B Fasten hinge to lower jamb (threshold)

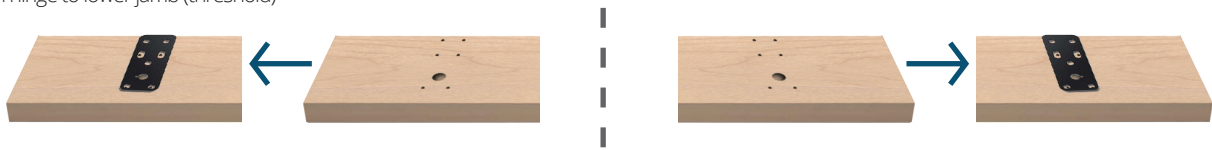

FRENCH DOOR

You will need to repeat the same process as above for the left and right sides of the lower jamb (threshold)



7 Assemble Jamb

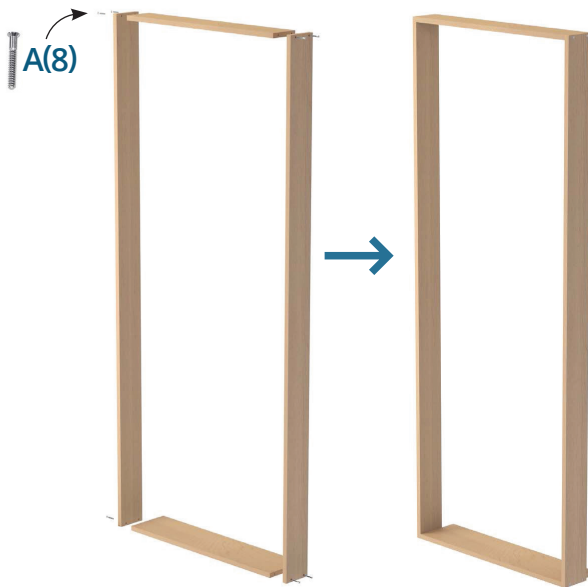

FRENCH DOOR

The jamb assembly for the French Door, is the exact same process as the Flush Mount door. The only difference is the length of the upper jamb and lower jamb (threshold).

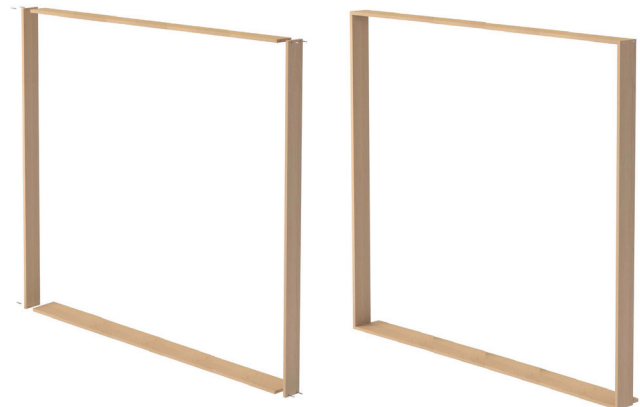

The Lower Jamb (Threshold) is wider than the rest of the jamb. Make sure that it is flush with the front and extends out the back side.

8 Trim / Casing

Trim/casing needs to overhang the door by 1/2". This can be adjusted as needed, just make sure that it covers the gap between the door and jamb.

IN-SWING - Trim/casing will be attached directly to the wall on all sides.

OUT-SWING - The left or right trim piece will need to be attached to the face frame of the door.

French doors will come with an extra trim piece for the center. This piece will be installed onto either the left or right door. Be sure to cut this piece so it will leave a 1/16" - 1/8" space at the top in order to clear the top trim when opening and closing the door.

NOTE: See photos on website for example

8 Out-Swing Hinges

LEFT HINGE OUT-SWING

RIGHT HINGE OUT-SWING

Placing Pin in Upper Hinge

- 1) Push in button on end of pin
- 2) Insert pin through hinge plates
- 3) Release button after pin has cleared both hinge plates
- 4) Ball bearings will expand to secure pin in place

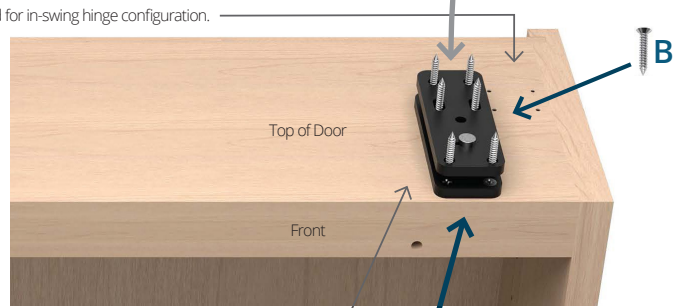
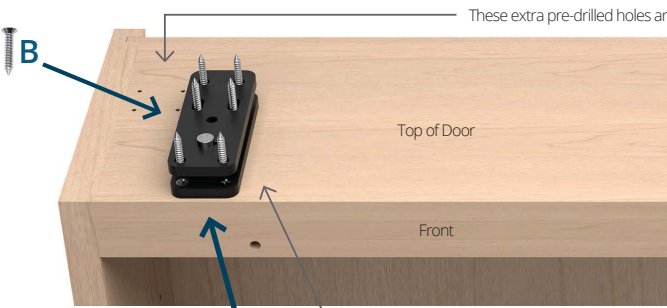

You may need to punch holes for hinge pin to pass through

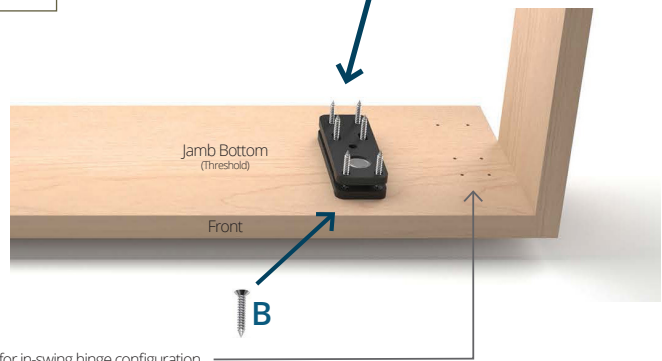
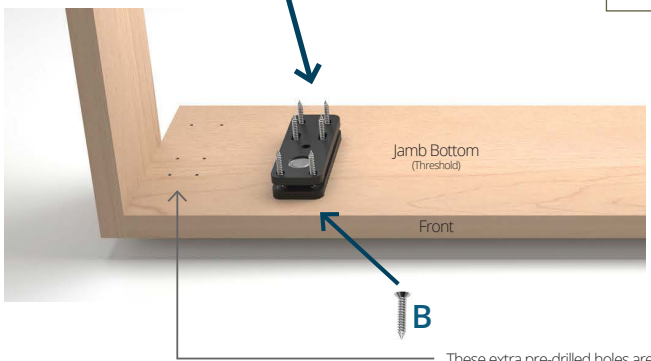
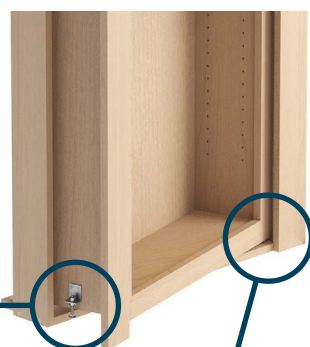
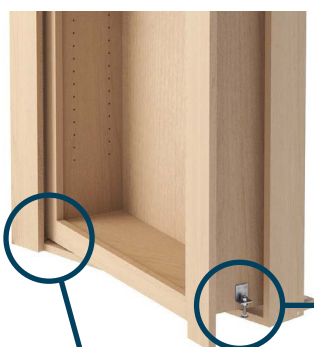

8 In-Swing Hinges

LEFT HINGE IN-SWING

RIGHT HINGE IN-SWING

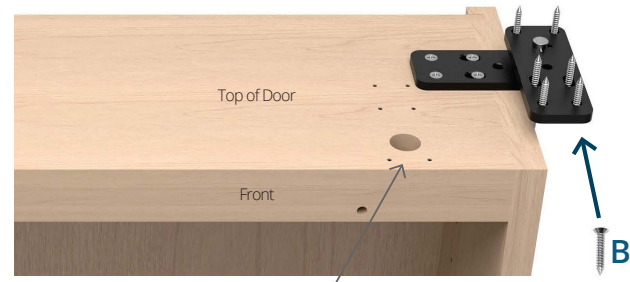
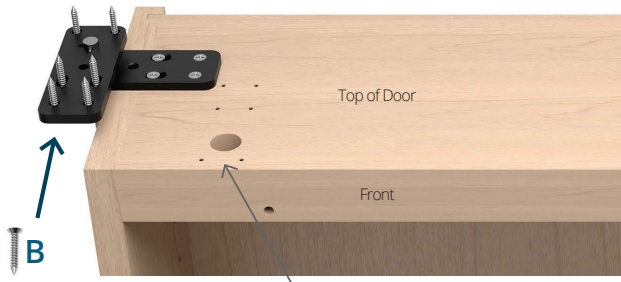

Pre-drilled pattern with hinge pin pass-through hole are only used for out-swing hinge configuration.

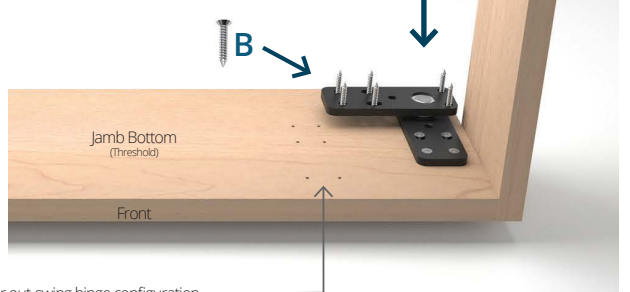
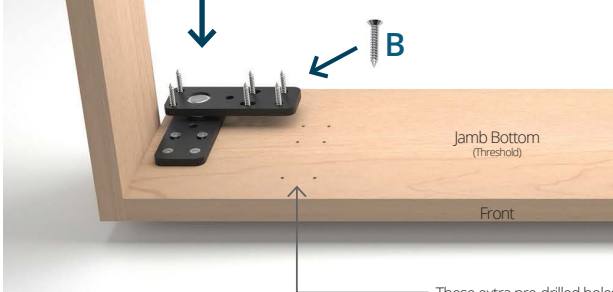
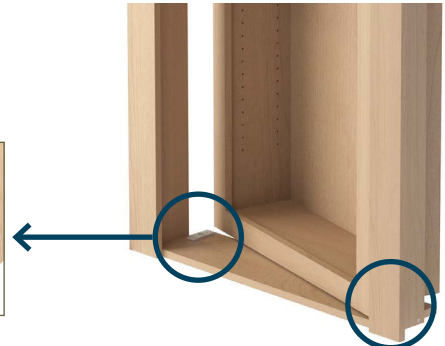
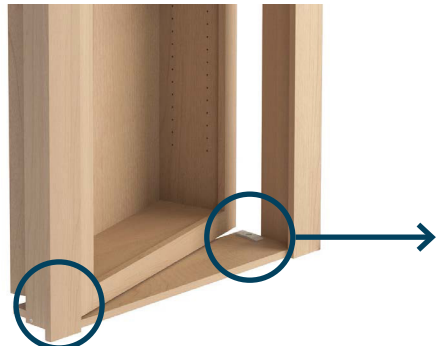

These extra pre-drilled holes are only used for out-swing hinge configuration.

DOOR BOTTOM

Hinges on Left

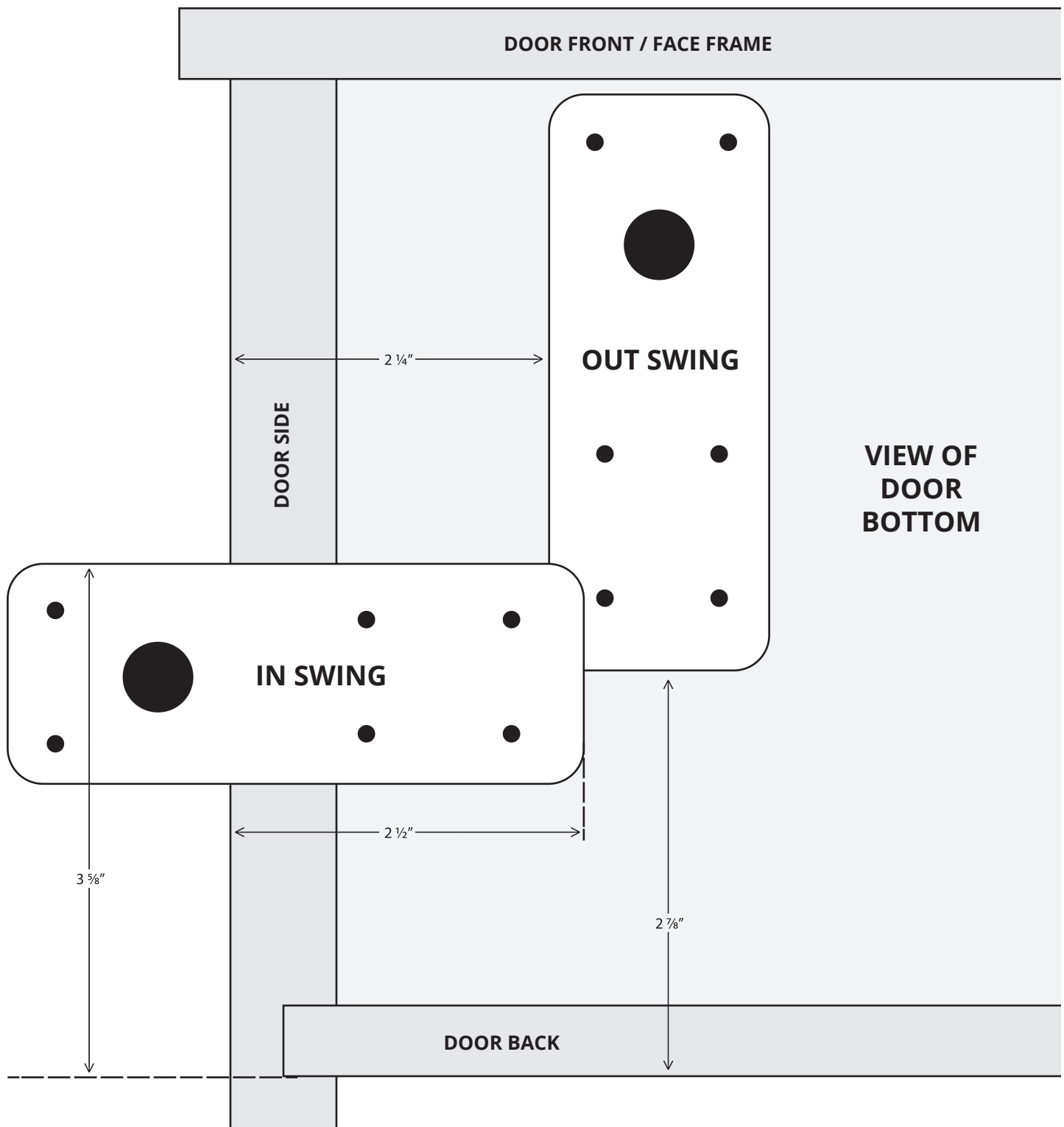

NOTICE: Due to variations in individual printer settings we cannot guarantee that the printed template will be scaled properly. Please use the included measurements to verify proper placement.

DOOR BOTTOM

Hinges on Right

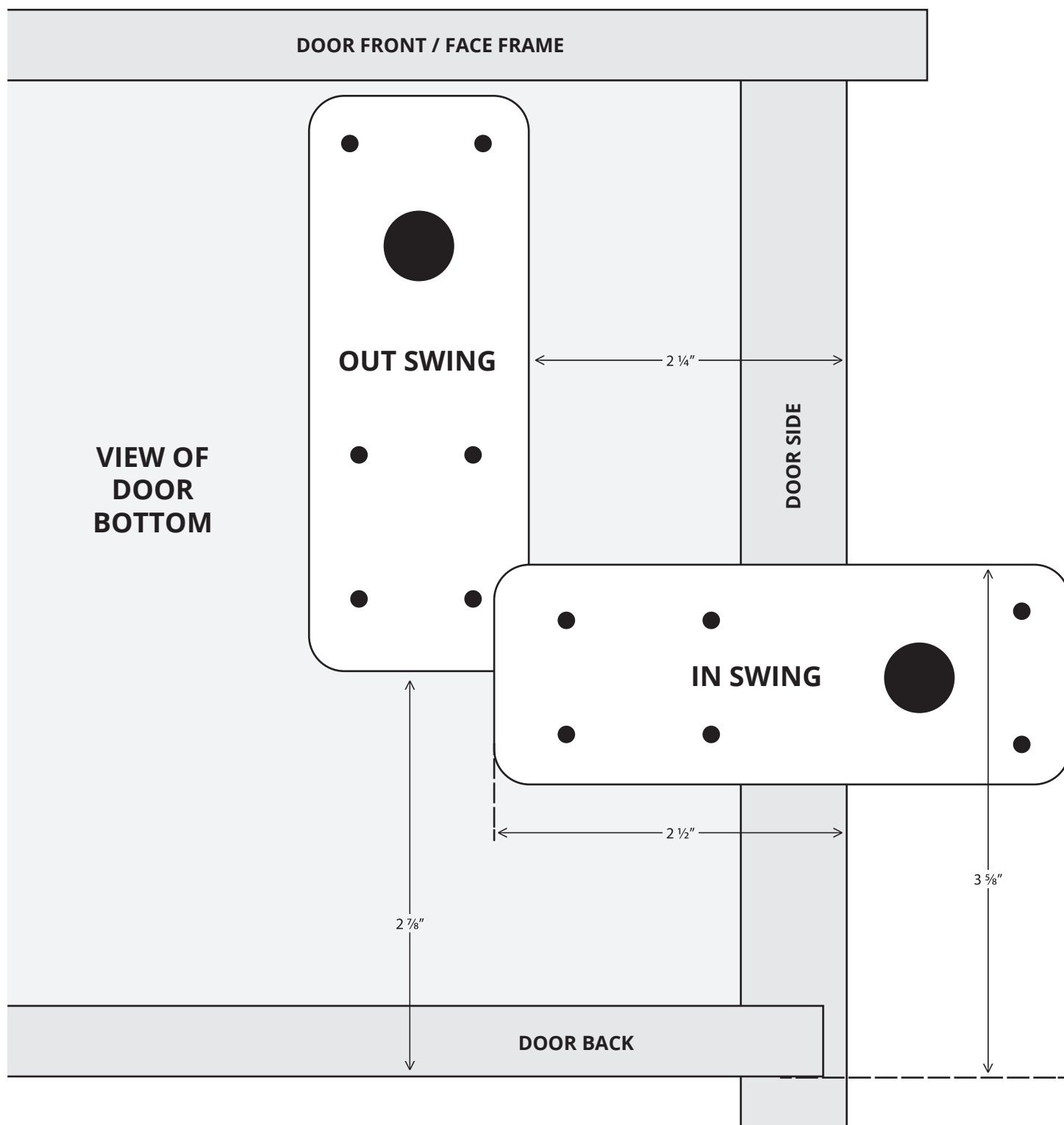

NOTICE: Due to variations in individual printer settings we cannot guarantee that the printed template will be scaled properly. Please use the included measurements to verify proper placement.

UPPER JAMB HINGE TEMPLATE

Hinges on Right



NOTICE: Due to variations in individual printer settings we cannot guarantee that the printed template will be scaled properly. Please use the included measurements to verify proper placement.

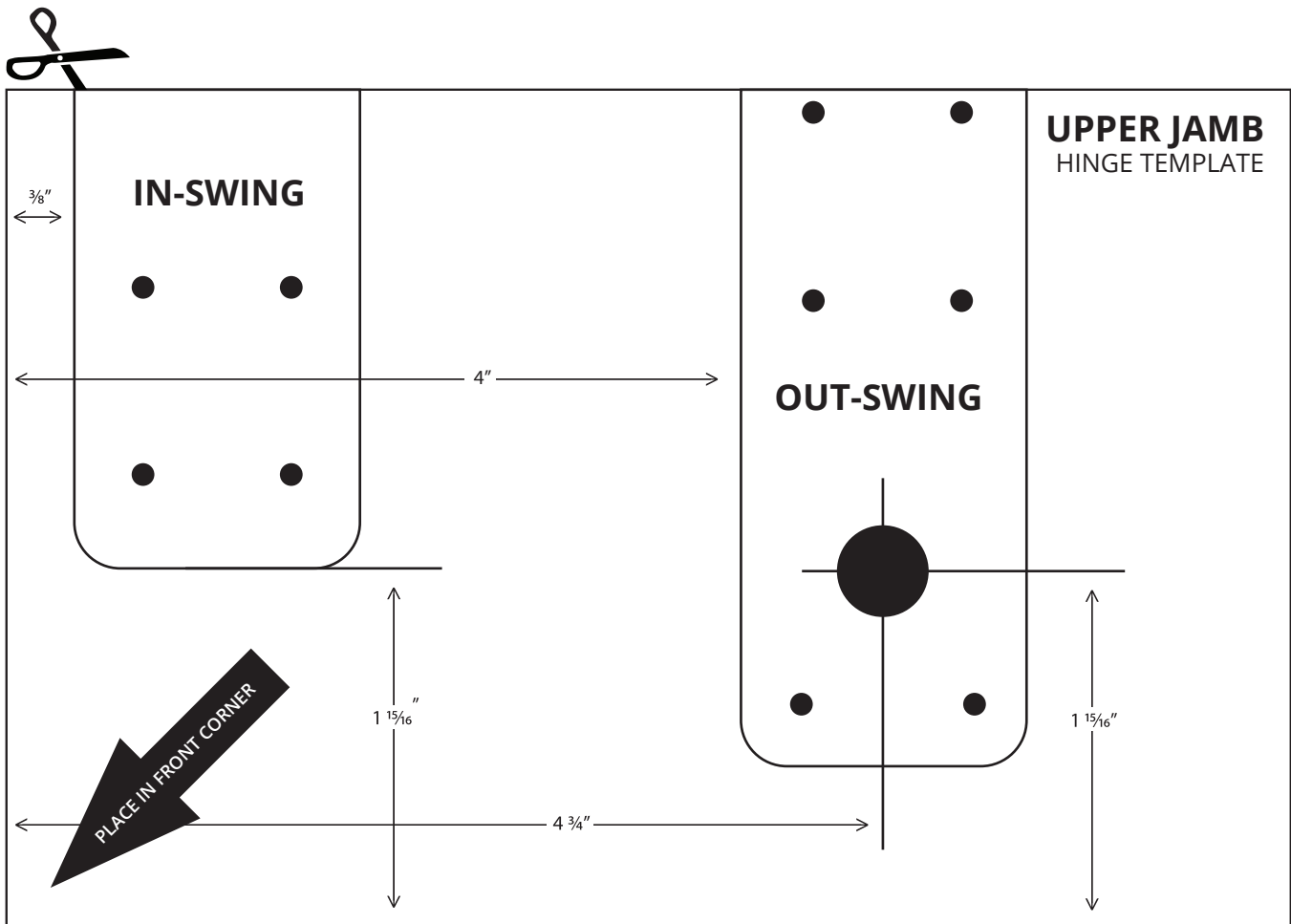

NOTE: After attaching the hinge to the upper jamb, before assembling the jamb, you must flip it 180 degrees so that the hinge piece is now on the underside of the upper jamb.

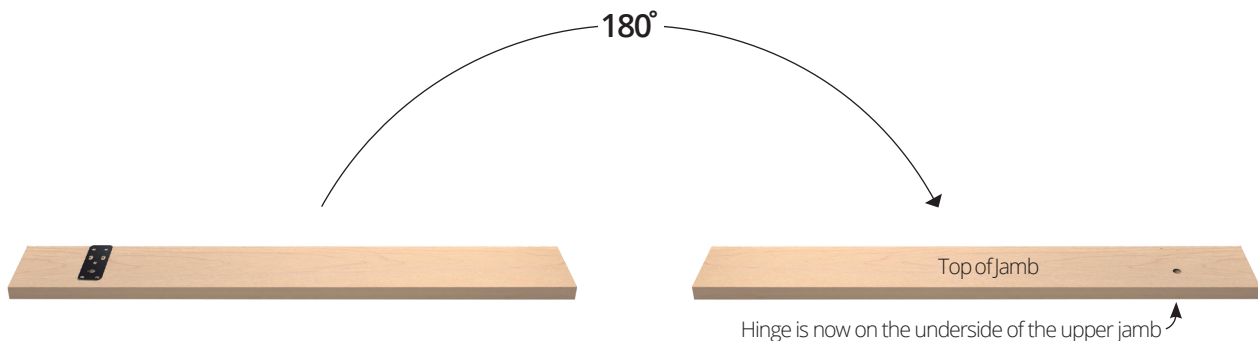

UPPER JAMB HINGE TEMPLATE

Hinges on Left



NOTICE: Due to variations in individual printer settings we cannot guarantee that the printed template will be scaled properly. Please use the included measurements to verify proper placement.

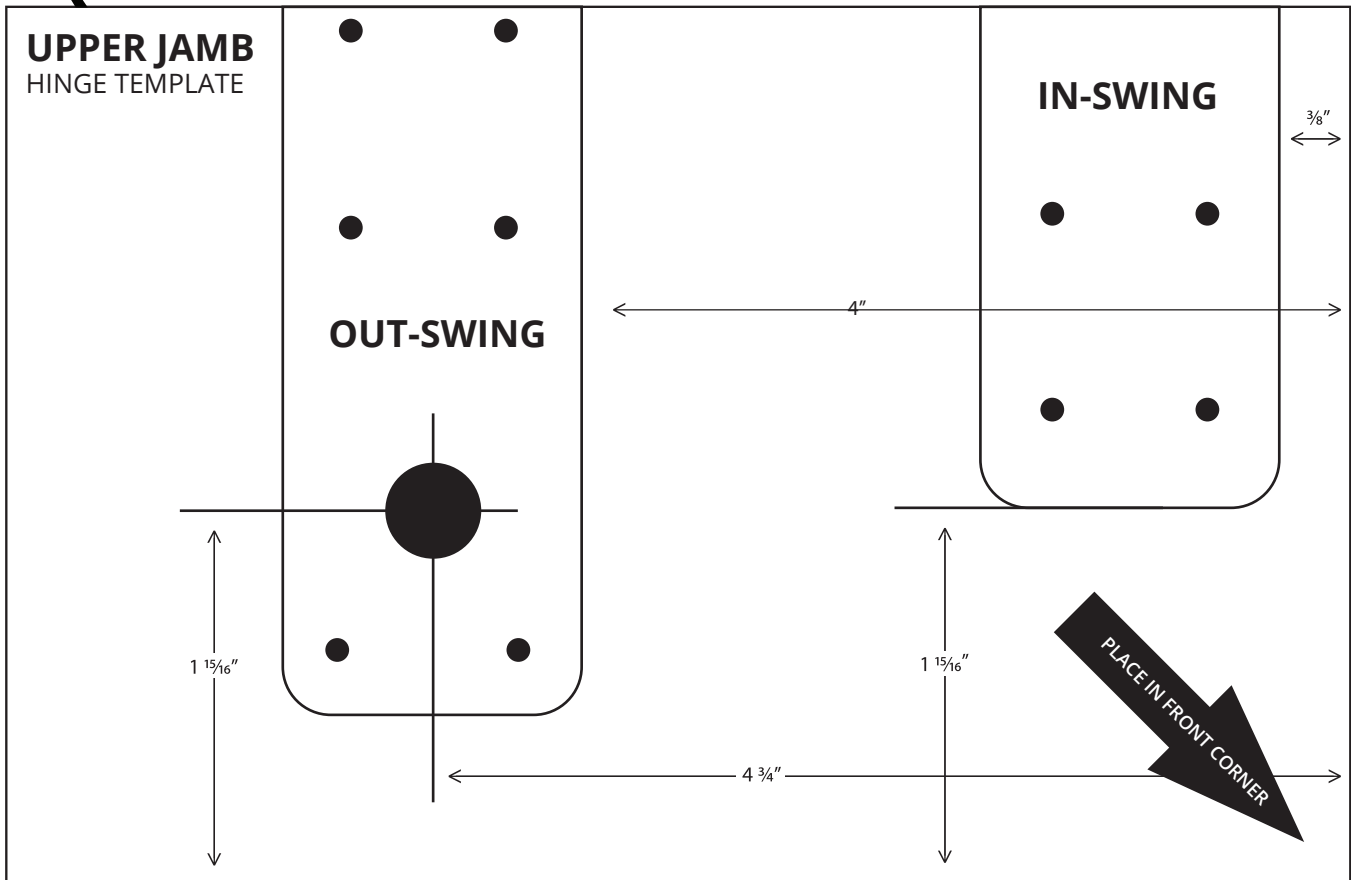

NOTE: After attaching the hinge to the upper jamb, before assembling the jamb, you must flip it 180 degrees so that the hinge piece is now on the underside of the upper jamb.

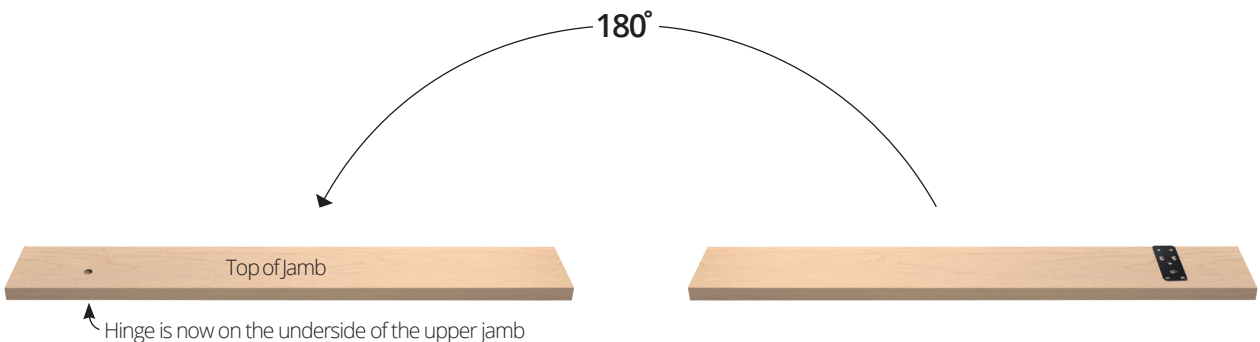

THRESHOLD HINGE TEMPLATE

Hinges on Right



NOTICE: Due to variations in individual printer settings we cannot guarantee that the printed template will be scaled properly. Please use the included measurements to verify proper placement.

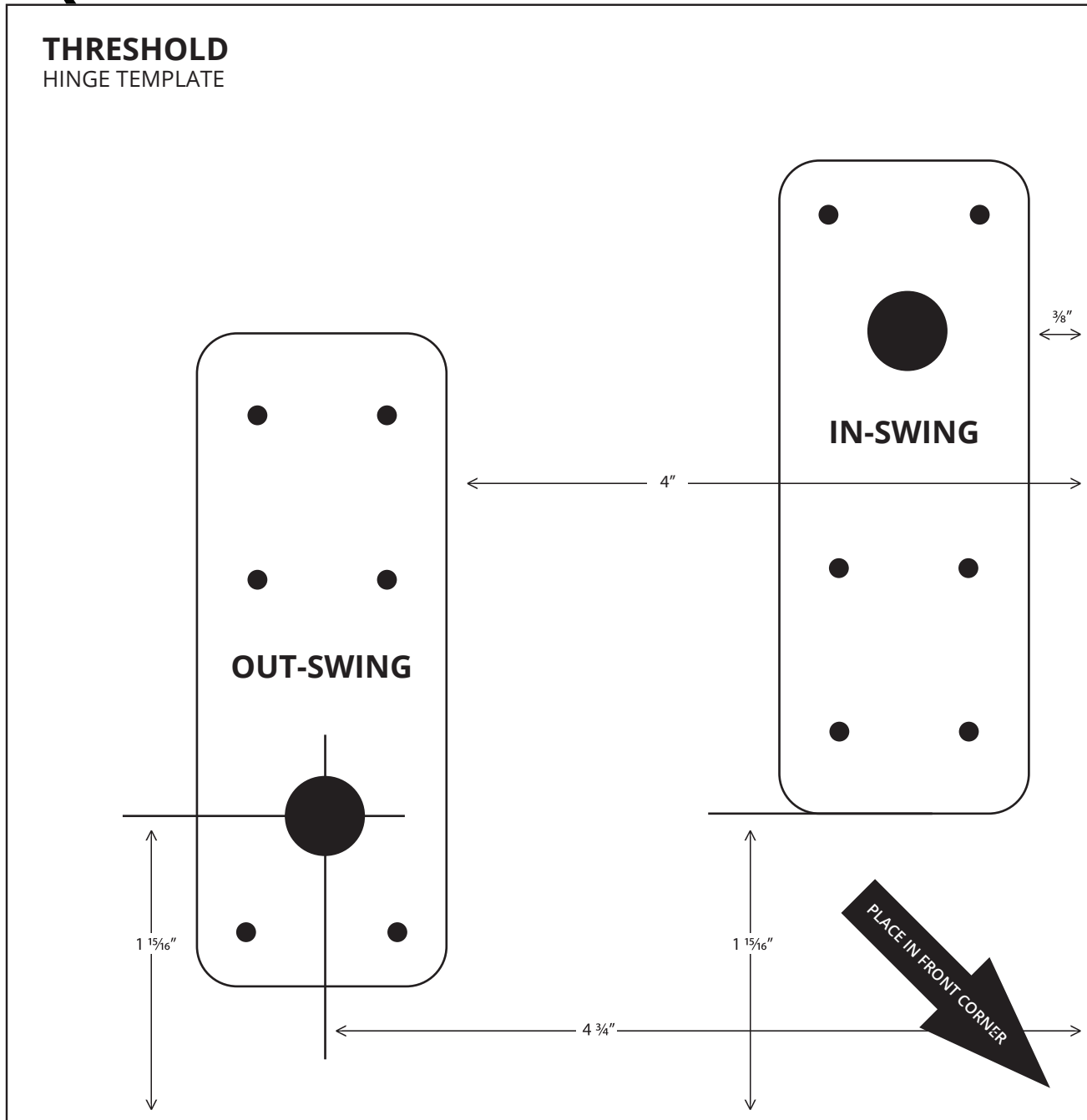

THRESHOLD HINGE TEMPLATE

Hinges on Left



NOTICE: Due to variations in individual printer settings we cannot guarantee that the printed template will be scaled properly. Please use the included measurements to verify proper placement.

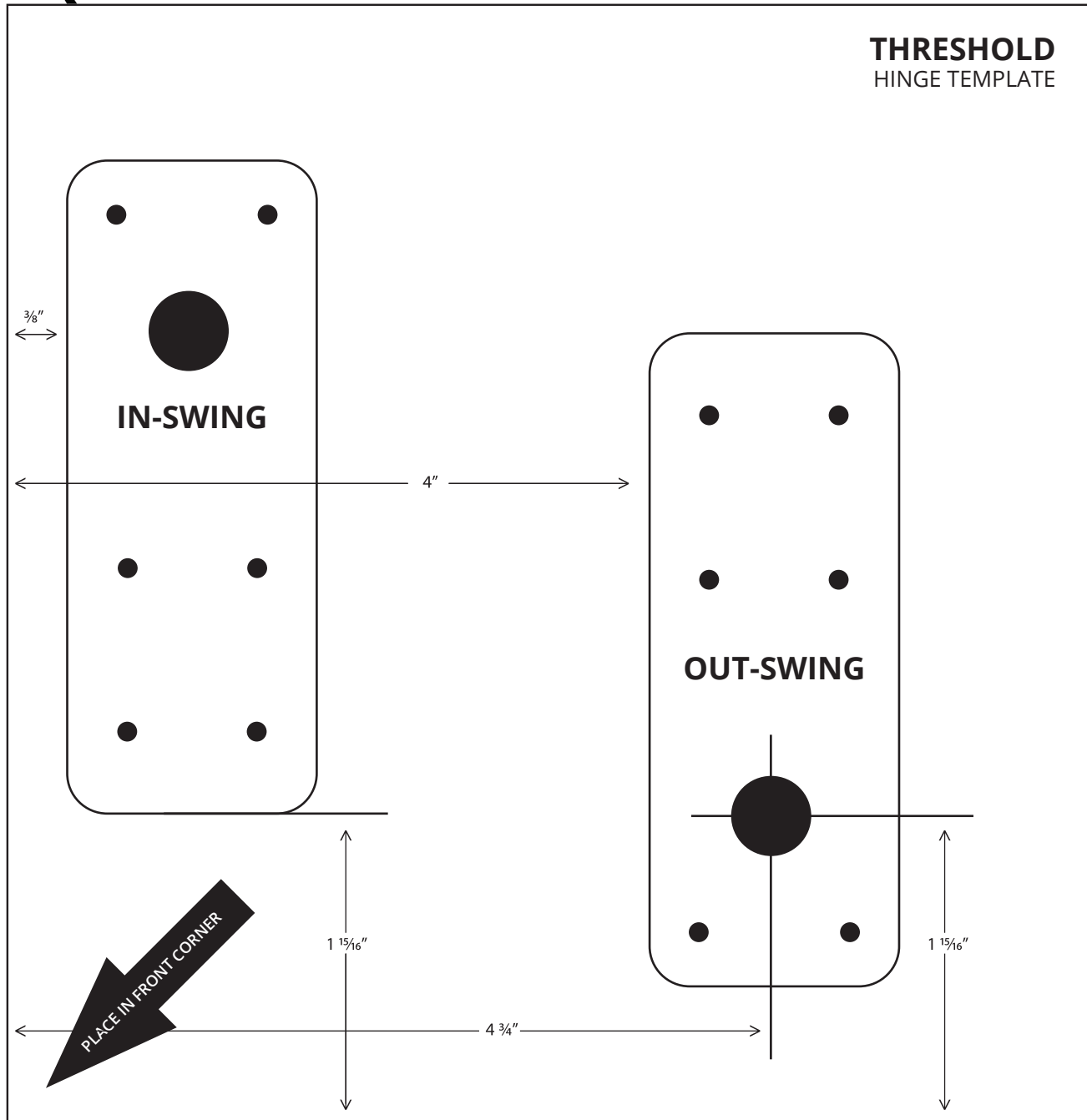



MURPHY DOOR™

CREATIVE DOOR SOLUTIONS



Ogden Headquarters
2541 Rulon White Blvd
Ogden, UT 84404



**Kentucky Distribution
Center & Showroom**
2320 Fortune Dr. #180
Lexington, KY 40509