

1616-36

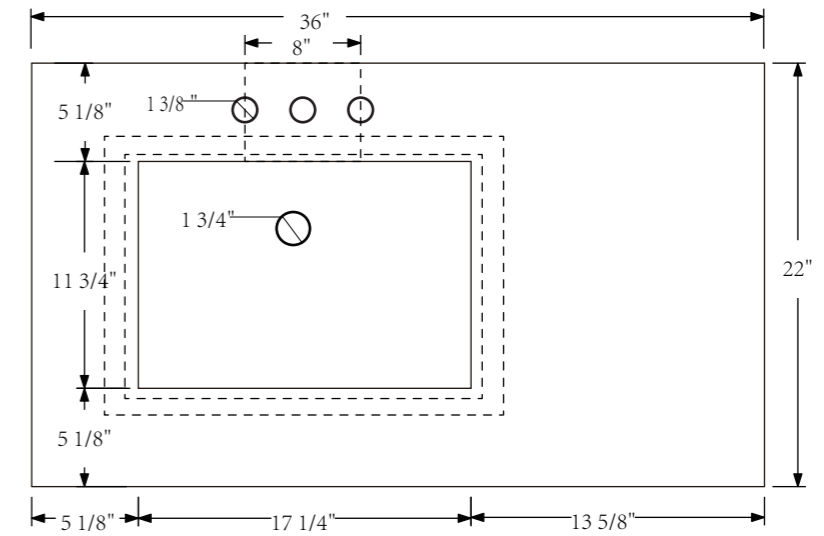

TOP VIEW

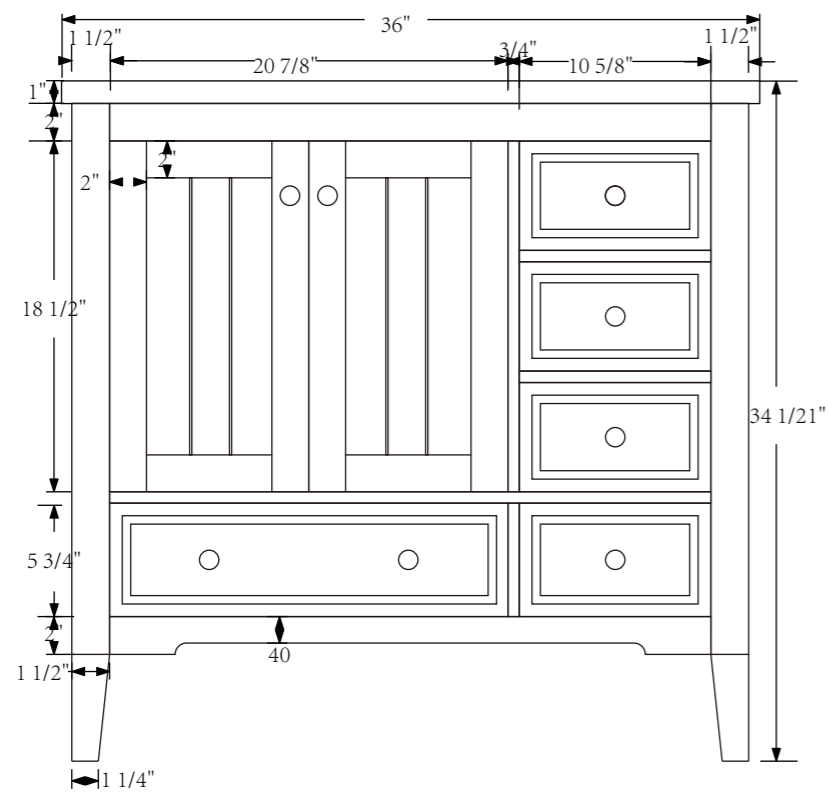

FRONT VIEW

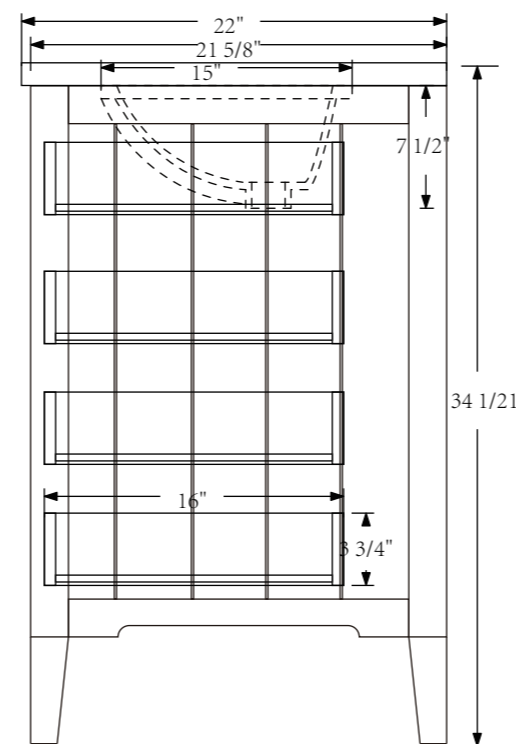

SIDE VIEW

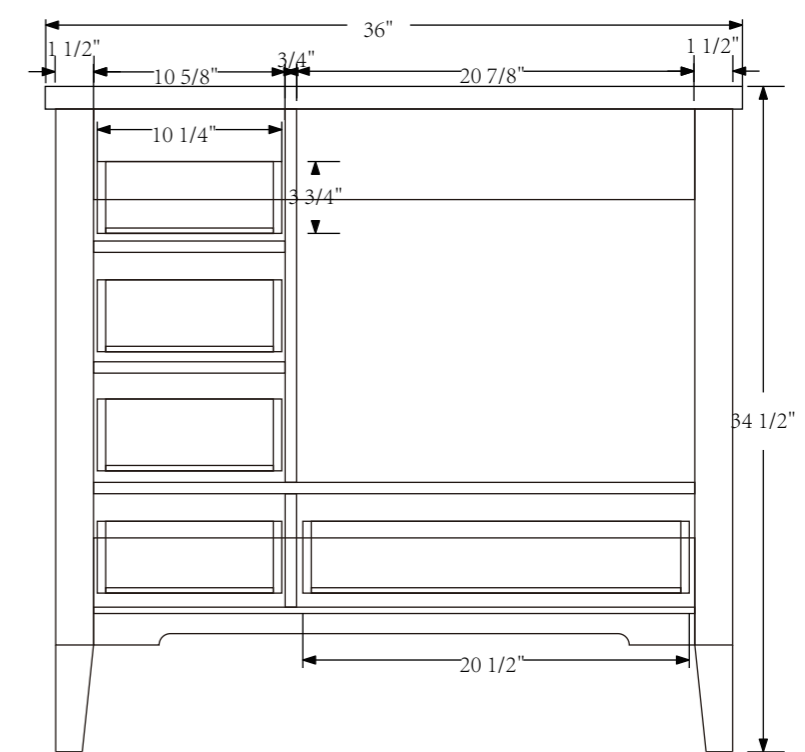

BACK VIEW