

**newair**<sup>®</sup>

**AH-470**

---

**Flat Panel Micathermic  
Space Heater**



**OWNERS MANUAL**

*Read and save these instructions.*



## A Name You Can Trust

Trust has to be earned and we will earn yours. Customer happiness is the focus of our business.

From the factory to the warehouse, from the sales floor to your home, the whole NewAir family promises to provide you with innovative products, exceptional service, and support when you need it the most.

### Count on NewAir.

As a proud NewAir owner, welcome to our family. There are no robots here, real people shipped your product and real people are here to help you.

Thank you for your purchase and remember NewAir, A Name You Can Trust.

Call us today at 855-963-9247  
Or email [support@newair.com](mailto:support@newair.com)

For future reference, we recommend you attach a copy of your sales receipt here and record the following information. You will need this information if it becomes necessary to contact the manufacturer for service inquiries.

Date of Purchase: \_\_\_\_\_

Serial Number: \_\_\_\_\_

Model Number: \_\_\_\_\_



Connect with us online.

<http://www.NewAir.com>

---

# READ AND SAVE THESE INSTRUCTIONS.

---

## TABLE OF CONTENTS

Before First Use.....	4
Safety Information & Warnings .....	4
Parts List.....	7
Assembly Instructions.....	8
Positioning of the Heater .....	8
Use & Operation .....	9
To Set the Thermostat .....	10
To Set the Timer.....	10
Safety Features .....	10
Overheat Protection .....	10
Safety Cut-Out Switch .....	11
Cleaning & Maintenance.....	11
Storage.....	11
Troubleshooting.....	12
Limited Manufacturer's Warranty .....	14

---

## SPECIFICATIONS

<b>MODEL NO.</b>	AH-470
<b>VOLTAGE</b>	120 Volts
<b>CURRENT</b>	12.5 Amps
<b>FREQUENCY</b>	60Hz
<b>POWER CONSUMPTION:</b>	1500 Watts

A NAME YOU CAN TRUST

## BEFORE FIRST USE

- Read and follow all the instructions below even if you feel you are familiar with the appliance.
- Remove the packing and make sure that the appliance is intact. If in doubt do not use the appliance and contact the place of purchase.
- Do not leave packaging materials such as bags and staples within reach of children.
- Dispose of packaging carefully and with consideration for the environment.
- It is ideal to retain the appliance carton for seasonal storage.
- For your convenience, record the date you received the appliance on the warranty page of these instructions, and attach your proof of purchase. Retain this information in the event that warranty service is required.

## SAFETY INFORMATION & WARNINGS



When using any electrical appliance, basic safety precautions must be followed in order to reduce the risk of fire, electrical shock and/or injury to persons or property. Be sure to read all instructions before using this appliance and observe the following safety tips:

### **Location and Grill Safety:**

- The appliance must not be located immediately below or in front of a socket-outlet.
- To avoid overheating, keep airflow grilles clear of dust and hair build up, especially if you have indoor pets.
- Do not cover or restrict airflow to the inlet or outlet grilles in any manner as the appliance may overheat and become a fire risk.
- Do not cover grilles, block entry or exits of airflow by placing the appliance against any surface. Keep all objects at least 1 meter from the front, side and rear of the appliance.

- Do not locate in areas of high foot traffic, ensure the power cord and heater are in view to avoid accidents.
- This appliance heats up when in use. To avoid burns, do not touch the front of the appliance or any of the grilles or vents.

**Keep away from water:**

- Do not operate in bathrooms, laundry areas or similar moist indoor locations.
- Never position the appliance where it may fall into a bath or other water container.
- Do not immerse in liquid or use the appliance near water as this could create an electrical shock hazard.
- If the appliance accidentally comes into contact with water switch off the power supply, do not touch the appliance.
- Do not operate the appliance with wet hands.

**Operation:**

- Do not connect the appliance to the main power supply until completely assembled and adjusted.
  - This appliance is not intended for outdoor use.
  - This appliance is intended for light domestic use and not for heavy duty commercial or industrial use.
  - Do not operate in areas where gasoline, paint or other flammable liquids are used or stored.
- Always operate upright, on a flat surface only.



**CAUTION:** This product is NOT suitable to be used on long pile carpets.

**Plug and Cord Safety:**

- Unroll the cord before operating. Operating with a coiled cord may cause overheating and fire risk.
- The use of an extension cord with this appliance is not recommended.

- Do not remove the plug from the power socket until the appliance has been switched off.
- Always hold the plug when removing it from the wall, do not pull the cord.
- Always unplug the appliance when it is not in use.
- Do not allow the cord to come into contact with the appliance surface during operation.
- Do not run the cord under carpeting, mats or rugs, etc. Arrange the cord away from traffic areas so that it will not be tripped over.
- Do not twist, kink or wrap the cord around the appliance as this may cause the insulation to weaken and split.
- Do not operate any appliance with a damaged cord or plug or after the appliance malfunctions or has been dropped or damaged in any manner. Return to a qualified electrical person for service or repair.

**Other Tips:**

- Use only the voltage specified on the rating label of the appliance.
- Before moving the appliance, switch off the appliance by unplugging it from the wall and allowing it to cool.
- Do not use the appliance to dry clothes.
- Do not insert or allow foreign objects or metal utensils into any ventilation or exhaust openings as this may cause an electric shock, fire or damage to the appliance.

**Not intended for use by children:**

- This appliance is not intended for use by young children or infirm persons without supervision.
- Do not use this appliance with any type of external timer.
- Never remove the cover of the appliance – in case of a fault contact a qualified service person.
- Use this appliance only as described in this manual.
- Any other use is not recommended by the manufacturer and may cause fire, electric shock or injury.

## PARTS LIST

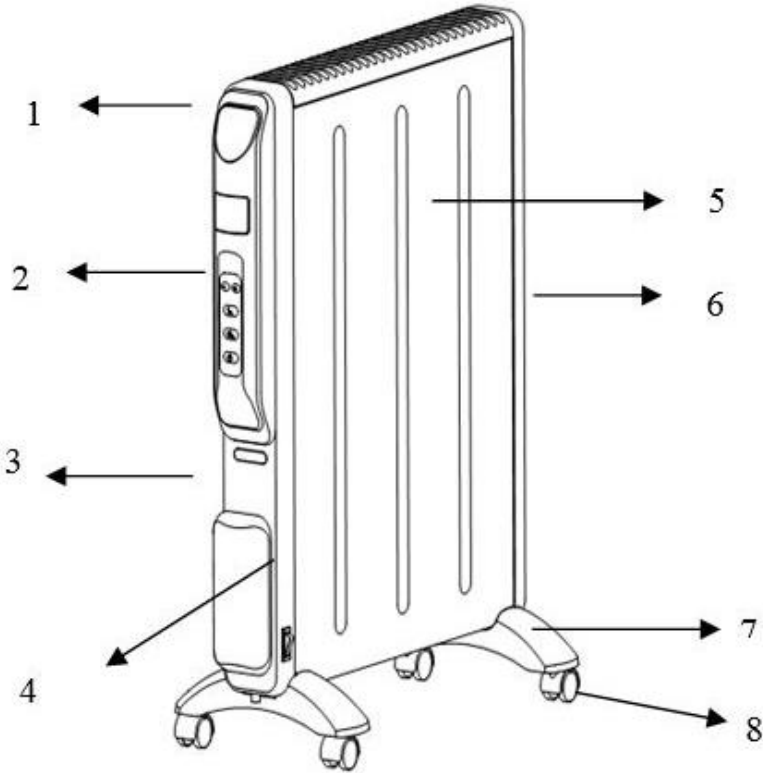

- |                                     |                  |
|-------------------------------------|------------------|
| 1. LOGO Plate                       | 5. Mesh          |
| 2. Control                          | 6. Plastic frame |
| 3. Storage location of<br>plug cord | 7. Feet base     |
| 4. Manual-reset rocker<br>switch    | 8. Wheels        |

## ASSEMBLY INSTRUCTIONS

1. Position the heater carefully upside down.
2. Place the wheels to the hole, then screw in center round hole of foot base and screw in tightly with a screwdriver.

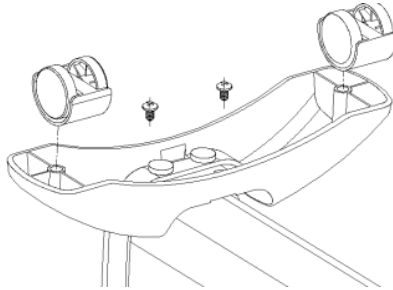

3. Repeat for other leg
4. Turn the heater the right way up.

---

## POSITIONING OF THE HEATER

The heater should only be operated at a minimum distance of 1 meter from any wall or other object. Position the air flow in order to optimize the heating of the room.



## USE & OPERATION

NOTE: When operated for the first time a slight odor may be emitted for a few minutes. This is harmless and occurs with most appliances as slight traces of dust or lubricants may have collected during the manufacturing process.

- Turn on the rocker switch at the side of the appliance adjacent to the main cable entry.
- The display will light briefly.
- Press the button  to switch the appliance ON.

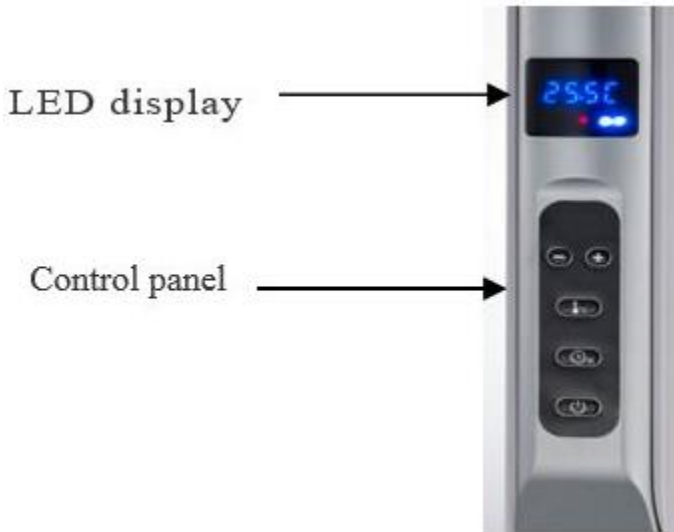

- The digital display will display the room temperature.
- The + / - button can be used to select full power or half power. This is indicated by the segments to the right of the flame symbol.



---

## TO SET THE THERMOSTAT

Press the  button, then press the + or - buttons to change the target temperature. The thermometer symbol will illuminate, and the digital display will flash, showing the target temperature. After 5 seconds the display will stop flashing and return to displaying the room temperature. It can be set from 41F-96.8F

---

## TO SET THE TIMER

- Press the  button. The clock symbol will illuminate. Then use the +/- buttons to set the number of hours for which the heater is to run before automatically switching off. It can be set from 0.5-18 hours.
- Unplug the appliance when not in use. The cable can be wrapped around the plastic cable storage location on the front panel.
- The heater operates when both the power switch and thermostat function are activated.
- The red indicator light will turn on and will be on as long as the plug is in the socket, even if the appliance does not operate.
- To switch the heater off fully, press the  button.

## SAFETY FEATURES

---

### OVERHEAT PROTECTION

- This heater is protected with an over-heat protection mechanism that switches it off automatically if it over-heats.
- Overheating can be caused by obstruction to the air intakes on the back of the heater or the grill on the front.
- If this occurs please disconnect the heater from the power supply and allow it to cool for 30 minutes. Remove any obstruction and turn the heater back on.
- The heater should operate normally.
- Should the problem persist, contact your nearest service center.

---

## SAFETY TIP-OVER SWITCH

- The heater is fitted with a safety tip-over switch to turn the heater off if it is knocked over.
- If the heater is knocked over and the tip-over switch activates, turn the heater off at the power outlet and take EXTREME care when standing the heater upright as it will still be hot.
- Inspect the heater for damage, especially the heating elements and supply cord.
- If any damage is visible, do not operate the heater.

## CLEANING & MAINTENANCE

IMPORTANT: Turn off the heater. Switch off the power switch and disconnect the heater from the power socket. Wait for the heater to be completely cool before cleaning.

- Vacuum clean air vents and grilles to remove dust from these areas.
- To remove dust on external surfaces, wipe the heater with a damp (not wet) lint-free cloth rinsed in hot soapy water only.
- Do not use any harsh detergent or abrasive cleaners.
- Do not spray with liquids or submerge in liquids or water.
- Do not attempt to clean the interior of the heater.
- Do not attempt to open the heater casing at any time.

---

## STORAGE

Store the heater carefully in a dust-free area during the off season. It is ideal to store the heater in the carton it was supplied in. Neatly wrap the cord of the heater to prevent damage to the cord.

## TROUBLESHOOTING

Problem	Possible Causes	Solution
<b>Unit is not heating.</b>	Overheat protection has temporarily deactivated the heater.	Turn the heater off; unplug it and allow it to cool. Inspect and remove any objects on or adjacent to the heater. Wait 30 minutes before plugging unit back in.
	Room temperature has been warmed up to thermostat setting.	To increase the room temperature, adjust thermostat using the appropriate buttons to a higher setting.
	Heater is not plugged into a 120 volt grounded outlet/receptacle.	Ensure unit is turned OFF. Plug unit in to correct power outlet and attempt to turn on again.
	Breaker/Fuse has been tripped.	Check your electrical box to confirm the breaker has not been tripped. This may occur if the receptacle is shared by other high consumption appliances.

Problem	Possible Causes	Solution
<p><b>The heater is producing a burning smell.</b></p>	<p>A drop of oil fell on the heating coil during the manufacturing process.</p>	<p>It will quickly evaporate and should not occur again. Ensure room in which heater is situated is well ventilated.</p>
	<p>Ensure there are no combustible materials within 3 feet (0.9 meters) surrounding the heater.</p>	<p>Check for and remove any combustible items from the heater.</p>
	<p>Ensure a minimum clearance of 5.5 inches (14 cm) from both sides and rear of heater to adjacent walls.</p>	<p>Reposition the heater so there is enough space around the heater to the adjacent walls.</p>

**Please do not attempt to open or repair the heater yourself.  
Doing so could cause damage or personal injury.**

## LIMITED MANUFACTURER'S WARRANTY

This appliance is covered by a limited manufacturer's warranty. For one year from the original date of purchase, the manufacturer will repair or replace any parts of this appliance that prove to be defective in materials and workmanship, provided the appliance has been used under normal operating conditions as intended by the manufacturer.

### **Warranty Terms:**

During the first year, any components of this appliance found to be defective due to materials or workmanship will be repaired or replaced, at the manufacturer's discretion, at no charge to the original purchaser. The purchaser will be responsible for any removal or transportation costs.

### **Warranty Exclusions:**

The warranty will not apply if damage is caused by any of the following:

- Power failure
- Damage in transit or when moving the appliance
- Improper power supply such as low voltage, defective household wiring or inadequate fuses
- Accident, alteration, misuse or abuse of the appliance such as using non-approved accessories, inadequate air circulation in the room or abnormal operating conditions (extreme temperatures)
- Use in commercial or industrial applications
- Fire, water damage, theft, war, riot, hostility or acts of God such as hurricanes, floods, etc.
- Use of force or damage caused by external influences
- Partially or completely dismantled appliances
- Excess wear and tear by the user

### **Obtaining Service:**

When making a warranty claim, please have the original bill of purchase with purchase date available. Once confirmed that your appliance is eligible for warranty service, all repairs will be performed by a NewAir™ authorized repair facility. The purchaser will be responsible for any removal or transportation costs. Replacement parts and/or units will be new, re-manufactured or refurbished and is subject to the manufacturer's discretion. For technical support and warranty service, please email [support@newairusa.com](mailto:support@newairusa.com).