

DESCRIPTION

- Metal construction with various finishes identified by suffix
- Flexible supply lines with 3/8" compression fittings
- With side spray for 87202 series
- Side Spray with direct connect onto valve body installation

OPERATION

- Lever style handle
- Temperature controlled by 100° arc of handle travel
- Will operate with less than 5 lbs. of force

FLOW

- Aerator is limited to 1.5 gpm max (5.7 L/min)

CARTRIDGE

- 1255™ Duralast™ cartridge
- Nonmetallic/nonferrous and stainless steel material

STANDARDS

- Third party certified to ASME A112.18.1/CSA B-125.1 and all applicable requirements certified to NSF 61/9 & 372
- Meets CalGreen and Georgia SB370 requirements
- Complies with California Proposition 65 and with the Federal Safe Drinking Water Act
- **ADA** ♿ for lever handle

WARRANTY

- Lifetime limited warranty against leaks, drips and finish defects to the original homeowner
 - 10 year limited warranty when used in a multifamily installation
 - 5 year limited warranty when used in a commercial installation
- Visit www.moen.com/support for complete details and limitations

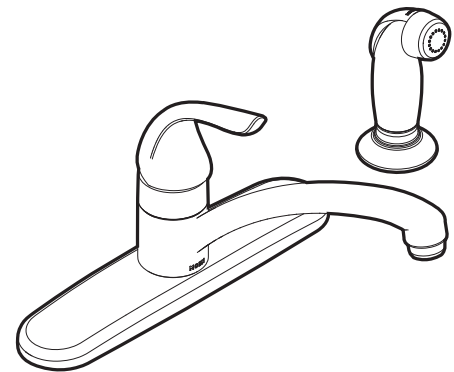

Adler™
Single-Handle Lever Kitchen Faucet

Models: 87202 series with Side Spray
87201 series less Side Spray

NOTE: DESIGNED TO INSTALL THROUGH
3 OR 4 HOLES 1-1/4" (32mm) MIN. DIA. AND
4" (102mm) ON CENTER

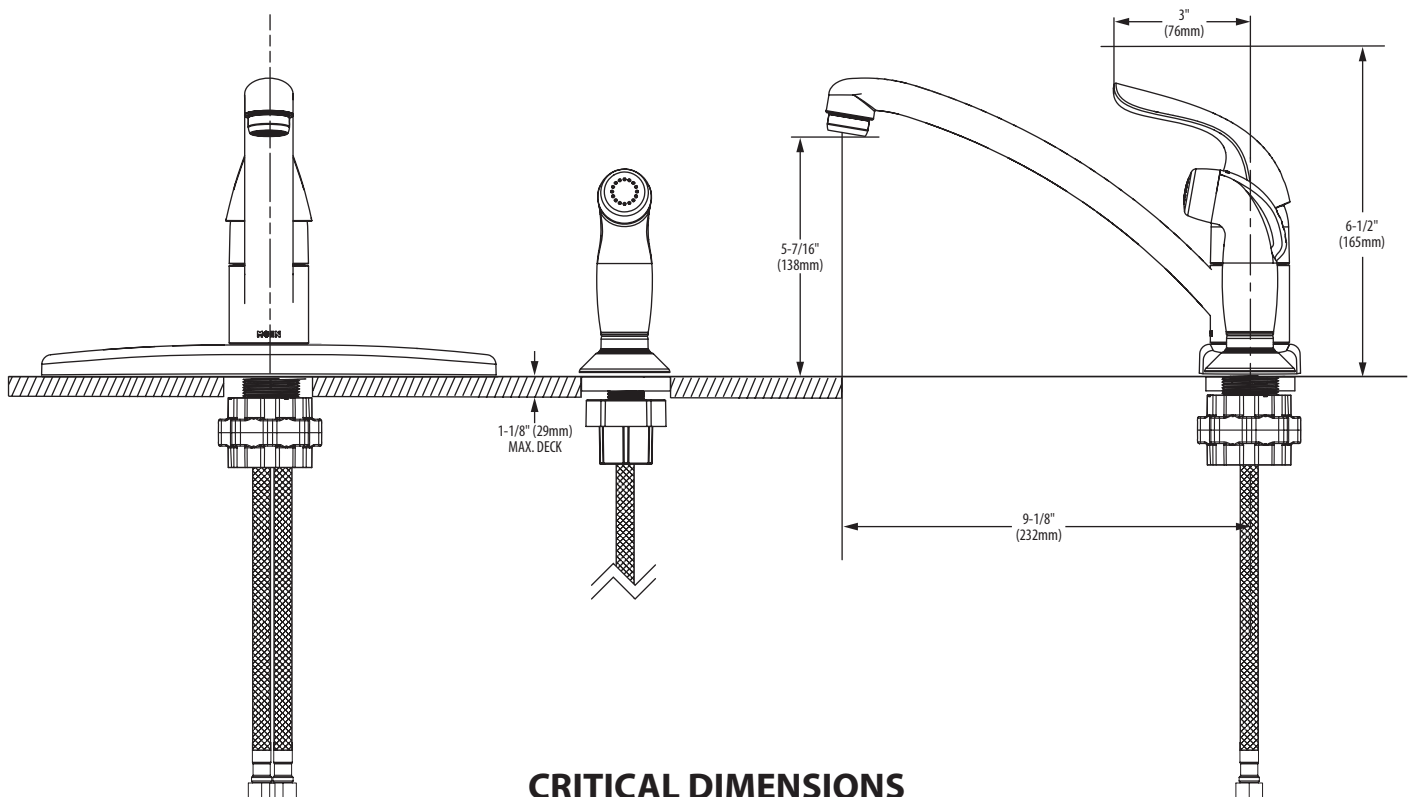

CRITICAL DIMENSIONS

(DO NOT SCALE)