

88 5004 692 Pantry

IMPORTANT NOTE

Carefully remove all the parts from the carton and put them individually on a soft cloth to prevent scratches or other damages occurring to the parts.

We have taken great care in the design of this product and request that you carefully and strictly follow our assembly instructions to ensure a completed product as it was designed.

Home Styles

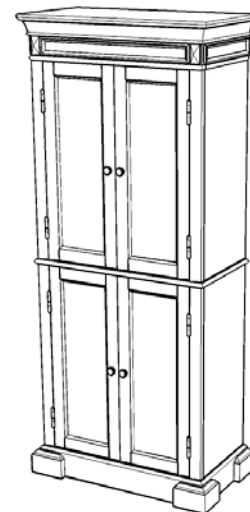

Part List



A.
Top
1 pc.

B.
Side Panel
2 pcs.

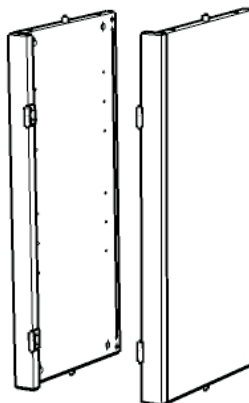

C.
Side Panel
2 pcs.



D.
Back Stretcher
4 pcs.



G.
Base
1 pc.

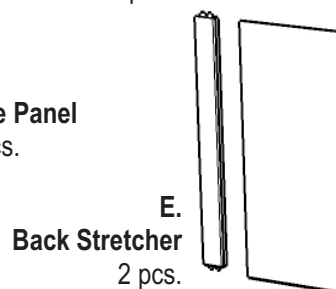

E.
Back Stretcher
2 pcs.

F.
Back Panel
4 pcs.

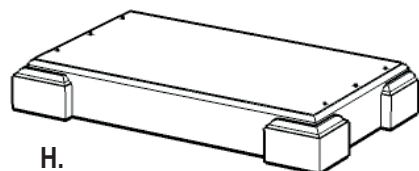

H.
Base
1 pc.



I.
Shelf
4 pcs.

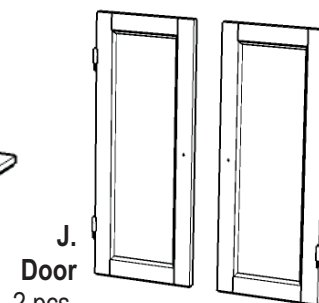

J.
Door
2 pcs.

K.
Door
2 pcs.

Hardware List



Cam Lock
24 pcs. (+1 extra)

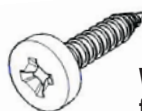

**Wood Screw
for Back Panel**
16 pcs. (+1 extra)



Machine Screw
4 pcs.

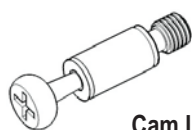

Cam Lock Screw
24 pcs. (+1 extra)



Adjustable Pin
16 pcs. (+2 extra)



**Door
Pull Handle**
4 pcs.

Tools required for assembly : **Phillips** screwdriver

Tools recommended for assembly : Level

Home Styles Consumer Assistance Line 888-680-7460 and 877-831-0319

servicedesk@homestyles-furniture.com

Revised date : 15May2012

Assembly Instructions 2/5

IMPORTANT

- * Do not tighten up all the screws until each part is properly assembled.
- * You should keep Hex Wrench in a safe place as you may need to tighten up the Head Cap Bolts in the future.
- * After assembly item must be level to work properly. Use the included adjustable levelers to level.

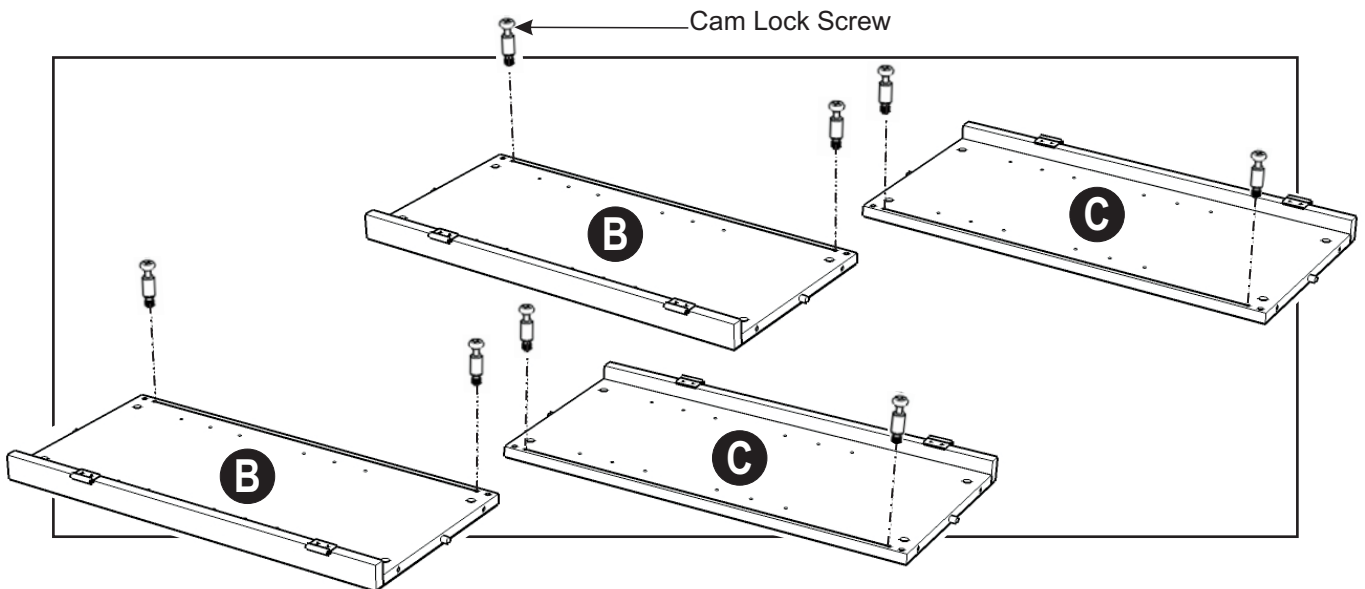
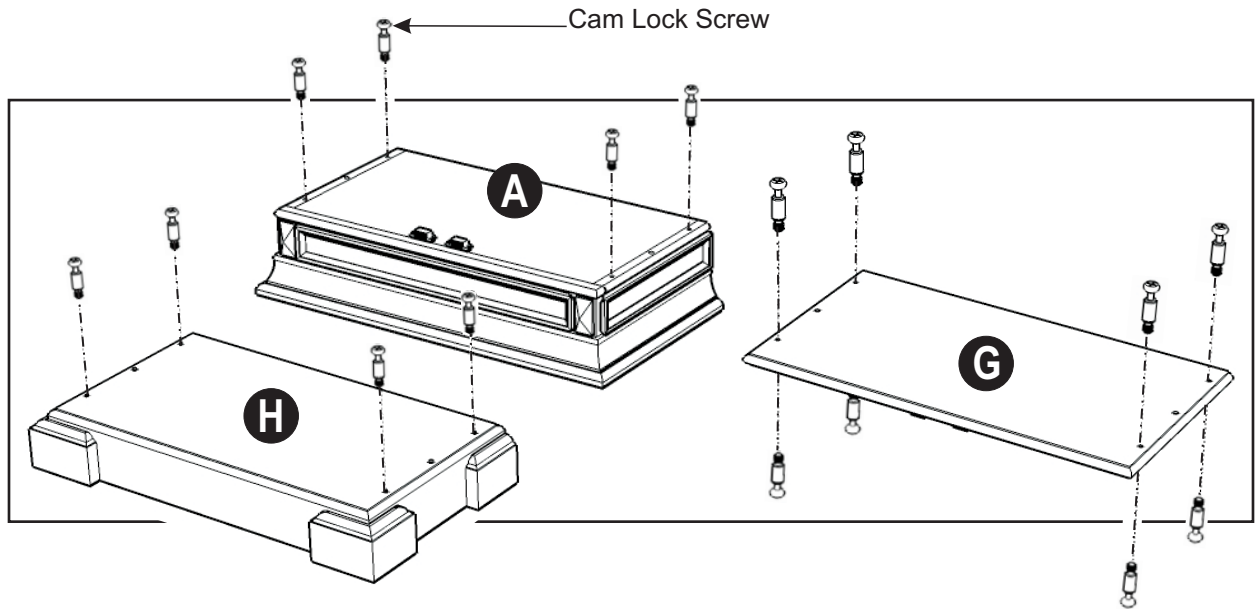

STEP 1

Put Cam Lock Screws into the pre-drilled holes of Top (A) Side Panels (B),(C) Base (G) and (H) and tighten.

STEP 2

Attach Back Stretcher (D) to Side Panel (B) using Cam Lock.

Attach Back Stretcher (E) to Back Stretcher (D).

Slide Back Panels (F) into place.

Attach Back Stretcher (D) to unit using Cam Lock.

Attach Side Panel (C) to unit using Cam Locks.

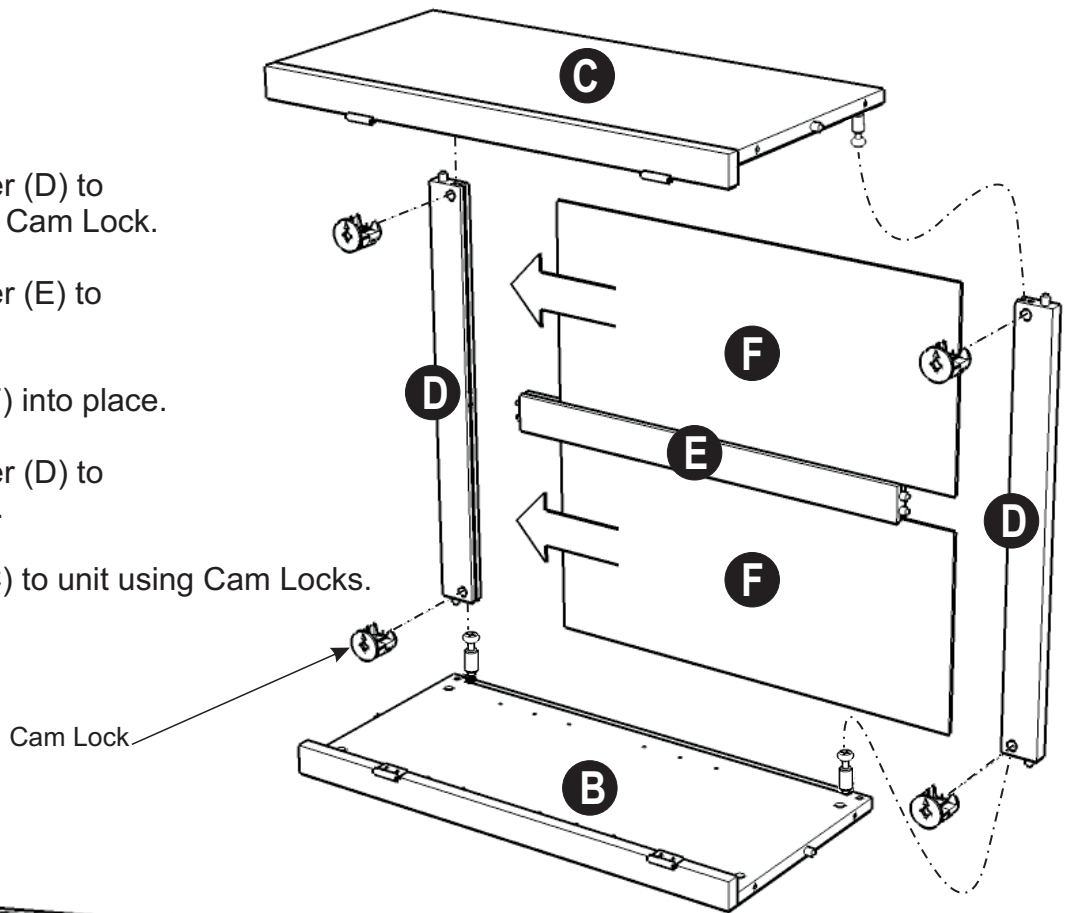

STEP 3

Attach unit from Step 2 to Base (H) using Cam Locks.

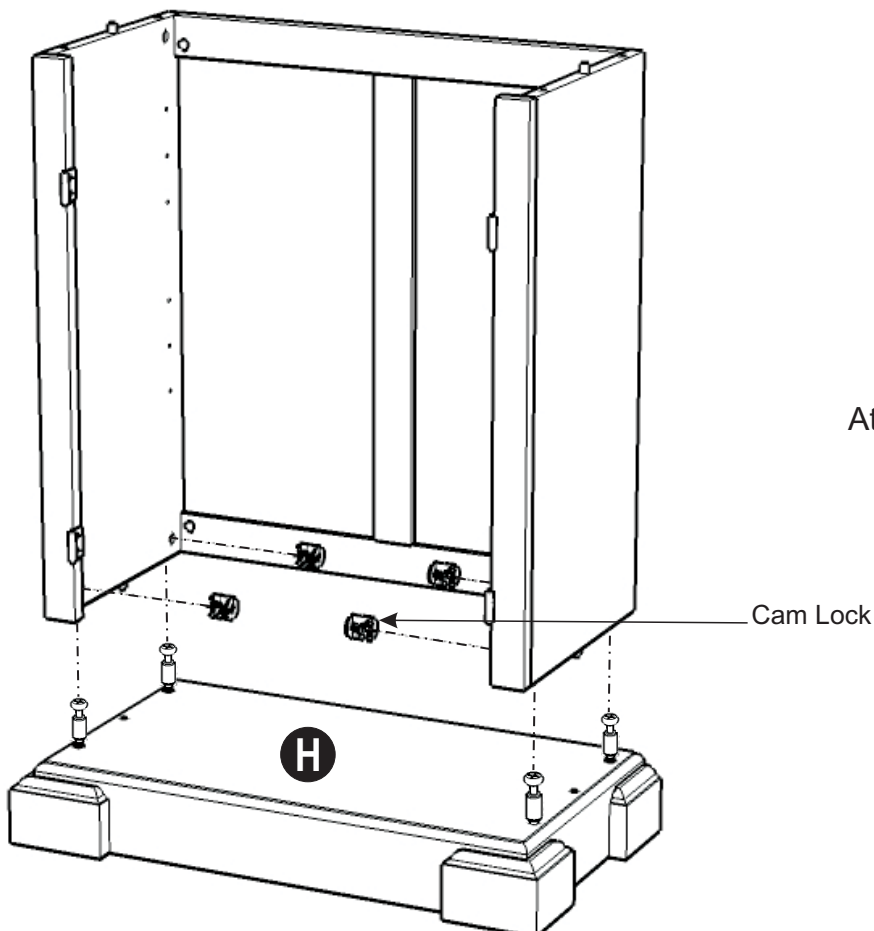

STEP 4

Attach Base (G) to unit using Cam Locks.

Attach Door (J) and (K) to unit by sliding the door lift hinges into the Side Panel lift hinges. (see Figure 1)

Cam Lock

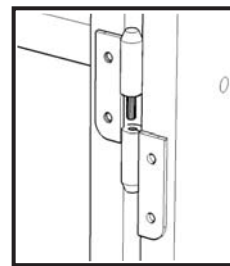
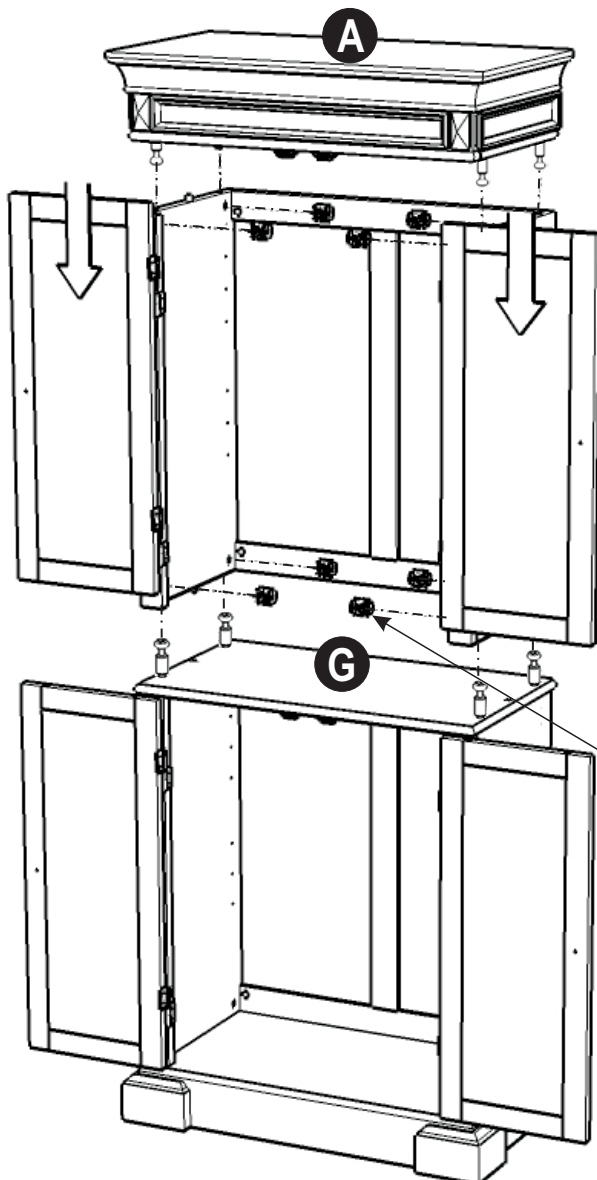
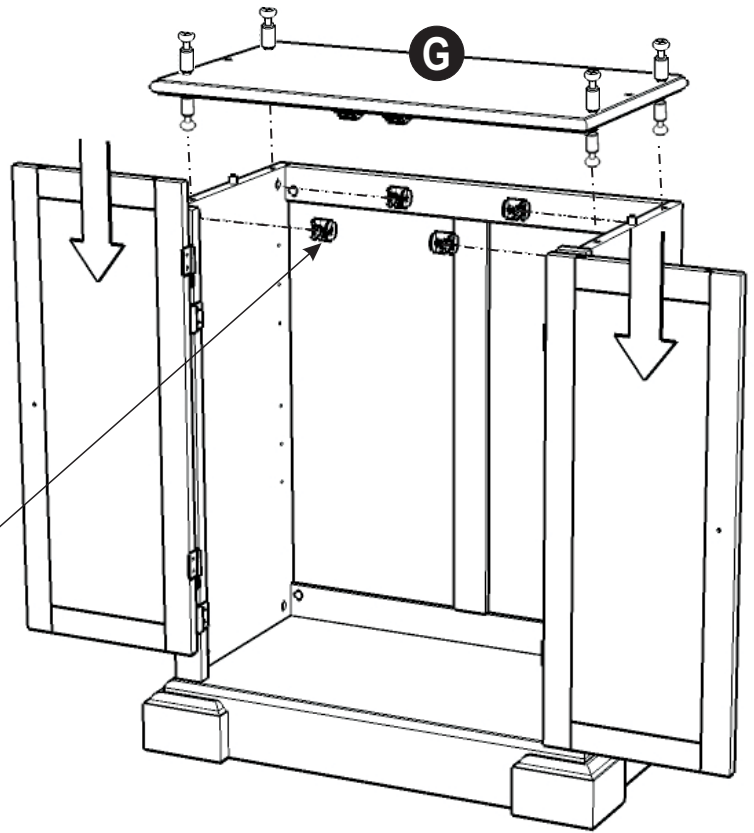

(Figure 1)

STEP 5

Attach unit from Step 2 to Base (G) using Cam Locks

Attach Door (J) and (K) to unit by sliding the door lift hinges into the Side Panel lift hinges. (see Figure 1)

Cam Lock

Attach Top (A) to unit using Cam Locks.

STEP 6

Attach the Door Pull Handle to Doors (J) and (K) using Machine Screws. (see Figure 2)

Insert the Adjustable Pins into both Side Panels at the desired level.

Place Shelves (I) into position.

To level the unit, adjust the adjustable levelers on the bottom of unit. (see Figure 3)

Insert 16X Wood Screws from the back of the unit and tighten. (see Figure 4)

Note: Unit must be level before tightening these screws.

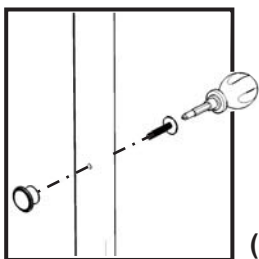

(Figure 2)

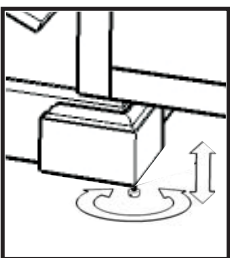

(Figure 3)

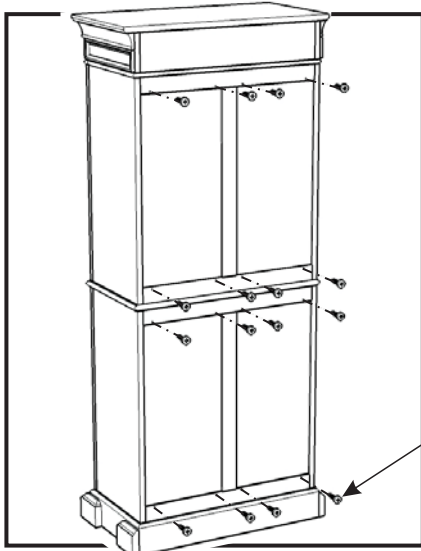

Wood Screw

(Figure 4)

