



Know what's below.  
Call before you dig.



# Decorative Driveway Gate Installation Manual

Installation Instructions for All Single and Dual Gate Kits

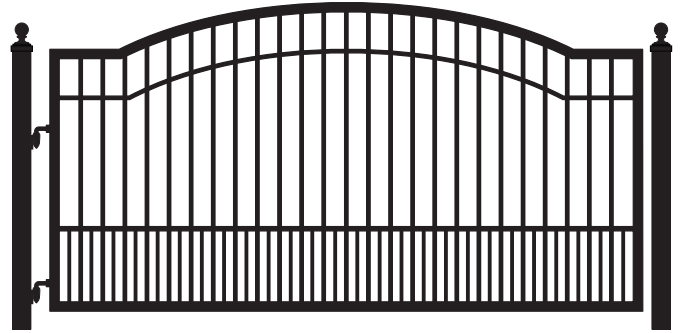
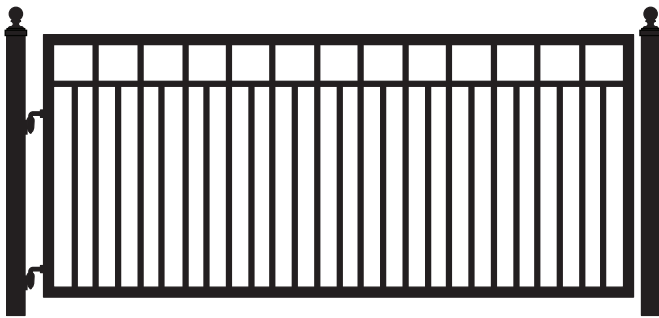

**IMPORTANT:** Before digging the holes for your installation, be sure to contact the appropriate utility companies and request that they mark the locations of all pipes, gas lines, electric, cable TV, etc. This will insure your safety and prevent you from damaging any of these utility lines.

[www.mightymulegates.com](http://www.mightymulegates.com)

# Parts List

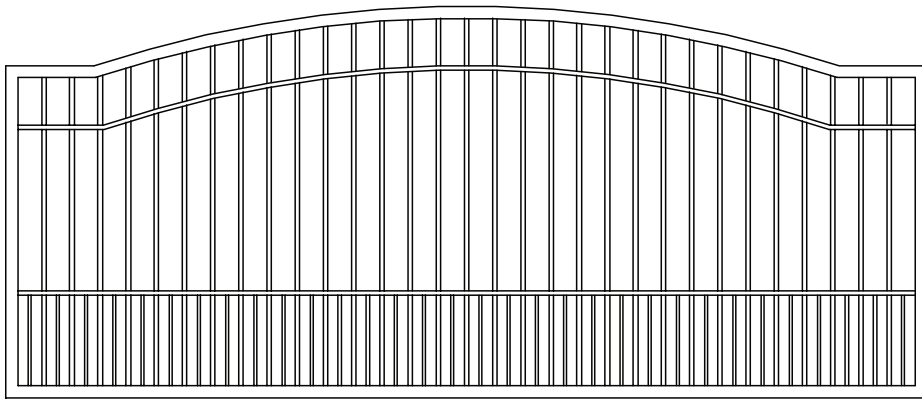

Gate Panel(s)

## Hinge Bolts

Single Gate (2)

Dual Gates (4)

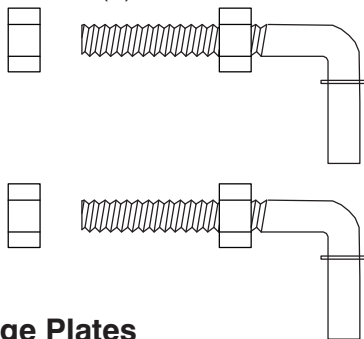

## Ball Caps (2)



## Gate Posts (2)

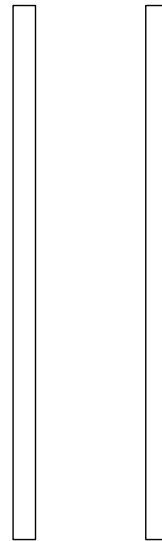

## Touch-up Paint Pen (1)



## Hinge Plates

(with ball bearings)

Single Gate (2)

Dual Gates (4)

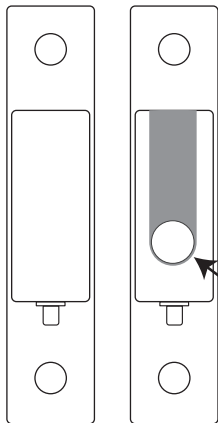

Ball Bearings  
(inside hinge barrels)

Single Gate (2)

Dual Gates (4)

## 5" Bolts

Single Gate (4)

Dual Gates (8)



## Flange Nuts

Single Gate (4)

Dual Gates (8)

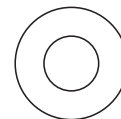

## Hinge Bolt Washers

Single Gate (4)

Dual Gates (8)

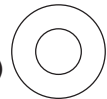

## Hinge Plate Washers

Single Gate (4)

Dual Gates (8)

# Tools Needed

Level

Mallet

Tape Measure (25')

Shovel

Line Level

Square

Concrete Mixer (recommended)

Water Bucket

Quick Set Concrete (400 lb. per post)

Wrenches

Wheelbarrow

Construction Adhesive

Stakes (6)

Post Hole Digger

Spray Paint for marking (optional)

String Line

Grease Gun

Extra Person to Help (recommended)

# Planning Your Gate Layout

**IMPORTANT!** When selecting the location for your gate, consider the following:

1. Provide room for a vehicle to leave the roadway while waiting for the gate to open.
2. Leave enough room in front and behind the gate to allow it to swing open without hitting a vehicle.

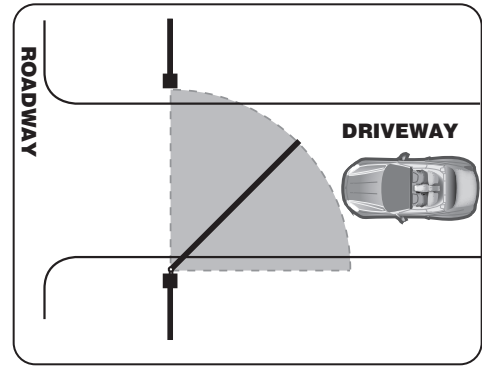
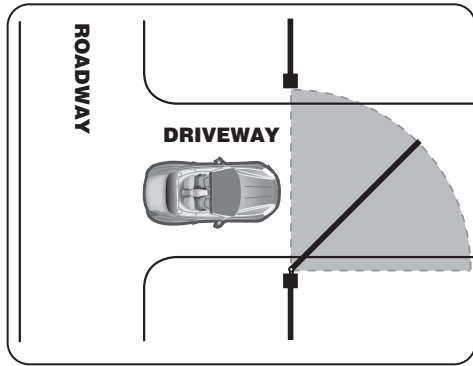

3. Be sure that when the gate is completely open, it will clear the drive path. This is especially important when installing on a curved driveway; improper installation can prevent the gate from clearing the driveway when the gate is fully open, causing a vehicle to hit the gate.

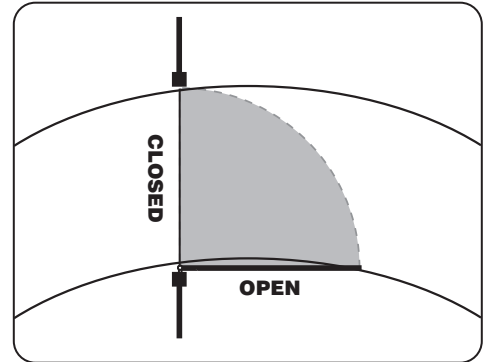
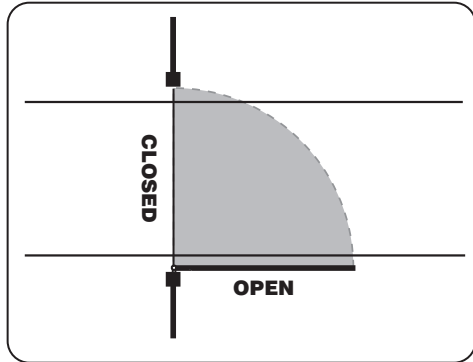

4. Use a string line and line level to determine if there is uneven ground or driveway slope that would prevent the gate from reaching its fully open position. The string line and line level will help you to compensate for uneven ground/slope when installing the gate posts.

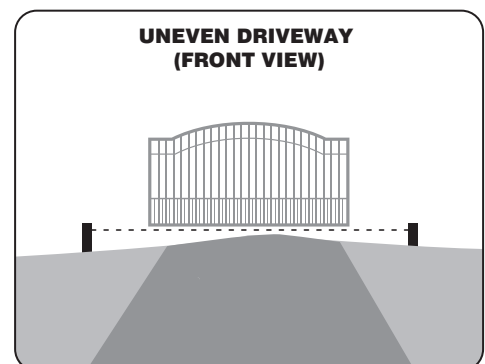
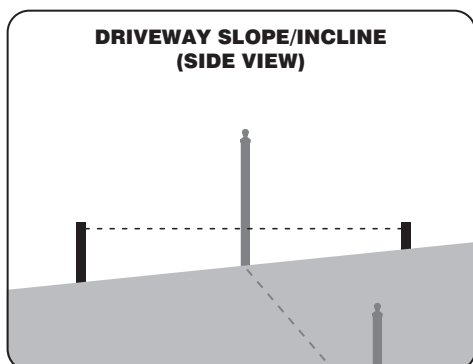

5. The most common installation has the gate opening *into* the property (Pull-to-Open). In cases where the driveway has an incline toward the property, you may have to install the gate so that it opens *away* from the property (Push-to-Open)

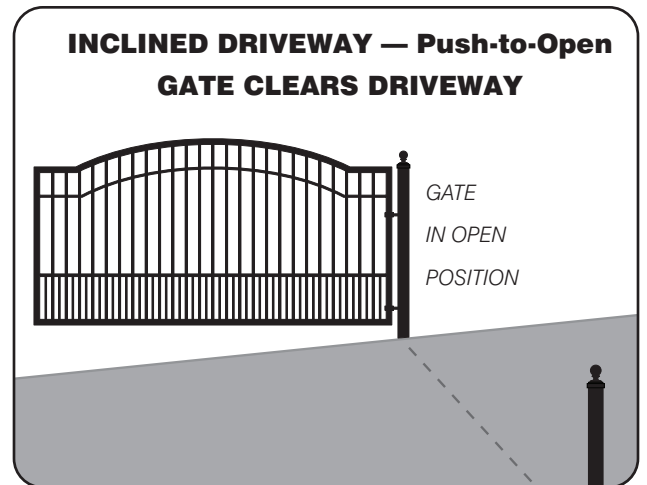
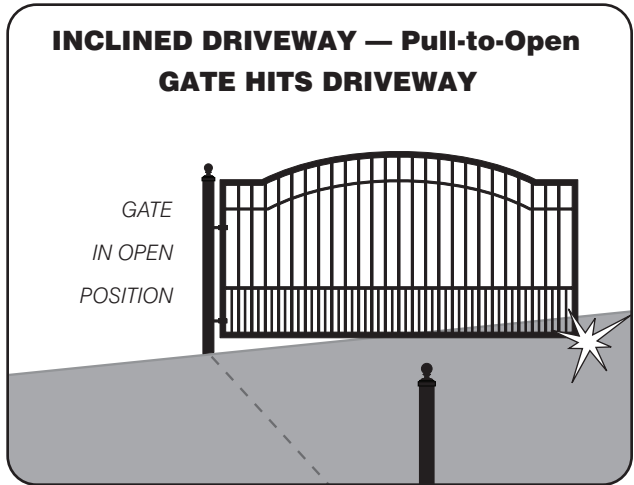

6. Because the hinge post carries the weight of the gate, installations on uneven/sloped driveways require that the hinge post be on the high side of the slope. This will insure that the post can be buried to the minimum required depth for stability.

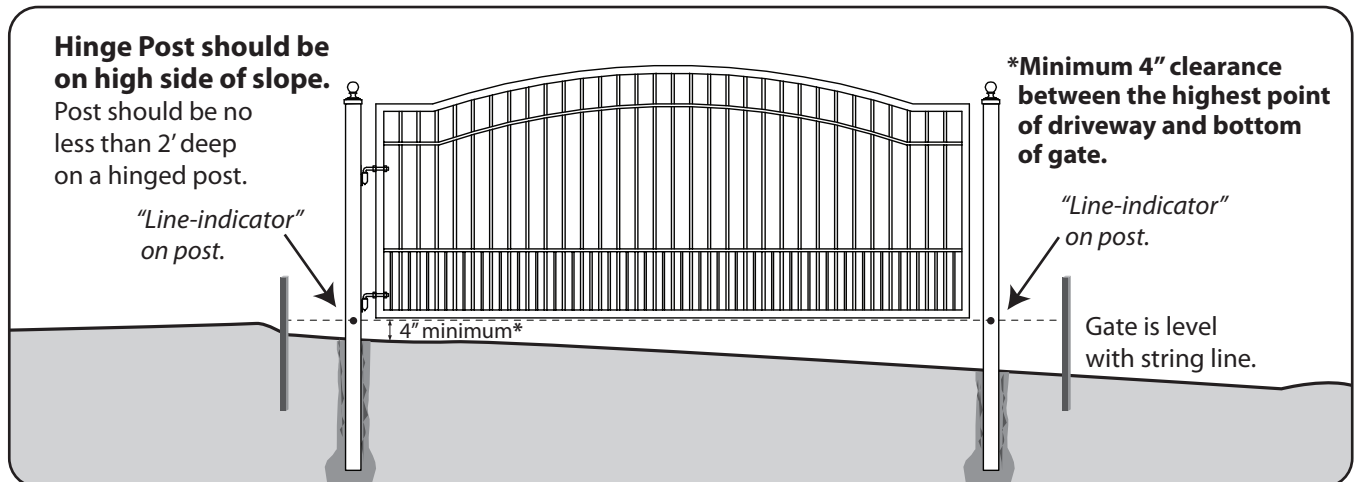

## Determining Position for Gate Post Installation

1. Refer to measurements on the Installation Manual Cover (Gate Specs) for setting posts.
2. Before setting posts in concrete, measure gate panels to insure they match Installation Manual Cover (Gate Specs).
3. Be sure to allow for 4" clearance from the bottom of the gate to the highest point on driveway or curb.

### Setting Stakes and Level Lines (Overhead View)

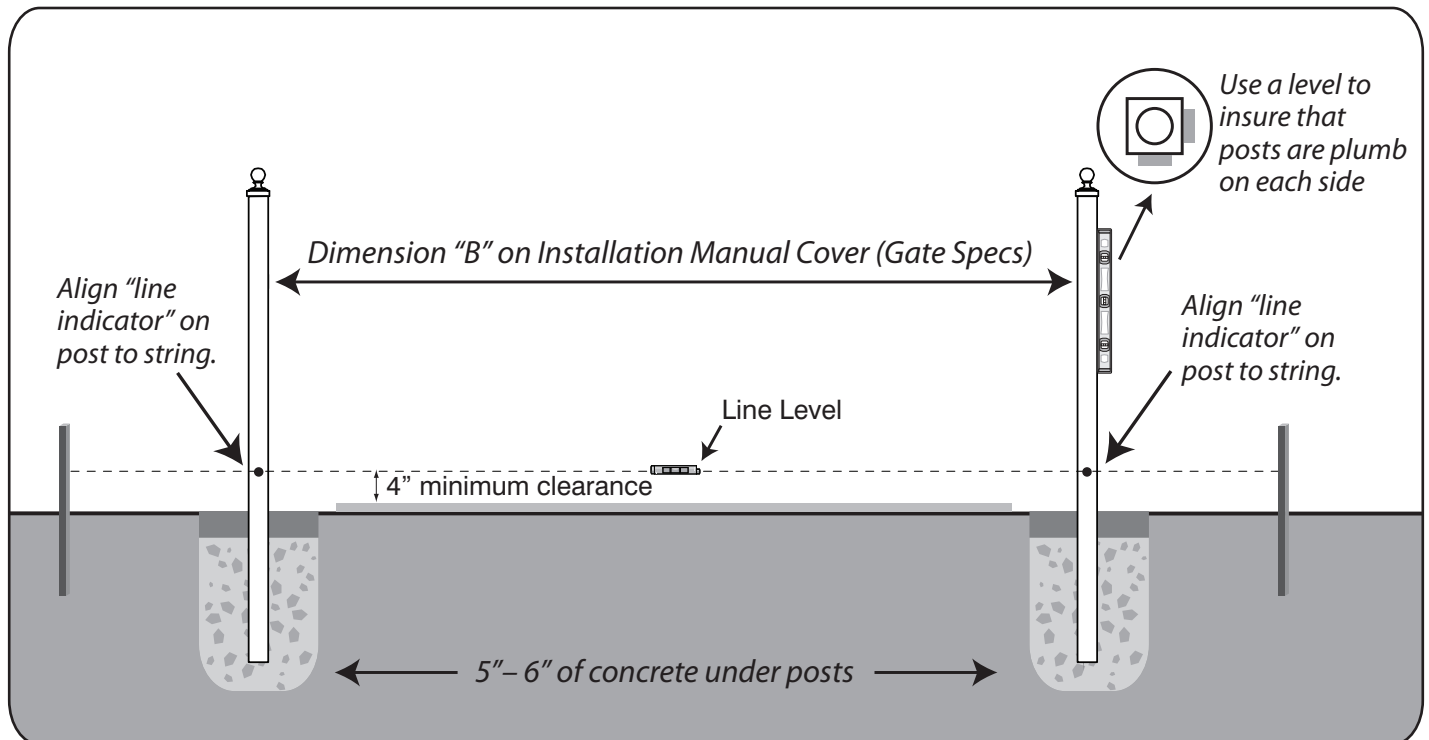
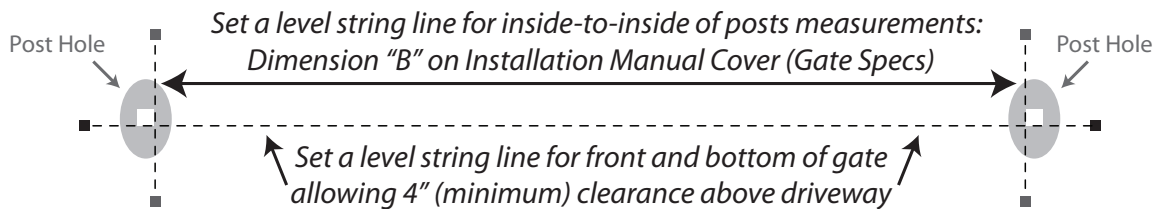

# Setting The Posts

1. Dig the holes approximately 12" wide, 20" long (the elongated side should run parallel to the driveway). Do not make holes perfectly round to help prevent posts from twisting after time. Depth of the hole will depend on whether the ground is level or sloped. If ground is flat, holes should be approximately 42" deep.
2. Mix the concrete according to the instructions on the concrete bag. A stiff mix is necessary for post to stand by itself while concrete sets. If mix is too liquid, posts will need to be held in place until the concrete sets.
3. Start with a base of concrete approximately 5-6 inches deep before putting the post in the hole.
4. Next, place the post in the hole that is on the highest side of the driveway (if sloped). The level indicator on the post must be aligned with the string line (at least 4 inches above ground).
5. Fill the remainder of the hole by alternating the concrete around the four sides of the post so it stays centered.
6. Leave a gap (approximately 5") between the ground level and concrete. After the concrete dries you can fill the rest in with dirt so that grass can grow over the concrete.
7. Repeat Steps 3 – 6 for the second post.

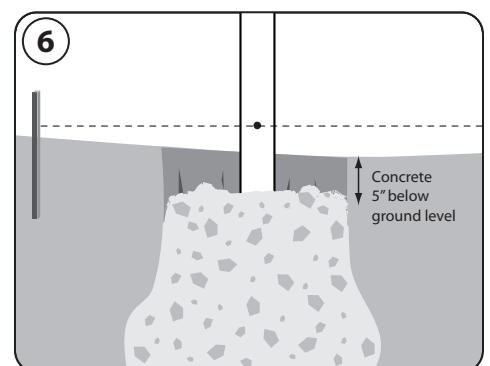
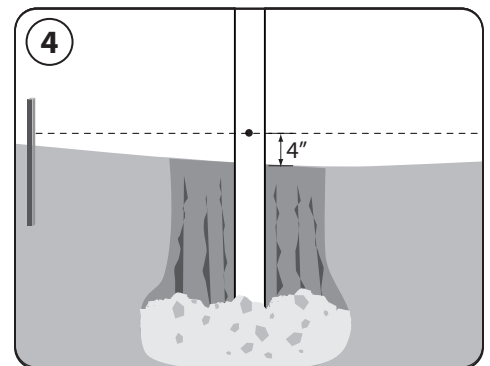
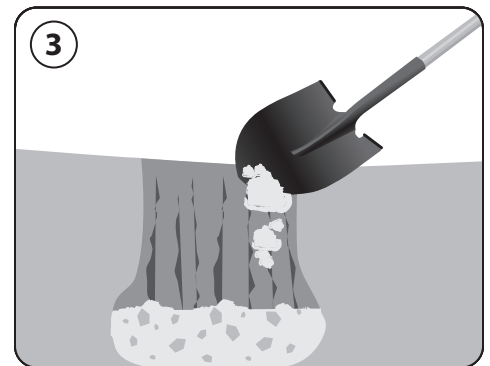

## IMPORTANT:

- (A) Check to be sure that the posts are plumb by checking each side with a standard level.
- (B) Use a measuring tape to insure that the space between the insides of posts is equal to "Dimension B" on the Cover Sheet (Spec Sheet) of this Installation Manual.
- (C) Insure that the level indicators for each post align with the string line.
- (D) Make adjustments as necessary.

# Attaching the Hinge Plates and Hanging the Gate

## **IMPORTANT: Allow concrete to set for 24 hours before starting next step!**

Before continuing with the next steps for your gate installation, allow the concrete to set for at least 24 hours (or according to the concrete manufacturer's recommendations). This will insure that your posts are installed in a solid concrete base and prevent any movement of the posts that could jeopardize the installation or cause functional/safety issues.

1. Secure the hinge plates to the gate post with the bolts, washers, and nuts included in the hardware bag. Tighten nuts by hand.
2. Secure hinge bolts to the gate with the washers and nuts included. Tighten nuts by hand. **TIP:** A slightly loose hinge bolt provides ease and flexibility when dropping the hinge bolt into the hinge barrel.
3. Make sure ball bearings are inserted into all hinge barrels.
4. Lower the gate hinges bolts into the hinge barrels. Make sure the hinge bolts fit all the way into the hinge barrels.
5. Adjust gate level by tightening and loosening the hinge bolt nuts.
6. Check to be sure your gate is level before tightening all nuts with a wrench. If installing a dual gate, be sure that both gate panels are level with one another.
7. Tighten ALL nuts with a wrench. Install ball caps on gate posts and secure with construction adhesive.
8. Grease the hinges (see instructions on Page 8).

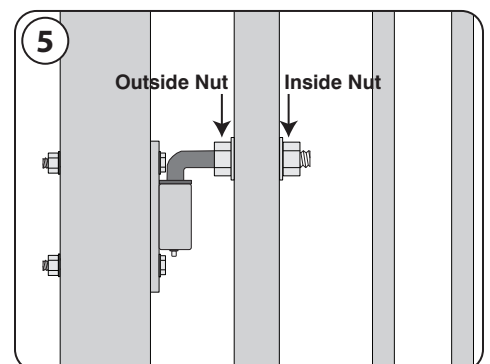
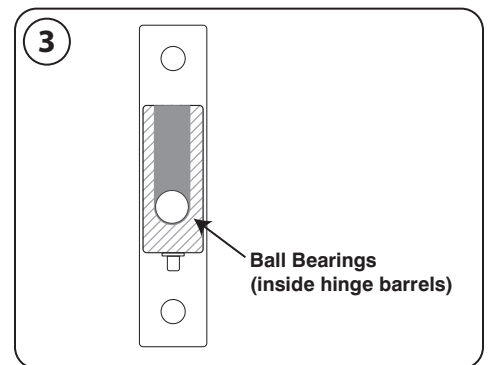
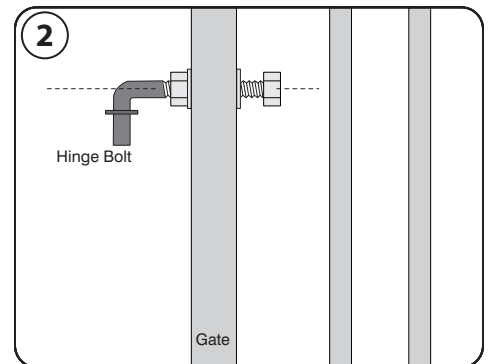
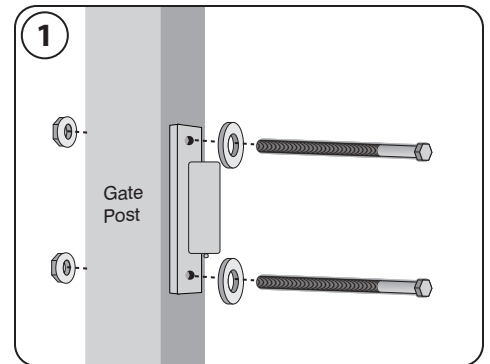

## Maintenance and Troubleshooting

If your Mighty Mule EZ Gate is not operating properly, please follow the recommended solutions below. If after trying the recommended solutions your Mighty Mule EZ Gate is still not operating properly, contact Technical Service for assistance.

- **If your gate is not level:** Adjust the hinge bolts to lift or lower the top or bottom of the gate panel.
- **If minor rust or weeping develops:** Use the black touch up paint included with your gate to touch up spots. If the rust is more serious other products may be required to remove and inhibit the rust.
- **If your gate is squeaking:** Lubricate hinges. For maintenance lubricate the grease fittings once per year.

**IMPORTANT:** Lubricate gate hinges once a year for smooth operation. Using a grease gun, place nozzle over the gate hinge grease fitting and squeeze the gun handle to insert the grease into the hinge barrel.

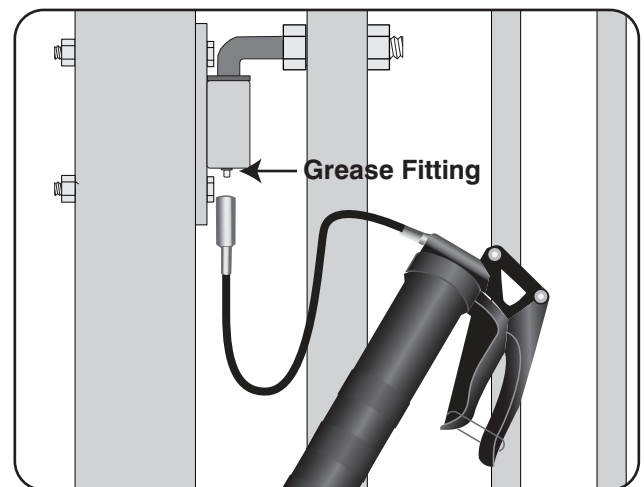

The Mighty Mule Service Department is open Monday – Friday  
8:00 A.M. – 7:00 P.M. (Eastern Time)  
**1-800-543-1236 • FAX 850-575-8950 • [www.mightymulegates.com](http://www.mightymulegates.com)**  
Visit <http://support.gtoinc.com/support/troubleshooter.aspx> to open a Tech Ticket.

Gates That Open, LLC  
3121 Hartsfield Road • Tallahassee, Florida, USA 32303  
GTO Sales: 1-800-543-GATE (4283) or (850) 575-0176 • Fax (850) 575-8912  
GTO Technical Service: 1-800-543-1236 or (850) 575-4144 • Fax (850) 575-8950