

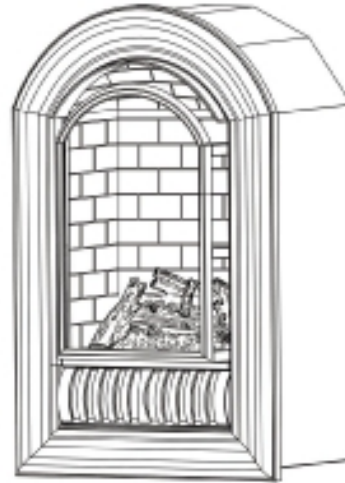

Vent – Free Arched Fireplace
Model: ANI & ALI



⚠ CAUTION – FOR YOUR SAFETY

⚠ WARNING: IF THE INFORMATION IN THIS MANUAL IS NOT FOLLOWED EXACTLY, A FIRE MAY RESULT CAUSING PROPERTY DAMAGE, PERSONAL INJURY OR LOSS OF LIFE.

- Do not store or use gasoline or other flammable vapors and liquids in vicinity of this or any other appliance.

WHAT TO DO IF YOU SMELL GAS

- Do not try to light any appliance.
 - Do not touch any electrical switch; do not use any phone in your building.
 - Immediately call your gas supplier from a neighbor's phone. Follow the gas supplier's instructions.
 - If you cannot reach your gas supplier, call the fire department.
- Installation and service must be performed by a qualified installer, service agency or the gas supplier.

This is an unvented gas-fired heater. It uses air (oxygen) from the room in which it is installed. Provisions for adequate combustion and ventilation air must be provided.

Refer to *Air For Combustion and Ventilation* section on page 6 of this manual.

INSTALLER: DO NOT DISCARD THIS MANUAL – LEAVE WITH HOMEOWNERS FOR FUTURE REFERENCE

This appliance may be installed in an aftermarket, permanently located, manufactured (mobile) home, where not prohibited by local codes.

This appliance is only for use with the type of gas indicated on the rating plate. This appliance is not convertible for use with other gases.



Questions about installation, operation, or troubleshooting? Before returning to your retailer, call our customer service department toll-free at 1-877-886-5989

HS-AN/LI 200MV-509-0708

TABLE OF CONTENTS

| | |
|---|----|
| Important Safety Information..... | 3 |
| Air for Combustion and Ventilation..... | 6 |
| Installation | 8 |
| Operating | 17 |
| Cleaning & Maintenance | 20 |
| Troubleshooting | 21 |
| Replacement Parts..... | 23 |



WARNING: READ THE INSTALLATION & OPERATION INSTRUCTIONS BEFORE USING THIS APPLIANCE

IMPORTANT: Read instructions and warnings carefully before starting installation. Failure to follow these instructions may result in a possible fire hazard and will void the warranty.

PRODUCT SPECIFICATIONS

| ITEM NO. | ANI | ALI |
|---------------------------|-------------------------|------------------|
| Input Rating | 20,000 BTU/Hr | 20,000 BTU/Hr |
| Gas Type | Natural | LP/Propane |
| Ignition | Piezo /Automatic | Piezo /Automatic |
| Manifold Pressure | 3.5"W.C. | 10"W.C. |
| Inlet Gas Pressure | | |
| Maximum | 10.5" | 14" |
| Minimum | 5" | 11 " |
| Dimensions, inches(HxWxD) | | |
| Heater | 34 1/2" x 21 1/2" x 15" | |
| Carton | 38" x 24" x 17 1/10" | |
| Weight, lbs | | |
| Stove | 77.2 | |
| Shipping | 94 | |

*For purposes of input adjustment

IMPORTANT SAFETY INFORMATION



IMPORTANT:

Read this owner's manual carefully and completely before trying to assemble, operate, or service this heater. Improper use of this heater can cause serious injury or death from burns, fire, explosion, electrical shock, and carbon monoxide poisoning.

Installation and service must be performed by a qualified installer, service agency, or local gas supplier.



WARNING: Do not store or use gasoline or other flammable vapors or liquids in the vicinity of this or any other appliance.

CARBON MONOXIDE POISONING: Early signs of carbon monoxide poisoning resemble the flu with headaches, dizziness, or nausea. If you have these signs, the heater may not be working properly. Get fresh air immediately! Have heater serviced. Some people are more affected by carbon monoxide than others. These include pregnant women, people with heart, or lung disease, anemia, those under the influence of alcohol, and those at high altitudes.

NATURAL AND PROPANE/LP GAS: Natural and Propane/LP gases are odorless. An odor-making agent is added to the gas. The odor helps you detect a gas leak. However, the odor added to the gas can fade. Gas may be present even though no odor exists. Make certain you read and understand all warnings. Keep this manual for reference. It is your guide to safe and proper operation of this heater.



WARNING: Any change to this fireplace or its controls can be dangerous.



WARNING: Do not allow fans to blow directly into the heater. Avoid any drafts that alter burner flame patterns including ceiling fans. Altered burner patterns can cause sooting.

Do not use a blower insert, heat exchanger insert, or other accessory not approved for use with this heater.

Due to high temperatures, the appliance should be located out of traffic and away from furniture and draperies.

Do not place clothing or other flammable material on or near the appliance. Never place any objects in the fireplace. Heater becomes very hot when running fireplace. Keep children and adults away from hot surfaces to avoid burns or clothing ignition. Fireplace will remain hot for a time after shutdown. Allow surfaces to cool before touching. Carefully supervise young children when they are in the room with fireplace.

You must operate this heater with the heater glass screen in place.

Keep the appliance area clear and free from combustible materials, gasoline, and other flammable vapors and liquids.

IMPORTANT SAFETY INFORMATION (CONTINUED)

This appliance is for use with only the type of gas indicated on the rating plate. This appliance is not convertible for use with other gases.

1. Do not place Propane/LP supply tank(s) inside any structure. Store Propane/LP supply tank(s) outdoors.
2. This heater shall not be installed in a bedroom or bathroom.
3. Do not use this heater as a wood-burning heater. Use only the logs provided with the heater.
4. Do not add extra logs or ornaments such as pine cones, vermiculite, or rock wool. Using these added items can cause sooting. Do not add lava rock around base. Rock and debris could fall into the control area of heater. After servicing, always replace glass screen before operating heater.
5. Make sure the heater glass screen is in place before running the heater.
6. This heater is designed to be smokeless. If logs ever appear to smoke, turn off heater and call a qualified service person. **Note:** During initial operation, slight smoking could occur due to log curing and the heater burning manufacturing residues.
7. To prevent the creation of soot, follow the instructions in *Cleaning and Maintenance* (page 19).
8. Before using furniture polish, wax, carpet cleaner, or similar products, turn heater off. If heated, the vapors from these products may create a white powder residue within burner box or on adjacent walls or furniture.
9. This heater needs fresh air ventilation to run properly. This heater has an Oxygen Depletion Sensing (ODS) safety shutoff system. The ODS shuts down the heater if not enough fresh air is available. See *Air for Combustion and Ventilation*, pages 6 through 8. If heater keeps shutting off, see *Troubleshooting*, pages 21 through 23.
10. Do not run heater:
 - Where flammable liquids or vapors are used or stored.
 - Under dusty conditions.
11. Do not use this heater to cook food or burn paper or other objects.
12. Do not use this heater if any part has been under water. Immediately call a qualified service technician to inspect the room heater .
13. Turnoff and unplug heater and let cool before servicing. Only a qualified service person should service and repair heater.
14. Operating heater above elevations of 4,500 feet could cause pilot outage.
15. Do not operate heater if any log is broken. Do not operate heater if any log is chipped (dime-sized or larger).
16. To prevent performance problems, do not use a propane/LP fuel tank of less than 100 lbs capacity.

QUALIFIED INSTALLING AGENCY

Installation and replacement of gas piping, gas utilization equipment or accessories and repair and servicing of equipment should be performed only by a qualified agency. The term "qualified agency" means any individual, firm, corporation, or company that either in person or through a representative is engaged in and is responsible for:

- a) The installation, testing, or replacements of gas piping or
- b) The connection, installation, testing, repair, or servicing of equipment; that is experienced in such work; that is familiar with all precautions required; and that has complied with all the requirements of the authority having jurisdiction.

PRODUCT FEATURES

Safety Pilot

This heater has a pilot with an Oxygen Depletion Sensing (ODS) safety shutoff system. The ODS/pilot is a required feature for vent-free room heaters. The ODS/pilot shuts off the heater if there is not enough fresh air.

Piezo Ignitor System

This heater is equipped with an electronic piezo ignitor. This system requires AAA batteries (provided).

Millivolt Gas Control

Allows heater to operate by a wall thermostat or remote control (sold separately) .

LOCAL CODES

Install and use heater with care. Follow all local codes. In the absence of local Codes use the latest edition of the national fuel gas code, ANSIZ 223.1, also known as NFPA54*.

*Available from:

American National Standards Institute, Inc.
1430 Broadway
New York, NY 10018

National Fire Protection Association, Inc.
1Batterymarch Park
Quincy, MA 02269-9101

This heater is designed for vent-free operation. State and local codes in some areas prohibit the use of vent-free heaters.

State of Massachusetts: The installation must be made by a licensed plumber or gas fitter in the Commonwealth of Massachusetts. Sellers of unvented propane or natural gas-fired supplemental room heaters shall provide to each purchaser a copy of 527 CMR 30 upon sale of the unit.

In the State of Massachusetts, unvented propane or natural gas-fired space heaters shall be prohibited in bedrooms and bathrooms.

In the State of Massachusetts the gas cock must be a T-handle type. The State of Massachusetts requires that a flexible appliance connector cannot exceed three feet in length.

UNPACKING

1. Remove top inner pack
2. Tilt carton so that fireplace is upright.
3. Remove protective side packaging.
4. Slide fireplace out of carton.
5. Remove protective plastic wrap.
6. Hold the panel lift and pull forward.
7. Remove log set by cutting plastic ties.
8. Carefully un-wrap log.
9. Check for any shipping damage. If fireplace or log is damaged, promptly inform your dealer where you bought the fireplace.

PRODUCT IDENTIFICATION

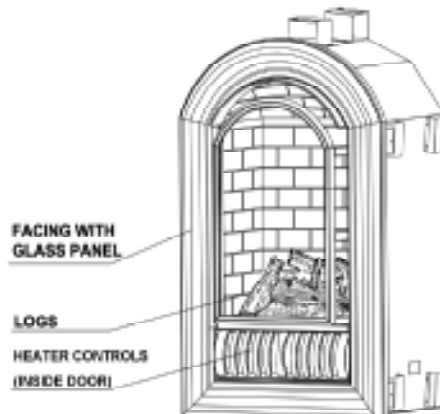

Figure 1

WATER VAPOR: A BY-PRODUCT OF UNVENTED ROOM HEATERS

Water vapor is a by-product of gas combustion. An unvented room heater produces approximately one (1) ounce (30ml) of water for every 1,000 BTUs (.3KW) of gas input per hour.

An unvented room heater is recommended as a supplemental heater (one room) rather than a primary heat source (an entire house). In most supplemental heat applications, the water vapor does not create a problem. In most applications, the water vapor enhances the low humidity atmosphere experienced during cold weather. The following steps will help ensure that water vapor does not become a problem.

1. Be sure the heater is sized properly for the application, including adequate combustion air and circulation air.
2. If high humidity is experienced, a dehumidifier may be used to help lower the water vapor content of the air.
3. Do not use an unvented room heater as the primary heat source.

AIR FOR COMBUSTION AND VENTILATION



WARNING: This heater shall not be installed in a confined space or unusually tight construction unless provisions are provided for adequate combustion and ventilation air. Read the following instructions to insure proper fresh air for this and other fuel-burning appliances in your home:

Producing Adequate Ventilation

The following are excerpts from National Fuel Gas Code, NFPA 54/ANSI Z 223.1, Section 5.3, Air for Combustion and Ventilation.

All spaces in homes fall into one of the three following ventilation classifications:

1. Unusually Tight Construction
2. Unconfined Space
3. Confined Space

The information on pages 6 through 8 will help you classify your space and provide adequate ventilation.

Confined and Unconfined Space

The National Fuel Gas Code, ANS Z223.1 defines a confined space as a space whose volume is less than 50 cubic feet per 1,000 Btu per hour (4.8 m³ per kw) of the aggregate input rating of all appliances installed in that space and an unconfined space as a space whose volume is not less than 50 cubic feet per 1,000 Btu per hour (4.8 m³ per kw) of the aggregate input rating of all appliances installed in that space. Rooms connected directly with the space in which the appliances are installed*, through openings not furnished with doors, are considered a part of the unconfined space.

This heater shall not be installed in a confined space or unusually tight construction unless provisions are provided for adequate combustion and ventilation.

* Adjoining rooms are connecting only if there are doorless passageways or ventilation grills between them.

Unusually Tight Construction

The air that leaks around doors and windows may provide enough fresh air for combustion and ventilation. However, in buildings of unusually tight construction, you must provide additional fresh air.

Unusually tight construction is defined as construction where:

- a) walls and ceilings exposed to the outside atmosphere have a continuous water vapor retarder with a rating of one perm (6x10⁻¹¹kg per pa-sec-m²) or less with openings gasketed or sealed and
- b) weather stripping has been added on windows that can be opened and doors and
- c) caulking or sealants are applied to areas such as joints around window and door frames, between sole plates and floors, between wall-ceiling joints, between wall panels, at penetrations for plumbing, electrical, and gas lines, and at other openings.

If your home meets all of the three criteria above, you must provide additional fresh air. See Ventilation Air From Outdoors (page 8). If your home does not meet all of the three criteria above, proceed to "Determining Fresh-Air Flow For Heater Location" (below).

DETERMINING FRESH-AIR FLOW FOR HEATER LOCATION

Determining if You Have a Confined or Unconfined Space

Use this worksheet to determine if you have a confined or unconfined space.

Space: Includes the room in which you will install heater plus any adjoining rooms with doorless passageways or ventilation grills between the rooms.

1. Determine the volume of the space _____

Length×Width×Height= _____ cu.ft. (volume of space)

Example: Space size 20ft. (length) × 16ft. (width) × 8ft. (ceiling height) = 2560cu. ft. (volume of space) If additional ventilation to adjoining room is supplied with grills or openings, add the volume of these rooms to the total volume of the space.

2. Divide the space volume by 50 cubic feet to determine the maximum Btu/Hr the space can support.

_____ (volume of space) ÷ 50 cu. ft. = (Maximum Btu/Hr the space can support)

Example: 2560 cu. ft. (volume of space) ÷ 50 cu.ft.=51.2 or 51,200(maximum Btu/Hr the space can support)

3. Add the Btu/Hr of all fuel burning appliances in the space.

| | | | | |
|-------------------------|--------------|------------------|----------|--------|
| Vent-free heater | _____ Btu/Hr | | | |
| Gas water heater* | _____ Btu/Hr | | | |
| Gas furnace | _____ Btu/Hr | Example: | | |
| Vented gas heater | _____ Btu/Hr | Gas water heater | 30,000 | Btu/Hr |
| Gas heater logs | _____ Btu/Hr | Vent-free heater | + 26,000 | Btu/Hr |
| Other gas appliances* + | _____ Btu/Hr | Total | = 56,000 | Btu/Hr |
| Total = | _____ Btu/Hr | | | |

*Do not include direct-vent gas appliances. Direct-vent draws combustion air from the outdoors and vents to the outdoors.

4. Compare the maximum Btu/Hr the space can support with the actual amount of Btu/Hr used.

_____ Btu/Hr (maximum the space can support)

_____ Btu/Hr (actual amount of Btu/Hr used)

Example: 51,200 Btu/Hr (maximum the space can support)

56,000 Btu/Hr (actual amount of Btu/Hr used)

The space in the above example is a confined space because the actual Btu/Hr used is more than the maximum Btu/Hr the space can support. You must provide additional fresh air. Your options are as follows:

- a) Rework worksheet, adding the space of an adjoining room. If the extra space provides an unconfined space, remove door to adjoining room or add ventilation grills between rooms. See "Ventilation Air from Outdoors," page 8.
- b) Vent room directly to the outdoors. See "Ventilation Air from Outdoors," page 8.
- c) Install a lower Btu/Hr heater, if lower Btu/Hr size makes room unconfined. If the actual Btu/Hr used is less than the maximum Btu/Hr the space can support, the space is an unconfined space. You will need no additional fresh air ventilation.

WARNING: If the area in which the heater may be operated is smaller than that defined as an unconfined Space or if the building is of unusually tight construction, provide adequate combustion and ventilation air by one of the methods described in the National Fuel Gas Code, ANSI Z223.1, Section 5.3 or applicable local codes.

Ventilation Air From Inside Building

This fresh air would come from adjoining unconfined space. When ventilating to an adjoining unconfined space, you must provide two permanent openings: one within 12 inches of the wall connecting the two spaces (see options 1 and 2, Figure 2). You can also remove door into adjoining room (see option 3, Figure 2). Follow the National Fuel Gas Code NFPA 54/ANS Z223.1. Section 5.3, *Air for Combustion and Ventilation* for required size of ventilation grills or ducts.

Ventilation Air From Outdoors

Provide extra fresh air by using ventilation grills or duct. You must provide two permanent openings: one within 12 inches of the ceiling and one within 12 inches of the floor. Connect these items directly to the outdoors or spaces open to the outdoors. These spaces include attics and crawl spaces. Follow the National Fuel Gas Code NFPA 54/ANS Z223.1, Section 5.3. Air for Combustion and Ventilation for required size of ventilation grills or ducts.

IMPORTANT: Do not provide openings for inlet or outlet air into attic if attic has a thermostat-controlled power vent. Heated air entering the attic will activate the power vent. Rework worksheet, adding the space of the adjoining unconfined space. The combined spaces must have enough fresh air to supply all appliances in both spaces.

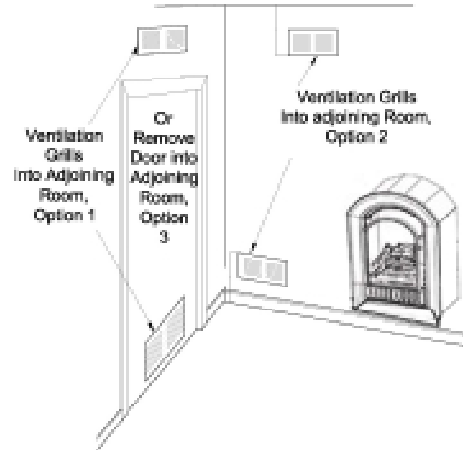

Figure 2 -Ventilation Air from Inside Building

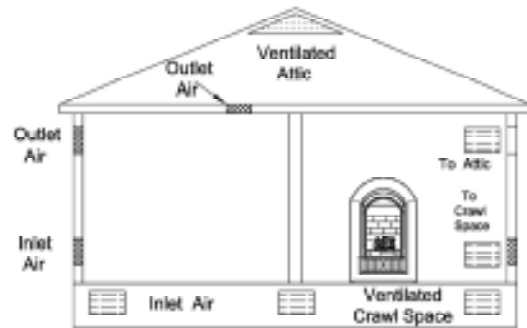

Figure3 -Ventilation Air from Outdoors

INSTALLATION

NOTICE: This heater is intended for use as supplemental heat. Use this heater along with your primary heating system. Do not install this heater as your primary heat source. If you have a central heating system, you may run your system's circulating blower while using heater. This will help circulate the heat throughout the house.

WARNING: A qualified technician person must install heater. Follow all local codes.

- WARNING:** Never install the heater
- In a bedroom or bathroom
 - In a recreational vehicle
 - Where curtains, furniture, clothing, or other flammable objects are less than 42 inches from the front, top or sides of the heater.
 - In high traffic areas
 - In wind or drafty areas

WARNING: Maintain the minimum clearances. If you can, provide greater clearances from floor, ceiling, and adjoining side and back walls.

CAUTION: This heater creates warm air currents. These currents move heat to wall surfaces next to heater. Installing heater next to vinyl or cloth wall coverings or operating heater where impurities (such as tobacco smoke, aromatic candles, cleaning fluids, oil or kerosene lamps, etc.) in the air exist may discolor walls.

INSTALLATION Continued

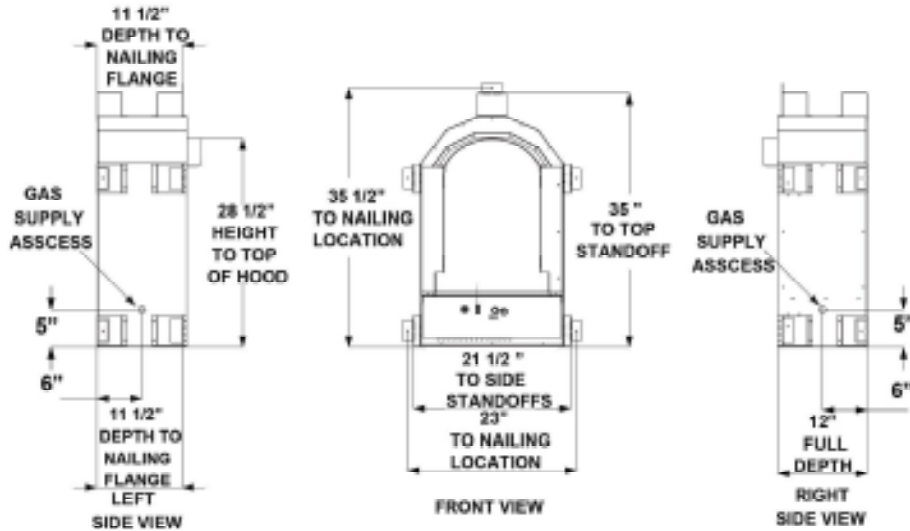

Figure 4 – Fireplace Dimensions

IMPORTANT: Vent-free heaters add moisture to the air. Although this is beneficial, installing heater in rooms without enough ventilation air may cause mildew to form from too much moisture. See *Air for Combustion and Ventilation*, pages 6 through 8.

CHECK GAS TYPE

Use only the type of gas indicated on the plate. If your gas supply can not meet that requirement, do not install heater.

CLEARANCES TO COMBUSTIBLES

Carefully follow the instructions below.

IMPORTANT: You must maintain minimum wall and ceiling clearances during installation. The minimum clearances are shown in Figure 5. Measure from outermost point of fireplace.

Minimum Wall and Ceiling Clearances (see Figure 5)

- Clearances from outermost point of fireplace to any combustible
- side wall should not be less than 8 inches.
- Clearances from the fireplace to the ceiling should not be less than 32 inches.

NOTE: Surface temperatures of adjacent walls and mantels become hot during operation. Walls and mantels above the firebox may become hot to the touch. If installed properly, these temperatures meet the requirement of the national product standard. Follow all minimum clearances shown in this manual. See Figure 5 and 11 on page 11.

INSTALLATION INTO PRE-FABRICATED MANTELS

The fireplace can be positioned into HearthSense cabinet mantels. Follow the installation instructions for mounting fireplace into mantel.

IMPORTANT: Only use HearthSense pre-fabricated cabinet mantels.

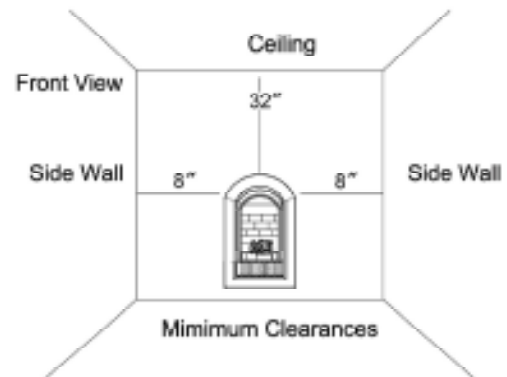

Figure 5 –Minimum Clearance To Wall And Ceiling

BUILT-IN FIREPLACE INSTALLATION

Built-in installation of this fireplace involves installing fireplace into a framed-in enclosure. This makes the front of the fireplace flush with wall.

IMPORTANT: Framing dimensions should allow for wall covering thickness and fireplace facing materials. Adjust rough opening size as necessary to maintain at least the minimum clearance requirements.

1. Frame in rough opening. Use dimensions shown in Figure 7 and 8 for the rough opening. If installing in a corner, use dimensions shown in Figure 9 for the rough opening.
2. Carefully set fireplace in rough opening. Once in place nail or screw the nailing brackets to the framing. See Figure 6 for nailing flanges position.
3. Attach gas line to fireplace. See "Connecting to Gas Supply," page 12.
4. Check all gas connections for leaks. See Checking Gas Connections, page 13.

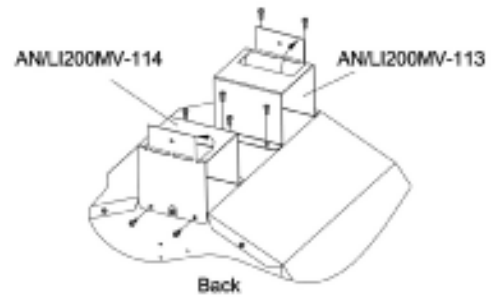

NOTE: Before installing the fireplace into a recessed space, installer must attach brackets to top of fireplace and bend outward 90 degrees.

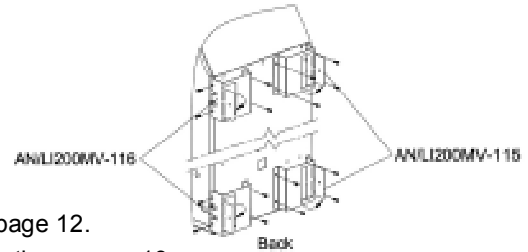

Figure 6 – Nailing Flanges

IMPORTANT: When finishing your firebox, combustible materials such as wall board, gypsum board, sheet rock, drywall, plywood, etc, must have 1" clearance to the sides and 3" to top of the firebox. The framing material may touch the nailing flange stand-offs, but no material should be placed between the nailing flange stand-offs. Combustible materials should never overlap the firebox front facing.



WARNING: Do not obstruct the upper and lower convection air passage areas to allow proper ventilation air around the fireplace. Room air enters through the lower passage, is heated and exits at the upper passage. Blocking these passages may result in overheating the fireplace creating a potentially hazardous condition.

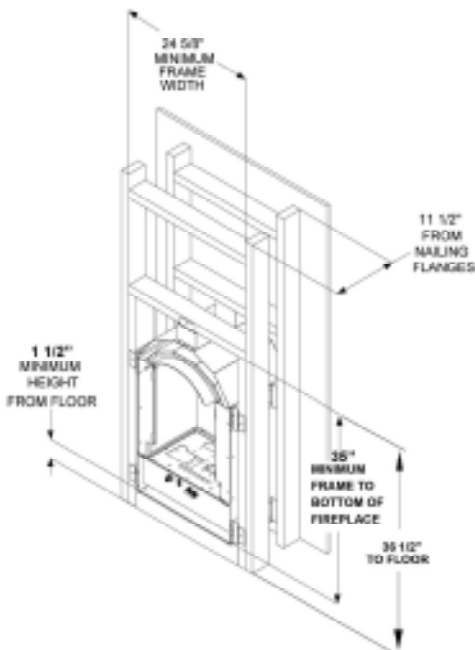

Figure 7- Cabinet Framing

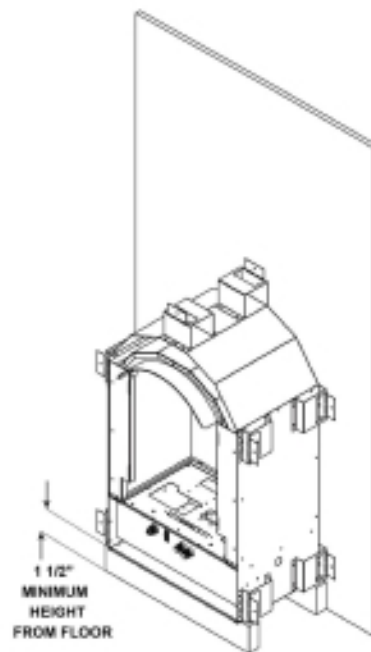

Figure 8- Flush To Back Mounting

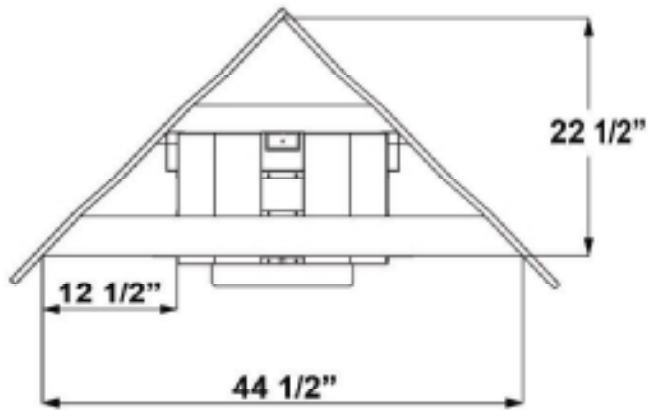

Figure 9- Corner Framing

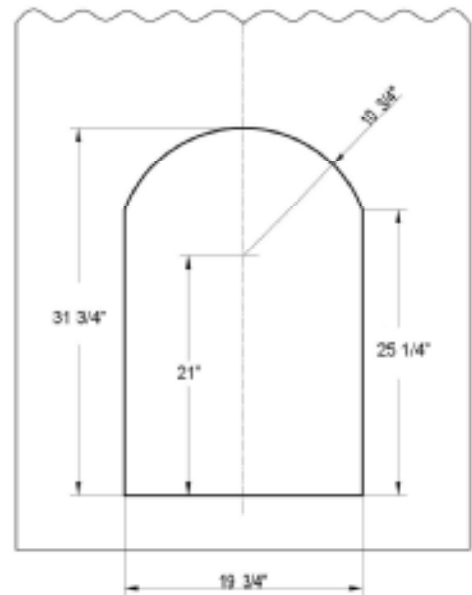
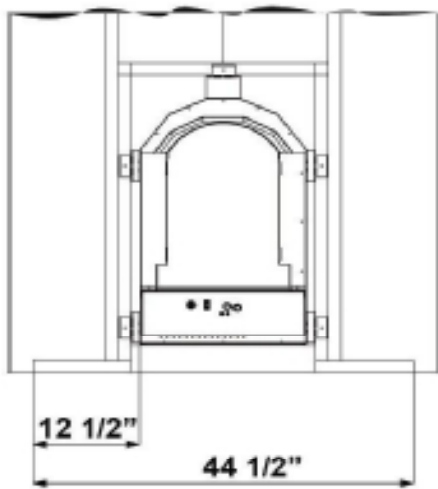

Figure10- Face Opening

Note: All vertical measurements are from top of fireplace opening to bottom of mantel shelf. All measurements are in inches.

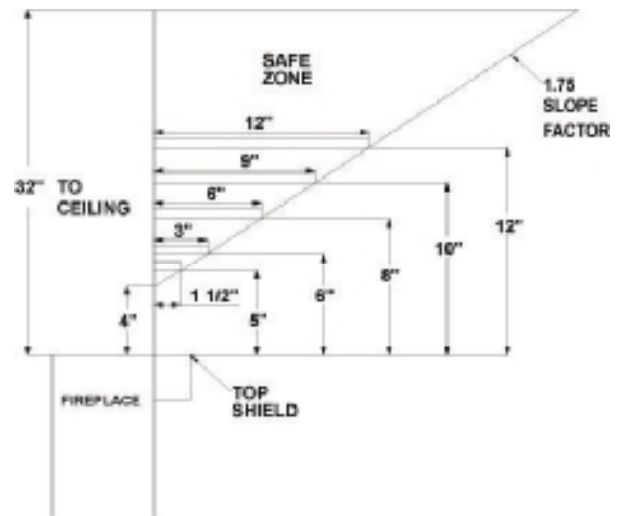

Figure11- Mantel Clearances

CONNECTING TO GAS SUPPLY

WARNING: A qualified technician must connect heater to gas supply. Follow all local codes.

CAUTION: Never connect heater directly to the gas supply. This heater requires an external regulator (not supplied). The external regulator between the gas supply and heater must be installed.

INSTALLATION ITEMS NEEDED

Before installing heater, make sure you have the items listed below:

- piping (check local codes)
- sealant (resistant to propane/LP gas)
- equipment shutoff valve*
- test gauge connection**
- sediment trap
- tee joint
- pipe wrench
- flexible gas (check local code)

* A CSA design-certified equipment shutoff valve with 1/8-inch NPT tap is an acceptable alternative to test gauge connection. Purchase the optional CSA design-certified equipment shutoff valve from your dealer.

WARNING: Never connect heater to private (non-utility) gas wells. This gas is commonly known as wellhead gas.

The installer must supply an external regulator. The external regulator will reduce incoming gas pressure. You must reduce incoming gas pressure to between 11 and 14 inches of water column for propane and between 5 and 10.5 inches of water column for natural gas. If you do not reduce incoming gas pressure, heater regulator damage could occur. Install external regulator with the vent pointing down as shown in Figure 12. Pointing the vent down protects it from freezing rain or sleet (see Figure 13).

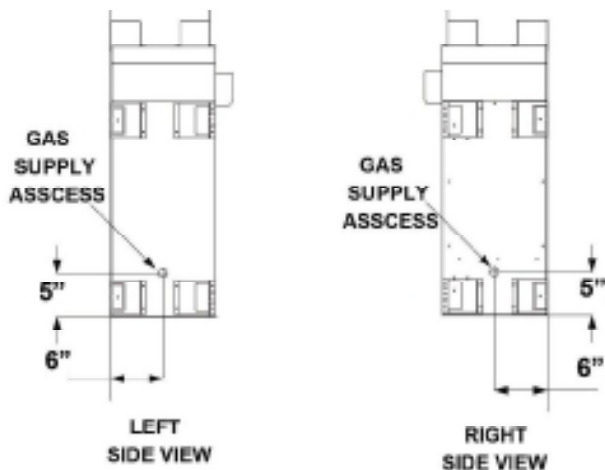

Figure 12- Gas Line Access Into Fireplace Cabinet

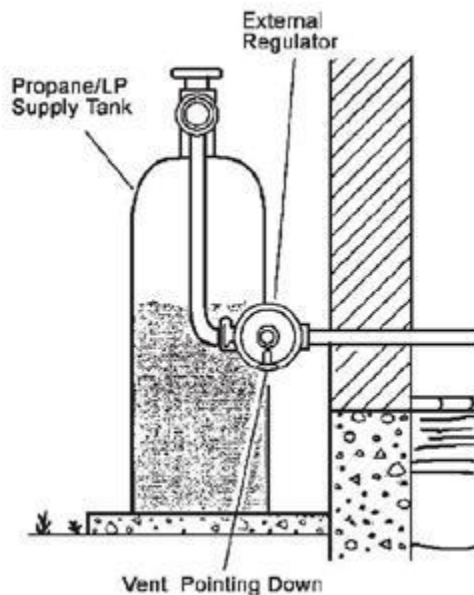

Figure 13 - External Regulator With Vent Pointing Down



CAUTION: Use new black iron or steel pipe only. Internally tinned copper tubing may be used in certain areas. Check your local codes. Use pipe of 1/2 inch diameter or greater to allow proper volume gas to heater. If pipe is too small, loss of pressure will occur. Installation must include an equipment shutoff valve, union, and plugged 1/8-inch NPT tap. Locate NPT tap within reach for test gauge hook up. NPT tap must be upstream from heater (see Figure 14).

IMPORTANT: Install equipment shutoff valve in an accessible location. The equipment shutoff valve is for turning on or shutting off the gas to the appliance. Apply pipe joint sealant lightly to male threads. This will prevent excess sealant from going into pipe. Excess sealant in pipe could result in clogged heater valves.



CAUTION: Use pipe joint sealant that is resistant to gas (PROPANE or NATURAL GAS). We recommend that you install a sediment trap in a supply line as shown in Figure 13. Place sediment trap where it is within reach for cleaning. Install in the piping system between fuel supply and heater. Place sediment trap where trapped matter is not likely to freeze. A sediment trap traps moisture and contaminants. This keeps them from going into heater controls. If sediment trap is not installed or is installed incorrectly, heater may not run properly.



CAUTION: Avoid damage to regulator. Hold gas regulator with wrench when connecting into gas piping and /or fittings. Gas supplier provide external regulator for natural gas.

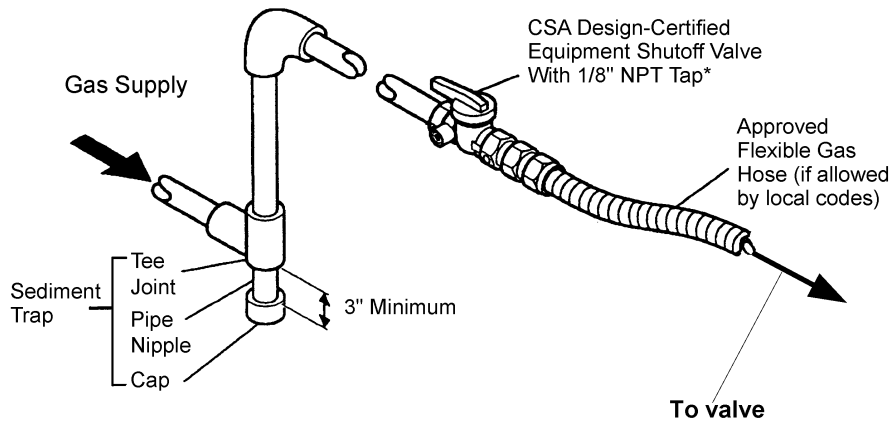

Figure 14 Gas connection

*Purchase the optional CSA design-certified equipment shut off valve from your dealer. See "Accessories".

** Minimum inlet pressure for purpose of input adjustment.

CHECKING GAS CONNECTIONS

WARNING: Test all gas piping and connections for leaks after installing or servicing. Correct all leaks immediately.

Pressure Testing Gas Supply Piping System

Test Pressures In Excess Of 1/2 PSIG(3.5kPa)

1. Disconnect heater with its appliance main gas valve (control valve) and equipment shutoff valve from gas supply piping system. Pressures in excess of 1/2 psig will damage heater regulator.
2. Cap off open end of gas pipe where equipment shutoff valve was connected.
3. Pressurize supply piping system by either using compressed air or opening gas supply tank valve.
4. Check all joints of gas supply piping system. Apply mixture of liquid soap and water to gas joints. Bubbles forming show a leak.
5. Correct all leaks immediately.
6. Reconnect heater and equipment shutoff valve to gas supply. Check reconnected fittings for leaks.

WARNING: Never use an open flame to check for a leak. Apply a mixture of liquid soap and water to all joints. Bubbles forming show a leak. Correct all leaks immediately.

Pressure Testing Heater Gas Connections

1. Open equipment shutoff valve (see Figure 15).
2. Open gas supply tank valve.
3. Make sure control knob of heater is in the OFF position.
4. Check all joints from equipment shutoff valve to control valve.
Apply mixture of liquid soap and water to gas joints. Bubbles forming show a leak.
5. Correct all leaks immediately.
6. Light heater (see *Operating*, page 17). Check all other internal joints for leaks.
7. Turn off heater (see *To Turn Off Gas to Appliance*, P18).

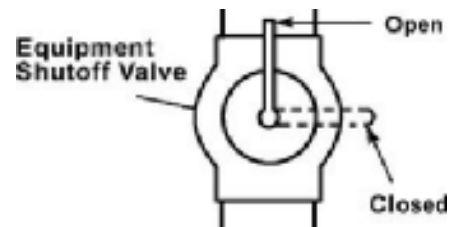

Figure 15 –Equipment Valve

CAUTION: Make sure external regulator has been installed between gas supply and heater. See guidelines under "Connecting to Gas Supply" (page 12).

Test Pressures Equal To or Less Than 1/2 PSIG (3.5 kPa)

1. Close equipment shutoff valve (see Figure 15, page 14).
2. Pressure supply piping system by either using compressed air or opening gas supply tank valve.
3. Check all joints from gas meter to equipment shutoff valve (see Figure 15).
4. Apply mixture of liquid soap and water to gas joints. Bubbles forming show a leak.
5. Correct all leaks immediately.

ELECTRICAL WIRING (MILLIVOLT)

CAUTION: Label all wires prior to disconnection when servicing controls. Wiring errors can cause improper and dangerous operation. Verify proper operation after servicing.

The millivolt valve is a self-powered combination gas control THAT DOES NOT REQUIRE 110 VAC TO OPERATE.

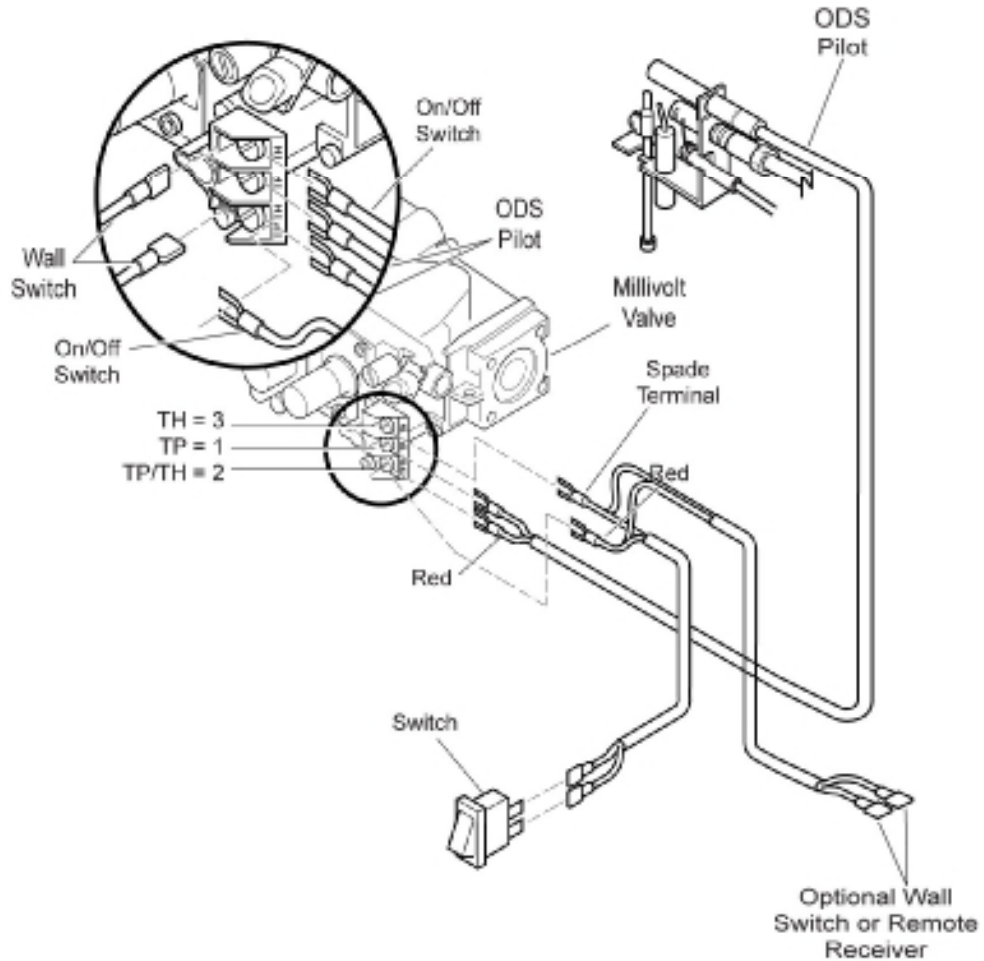

Figure 16 Wiring Diagram

INSTALLATION

Continued

⚠ WARNING: Failure to position the parts in accordance with these diagrams or failure to use only parts included may result in property damage or personal injury

⚠ CAUTION: After installation, and periodically thereafter, check to ensure that no flame comes in contact with any log. With the heater set to High, check to see if flames contact any log. If so, reposition logs according to the log installation instructions in this manual. Flames contacting logs will create soot.

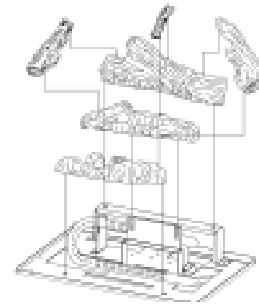

Figure 17 - Installing Log Set

IMPORTANT: Make sure logs do not cover any burner ports. It is very important to install the logs exactly as instructed. Do not modify logs. Use logs supplied with heater only.

Figure 18



1. All logs.

Figure 20



STEP 3: Install the log 3 onto the two slots in front plate.

Figure 22



STEP 5: Insert the recessed hole on upper part of log 5 onto the pin on log 2. Place the recessed hole on lower part of log 5 onto the pin on log 3.

Figure 19



STEP 1: Install log 1 onto the two slots in rear plate.

STEP 2: Install log 2 onto the two slots in middle plate.

Figure 21



STEP 4: Insert the recessed hole on upper part of log 4 onto the pin on log 1. Place the recessed hole on lower part of log 4 onto the pin on log 3.

Figure 23



STEP 6: Insert the recessed hole in log 6 onto the pin on log 2 and position on log 1.

OPERATING INSTRUCTIONS

FOR YOUR SAFETY

READ BEFORE LIGHTING

WARNING: If you do not follow these instructions exactly, a fire or explosion may result causing property damage, personal injury or loss of life.

CAUTION: Do not try to adjust heating levels by using the equipment shutoff valve.

NOTICE: During initial operation of new heater, logs will give off a paper-burning smell. Orange flame will also be present. Open a window to vent smell. This will only last a few hours.

- A. This appliance is equipped with an ignition device which automatically lights the pilot. Do not try to light the pilot by hand.
- B. BEFORE LIGHTING smell all around the appliance area for gas. Be sure to smell next to the floor because some Gas is heavier than air and will settle on the floor.

WHAT TO DO IF YOU SMELL GAS

- Do not try to light any appliance.
 - Do not touch any electrical switch; do not use any phone in your building.
 - Immediately call your gas supplier from a neighbor's phone. Follow the gas supplier's instructions.
 - If you cannot reach your gas supplier, call the fire department.
- C. Use only your hand to push controls. Never use tools. If the appliance does not operate, don't try to repair it, Call a qualified service technician or gas supplier. Forced or attempted repair may result in a fire or explosion.
 - D. Do not use this appliance if any part has been under water. Immediately call a qualified service technician to inspect the appliance and to replace any part of the control system and any gas control which has been under water.

Function of Manual Power ON/OFF Switch

Note: To operate your heater the ON/OFF switch must be in the ON position.

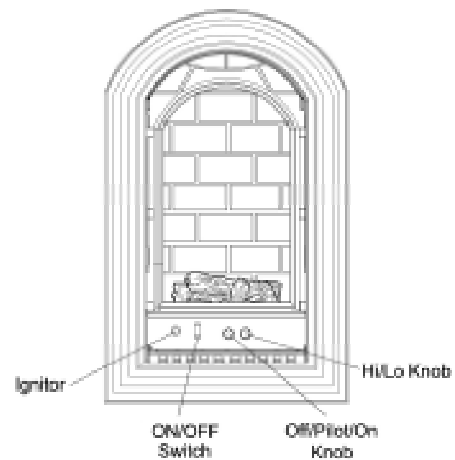





Figure 24-Operating Control

OPERATING INSTRUCTIONS

1. STOP! Read " FOR YOUR SAFETY " on page 17.
2. Unscrew ignitor cap and install a AAA type battery with the anode (+) pointing out. Replace cap.
3. Make sure manual shutoff valve is fully open.
4. Turn gas control knob clockwise  to the "OFF" position, set the thermostat to lowest setting and turn ON/OFF switch to OFF position.
5. Wait five (5) minutes to clear out any gas. Then smell for gas, including near the floor. If you smell gas, STOP! Follow "B" in the safety information label. If you don't smell gas, go to next step.
6. From "OFF" position, turn the gas control knob counterclockwise  to "PILOT" position. Push in control for 5 seconds.
7. With the control knob pushed in, push in and release the ignitor button to light the pilot.
8. Continue pushing the control knob in for a further 60 seconds to prevent the flame detector from shutting off the gas while the probe is warming up. Release the control knob.
9. Turn gas control knob counterclockwise  to the ON position.
10. After the pilot has been lit for one minute, the burners can be turned on. Turn the ON/OFF switch to ON position and adjust HI-LO knob to desired setting.
11. If the heater will not operate, follow the instructions "To Turn Off Gas To Appliance" and call your service technician or gas supplier.
12. Wait 30 seconds before readjusting the heater when the control knob has been turned down to a lower setting.

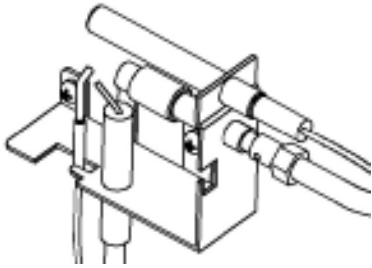

Figure 25-Pilot

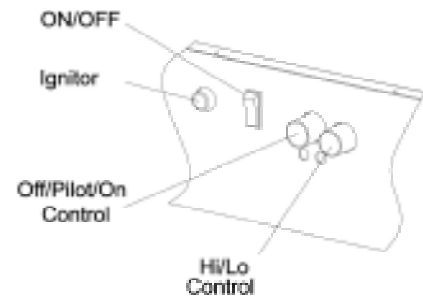

Figure 26-Control Plate

TO TURN OFF GAS TO APPLIANCE

Push in gas Control Knob slightly and turn clockwise to the OFF position. Do not force.

MANUAL LIGHTING PROCEDURE

(match light)

1. Remove front panel .
2. Follow steps 1 through 5 under *OPERATING INSTRUCTIONS*.
3. With Control Knob in PILOT position, strike match, and hold near pilot. Press in Control Knob, pilot should light.
4. Keep Control Knob pressed in for 30 seconds after lighting pilot. After 30 seconds, release Control Knob. Follow step 9 under *OPERATING INSTRUCTIONS*.

INSPECTING BURNERS

Check pilot flame pattern and burner flame patterns often.

PILOT FLAME PATTERN

1. Turn control knob to pilot position
2. Inspect pilot flame and refer to Figure 27 and 28.
 - Figure 27 shows a correct pilot flame pattern.
 - Figure 28 shows an incorrect pilot flame pattern. The incorrect pilot flame is not touching the thermocouple. This will cause the thermocouple to cool. When the thermocouple cools, the heater will shut down.
 - If the pilot flame is incorrect, as shown in Figure 28. Turn heater off (see To Turn Off Gas to Appliance, page 18) See troubleshooting, page 21.

BURNER FLAME PATTERN

- Figure 31 shows a correct burner flame pattern.
- Figure 32 shows an incorrect burner flame pattern. If burner flame is incorrect: Turn heater off (see To Turn Off Gas to Appliance, page 18) see Troubleshooting, Page 21.



Figure 31- Correct Flame Pattern with Control Knob Set to High Flame (5)

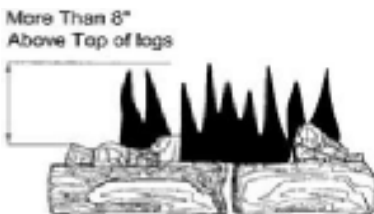

Figure 32 -Incorrect Flame Pattern with Control Knob Set to High (5)

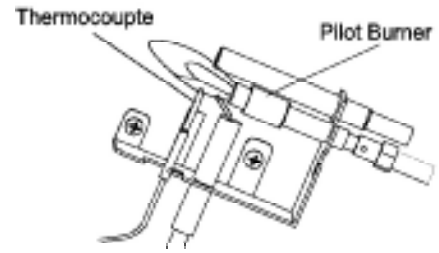

Figure 27 -Correct Pilot Flame Pattern- ANI model

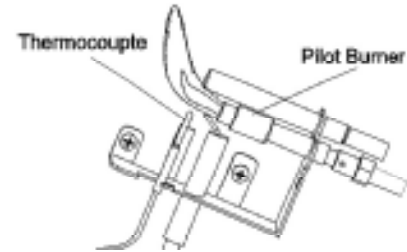

Figure 28- Incorrect Pilot Flame Pattern- ANI model

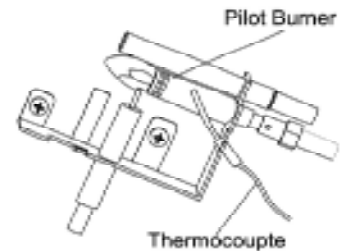

Figure 29-Correct Pilot Flame Pattern- ALI model

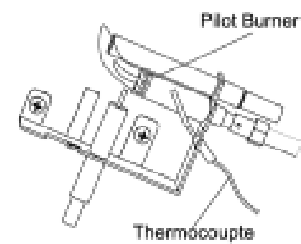

Figure 30-Incorrect Pilot Flame Pattern- ALI model

CLEANING AND MAINTENANCE



WARNING: Failure to keep primary air openings of burners clean may result in sooting and property damage.



CAUTION: You must keep control areas, burner, and circulating air passageways of heater clean. Inspect these areas of heater before each use. Have heater inspected yearly by a qualified service person. Heater may need more frequent cleaning due to excessive lint from carpeting, bedding material, pet hair, etc.

CLEANING ODS/IGNITOR AND BURNER

Clean with a vacuum cleaner.

CLEANING BURNER INJECTOR HOLDER AND PILOT AIR INLET HOLE

We recommend that you clean the unit every three months or after 2500 hours of operation. We also recommend that you keep the burner tube and pilot assembly clean and free of dust and dirt. To clean these parts we recommend using compressed air no greater than 30 PSI. You can use a vacuum cleaner in the blow position. If using compressed air in a can, please follow the directions on the can. If you don't follow directions on the can, you could damage the pilot assembly.

1. Shut off the unit, including the pilot. Allow the unit to cool for at least thirty minutes.
2. Inspect burner, pilot and primary air inlet holes on injector holder for dust and dirt (see Figure 32).
3. Blow air through the ports/slots and holes in the burner.
4. Check the injector holder located at the end of the burner tube again. Remove any large particles of dust, dirt, lint, or pet hair with a soft cloth or vacuum cleaner nozzle.
5. Blow air into the primary air holes on the injector holder.
6. In case any large clumps of dust have now been pushed into the burner. Repeat steps 3 and 4. Clean the pilot assembly also. A yellow tip on the pilot flame indicates dust and dirt in the pilot assembly. There is a small pilot air inlet hole about two inches from where the pilot flame comes out of the pilot assembly (see Figure 33). With the unit off, lightly blow air through the air inlet hole. You may blow through a drinking straw if compressed air is not available.

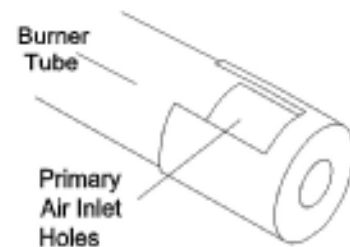

Figure 32 – Injector holder on Outlet Burner Tube

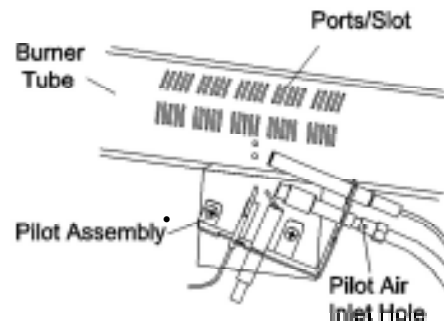

Figure 33 – Pilot Air Inlet Hole

CABINET

- Air Passageways
- Use a vacuum cleaner or pressurized air to clean the cabinet to remove dust.

LOGS

- If you remove logs for cleaning, refer to Installing Logs (page 16) for proper log placements.
- Replace logs if broken or chipped (dime-sized or larger).

MAIN BURNER

Periodically inspect all burner flame holes with the heater running. All slotted burner flame holes should be open with yellow flame present. All round burner flame holes should be open with a small blue flame Present. Some burner flame holes may become blocked by debris or rust, with no flame present. If so, turn off heater and let cool, either remove blockage or replace burner. Blocked burner flame holes will create soot.

TROUBLESHOOTING

NOTE: Turn the control knob to "off" position first and wait for one minute. Then turn the control knob to on position. Please wait for one minute to allow valve to reset.



WARNING: If you smell gas

- Shut off gas supply.
- Do not try to light any appliance.
- Do not touch any electrical switch; do not use any phone in your building.
- Immediately call your gas supplier from a neighbor's phone. Follow the gas supplier's instructions.
- If you cannot reach your gas supplier, call the fire department.



WARNING: Make sure that power is turned off before proceeding.



WARNING: Turn off and let cool before servicing. Only a qualified service person should service and repair fireplace.



CAUTION: Never use a wire, needle, or similar object to clean ODS/pilot. This can damage ODS/pilot unit.

| OBSERVED PROBLEM | POSSIBLE CAUSE | REMEDY |
|--|--|---|
| When ignitor button is pressed in, there is no spark at ODS/pilot | <ol style="list-style-type: none"> 1. Ignitor is positioned wrong. 2. Ignitor electrode is broken. 3. Ignitor electrode is not connected to ignitor cable. 4. Ignitor cable is pinched. 5. Damaged ignitor cable. 6. Bad piezo ignitor. 7. Low battery. | <ol style="list-style-type: none"> 1. Replace ignitor. 2. Replace ignitor.. 3. Reconnect ignitor cable. 4. Free ignitor cable if pinched by any metal or tubing. 5. Replace ignitor cable. 6. Replace piezo ignitor. 7. Replace battery. |
| When ignitor button is pressed in, there is a spark at ODS/pilot but no pilot flame present. | <ol style="list-style-type: none"> 1. Gas supply is turned off or equipment shutoff valve is closed. 2. Control knob not fully pressed in while pressing ignitor button. 3. Air in gas lines (new installation or recent gas interruption). 4. ODS/pilot is clogged. 5. Incorrect inlet gas pressure or regulator is damaged. 6. Depleted gas supply | <ol style="list-style-type: none"> 1. Turn on gas supply or open equipment shutoff valve. 2. Fully press in control knob while pressing ignitor button. 3. Continue holding down control knob for 30 seconds to remove air. Repeat igniting operation until air is removed. 4. Clean ODS/pilot (see <i>Cleaning and Maintenance</i> Page 20) or replace ODS/pilot assembly. 5. Check inlet gas pressure or replace gas valve. 6. Contact local propane/LP Gas Company |
| ODS/pilot lights but flame goes out when control knob is released. | <ol style="list-style-type: none"> 1. Control knob is not fully pressed in. 2. Control knob is not pressed in long enough. 3. Equipment shutoff valve is not fully open. 4. Thermocouple connection is loose. 5. Thermocouple damaged 6. Control valve damaged. | <ol style="list-style-type: none"> 1. Press in control knob fully. 2. After ODS/pilot lights, keep control knob pressed in 30 seconds. 3. Fully open equipment shutoff valve. 4. Hand tighten until snug, and then tighten ¼ turn more. 5. Replace pilot. 6. Replace control valve. |

TROUBLESHOOTING (Continued)

| OBSERVED PROBLEM | POSSIBLE CAUSE | REMEDY |
|--|--|--|
| Burner(s) does not light after ODS/pilot is lit. | <ol style="list-style-type: none"> 1. Burner orifice is clogged. 2. Burner orifice diameter is too small. 3. Inlet gas pressure is too low. | <ol style="list-style-type: none"> 1. Burner orifice (see <i>Cleaning and maintenance</i> Page 20) or replace burner orifice. 2. Replace burner orifice. 3. Contact your gas supplier. |
| Delayed ignition of burner(s). | <ol style="list-style-type: none"> 1. Manifold pressure is too low. 2. Burner orifice is clogged. | <ol style="list-style-type: none"> 1. Contact your gas supplier. 2. Clean burner (see <i>Cleaning and maintenance</i> Page 20) or replace burner orifice. |
| Burner backfiring during combustion. | <ol style="list-style-type: none"> 1. Burner orifice is clogged or damaged. 2. Burner is damaged. 3. Gas regulator is damaged. | <ol style="list-style-type: none"> 1. Clean burner orifice (see <i>Cleaning and maintenance</i> Page 20) replace. 2. Contact Dealer or Customer Service. 3. Replace gas valve. |
| High yellow flame during burner combustion. | <ol style="list-style-type: none"> 1. Dirty or clogged burner. 2. Gas regulator is defective. 3. Inlet gas pressure is too low. | <ol style="list-style-type: none"> 1. Check burner for dirt and debris. If found, clean burner (see <i>Cleaning and Maintenance</i> Page 20). 2. Replace gas valve. 3. Check inlet pressure. |
| Slight smoke or odor during initial operation | <ol style="list-style-type: none"> 1. Residues from manufacturing process. | <ol style="list-style-type: none"> 1. Problem will stop after a few hours of operation. |
| Heater produces a whistling noise when burner is lit. | <ol style="list-style-type: none"> 1. Turning control knob to HI position when burner is cold. 2. Air in gas line. 3. Air passageways on heater are blocked. 4. Dirty or partially clogged burner orifice. | <ol style="list-style-type: none"> 1. Turn control knob to LO position and let warm up for a minute. 2. Operate burner until air is removed from line. Have gas line checked by local propane/LP Gas Company. 3. Observe minimum installation clearances (Figure 5, page 9) 4. Clean burner (see <i>Cleaning and Maintenance</i> Page 20) or replace burner orifice. |
| Heater produces a clicking/ticking noise just after burner is lit or shut off. | <ol style="list-style-type: none"> 1. Metal is expanding while heating or contracting while cooling. | <ol style="list-style-type: none"> 1. This is common with most heaters. If noise is excessive, contact qualified service technician. |
| White powder residue forming within burner box or on adjacent walls or furniture | <ol style="list-style-type: none"> 1. When heated, the vapors from furniture polish, wax, carpet cleaners, etc., turn into white powder residue. | <ol style="list-style-type: none"> 1. Turn heater off when using furniture polish, wax, carpet cleaner or similar products. |

| | | |
|--|---|--|
| When ignitor button is pressed in, | <ol style="list-style-type: none"> 1. Ignitor is positioned wrong. 2. Ignitor electrode is broken. 3. Ignitor electrode is not connected to ignitor cable. 4. Ignitor cable is pinched or wet. 5. Broken ignitor cable. 6. Bad piezo ignitor. | <ol style="list-style-type: none"> 1. Replace ignitor. 2. Replace pilot. 3. Reconnect ignitor cable. 4. Free ignitor cable if pinched by any metal or tubing. Keep ignitor cable dry. 5. Replace ignitor cable. 6. Replace piezo ignitor. |
| When ignitor button is pressed in, there is no spark at ODS/pilot. | <ol style="list-style-type: none"> 1. Gas supply is turned off or equipment shutoff valve is closed. 2. Control knob not fully pressed in while pressing ignitor button. 3. Air in gas lines when installed. 4. ODS/pilot is clogged. 5. Gas regulator setting is not correct. 6. Bad piezo ignitor. 7. Depleted gas supply. | <ol style="list-style-type: none"> 1. Turn on gas supply of open equipment shutoff valve. 2. Fully press in control knob while pressing ignitor button. 3. Continue holding down control knob. Repeat igniting operation until air is moved. 4. Clean ODS/pilot (see <i>Cleaning and Maintenance</i> Page 20) or replace ODS/pilot assembly. 5. Replace gas valve. 6. Replace ignitor. 7. Contact your local gas company. |
| ODS/pilot lights but flame goes out when control knob is released | <ol style="list-style-type: none"> 1. Control knob is not fully pressed in. 2. Control knob is not pressed in long enough. 3. Equipment shutoff valve is not fully open. 4. Thermocouple connection is loose at the control valve. 5. Thermocouple damaged. 6. Control valve damaged. | <ol style="list-style-type: none"> 1. Press in control knob fully. 2. After ODS/pilot lights, keep control knob pressed in 30 seconds. 3. Fully open equipment shutoff valve. 4. Hand tighten until snug, and then tighten 1/4 turn more. 5. Replace pilot. 6. Contact Dealer or Customer Service. |

REPLACEMENT PARTS

REPLACEMENT PARTS

NOTE: Use only original replacement parts. This will protect your warranty coverage for parts replaced under warranty.

PARTS UNDER WARRANTY
 Contact authorized dealers of this product. If they can't supply original replacement parts, call Customer Service toll free number at (1-877-886-5989) for referral information.

PARTS NOT UNDER WARRANTY
 Contact authorized dealers of this product. If they can't supply original replacement part(s), Call Customer Service toll free number at (1-877-886-5989) for referral information.

When calling Customer Service, or your dealer, have ready:
 Your Name
 Your Address
 Mode and serial numbers of your heater
 How heater was malfunctioning
 Type of gas used (propane/LP or NG)
 Purchase date
 Warranty card
 Usually, we will ask you to return

When calling Customer Service, have ready
 Model number of your heater
 The replacement part number

ANI & ALI PARTS LIST

This list contains replaceable parts used in your heater. When ordering parts, follow the instructions listed under Replacement Parts on page 23 of this manual.

| KEY NO | PART NUMBER | DESCRIPTION | QUANTITY | |
|--------|----------------|----------------------|----------|-----|
| | | | ANI | ALI |
| 1 | AL092-01 | Ignitor | 1 | 1 |
| 2 | AN/LI200MV-205 | Control Panel | 1 | 1 |
| 3 | MV0.820.636 | MV Valve – ALI | | 1 |
| 3 | MV0.820.637 | MV Valve – ANI | 1 | |
| 4 | AN/LI200MV-230 | Burner Assembly | 1 | 1 |
| 5 | AN/LI200MV-234 | Inlet | 1 | 1 |
| 6 | AN/LI200MV-240 | Outlet Tube Assembly | 1 | 1 |
| 7 | AN/LI200MV-239 | ODS INTLET TUBE (LP) | | 1 |
| 7 | AN/LI200MV-240 | ODS INTLET TUBE (NG) | 1 | |
| 8 | AN/LI200MV-204 | MV Valve Bracket | 1 | 1 |
| 9 | AN/LI200MV-209 | HI/LO Knob | 1 | 1 |
| 10 | AN/LI200MV-209 | OFF/PILOT/ON Knob | 1 | 1 |
| 11 | VL067-01 | Switch | 1 | 1 |
| 12 | NRV81F1-3 | Regulator | 1 | |

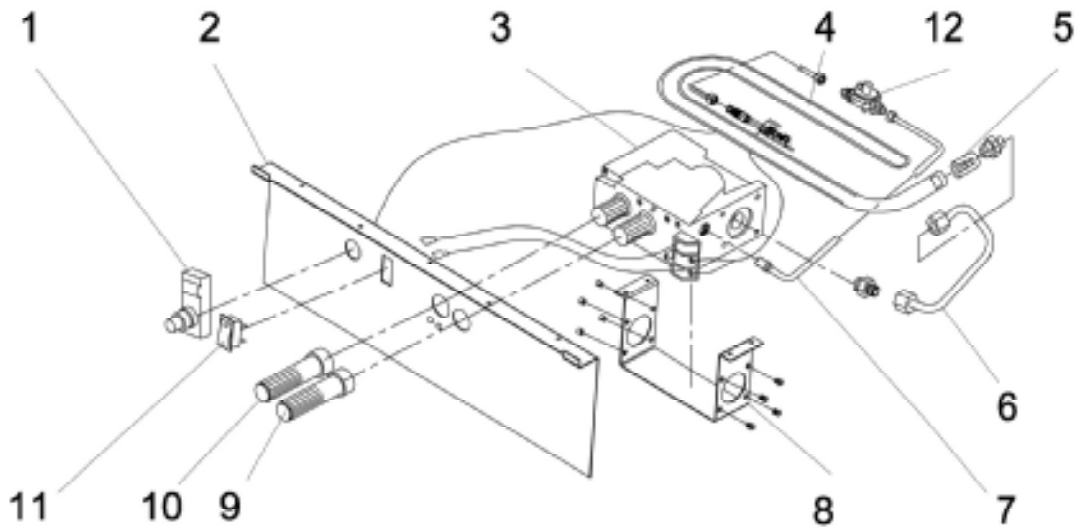

PARTS LIST

This list contains replaceable parts used in your heater. When ordering parts, follow the instructions listed under Replacement Parts on page 23 of this manual.

**ANI
ALI**

| KEY NO | PART NUMBER | DESCRIPTION | QUALITY |
|--------|----------------|--------------------|---------|
| 1 | AN/LI200MV-221 | Top Reflector | 1 |
| 2 | AN/LI200MV-101 | Top Cover Board | 1 |
| 3 | AN/LI200MV-104 | Back Cover Board | 1 |
| 4 | AN/LI200MV-110 | Top Board Assembly | 1 |
| 5 | AN/LI200MV-205 | Control Panel | 1 |
| 6 | AN/LI200MV-102 | Right Side | 1 |
| 7 | AN/LI200MV-105 | Bottom | 1 |
| 8 | AN/LI200MV-141 | Access Door | 1 |
| 9 | AN/LI200MV-122 | Glass Frame | 1 |
| 10 | AN/LI200MV-124 | Glass | 1 |
| 11 | AN/LI200MV-121 | Front Panel Frame | 1 |
| 12 | AN/LI200MV-103 | Left Side | 1 |

