



Thank you for purchasing RYOBI™ Phone Works™

If you need assistance
DO NOT RETURN TO THE STORE
Please contact us at 1-877-578-6736

This app is optimized for:

iOS versions 6.0 and higher • Android versions 4.0 and higher
For a full list of compatible phones please visit
www.ryobitools.com/phoneworks

ES2000 INFRARED THERMOMETER IMPORTANT SAFETY INSTRUCTIONS

⚠ WARNING!

READ AND UNDERSTAND ALL INSTRUCTIONS. Failure to follow all instructions listed below, may result in electric shock, fire and/or serious personal injury.

⚠ WARNING:

Changes or modifications to this unit not expressly approved by the party responsible for compliance could void the user's authority to operate the equipment.

⚠ WARNING:

Use of controls, adjustments, or performance of procedures other than those specified here can result in hazardous radiation exposure.

- **Read operator's manual carefully. Learn the applications and limitations, as well as the specific potential hazards, related to this device.** Following this rule will reduce the risk of electric shock, fire, or serious injury.
- **Do not operate battery devices in explosive atmospheres, such as in the presence of flammable liquids, gases or dust.** Battery devices create sparks which may ignite the dust or fumes.
- **Do not disassemble the device.** Contact with internal parts may increase the risk of electric shock or cause damage to the device.
- **Do not use on a ladder or unstable support.** Stable footing on a solid surface enables better control of the device in unexpected situations.
- **Do not store the device in an area of high heat or humidity. Do not expose the device to extended high heat from the sun (such as on a vehicle dashboard.) To reduce the risk of serious personal injury, do not store outside or in vehicles.** Damage to the device or the battery can result.

App images may vary.

⚠ DANGER LASER RADIATION AVOID DIRECT EYE EXPOSURE
Maximum output <5 mW Wavelength: 630-670nm
Class IIIa laser product
AVOID EXPOSURE: Laser radiation ▼ is emitted from this aperture.

⚠ WARNING

AVOID EXPOSURE: Laser radiation emitted from this aperture.

⚠ AVERTISSEMENT

EVITER L'EXPOSITION :
Rayonnement laser émise de cet orifice.

⚠ ADVERTENCIA

EVITE LA EXPOSICIÓN:
Radiación laser se emite por esta abertura.



Aperture

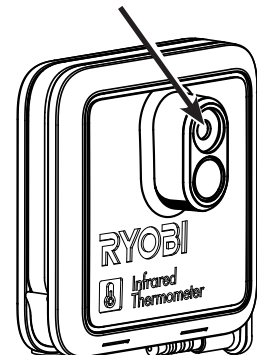



- **Do not expose device to rain or wet conditions.** Water entering a device will increase the risk of electric shock.
- **Use the device in accordance with these instructions and in the manner intended for the device, taking into account the environmental conditions and the work to be performed.** Use of the device for operations different from those intended could result in a hazardous situation.
- **Do not use as a precision thermometer.**
- **Do not use the thermometer for medical evaluations or to measure body temperature.** This device is meant for household use only.

IMPORTANT SAFETY INSTRUCTIONS



- **The laser guide radiation used in the device is Class IIIa, <5 mW, 630-670nm wavelengths.**
- **Avoid direct eye exposure when using the laser and do not project the laser beam directly into the eyes of others.** Serious eye injury could result.
- **Do not remove or deface any product labels.** Removing product labels increases the risk of exposure to laser radiation.
- **Do not place the device in a position that may cause anyone to stare into the laser beam intentionally or unintentionally.** Serious eye injury could result.
- **Do not operate the laser device around children or allow children to operate the tool.** Serious eye injury could result.
- **Always turn the laser off when not in use.** Leaving the device on increases the risk of someone inadvertently staring into the laser beam.
- **Do not operate the device in combustible areas such as in the presence of flammable liquids, gasses, or dust.**
- **Always ensure the laser beam is aimed at a surface without reflective properties.** Shiny reflective materials are not suitable for laser use.
- **The laser shall be used and maintained in accordance with the manufacturer's instructions.**
- **Never aim the beam at a person or object other than the target surface.**
- **Handle the instrument with care.** Treat it as you would any other optical device such as a camera or binoculars.
- **Avoid exposing the instrument to shock, continuous vibration, or extreme hot or cold temperatures.** Damage to the device and/or serious injury to the user could result.
- **Ensure the device is disconnected and turned off before inserting or changing batteries.**
- **Do not mix old and new batteries or different brands of batteries.**
- **Remove batteries from the device when not in use for an extended time.**
- **Always replace the alkaline battery with the same type of alkaline battery.** Use of any other battery packs may create a risk of injury and fire.
- **Under abusive conditions, liquid may be ejected from the battery, avoid contact. If contact accidentally occurs, flush with water. If liquid contacts eyes, additionally seek medical help.** Liquid ejected from the battery may cause irritation or burns.
- **This device should not be used unless the battery compartment is closed.**
- **Do not place battery devices or their batteries near fire or heat.** This will reduce the risk of explosion and possibly injury.
- **Do not crush, drop or damage battery. Do not use batteries that have been dropped or received a sharp blow.** A damaged battery is subject to explosion. Properly dispose of a dropped or damaged battery immediately.
- **Batteries can explode in the presence of a source of ignition, such as a pilot light.** To reduce the risk of serious personal injury, never use any battery device in the presence of open flame. An exploded battery can propel debris and chemicals. If exposed, flush with water immediately.
- **Under extreme usage or temperature conditions, battery leakage may occur. If liquid comes in contact with your skin, wash immediately with soap and water. If liquid gets into your eyes, flush them with clean water for at least 10 minutes, then seek immediate medical attention.** Following this rule will reduce the risk of serious personal injury.
- **Save these instructions.** Refer to them frequently and use them to instruct others who may use this device. If you loan someone this device, loan them these instructions also.

SYMBOLS

The following signal words and meanings are intended to explain the levels of risk associated with this device.

SYMBOL	SIGNAL	MEANING
	DANGER:	Indicates an imminently hazardous situation, which, if not avoided, will result in death or serious injury.
	WARNING:	Indicates a potentially hazardous situation, which, if not avoided, could result in death or serious injury.
	CAUTION:	Indicates a potentially hazardous situation, which, if not avoided, may result in minor or moderate injury.
	NOTICE:	(Without Safety Alert Symbol) Indicates important information not related to an injury hazard, such as a situation that may result in property damage.

Some of the following symbols may be used on this device. Please study them and learn their meaning. Proper interpretation of these symbols will allow you to operate the device better and safer.

SYMBOL	NAME	DESIGNATION/EXPLANATION
	Safety Alert	Indicates a potential personal injury hazard.
	Read Operator's Manual	To reduce the risk of injury, user must read and understand operator's manual before using this device.
V	Volts	Voltage
min	Minutes	Time
—	Direct Current	Type or a characteristic of current

FEATURES

Temperature Range -22°F to 662°F
 Laser Certifications Class IIIa<5mW, 630-670 nm
 Ambient Operating Temperature Range 32°F to 122°F (0°C to 50°C)

- Attaches directly to your phone using the clip (included)
- Check outdoor temperature
- Low/high temperature range setting
- Camera for image capture
- History feature with sharing capability
- Detect hot/cold spots in door and window seals to help pinpoint draft areas or leakage of warm or cool air
- Check the temperature of air vents
- Check the exterior/interior surfaces of household items and appliances
- **Automotive applications**

FEATURES

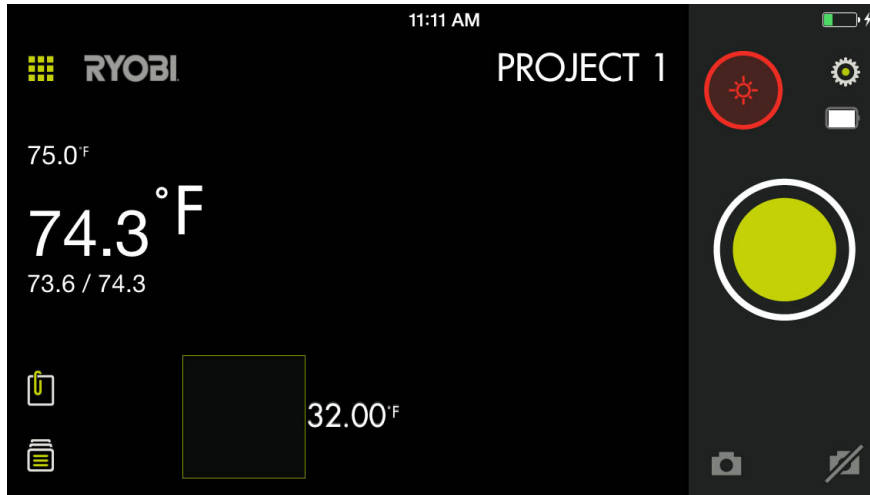

ICON	DESCRIPTION / FUNCTION
	Main RYOBI™ Phone Works™ app home screen
	Laser is ON
	Laser is OFF
	Take a picture
	Device battery charge level

ICON	DESCRIPTION / FUNCTION
	Camera ON
	Camera OFF
	Note
	File cabinet (stored projects)
	Settings

ASSEMBLY

WARNING:

Do not use this device if it is not completely assembled or if any parts appear to be missing or damaged. Use of a device that is not properly and completely assembled or with damaged or missing parts could result in serious personal injury.

WARNING:

Do not attempt to modify this device or create accessories not recommended for use with this device. Any such alteration or modification is misuse and could result in a hazardous condition leading to possible serious personal injury.

If any parts are damaged or missing, please call 1-877-578-6736 for assistance.

App images may vary.

OPERATION

INSTALLING/REPLACING THE BATTERY

See Figure 1.

One AAA battery is preinstalled in the device. Before first use, locate and remove the red pull tab to activate the batteries.

- Disconnect the device from your smartphone.
- Remove the battery cover by inserting the edge of a coin into the slot and twisting.
- Install the battery according to the polarity indicators.
- Align the two sections of the device and snap together to close.
- Make sure the device is securely closed before attaching to the clip.

NOTE: Remove the battery for storage when device will not be used for long periods of time.

ATTACHING THE PHONE CLIP

See Figure 2.

The phone clip expands to fit most smartphones. Always install the clip before attaching your smartphone.

- Align the hook-and-loop sections of the device to the matching portion of the clip.
- Make sure the two notches match and line up.
- With both thumbs, press the clip in the middle until you hear a “click”.
- Make sure clip is securely attached to the device.

CONNECTING THE IR THERMOMETER TO YOUR SMARTPHONE

See Figure 3.

- Insert the smartphone into the clip and make sure it is securely attached before use.
- Select and open the RYOBI™ Phone Works™ app.
- Insert the device's plug into your smartphone's headphone jack.
- Open the IR THERMOMETER app segment.
- The user must read the Laser Radiation DANGER that appears on the screen. The app will not become active until the user taps **OK** at the bottom right of the screen.

NOTE: The user must tap **OK** any time this screen appears before operating the thermometer.

Fig. 1

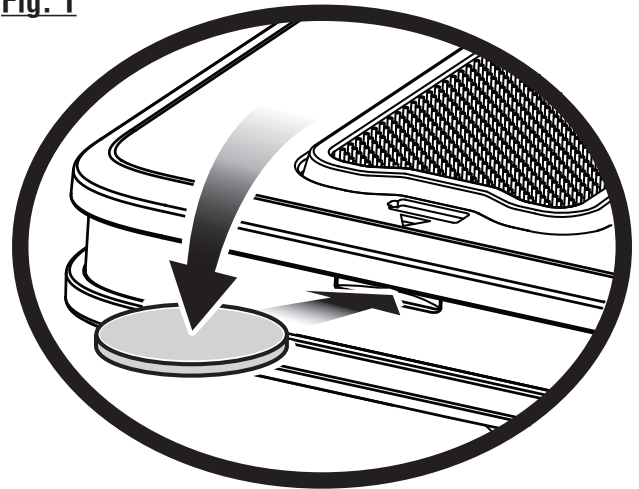

Fig. 2

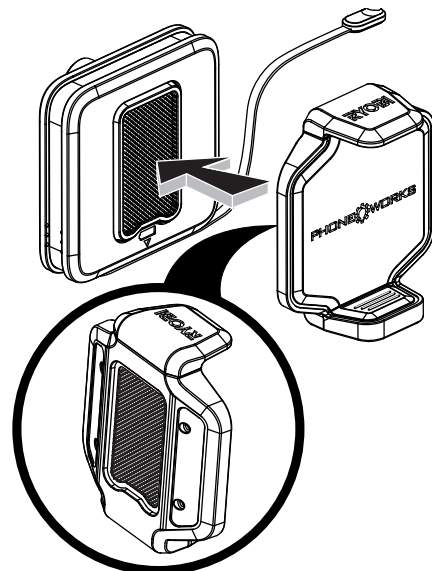
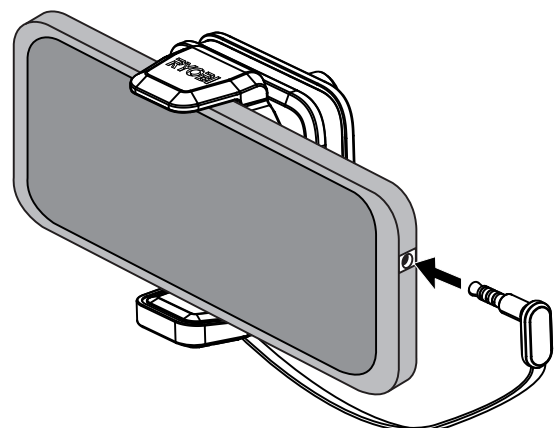

Fig. 3



OPERATION

Turn the volume on your smartphone to its maximum setting. Some phones have features that limit the amount of volume available. Turn these features off before you attempt to use the device.

For the most accurate readings:

- Place the device close to the item you wish to read. An approximate distance of less than 2 feet is recommended, but the closer you are to the target object, the more accurate your reading will be.
- Readings at distances greater than two (2) feet may be less accurate due to external light sources, surrounding air temperature and reading of larger surface areas not intended to be measured.
- Accuracy of readings of 50°-86°F (10° -30°C) is plus (+) or minus (-) 3°F (1.5°C) of the actual temperature. All other readings are +/- 1.5% of the reading.
- Cleaner surfaces will give more accurate readings.

NOTE: Temperature readings can only be measured on a target surface.

TAKING TEMPERATURE READINGS

See Figures 4 - 6.

The laser beam projects a cone shape onto the target object. The center of this area is where the temperature is measured.

- Point the laser device directly at the target object. Tap the **Laser** icon to activate the laser.

⚠ DANGER:

Avoid direct eye exposure when using the laser and do not project the laser beam directly into the eyes of others. Serious eye injury could result.

NOTE: When the laser is **ON**, a red ring appears around the laser icon. When it is **OFF**, a white ring appears around the laser icon.

- The large digits on the screen indicate the temperature of the center of the target area.
- Tap the button to take a picture. A preview image of the target object appears on the screen.
- Swipe left toward the filing cabinet to save the image. Swipe downward to delete the image.
- Two temperatures separated by a slash appear below the recorded temperature. The first represents the lowest reading since turning the laser on. The second is the highest reading while the laser has been on.
- The temperature **in large digits** represents current geographical weather conditions.
- Tap the **Laser** icon to turn the laser **OFF**.

App images may vary.

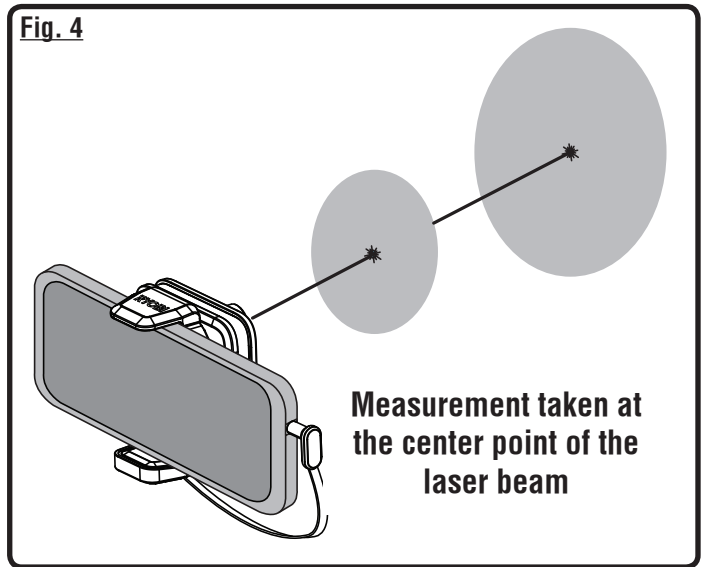

Fig. 5

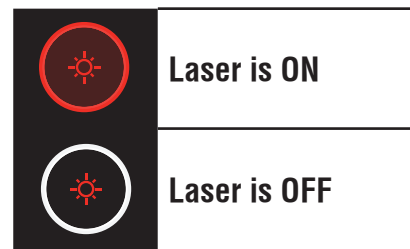
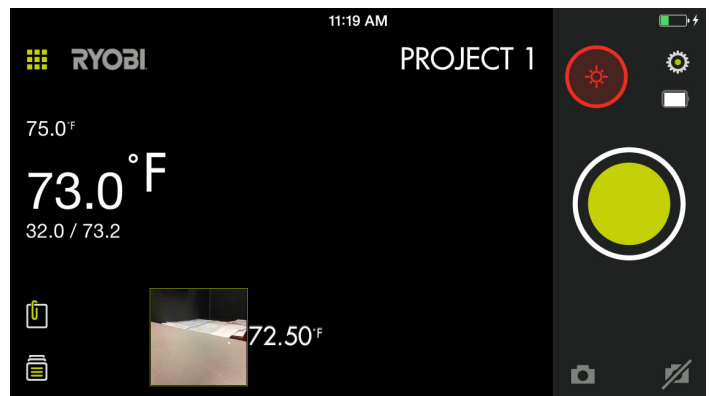

Fig. 6



OPERATION

MANAGING YOUR PROJECTS

See Figure 7.

To add, edit, delete or share your images:

Tap the project name in the top right corner. A menu appears showing **Add New**, **Edit**, **Use Existing** or **Cancel**.

Add New

- Tap **Add New** and enter the name of your new project.
- Tap **Done** to return to the screen. Any screen shots or images saved will be stored under this new project name.
- To review images, tap the file cabinet icon. Tap the image to display the saved screenshot.

NOTE: If no images have been saved, you will receive a notice that no readings are available in this project. You must save an image before you can open to review.

Edit

- Delete or add characters in the open project name and type in a new or revised name for your project.

Use Existing

- Scroll through the list of project names and select the one you wish to access.
- Tap **Done** to load the project.

CREATING NOTES

Tap the notes icon in the top right corner of the projects screen. A menu appears displaying **Photos**, **Audio Memo**, **Location** and **Notes**.

- Tap plus (+) for **Photos** to take a picture in the selected project or view current photos.
- Tap plus (+) for **Audio Memo** to record a voice memo of up to two minutes in the selected project. Tap the green button to begin recording. Tap again to stop.
- Tap plus (+) for **Location** and select **Use Current Location** to record your current location in the selected project. To edit or manually enter the location, tap plus (+) again to access the keyboard.
- Tap plus (+) for **Notes** to access the notes screen. Tap plus (+) again to access the keyboard.

SHARING NOTES

- Select the share icon .
- Select the share icon on each piece of data you wish to share.
- Select the share method.

Fig. 7

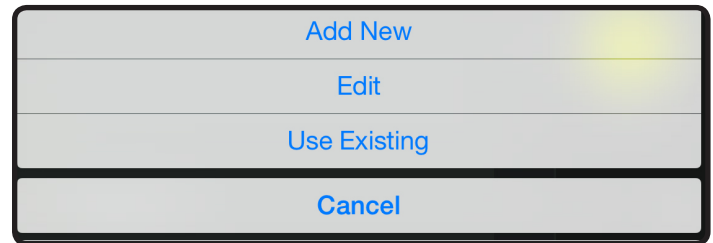

Fig. 8

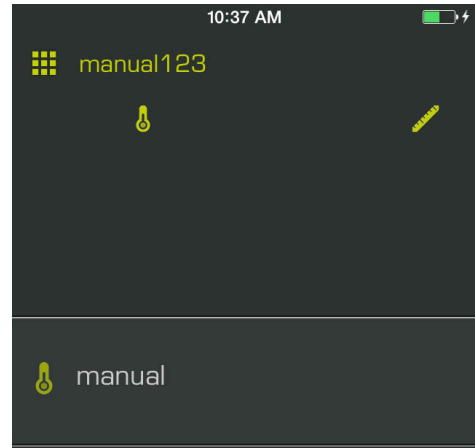

Fig. 9

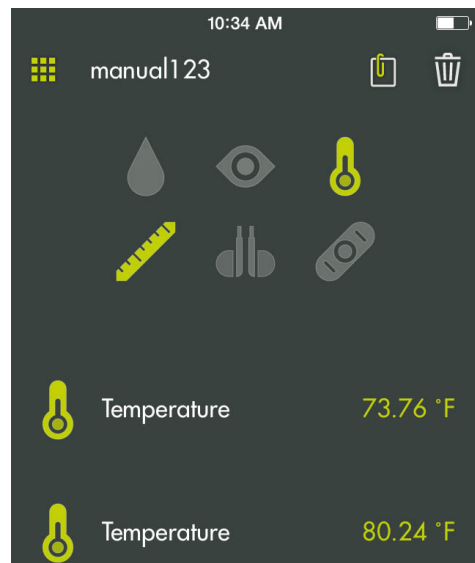

Fig. 10



App images may vary.

OPERATION

PROJECT FOLDER SUMMARY

See Figure 10.

- The file cabinet  may be accessed from the RYOBI™ Phone Works™ home screen or from any app segment.
- Accessing the file cabinet from the home screen will display all projects and icons representing the app segments used for each project.

Fig. 11



PROJECT SUMMARY

See Figures 11.

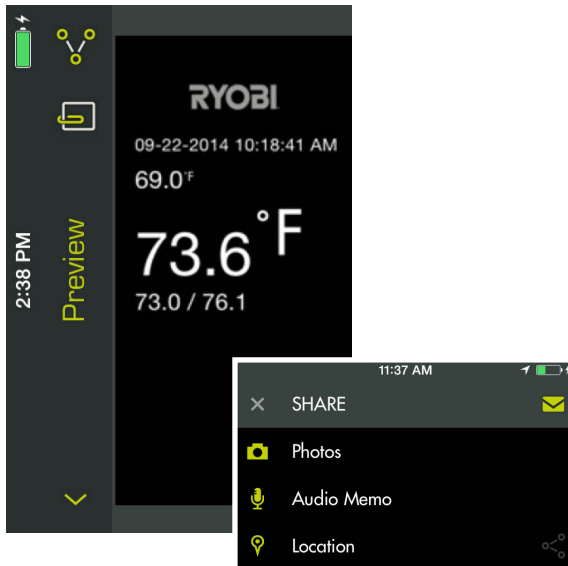
- Accessing the file cabinet from within a project will display the app segments containing photos or data.
- Tap an icon to select or deselect an app segment within a project. When an app segment is selected, stored items will be visible.
- Tap a stored item to preview its details.

SHARING PROJECTS

See Figure 12.

- To share the picture, tap the share icon () to the right of **Preview**. A blank email opens with the image attached.
- Tap **Cancel** to save the email as a draft or delete the draft. Sending the email returns you to the **Preview** screen.
- To exit preview, tap the arrow to the left of **Preview**.

Fig. 12

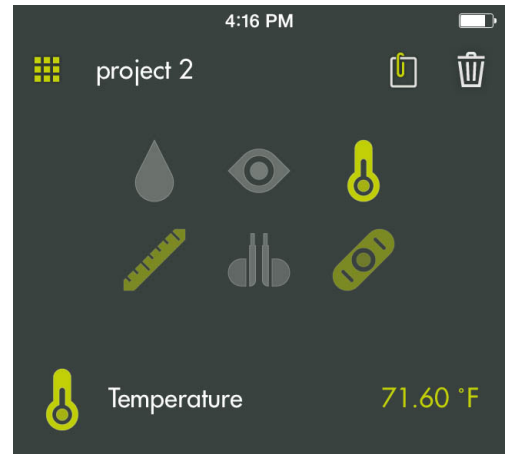
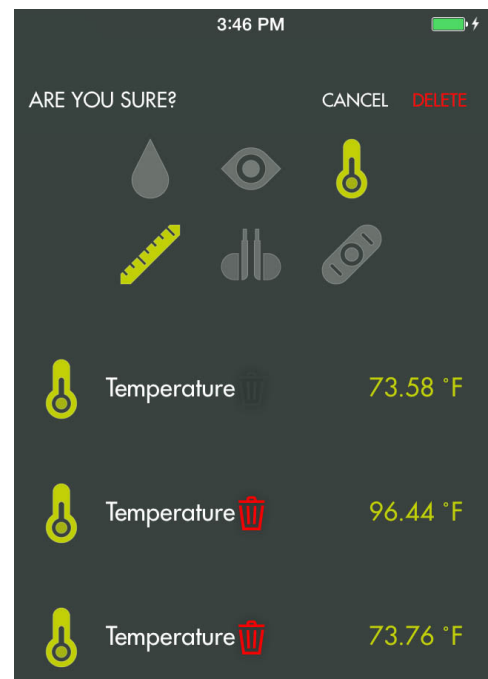

Fig. 13



App images may vary.

OPERATION

DELETING PROJECTS

See Figure 13.

- To delete a project view, tap the trash can icon. Tap the project view(s) you wish to delete. A red trash can appears next to each item you have selected to delete. Tap **DELETE**  to remove the item.
- To delete an entire project across multiple devices, return to the RYOBI™ Phone Works™ home screen. Select the file cabinet icon and then select the project you wish to delete. Swipe to reveal the **DELETE** option and select **DELETE**.

GLOBAL SETTINGS/SETTINGS

See Figure 14.

- Tap the **Settings**  icon on the RYOBI™ Phone Works™ home screen to make changes based on your preferences.
- Settings specific to some app segments can only be changed within the app segment.
- Tap **Save** to apply changes.
- You may also LOGOUT from this screen, view the Terms and Conditions, and view the Privacy Policy.

Fig. 14



App images may vary.

MAINTENANCE

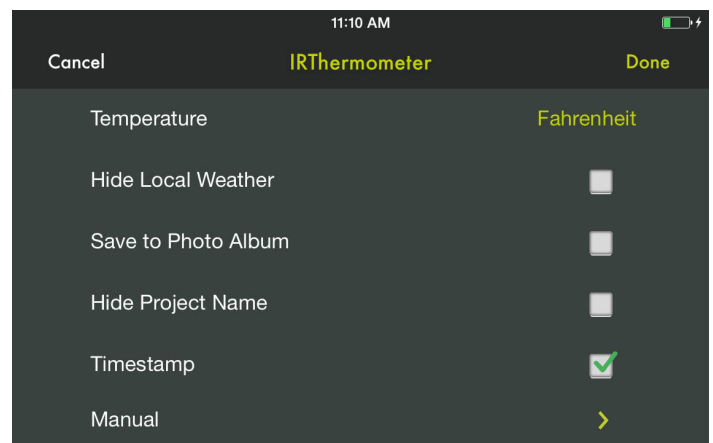
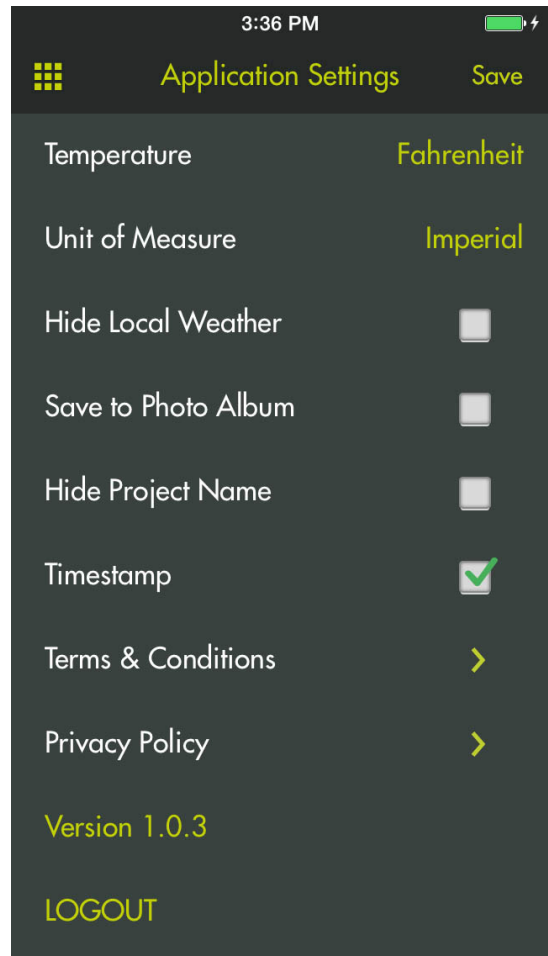
WARNING:

When servicing, use only identical replacement parts. Use of any other parts could create a hazard or cause device damage.

GENERAL MAINTENANCE

Avoid using solvents when cleaning plastic parts. Most plastics are susceptible to damage from various types of commercial solvents and may be damaged by their use. Use clean cloths to remove dirt, dust, oil, grease, etc.

STORAGE

Store in a cool, dry location to prevent condensation or mold from forming inside the device.

Do not store the device at temperatures greater than 122° F (such as on a dashboard or vehicle interior).

CALIFORNIA PROPOSITION 65

WARNING:

This device may contain chemicals, including lead, known to the State of California to cause cancer, birth defects, or other reproductive harm. ***Wash hands after handling.***

BATTERY RECYCLING

Consult the Earth 911 website (www.earth911.com) or your local waste authority for information regarding available recycling and/or disposal options.

WARNING:

Do not attempt to destroy or disassemble batteries or remove any of their components. All batteries must be recycled or disposed of properly. Do not discard large amounts of used batteries together. “Dead” batteries often have residual charge. When grouped together, these batteries can become “live” and pose a risk of possible serious injury.