

# COLFAX

## DINING TABLE

### ASSEMBLY INSTRUCTIONS

---

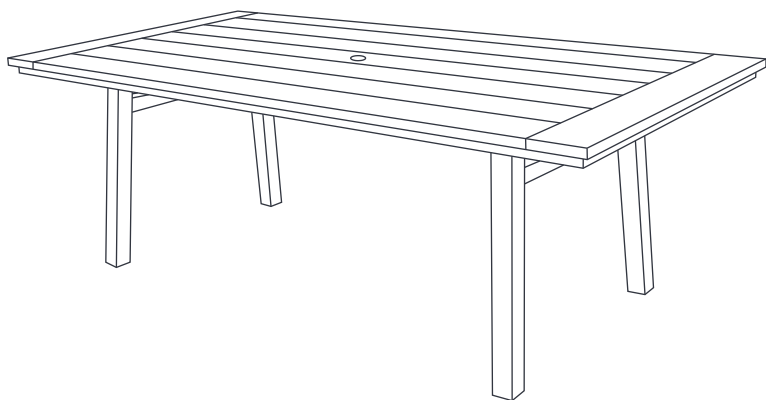

  
**BLUE OAK™**

# **BEFORE YOU BEGIN:** **YOU ALREADY KNOW THIS, BUT** **IT'S BEST TO READ ALL THE** **INSTRUCTIONS BEFORE** **ASSEMBLY. FAILURE TO DO SO** **MAY RESULT IN FAULTY** **ASSEMBLY AND POTENTIAL** **INJURY (NO ONE WANTS THAT** **KIND OF STAIN ON THEIR PARTY** **HOSTING RECORD).**



Assemble your Blue Oak™ outdoor furniture on a soft, non-abrasive surface such as a carpet or cardboard to avoid damaging the item. Seek assistance to assemble bulky or heavy items (there's no "i" in "team"). After final alignment, make sure all the bolts are securely tightened with hex caps pressed in place.

If you have issues, challenges or annoyances with this product, give us a call at 1-888-444-0367.





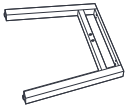
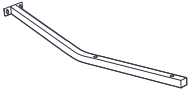

We're available from 8am-5pm (EST)

Monday-Thursday and 8am-4pm (EST) on Friday.

# PARTS

NO.	DESCRIPTION		QTY
A	Table Leg		2
B	Connector		2
C	Table Top		1
D	Umbrella Cap		1

# HARDWARE

NO.	DESCRIPTION		QTY
AA	M8x20 Bolt		4
BB	M8x40 Bolt		8
CC	M8x45 Bolt		4
DD	Lock Washer		16
EE	M8 Washer		16
FF	Bolt Head Cap		16
GG	Wrench		1

# ASSEMBLY INSTRUCTIONS

TAKE A DEEP BREATH AND KEEP A CLEAR SPOT NEARBY WHERE YOU CAN PLACE THE SMALL PIECES.

*Note: There are three sizes of hex bolts. Make sure you're using the type specified in each step. Do not fully tighten the bolts until you've completed the assembly and checked to see if the alignment is correct.*

## STEP 1

Place the table top (C) and table leg (A) on a soft, non-abrasive surface such as cardboard or a blanket.

## STEP 2

See Figure 1. Use the wrench (GG) to attach the table legs (A) to the table top (C) with 8 M8x40 bolts (BB), M8 washers (EE) and lock washers (DD).

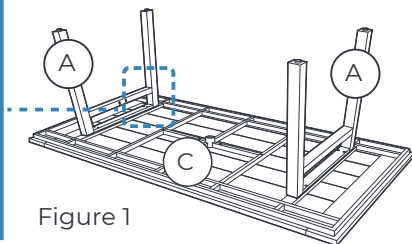
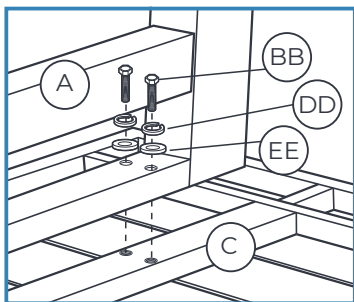

Figure 1

## STEP 3

See Figure 2. Use the wrench (GG) to attach connectors (B) to the table legs (A) with 4 M8x20 bolts (AA), M8 washers (EE) and lock washers (DD).

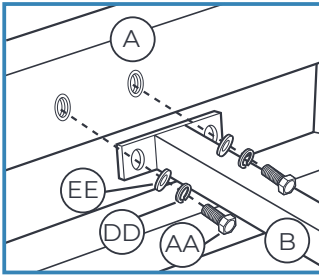
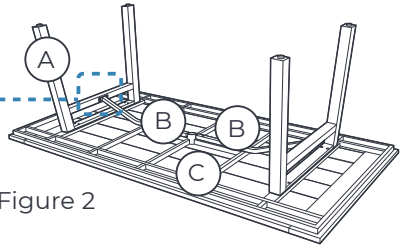

Figure 2



## STEP 4

See Figure 3. Use the wrench (GG) to attach the connectors (B) to the table top (C) with 4 M8x45 bolts (CC), M8 washers (EE) and lock washers (DD).

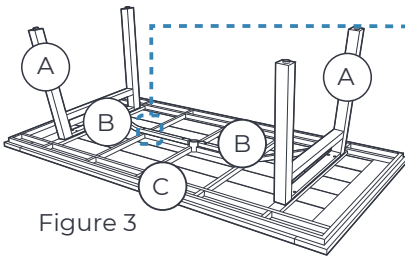
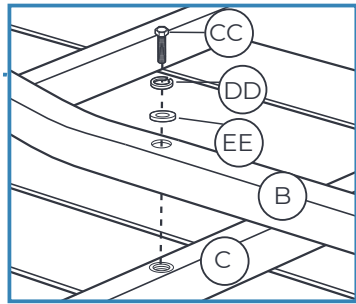

Figure 3



## STEP 5

Fully tighten all bolts and apply the bolt head caps (FF) to each bolt.

## STEP 6

Turn the table upright and place the umbrella cap (D) into the umbrella hole in the center of the table top (C).

**YOUR TABLE IS NOW READY TO USE.**

**VICTORY! GATHER FRIENDS AND FAMILY OVER A BEAUTIFUL TABLE YOU'VE PUT TOGETHER YOURSELF.**

[BLUEOAKOUTDOOR.COM](http://BLUEOAKOUTDOOR.COM)