

HOME DECORATORS COLLECTION

1002341379/103041/28WM90305-16013

1002341383/103058/28WM90305-16014

1003020690/112258/28WM90305-16018

USE AND CARE GUIDE

HIGHLAND ELECTRIC FIREPLACE

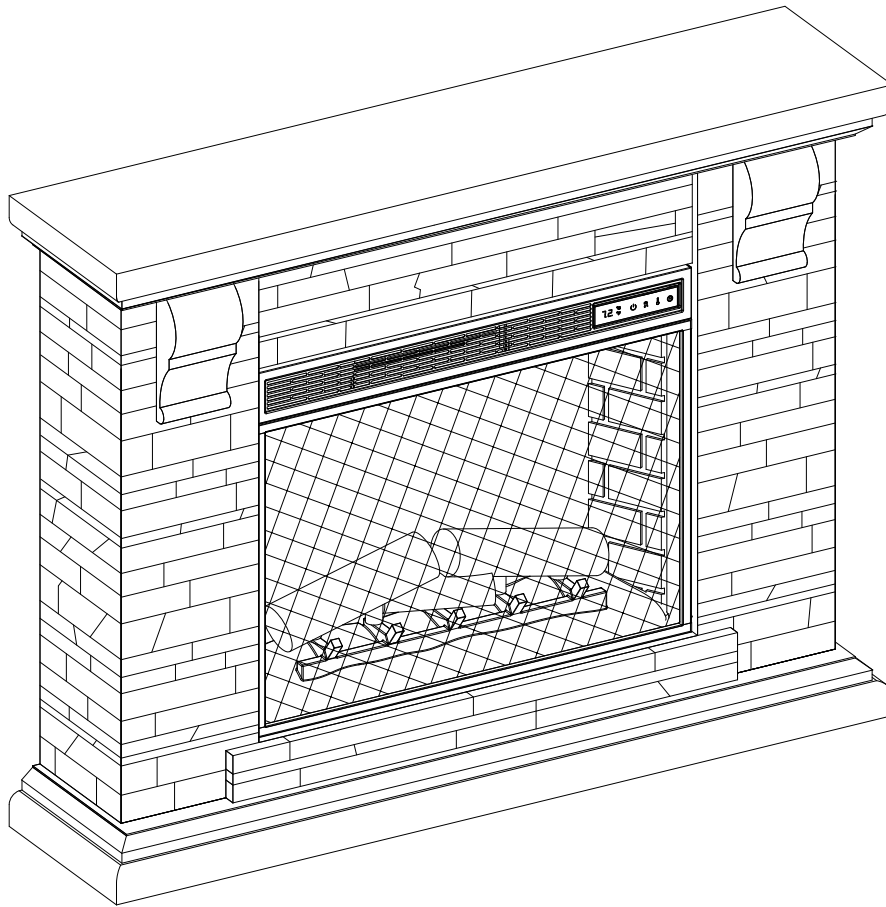

**QUESTIONS, PROBLEMS, MISSING PARTS? BEFORE RETURNING TO THE STORE,
CALL HOME DECORATORS COLLECTION CUSTOMER SERVICE
8 A.M. - 7 P.M., EST, MONDAY - FRIDAY, 9 A.M. - 6 P.M., EST, SATURDAY**

1-800-986-3460

HOMEDEPOT.COM/HOMEDECORATORS

THANK YOU

We appreciate the trust and confidence you have placed in Home Decorators through the purchase of this electric fireplace. We strive to continually create quality products designed to enhance your home. Visit us online to see our full line of products available for your home improvement needs. Thank you for choosing Home Decorators!

Table of Contents

Safety Information.....	3	Operation	9
Warranty	5	FCC/IC Information.....	11
Pre-Assembly.....	6	Care & Cleaning.....	11
Hardware Included	6	Troubleshooting.....	12
Product Specifications.....	6	Replacement Parts.....	14
Tools Required	6		
Assembly.....	7		

Maximum Load Warning

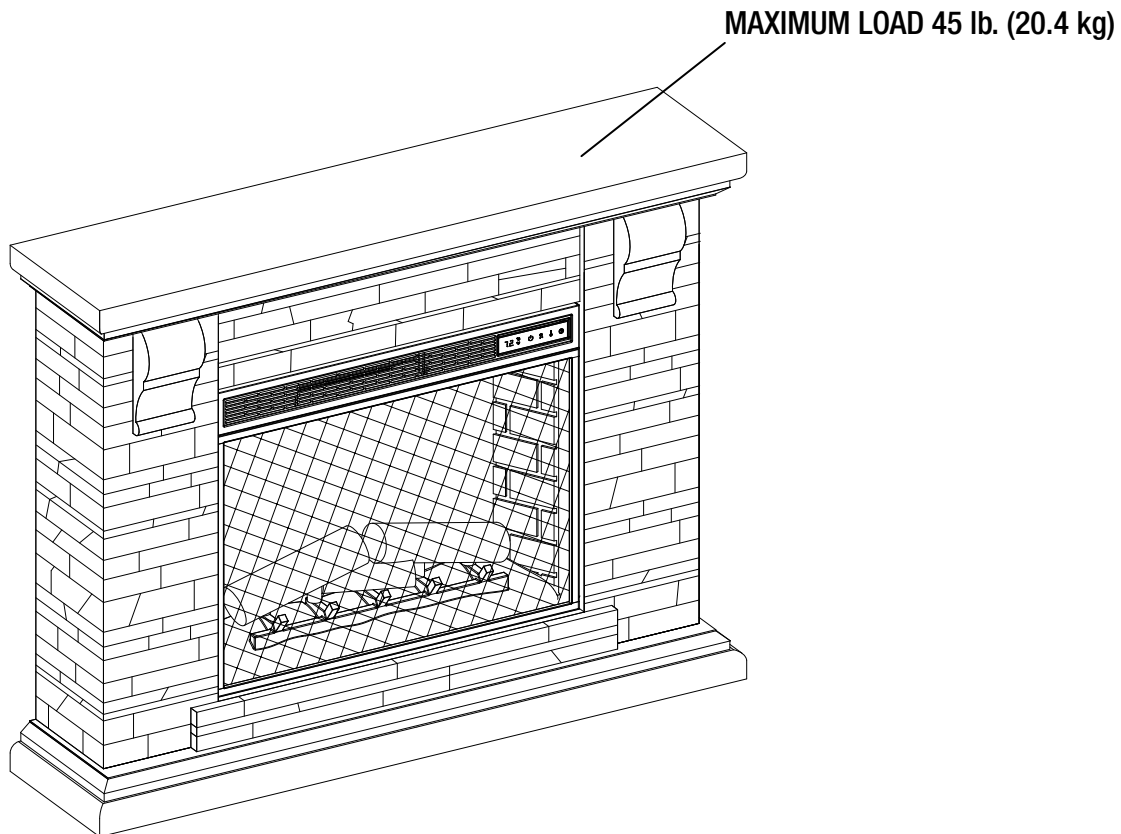

CAUTION: This unit is intended for use only with the products and maximum weights indicated. Use with other products or products heavier than the maximum weights indicated may result in instability causing possible injury.

Safety Information

Please read and understand this entire manual before attempting to assemble, operate or install the product. If you have any question regarding the product, please call customer service at 1-800-986-3460, 8 a.m.-7 p.m., EST, Monday-Friday, 9 a.m. - 6 p.m., EST, Saturday.

When using electrical appliances, basic precautions should always be followed to reduce the risk of fire, electrical shock, and injury to persons including the following:

1. Read all instructions before using this appliance.
2. If possible, always unplug this appliance when not in use.
3. Only a qualified service person should repair this product.
4. Do not use outdoors.
5. Do not cover the cord under the carpeting. Do not cover with throw rugs, runners or the like. Arrange the cord away from traffic areas and where it will not be tripped over.
6. To disconnect this appliance, turn the controls to the off position, and then remove the plug from the outlet.
7. Connect to properly grounded outlets only.
8. This appliance, when installed, must be electrically grounded in accordance with local codes or, in the absence of local codes, with the current CSA C22.1 Canadian Electrical Code. For U.S.A. installations, follow local codes and the National Electrical Code, ANSI/NFPA NO.70.
9. This appliance has hot and arcing or sparking parts inside. Do not use it in areas where gasoline, paint or flammable liquids are used or stored. This fireplace should not be used as a drying rack for clothing. Do not hang Christmas stockings or other decorations on or near this product.
10. There is a thermostat limiter inside the heater. When inner temperature overheating or abnormal heating occurs, the thermostat protective device will cut off the power supply to avoid damage to the fireplace or risk of fire.

 **DANGER:** High temperatures may be generated under certain abnormal conditions. Do not partially or fully cover or obstruct the front of this heater.

 **WARNING:** In order to avoid overheating, do not cover the heater.

 **WARNING:** If the supply cord is damaged, it must be replaced by the manufacturer, its service agent or similarly qualified persons in order to avoid a hazard.

 **WARNING:** Under no circumstances should this fireplace be modified. Parts that must be removed for servicing must be replaced prior to operating this fireplace again.

 **WARNING:** This heater may include a visual alarm to warn that parts of the heater are getting excessively hot. If the alarm illuminates, immediately turn the heater off and inspect for any objects on or adjacent to the heater that may have blocked the airflow or otherwise caused high temperatures to have occurred. **DO NOT OPERATE THE HEATER WITH THE ALARM ILLUMINATING.**

 **WARNING:** This appliance is not a toy. Supervise children playing near it.

 **WARNING:** Use extreme caution when operating heater near children and the disabled.

 **WARNING:** This heater is not intended for use in bathrooms, laundry areas and similar indoor locations. Never locate this appliance where it may fall into a bathtub or other water container.

 **WARNING:** Do not insert or allow foreign objects to enter any ventilation or exhaust opening as this may cause an electric shock or fire, or damage the appliance.

 **WARNING:** To prevent a possible fire, do not block air intakes or exhaust in any manner. Do not use on soft surfaces, like a bed, where the opening may become blocked.

 **WARNING:** Use this appliance only as described in the manual. Any other use not recommended by the manufacturer may cause fire, electric shock or injury to persons.

 **WARNING:** This appliance has hot and arcing or sparking parts inside. Do not use it in areas where gasoline, paint or flammable liquids are used or stored. This fireplace should not be used as a drying rack for clothing. Do not hang Christmas stockings or other decorations on or near this product.

 **CAUTION:** Never leave the heater operating unattended. Extreme caution is necessary if unsupervised children or invalids are nearby.

 **CAUTION:** Before assembly, carefully use scissors or a utility knife to cut and unwrap all parts. Make sure you do not discard the hardware.

Safety Information (continued)



NOTE: Use care in assembling your new fireplace. Take your time and use the hardware provided and a quality Phillips head screwdriver. Never overtighten bolts.

- Do not sit on any part of the mantel.



NOTE: To avoid injury from unexpected starting or electrical shock, do not plug the power cord into a source of power during unpacking and assembly. The cord must remain unplugged whenever you are adjusting/assembling the fireplace.

If any part is missing or damaged, do not attempt to use or plug in the power cord until the missing or damaged part is correctly replaced. To avoid electric shock, use only identical replacement parts when servicing double-insulated tools.



NOTE:

**SAVE THESE
INSTRUCTIONS**

Warranty

1 Year Limited Warranty: The manufacturer warrants that your new Electric Fireplace is free from manufacturing and material defects for a period of one year from date of purchase, subject to the following conditions and limitations.

1. Install and operate this appliance in accordance with the installation and operating instructions furnished with the product at all times. Any unauthorized repair, alteration, willful abuse, accident, or misuse of the product shall nullify this warranty.
2. This warranty is non-transferable, and is made to the original owner, provided that the purchase was made through an authorized supplier of the product.
3. The warranty is limited to the repair or replacement of part(s) found to be defective in material or workmanship, provided that such part(s) have been subjected to normal conditions of use and service, after said defect is confirmed by the manufacturer's inspection.
4. The manufacturer may, at its discretion, fully discharge all obligations with respect to this warranty by refunding the wholesale price of the defective part(s).
5. Any installation, labor, construction, transportation, or other related costs/expenses arising from defective part(s), repair, replacement, or otherwise of same, will not be covered by this warranty, nor shall the manufacturer assume responsibility for same.
6. The owner/user assumes all other risks, if any, including the risk of any direct, indirect or consequential loss or damage arising out of the use, or inability to use the product, except as provided by law.
7. All other warranties – expressed or implied –with respect to the product, its components and accessories, or any obligations/liabilities on the part of the manufacturer are hereby expressly excluded.
8. The manufacturer neither assumes, nor authorizes any third party to assume on its behalf, any other liabilities with respect to the sale of the product.
9. The warranties as outlined within this document do not apply to non accessories used in conjunction with the installation of this product.
10. This warranty gives you specific legal rights, and you may also have other rights which vary from state to state.

This warranty is void if:

- a. The fireplace is subjected to prolonged periods of dampness or condensation.
- b. Any unauthorized alteration, willful abuse, accident, or misuse of the product.
- c. You do not have the original receipt of purchase.

Pre-Assembly

HARDWARE INCLUDED

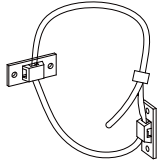

AA



BB

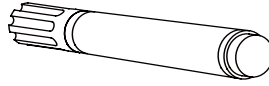

ZZ

Part	Description	Part Number	Quantity
AA	Tipping Restraint Hardware	PH-BKTWHT003	2
BB	Insert Mounting Bracket (pre-attached)	PH-BKTZNC001	4
ZZ	Touch-up Pen	N/A	1



NOTE: Hardware not shown to actual size.

PRODUCT SPECIFICATIONS

VOLTAGE	120VAC, 60 Hz
AMPS	12.5 Amps
WATTS	1500 Watts

PLANNING ASSEMBLY

Before beginning assembly of product, make sure all parts are present. Compare parts with Hardware Included and Package Contents lists. If any part is missing or damaged, do not attempt to assemble, install or operate the product. Contact customer service for replacement parts.

Estimated Assembly Time: 10 Minutes

TOOLS REQUIRED



Phillips Screwdriver

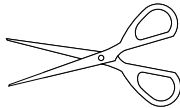

Scissors

Assembly

1 Unpacking the fireplace insert

- Using scissors, cut the rope securing the fireplace insert.

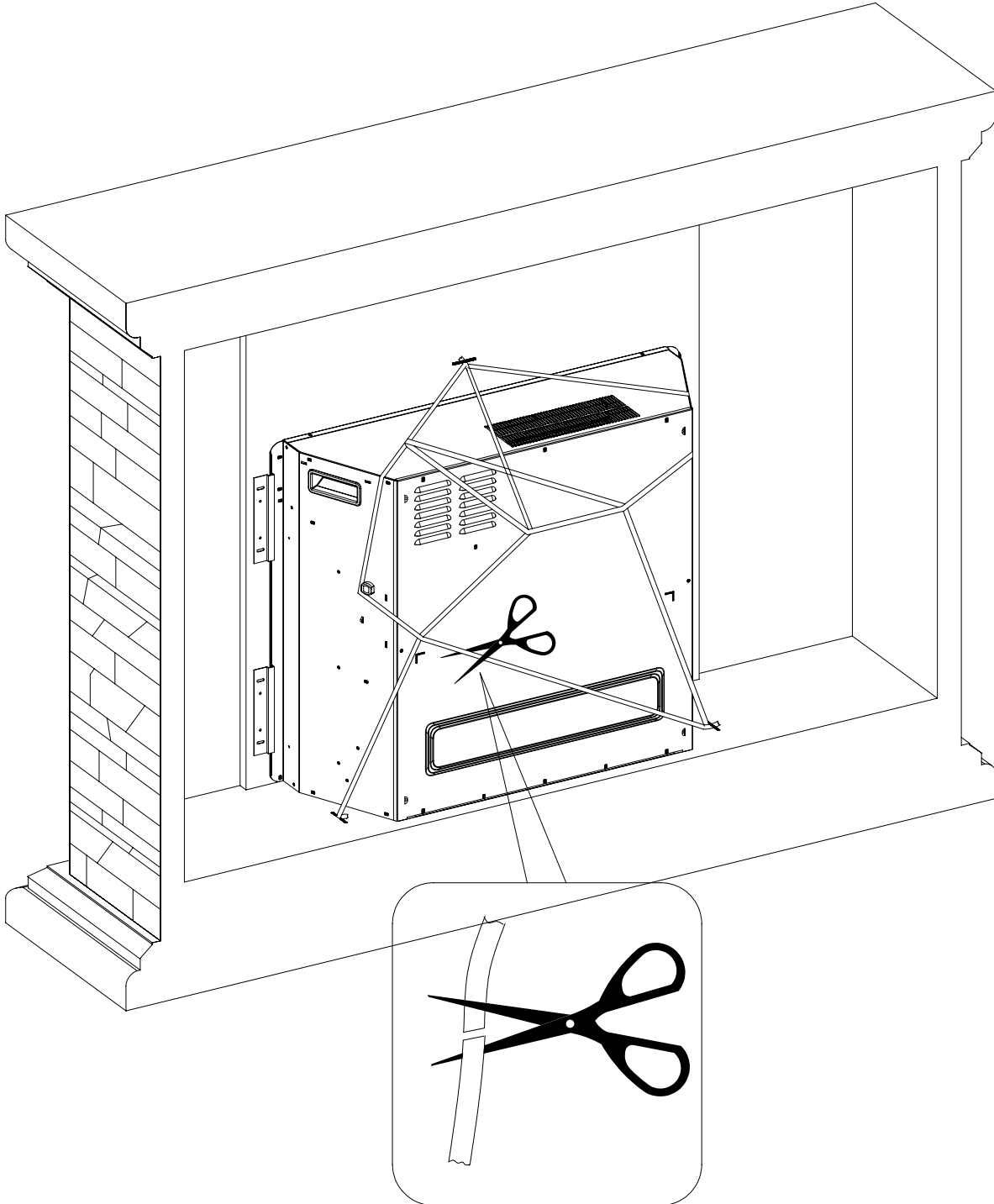

Assembly (continued)

2 Installing the tipping restraint hardware

- When the Tipping Restraint Hardware (AA) is properly installed, it can provide protection against unexpected tipping of the Unit due to small tremors, bumps or climbing.
- Your Unit comes with two Tipping Restraint Hardware (AA). Each Tipping Restraint Hardware (AA) includes one Unit Anchor, one Wall Anchor, one Anchor Tether, and four Anchor Screws. Use these to complete the following steps for a proper installation.
- Locate a secure wall stud behind the unit closest to left side.
- Align the Unit Anchor with a wall stud and attach with two Anchor Screws using a Philips Head Screwdriver. The Anchor Screws must pass through the Top Electric Fireplace for proper installation.
- Align the Wall Anchor in the center of the wall stud, at level with the Unit Anchor, and attach with two Anchor Screws using a Philips Head Screwdriver.
- On the Anchor Tether, detach the cable from the connector and loop the loose cable through the eyelets on the Wall Anchor and Unit Anchor. Reattach the loose cable to the connector, but do not tighten.
- Locate a secure wall stud behind the unit closest to the right side, and repeat the steps above.
- Tighten both Anchor Tethers by pulling the cable the through connector.

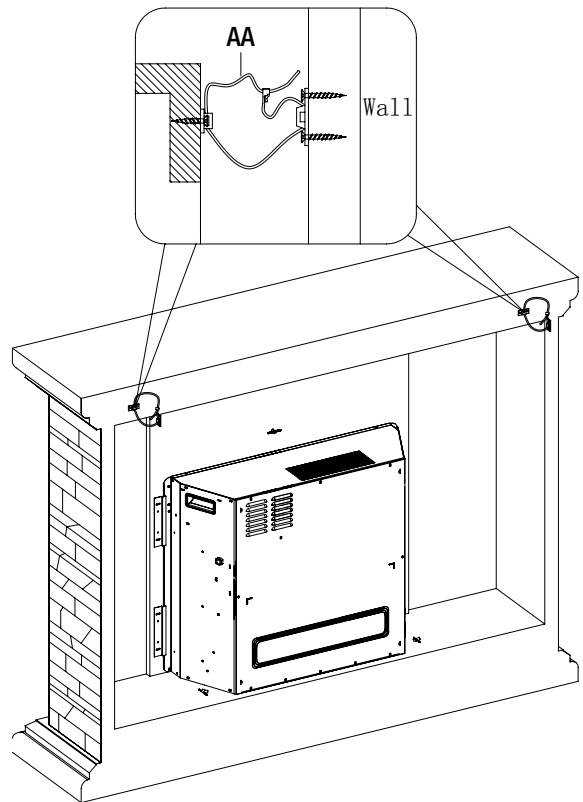

NOTE: Installation of the Tipping Restraint Hardware (AA) will provide a small space between the wall and the unit. This will allow you to run power cords and connector cables to your television or other devices placed on top of the unit.



WARNING: Installing the Tipping Restraint Hardware will help prevent accidents or damage to the unit.

Operation



NOTE: The control panel can be accessed at the upper-right corner of the insert.

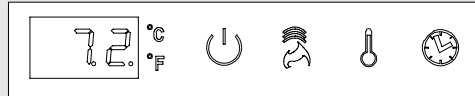

1 Powering the fireplace

- Push the Power button to supply power to all functions of the fireplace and put the insert in a standby mode.
- Push the Power button again to turn off all functions.



NOTE: All previous settings are held in memory, so the next time you power up the fireplace, the unit will turn on with the same settings.



NOTE: Holding the Power button on the control panel for 10 seconds will disable the heater function.



2 Adjusting the flame

- There are 6 brightness levels that can be selected:

Settings F6 - F4 decrease in Amber brightness

Settings F3 - F1 decrease in Spectrafire brightness



3 Adjusting the heater

- Press the Heater button to set the thermostat. The fireplace contains three infrared quartz heating elements. The thermostat setting range is 62°F - 82°F or 17°C - 27°C or always ON. The thermostat is adjustable by 2°F or 1°C increments. The up and down buttons “+” / “-” on the remote will increase / decrease temperature setting.



NOTE: To change between °F and °C press and hold the HEATER button on the control panel for 3 seconds.



4 Setting the timer

Pressing the Timer button will cycle through the timer settings; 30 minutes, 1 Hour, 2H, 3H, 4H, 5H, 6H, 7H, 8H, 9H and off.



Operation (continued)

5 Replacing the remote control battery

- When the remote control stops operating or its range seems reduced, it is time to replace the battery with new ones.
- On the back end of the remote, press and slide the battery door open and remove the old battery.
- Insert 2 AAA batteries, checking that the + and - sides of the battery match inside the battery compartment.
- Replace the battery compartment door.



NOTE: Do not mix old and new batteries. Do not mix alkaline, standard (carbonzinc), or rechargeable (nicad, nimh, etc) batteries. Do not ingest batteries.



NOTE: Please operate the remote control at a slow measured pace. Press the remote control buttons with an even motion and gentle pressure. Repeatedly pressing buttons in rapid succession may cause the transmitter to malfunction.



NOTE: Batteries should be removed if the product is to be left unused for a long time.

6 Disposing of used batteries

- The battery may contain hazardous substances that could endanger the environment and human health.
- This symbol marked on the battery and/or packaging indicates that used battery shall not be treated as municipal waste. Instead it shall be left at the appropriate collection point for recycling.
- By correctly disposing used batteries, you prevent potential negative consequences for the environment and human health. Recycling used materials also conserves natural resources.
- For more information about collecting and recycling used batteries, please contact your local municipality, your waste disposal service or the point of sale where you purchased this product.

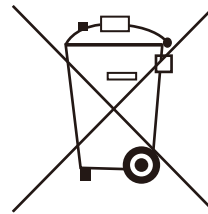

7 Power cord information

- This heater is for use on 120 volts. The cord has a plug as shown in the figure.
- Connect to properly grounded outlets only.
- Do not use a 2 prong adapter. Never use with an extension cord or relocatable power tap (outlet/power strip).

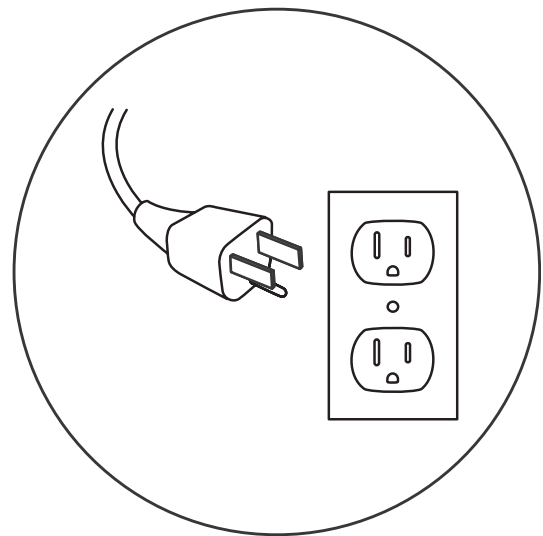

FCC/IC Information



WARNING: Changes or modifications to this unit not expressly approved by the party responsible for compliance could void user's authority to operate the equipment.



NOTE: This equipment has been tested and found to comply with the limits for Class B digital device, pursuant to part 15 of the FCC Rules. These limits are designed to provide reasonable protection against harmful interference in a residential installation. This equipment generates, uses, and can radiate radio frequency energy and, if not installed and used in accordance with the instructions, may cause harmful interference to radio communications. However, there is no guarantee that interference will not occur in a particular installation. If this equipment does cause harmful interference to radio or television reception, which can be determined by turning the equipment off and on, the user is encouraged to try to correct the interference by one or more of the following measures:

- Reorient or relocate the receiving antenna.
- Increase the separation between the equipment and the receiver.
- Connect the equipment into an outlet on a circuit different from that to which the receiver is connected.
- Consult the dealer or an experienced radio/TV technician for help.

This device complies with Part 15 of the FCC Rules. Operation is subject to the following two conditions:

- (1) This device may not cause harmful interference, and
- (2) this device must accept any interference received, including interference that may cause undesired operation.

This Class B digital apparatus complies with Canadian ICES-003.

Care and Cleaning

- Dust your fireplace regularly with a soft non-lint-producing cloth or household dusting product.
Clean your fireplace with a gentle non-abrasive household cleaner. Dry your fireplace immediately with a soft cloth or towel.
- Tips for using touch-up pen (ZZ): For scratches, stroke in direction of scratch. For worn areas, stroke in direction of wood grain. Rub excess colorant promptly with a soft cloth.
- The motors used on the fan and the flame generator assembly are pre-lubricated for extended bearing life and require no further lubrication. However, we recommend periodic cleaning/vacuuming of the fan/heater.
Make sure the unit is turned OFF and unplugged whenever you are cleaning the heater or fireplace.



WARNING: Make sure the power is turned off before proceeding with repairs. Any electrical repairs or rewiring of this unit should be carried out by a licensed electrician in accordance with national and local codes. If repairing or replacing any electrical component or wiring, the original wire routing, color coding and securing locations must be followed. During any service of this appliance, the power to the unit must be turned off. First turn the main power switch to the OFF position. Then remove the electrical plug from the wall outlet.



WARNING: Electrical outlet wiring must comply with local building codes and other applicable regulations to reduce the risk of fire, electrical shock and injury to persons.



WARNING: Do not use this fireplace if any part of it has been under water. Immediately call a qualified service technician to inspect the fireplace and replace any part of the electrical system.



WARNING: Disconnect power before attempting any maintenance or cleaning to reduce the risk of fire, electrical shock or personal injury.

Troubleshooting

PROBLEM	ROOT CAUSE	CORRECTIVE ACTION
Display shows "E 1"	The thermostat sensor is broken or disconnected.	Unplug the fireplace, remove the back panel of the fireplace and check that the thermostat is plugged into the main circuit board. If this does not solve the problem contact customer service for a replacement thermostat sensor.
Display shows "E 2"	The thermostat sensor is broken.	Contact customer service for a replacement thermostat sensor.
Display shows "E 3"	Manual Reset overheat protection has triggered.	Inspect the heater and check that the air inlets and outlets are not blocked as this may cause overheating. Unplug the heater for 30 minutes and allow it to cool down. Replug and operate. Monitor the heater for signs of overheating. If the problem persists, discontinue use of the heater and contact customer service.
Display shows "E r"	This is normal operation.	Check your heater cord and plug connections. Faulty wall outlet connections or loose plugs can cause the outlet or plug to overheat. Be sure the plug fits tight in the outlet. Heaters draw more current than small appliances. Overheating of the outlet may occur even if it has not occurred with the use of other appliances. During use check frequently to determine if your plug outlet or faceplate is HOT! If so, discontinue use of the heater and have a qualified electrician check and/or replace the faulty outlet(s).
Heater does not blow warm air.	The heater is in a cool down cycle.	Normal operation will continue to run for several minutes before shutting down. Times will vary based on temperatures. During this time cool air will blow.
There is no power and the logs do not glow.	There is no power to the unit.	Check that the unit is plugged into a standard 120V outlet. Press the Power button several times and make sure power is set to the "ON" position.
The logs glow, but there is no flame effect.	The flame effect turned off.	Press the flame button several times.
The heater does not blow warm air.	Thermostat setting is preventing the heater from turning on.	Adjust the temperature settings to ensure that the thermostat is set higher than the current room temperature.

Troubleshooting (continued)

PROBLEM	ROOT CAUSE	CORRECTIVE ACTION
Flame effect works but heater function does not and the embered flashes when the heater button is pressed.	The heater is disabled.	With the power on press and hold the POWER button on the control panel for 10 seconds. Once re-enabled the embered lights will flash multiple times.
The remote control is not working.	There are no batteries.	Change the remote batteries.
	The signal is poor.	Operate remote transmitter at a slow measured pace. Press the remote control buttons with an even motion and gentle pressure. Repeatedly pressing buttons in rapid succession may cause the transmitter to malfunction.
	The remote is too far from the heater.	Operate the remote at a distance less than 20 ft from the front of the appliance; point the remote at the control panel.

Replacement Parts

For replacement parts, call our customer service department at 1-800-986-3460, 8 a.m.-7 p.m., EST, Monday-Friday, 9 a.m. - 6 p.m., EST, Saturday.

Part	Description	Qty.
1	Remote Control	1
2	Flame Circuit Board	1
3	Blue LED Circuit Board	1
4	Flame Generator Drive Motor	1
5	Thermostat Sensor	1
6	Blower/ Heater Assembly	1
7	Control Panel Circuit Board	1
8	Front Panel with Frame	1
9	Emberbed with Logset	1
10	Emberbed Circuit Board	1
11	Main Circuit Board	1

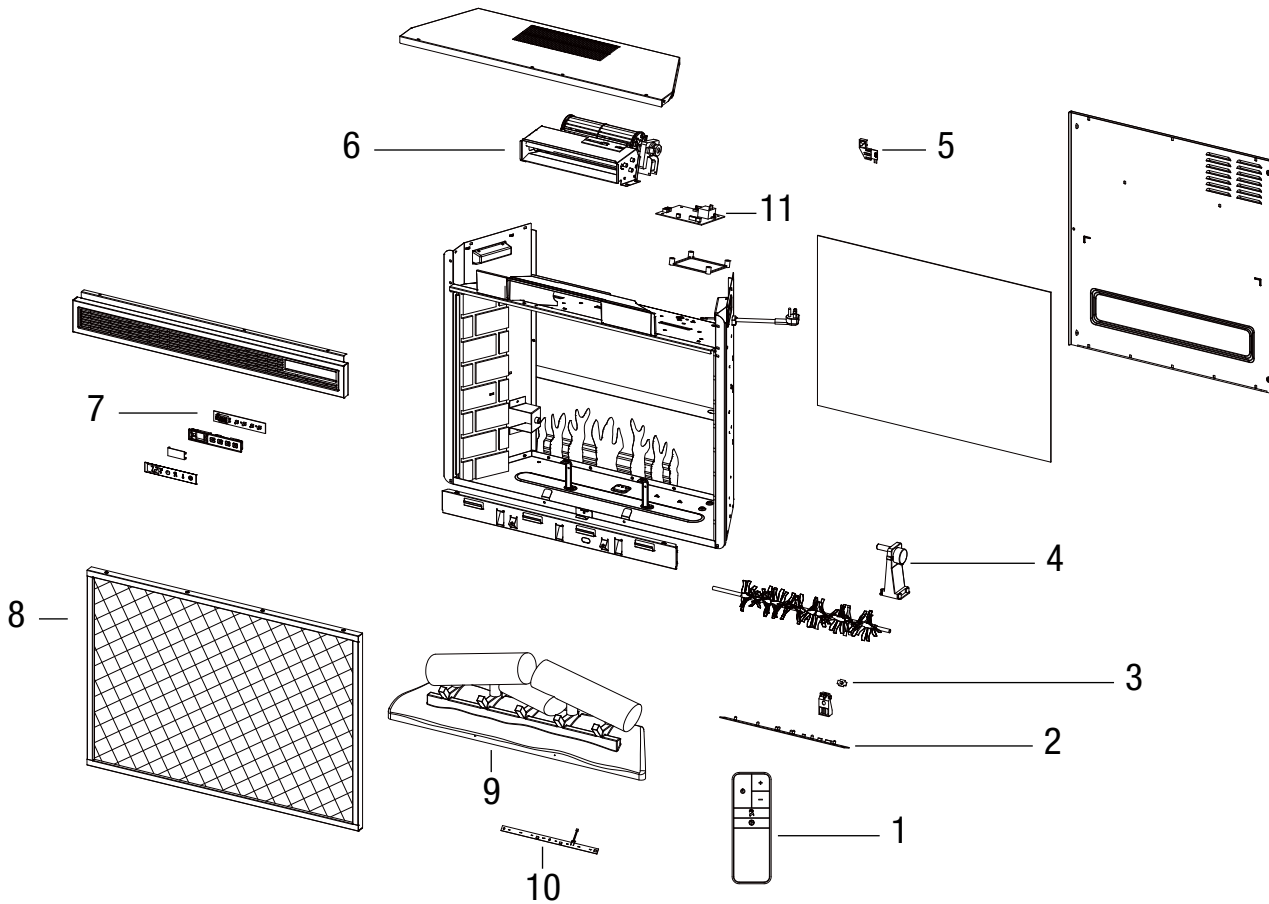

HOME DECORATORS COLLECTION

Questions, problems, missing parts? Before returning to the store call
Home Decorators Customer Service

8 a.m. - 7 p.m., EST, Monday - Friday, 9 a.m. - 6 p.m., EST, Saturday

1-800-986-3460

HOMEDEPOT.COM/HOMEDECORATORS

RETAIN THIS MANUAL FOR FUTURE USE.