

Replacement Parts

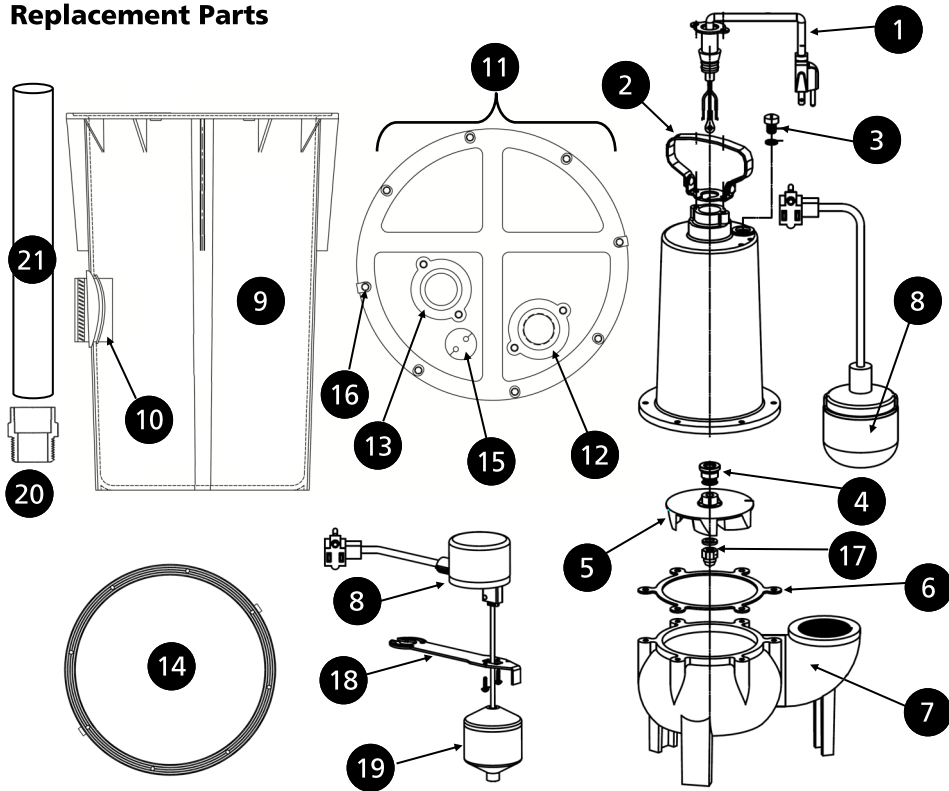

INSTALLATION & OPERATION MANUAL

SIMPLEX SEWAGE PUMP KIT Models: 93015, 93020

Ref#	Description	Part # 93015	Part # 93020
1	Power Cord	99108	99108
2	Pump Handle	99053	99053
3	Oil Fill Plug (Includes O-ring)	99056	99056
4	Shaft Seal	99057	99057
5	Impeller (Includes nut & washer)	99095	99095
6	Gasket	99091	99091
7	Volute	99097	99097
8	Float Switch (92010 includes float switch, float rod, float ball and grommet)	92000	92010
9	18" x 30" Structural Foam Basin	99300-T	99300-T
10	Inlet Hub with Stainless Steel Clamp	99302	99302
11	Cover (Includes PVC seal, vent & discharge flanges, cord grommet & bolts)	99315	99315
12	2" Threaded Vent Flange (Includes O-ring)	PVT200	PVT200
13	2" Discharge Flange (Includes O-ring)	PDS200	PDS200
14	PVC Seal	SEAL18-8	SEAL18-8
15	Cord Grommet	GROM11-2	GROM11-2
16	1/4" x 1" Stainless steel bolts for cover (qty 8)	99808	99808
17	Stainless Steel Nut & Washer (M6)	99164	99164
18	Vertical Float Switch Bracket	n/a	99105
19	Float Switch Ball	99170	99170
20	2" PVC Male Adapter	99540	99540
21	2" PVC Pipe - 30" Long	99542	99542

*If motor fails, replace entire pump

Customer Support
1-800-495-9278
2301 Traffic St. NE
Minneapolis, MN 55413

Safety Guidelines

Carefully read, understand and follow all safety instructions in this manual.

 This is the safety alert symbol. When you see this symbol, look for one of the following signal words.

 **DANGER** Indicates a hazardous situation which, if not avoided, will result in death or serious injury.

 **CAUTION** Indicates a hazardous situation which, if not avoided, could result in death or serious injury.

 **WARNING** Indicates a hazardous situation which, if not avoided, could result in minor or moderate injury.

Safety Information

Read these warnings carefully. Know the application and limitations of this pump. Failure to follow these warnings could result in serious bodily injury and/or property damage.

 **DANGER** RISK OF ELECTRICAL SHOCK. Disconnect and lockout the power supply before removing the old pump or installing or servicing this pump.

 **DANGER** RISK OF ELECTRICAL SHOCK. This pump is supplied with a grounding conductor and grounding type attachment plug. To reduce the risk of electric shock, be certain that it is connected only to a properly grounded, grounding type receptacle. **DO NOT UNDER ANY CIRCUMSTANCE REMOVE THE GROUNDING PIN FROM THE PLUG.** For added safety, it is highly recommended to connect this pump to a GFCI (Ground Fault Circuit Interrupter) outlet.

 **WARNING** The installation of this pump must be in accordance with the National Electric Code (NEC), Uniform Plumbing Code (UPC), International Plumbing Code (IPC) as well as all applicable local codes and ordinances.

 **CAUTION** Do not install this pump in any location classified as hazardous by the National Electrical Code, ANSI/NFPA70.

 **CAUTION** Do not use this pump to pump flammable or explosive fluids such as gasoline, kerosene, etc. Do not use this pump in flammable or explosive environments. Use only with liquids compatible with pump component materials.

 **WARNING** RISK OF ELECTRICAL SHOCK. This pump has not been investigated for use in swimming pool or marine areas.

 **WARNING** Sewage pumps handle materials that can cause illness or disease. Wear protective clothing when installing or servicing a pump in an existing installation.

 **WARNING** RISK OF ELECTRICAL SHOCK. **DO NOT** use the power cord to remove or lower the pump into the basin. The cord may pull apart exposing bare wires which could cause a fire or electrical shock. Use the handle supplied with the pump for installing and removing the pump from the basin.

 **WARNING** Do not run the pump dry. This pump relies on water for cooling. Running the pump dry can cause the pump to overheat and the possibility of burns to anyone that handles the pump. Running the pump dry will void the warranty.

Troubleshooting

Problem	Possible Causes	How to Correct
If the pump does not start or run	Pump is not plugged in, switch or breaker is turned off	Plug pump in or turn on switch/breaker
	Check for blown fuses or tripped circuit breakers or tripped GFCI outlets	Replace fuse, reset breaker, reset GFCI outlet
	Float switch is defective	Check and replace if necessary
	Motor thermal protector tripped	Allow pump to cool. Pump will reset automatically
	Float switch is stuck or obstructed	Remove obstruction or position pump so it will not become stuck
The pump cycles too frequently or runs periodically when fixtures are not in use.	Backflow of water from discharge pipe	Install or replace check valve
	Float switch is defective	Replace float switch
	Fixtures are leaking	Repair Fixtures to eliminate leakage
If the pump runs but moves little or no water	Obstructed discharge hose/pipe	Remove obstruction
	Frozen discharge hose/pipe	Allow hose/pipe to thaw
	Pump is air locked	Remove
	Low line voltage	Check wire size and increase if necessary
	Check valve is stuck in the closed position or defective	Inspect, repair or replace if necessary
	Check valve is installed backwards	Make sure valve is installed in the correct direction of flow
	Worn, damaged or clogged pump parts	Inspect for wear, damage or clog and clean or replace part if necessary
	Discharge head exceeds pump capacity	If pumping height is over 25', the pump will not move water. See performance chart
Pump does not shut off	Float switch is obstructed or stuck	Remove obstruction
	Defective Float Switch	Replace float switch

Performances

Height and/or piping restriction will reduce the pump output performance. It is recommended to use the same size or larger pipe as the pump discharge for optimum performance.

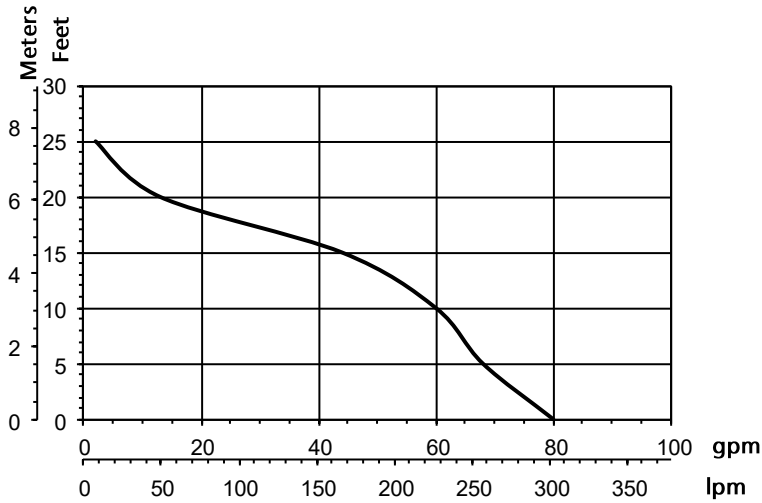

Discharge Height	0'	5'	10'	15'	20'	25'
	(0 m)	(1.5 m)	(3.0 m)	(4.6 m)	(6.1 m)	(7.6 m)
Gallons Per Minute	80	68	60	44	13	2
Liters Per Minute	303	257	227	167	49	8

Specifications

Model	93015	93020
HP	1/2	1/2
Volts	120 volt AC	120 volt AC
Amps	7.6 Amps	7.6 Amps
Hz	60 Hz	60 Hz
Phase	1	1
Circuit Requirements	15 Amp (min)	15 Amp (min)
Pump Discharge Size	2" NPT	2" NPT
Max. Solids Handling	2" Spherical	2" Spherical
Max. Liquid Temperature	120°F	120°F
Float Switch Type	Wide angle tethered	Vertical
Cut in (Pump on) Level (Factory Set)	16"	11"
Cut-out (Pump off) Level (Factory Set)	8"	4"
Cord Length	10'	10'
Pump Construction	Cast Iron	Cast Iron
Impeller	Stainless Steel Vortex	Stainless Steel Vortex
Motor Shaft	Stainless Steel	Stainless Steel
Shaft Seal	Carbon/Ceramic/Stainless Steel	Carbon/Ceramic/Stainless Steel
Basin Material	HDPE structural foam	HDPE structural foam
Cover Material	HDPE structural foam	HDPE structural foam
Cover Gasket	Reusable PVC Seal	Reusable PVC Seal
Basin Inlet Size	4"	4"
Basin Vent & Discharge Size	2"	2"

Dimensions

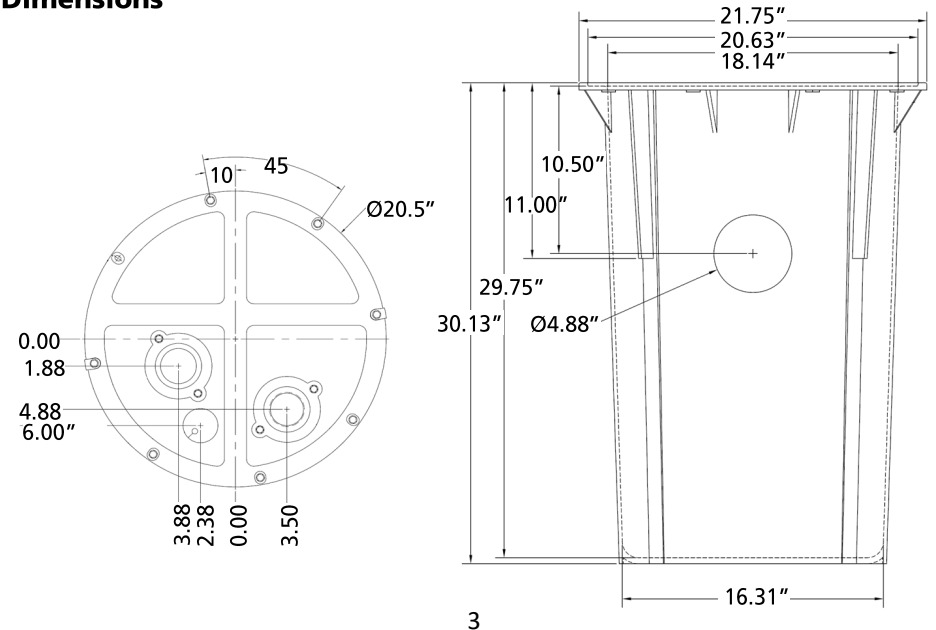

Installation

Piping & Basin

Piping must not be smaller than the pump discharge, in this case 2". The pipe must be capable passing solids of at least 2" in diameter. To meet minimum flow requirements, size the pipe as follows.

A pipe size of :	Will Handle a Flow Rate of
2"	21 GPM
2-1/2"	30 GPM
3"	48 GPM

1. Before installation, check the pump and pipe inside the basin for damage that may have occurred during shipping.
2. Dig a hole for the basin (if necessary). The hole should be approximately 24" larger in diameter and 12" deeper than the basin size to provide adequate room for the sub-base & backfill. Backfill and sub-base should be 1/8" to 3/4" pea gravel or crushed stone.
3. Install the basin on top of the sub-base making sure the basin is level. If necessary, level the top of the basin level with the finished floor.
4. Insert the 4" inlet pipe through the inlet hub . **NOTE:** To aid in installation, use liquid soap to lubricate the pipe and hub. Bevel or file the sharp edges of the pipe to prevent damage to the hub. Insert the pipe approximately 2" into the basin and secure by tightening the stainless steel clamp. The pipe should pitch downward to the basin by approximately 1/4" per foot to allow water to run into the basin.
5. Backfill around the basin with crushed stone or pea gravel.

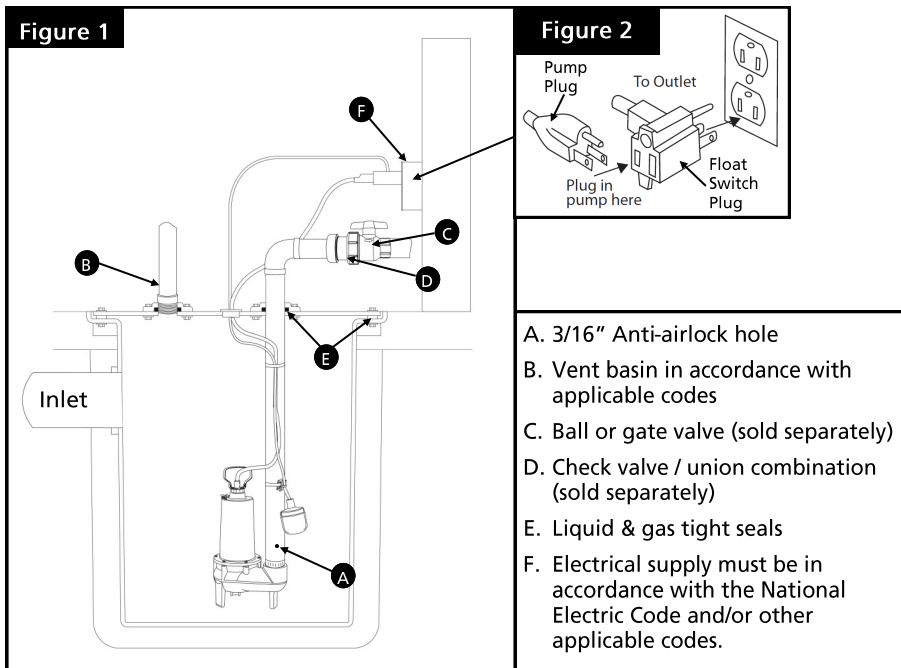

Installation (continued)

6. Install a 2" vent pipe into the 2" NPT threaded vent flange (B). Connect the vent pipe to the existing vent pipe or run the pipe through the roof of the building. The sewage basin **MUST** be vented in accordance with all local codes. .
7. Install a 2" full flow check valve (C) (sold separately) onto the discharge pipe to prevent backflow into the basin. The check valve should be a full flow type and be capable of handling 2" solids. Install the check valve with the flow direction arrow pointing in the direction of flow. For best performance, do not install the check valve more than 45° above the horizontal as solids may accumulate in the valve and prevent it from opening upon pump startup. It is recommended to use a union and check valve/ball valve combination to allow for easy removal of the pump. Install per the check valve manufacturer's installation instructions.
8. Connect the remaining discharge pipe from the check valve / ball valve to the septic tank, sewage line, etc., using the shortest length of pipe and fewest number of turns as possible.

Alarm

The use of an alarm (sold separately) is recommended to warn of a high-water condition resulting from pump and/or control malfunction. The power supply for the alarm should be on a separate circuit so that a circuit interruption to the pump will not affect the alarm circuit.

Operation

1. Plug the piggy-back plug of the float switch into a 120 volt grounded outlet. See Figure 2. The use of a GFCI is strongly recommended. Plug the pump plug into the back of the piggy-back float switch plug. **NOTE:** If connecting the pump and float switch to a control panel, follow the manufacturers instructions for proper installation
2. Check the installation by filling the basin and observing the pump operation through several complete cycles. Make any necessary adjustments at this time.

Maintenance

1. The pump should be checked on a regular basis for proper operation.
2. Periodically inspect and clean the anti-airlock hole.
3. Inspect the float switch for any accumulated debris that may inhibit it from operating properly. Clean if necessary.
4. The pump has sealed, permanently lubricated bearings and requires no additional lubrication.