

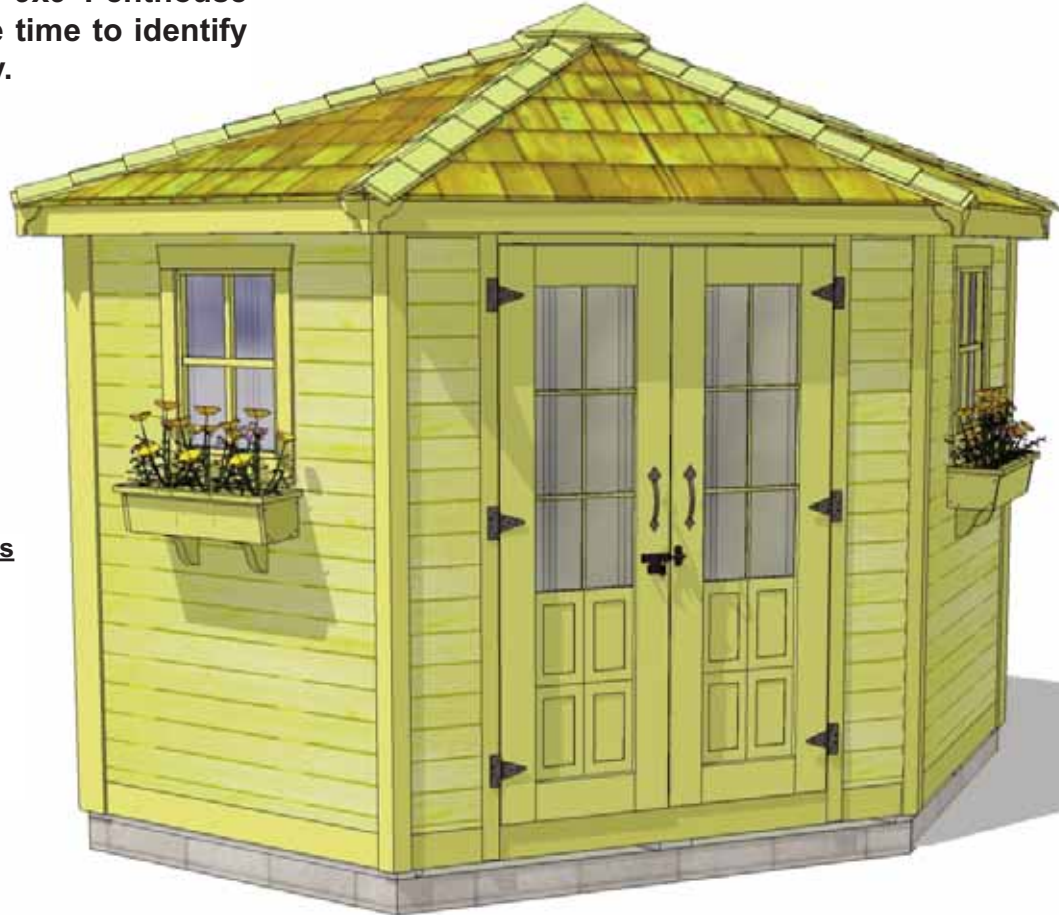

# 9x9 Penthouse Garden Shed Assembly Manual

Version #19  
January 10, 2019

Thank you for purchasing a 9x9 Penthouse Garden Shed. Please take the time to identify all the parts prior to assembly.



## Safety Points and Other considerations

Our products are built for use based on proper installation and normal residential use, on level ground. Please follow the instruction manual when building your shed and retain the manual for future maintenance purposes.

Some of the safety and usage measures you may wish to consider include:

- snow load ratings vary by geographical location. If heavy or wet snowfall occurs, it is advisable to sweep the snow off the roof(s).
- if the product is elevated, any structural and building code requirements are solely the customer's responsibility, and should be abided by.
- in high or gusty wind conditions it is advisable to keep the structure securely grounded.
- have a regular maintenance plan to ensure screws, doors, windows and parts are tight.

Customer agrees to hold Outdoor Living Today Partnership and any Authorized Dealers free of any liability for improper installation, maintenance and repair.

**In the event of a missing or broken piece, simply call the Outdoor Living Today Customer Support Line @ 1-888-658-1658 within 30 days of the delivery of your purchase. It is our commitment to you to courier replacement parts, free of charge, within 10 business days of this notification. Replacement parts will not be provided free of charge after the 30 day grace period.**

**Thank you for purchasing our 9x9 Penthouse Garden Shed.  
Please take the time to identify all the parts prior to assembly.**

## **Parts List:**

### **A. Floor Section (Optional)**

- 18 - 1 1/2" x 3 1/2" x 52 1/2" Joists (Rectangular Sec.)
- 12 - 1 1/2" x 3 1/2" x 27 3/4" Joist Plates (Rect. Sec.)
- 1 - 1 1/2" x 3 1/2" x 78 1/2", 53 3/8", 51 7/8" Perimeter Joist (Tri. Sec.)
- 1 - 1 1/2" x 3 1/2" x 38 3/4" Interior Joist (Tri. Sec.)
- 1 - 1 1/2" x 3 1/2" x 24 3/4" Interior Joist (Tri. Sec.)

- 3 - 5/8" x 41 1/2" x 55 3/8" Plywood Flooring
- 1 - 5/8" x 27 5/8" x 55 3/8" Plywood Flooring
- 1 - 5/8" x 27 5/8" x 55 3/8" Plywood Flooring (angle cut in corner)
- 1 - 5/8" x 41 1/2" x 41 1/2" Plywood Flooring - Triangular Shape
- 3 - 1 1/2" x 3 1/2" x 69 1/2" Floor Runners
- 3 - 1 1/2" x 3 1/2" x 41 1/2" Floor Runners
- 1 - 1 1/2" x 3 1/2" x 41 1/2" Floor Runners (angle on one end)
- 1 - 1 1/2" x 3 1/2" x 57 1/4" Floor Runners (angle on one end)
- 1 - 1 1/2" x 3 1/2" x 44" Floor Runners (angle on one end)

### **B. Wall Section**

- 6 - 35" x 75" Solid Wall Panels (Bottom Plates Unattached)
- 6 - 1 1/2" x 2 1/2" x 35" Bottom Wall Plates
- 2 - 51" x 75" Window Wall Panels
- 2 - 12" x 73" Narrow Wall Panels
  
- 3 - 3 1/2" x 3 1/2" x 75" Corner Posts
- 2 - 3" x 3" x 2 1/4" x 75" Front Corner Posts (Wedge Shaped)

#### **Door Jambs & Header**

- 2 - 1 1/2" x 3 1/8" w x 73" Vertical Door Jamb
- 1 - 2" x 3" x 76 3/4" Door Header (1 1/2" thick with 1/2" cleat attached)
- 1 - 1 1/2" x 3" x 49 3/4" Upper Door Stop (profile dado)
- 1 - 3/4" x 2 1/8" x 49 3/4" Threshold Door Stop
- 2 - 1/2" x 2 1/8" x 70 7/8" Vertical Door Stops
- 2 - French Doors
- 1 - 1/2" x 2 1/2" x 70" Center Door Stop

#### **Top Wall Plates**

- 4 - 1 1/2" x 2 1/2" x 55 1/2" Rear Wall Top Plates (45 deg.cut /1 end)
- 2 - 1 1/2" x 2 1/2" x 55" Side Wall Top Plates (45 deg.cut / 2 ends)
- 1 - 1 1/2" x 2 1/2" x 76 1/2" Front Wall Top Plates (45 deg.cut / 2 ends)

### **C. Rafter Section**

- 1 - 3 1/2" diameter x 8" high Core Block - (1" Alignment marked on it)
- 3 - 1 1/2" x 3 1/2" x 90 9/16" Hip Rafters with Cleats (22.5 Degree cut)
- 2 - 1 1/2" x 3 1/2" x 68 3/8" Front Hip Rafters with Cleats (left and right)  
(30 Degree cut at each end & 45 degree bevel cut on one end)
- 1 - 1 1/2" x 3 1/2" x 53 1/4" Front Mid Rafter with Cleats - angle cut ends
- 2 - 1 1/2" x 3 1/2" x 68" Rear Mid Rafter with Cleats - angle cut ends
- 3 - 1 1/2" x 3 1/2" x 36 1/2" Corner Rafter- Left  
(30 degree cut 1 end - 45 & 30 degree cut on other end)
- 3 - 1 1/2" x 3 1/2" x 36 1/2" Corner Rafter- Right  
(30 degree cut 1 end - 45 & 30 degree cut on other end)

#### **Temporary Support Beam for Rafters / Core Block**

- 2 - 1 1/2" x 3 1/2" x 51 7/8" Support Beams
- 2 - 5/8" x 3 1/2" x 24" Plywood Support Cleats
- 1 - 5/8" x 5 1/2" x 5 1/2" Plywood Base

### **D. Roof Section**

- 1 - Left Front Panel
- 1 - Right Front Panel
- 1 - Left Side Panel
- 1 - Right Side Panel
- 2 - Left Rear Panels
- 2 - Right Rear Panels

### **E. Miscellaneous Section**

#### **Bottom Skirting**

- 1 - 1/2" x 4 1/2" x 79 1/2" Front (Doorway)
- 2 - 1/2" x 4 1/2" x 55 1/2" Sides
- 6 - 1/2" x 4 1/2" x 34 3/4" Rear

#### **Soffits (approx. 1" over length/ piece- cut to fit)**

- 2 - 1/2" x 4 1/2" x 39" Front Wall
- 12 - 1/2" x 4 1/2" x 28" Sides / Rear

#### **Corner & Sidewall Trim**

- 6 - 1/2" x 2 1/2" w x 79" Rear wall Seam and Doorway Trim
- 3 - 1/2" x 4 1/2" w x 79" Side/ Rear Corner Trim
- 3 - 1/2" x 5" w x 79" Side/ Rear Corner Trim
- 2 - 1/2" x 5" w x 79" Front Corner "V" Shaped
- 1 - 1/2" x 2 1/2" w x 49 3/4" Above Door Trim
- 2 - 1/2" x 2 1/2" w x 10" Narrow Wall Trim

#### **Facia & Detail Plates**

- 4 - 3/4" x 4" x 60" Rear Side Facia
- 2 - 3/4" x 4" x 59 3/4" Side Facia
- 1 - 3/4" x 4 x 85 3/4" Front Facia
  
- 3 - 1/2" x 4" x 8" Side/Rear 90 degree Corner
- 2 - 1/2" x 4" x 8" Front Corners 45 degree
- 2 - 1/2" x 4" x 8" Rear Sides -Flat

#### **Filler Shingles (5 1/2" wide) / Ridge Caps & Peak Cap**

- 14 pcs -16" Long
- 2 pcs - 14" Long
- 1 pc - 11" Long
  
- 54 - Cedar Shingle Ridge Caps (Lefts and Rights)
- 1 - 10" wide Roof Peak Cap

#### **Misc. Pieces**

- 2- Window Inserts
- 2- Window Trim Pkgs - (1 - 24 1/16" top / 3 - 23" bottom & sides)
- 2- Flower Box Kit
- 1 pc - Spare Wall Siding
- 2 pcs - Spare Shingles- use to shim door, etc

**Note: All Trim and Skirting pieces are graded best face rough.  
This means the rough side will be exposed when completing these Sections.**

# 9X9 PENTHOUSE HARDWARE PACKAGE

## Hardware Kit (Provided)

3"  x 28

1"  x 40  
Black Headed

2 1/2"  x 350

1 1/2"  x 328  
Finishing

2"  x 14

1 1/2"  x 150  
Shingle

2"  x 20  
Black Headed

1 1/4"  x 314

 x 2  
Square Drive Bit



Tee Hinge x6



Door Handle (2)



Barrel Bolt



Simpson Strong Tie (28)



Cane Bolt

## Tools Required (Not Provided)



Hammer



Screw Gun/Drill



Tape Measure



Wood Clamp



Utility Knife



Level



Pliers



Ladder



1/8" & 9/16" Drill Bits

## Safety Equipment Required (Not Provided)



Safety Glasses



Work Gloves

# A. Floor Section (Optional)

Exploded view of all parts necessary to complete Floor Section. Identify all parts prior to starting. Floor Footprint is 111" x 111" x 55 1/2" x 55 1/2" x 78 1/2".

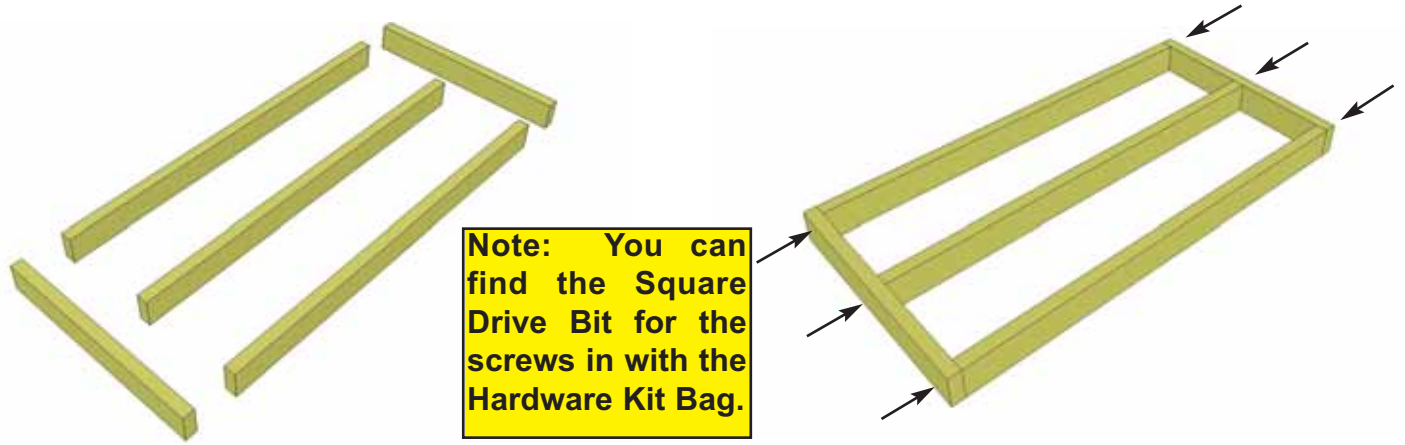
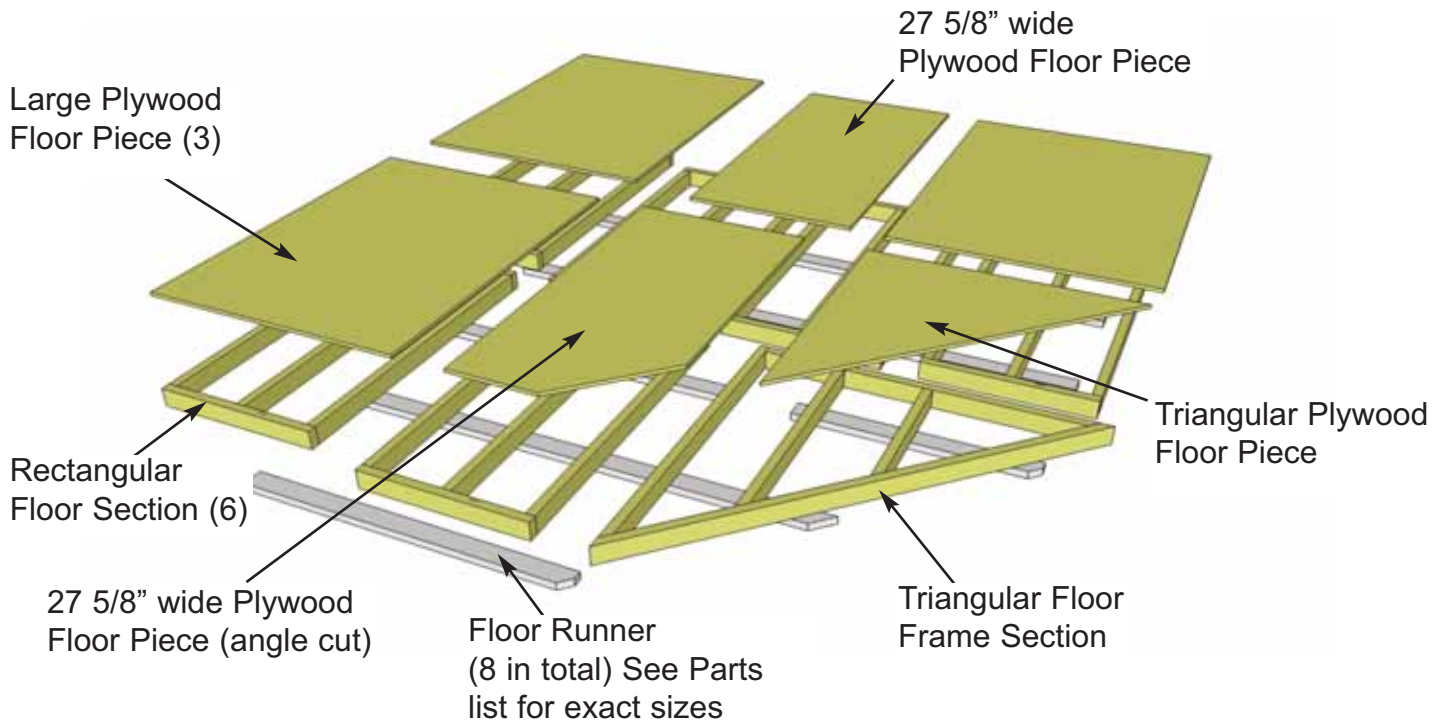

**1.** Lay out 3 - Long Floor Joists (52 1/2") and 2 Floor Joist Plates (27 3/4") as illustrated above. Position outside joists flush to end of Joist Plate. Position mid Joist equally on Joist Plate. Attach with 2 - 2 1/2" screws per end. Complete 6 Rectangular Floor Frame Sections.

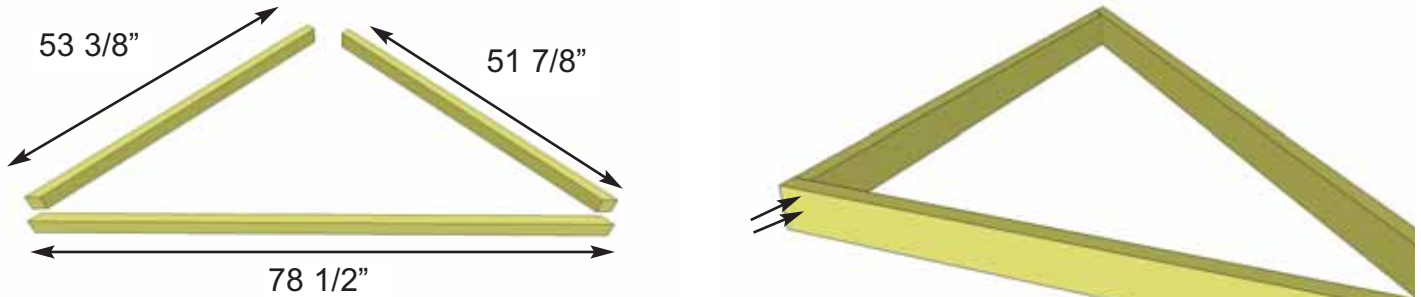

**2.** Lay out perimeter pieces for Triangular Floor Section. Attach in each corner with 2 - 2 1/2" screws. When attached together, the perimeter will be 55 1/2" x 55 1/2" x 78 1/2".

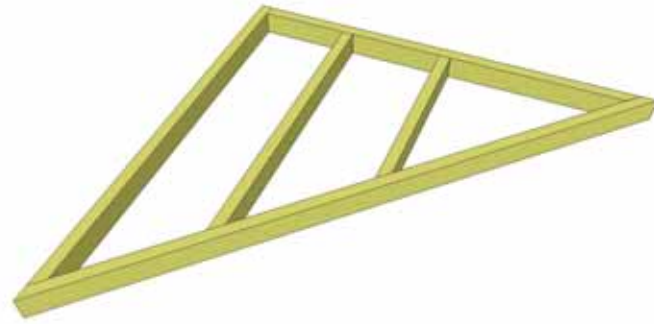
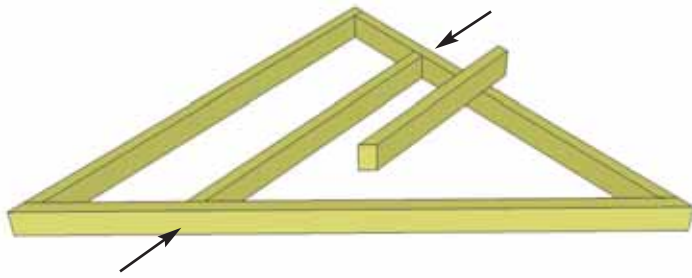

**3.** Place Interior Floor Joists (38 3/4" & 24 3/4") so both are tight against perimeter joists and attach with 2 - 2 1/2" screws per end.

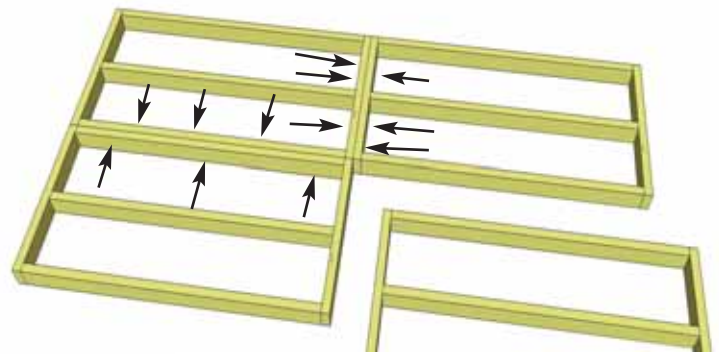
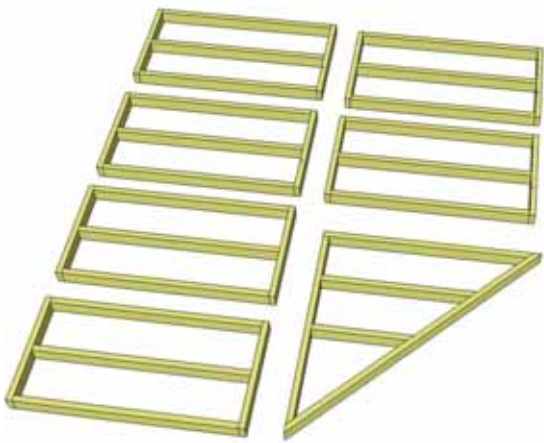

**4.** Lay out completed **Floor Joist Frame Sections** as illustrated above.

**5.** Attach Rectangular Section together with 6 - 2 1/2" screws per section.

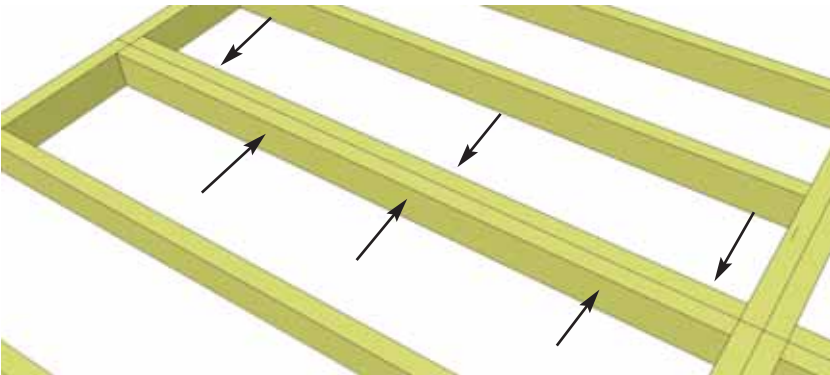

**6.** Complete all Rectangular Sections as per **Step 5**.

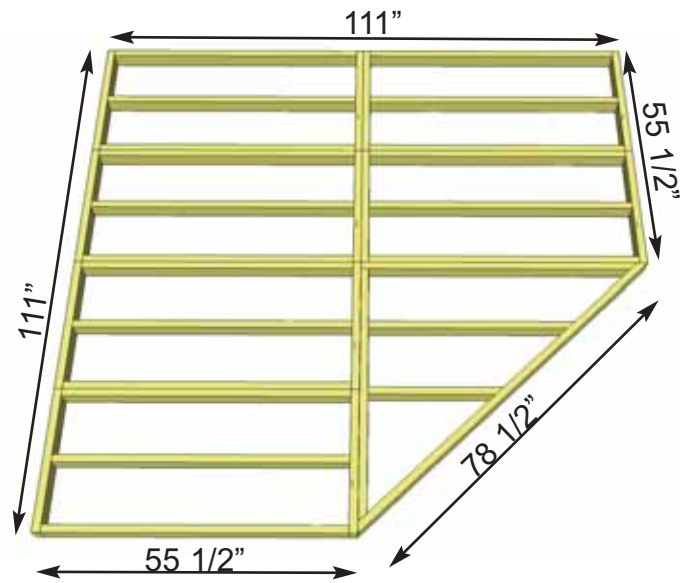
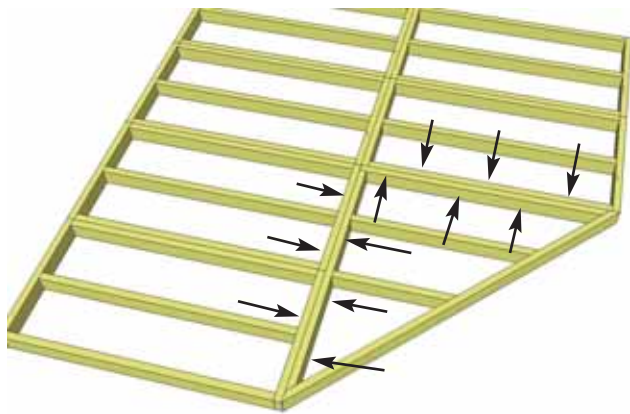

**7.** Place Triangular Floor Section tight against both Rectangular Floor Sections and secure with 6 - 2 1/2" screws per side. When Floor Frame Sections are all attached, your perimeter will be 111" x 111" x 55 1/2" x 55 1/2" x 78 1/2".

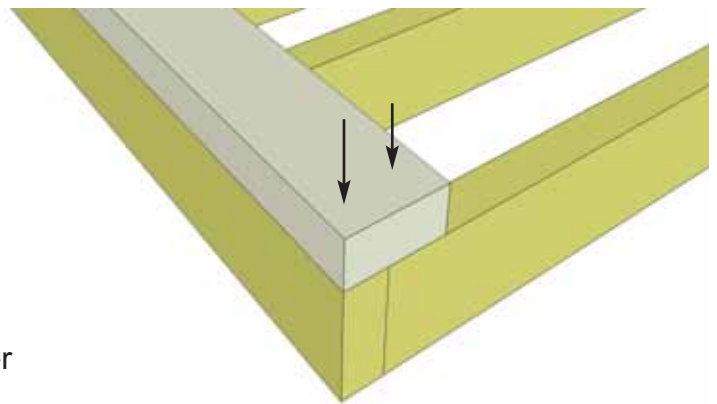
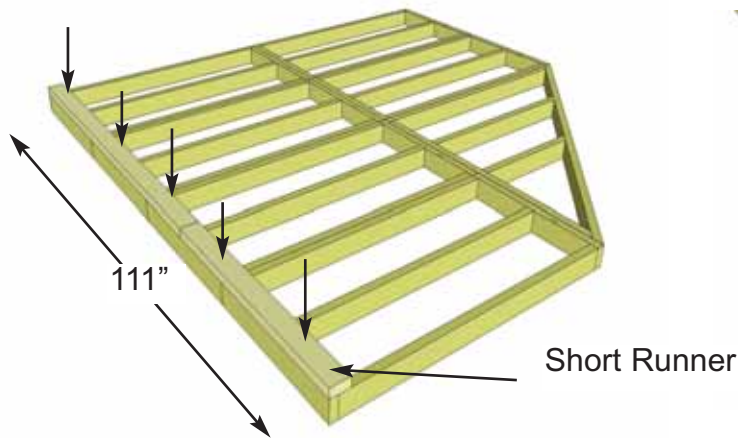

**8.** Attach **Floor Runners** to completed floor frame perpendicular to the floor joists. There are 8 floor runners in total. Starting on the 111" side, locate 2 Runners (69 1/2" & 41 1/2" long pieces). Use 6 - 2 1/2" screws per Runner to secure making sure that the Runner is flush to the outside but not overhanging.

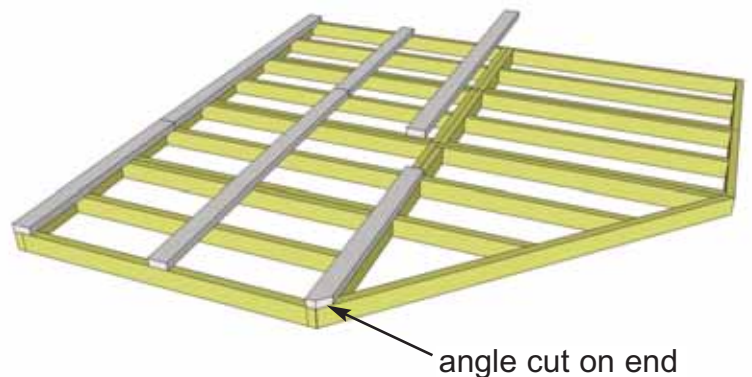

**9.** Locate the next 2 Runners (69 1/2" & 41 1/2" long). Alternate Runners so the longer piece is in the front. Position on center 27 3/4" from outside edge and attach as per **Step 8**. Place 3rd set of Runners on center Joists. Short Runner is angle cut on front end. Attach as per **Step 8**.

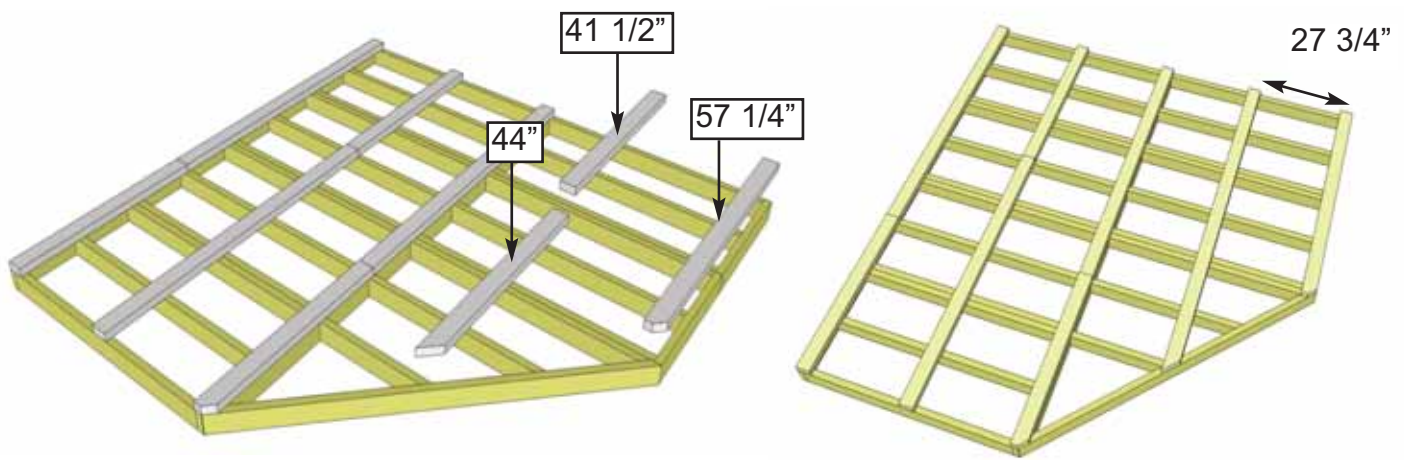

**10.** Attach remaining 3 Floor Runners (41 1/2" with straight cut ends and 44" angle cut 1 end) and 57 1/4" with angle cut end as per **Step 8 and 9**. The smaller runners will form a 85 1/2" runner when connected.

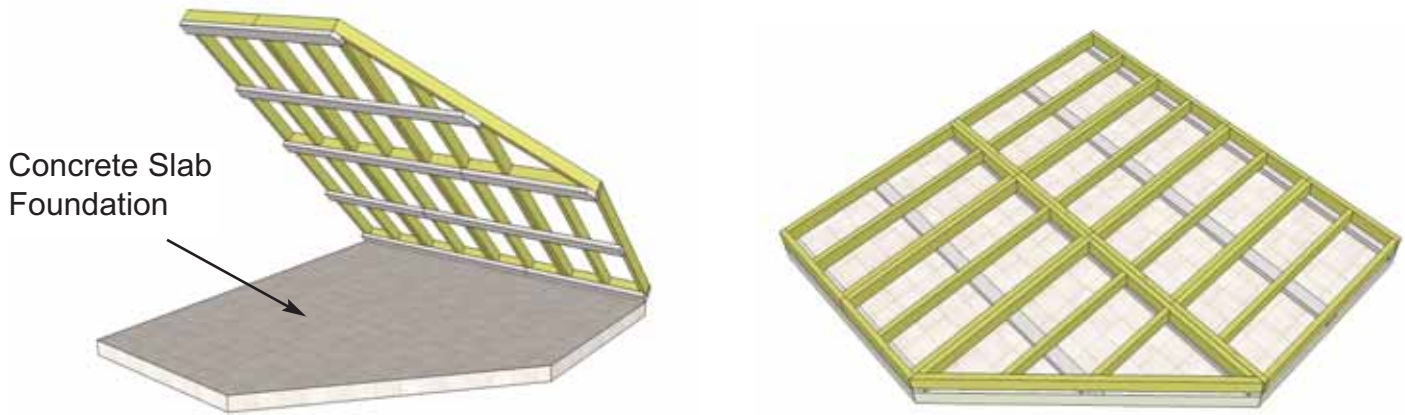

**11.** With Floor Runners attached, carefully flip the floor over and place on your foundation. **Caution:** you will need 2 people to assist you. Be careful when laying floor down not to bend or twist floor. When in place, level floor completely. **Note:** It is important to note that having a level foundation is critical. Choosing a foundation will vary between regions. Typical foundations can be concrete pads or patio stones positioned underneath the floor runners.

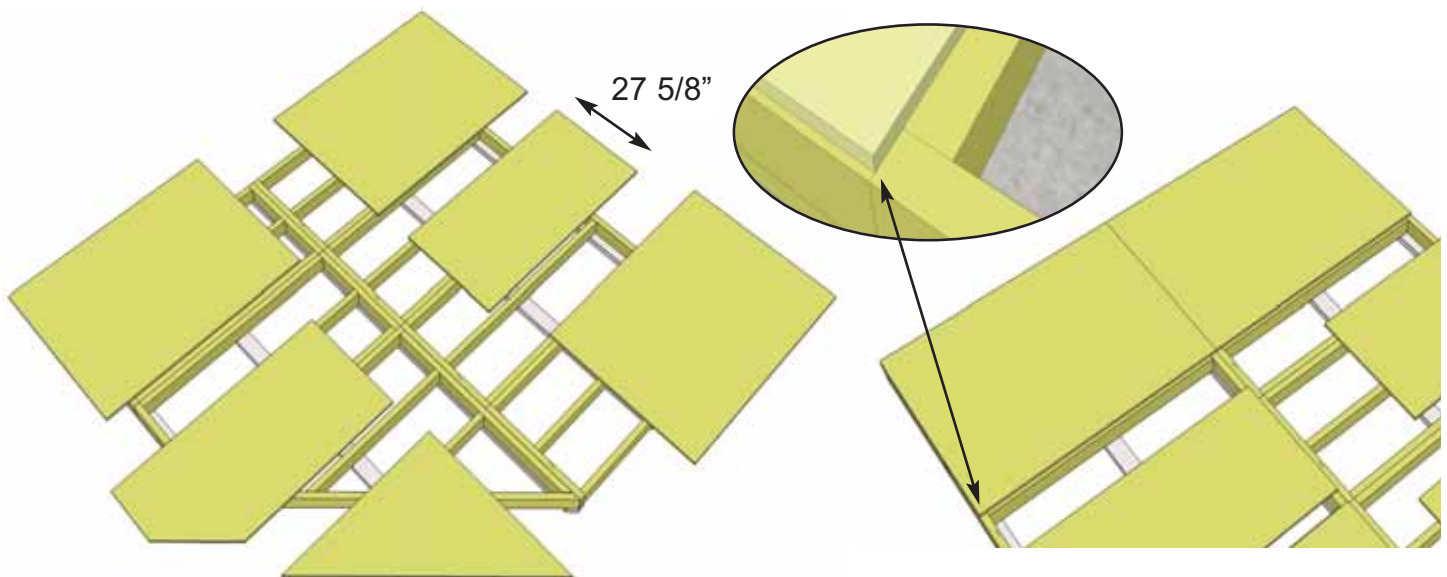

**12.** Position **Plywood Floor** pieces (6) on top of completed floor joists. Push Plywood Floor pieces together at seams. Plywood will sit slightly recessed from edge of Floor Frame.

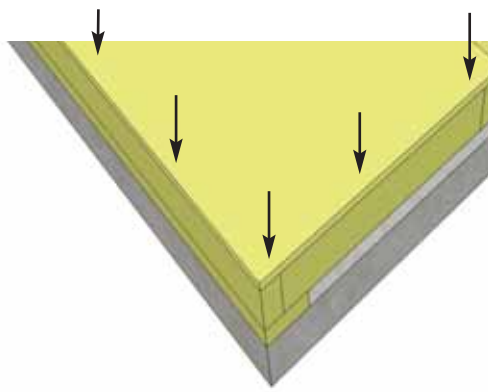

plywood pushed together at seam.

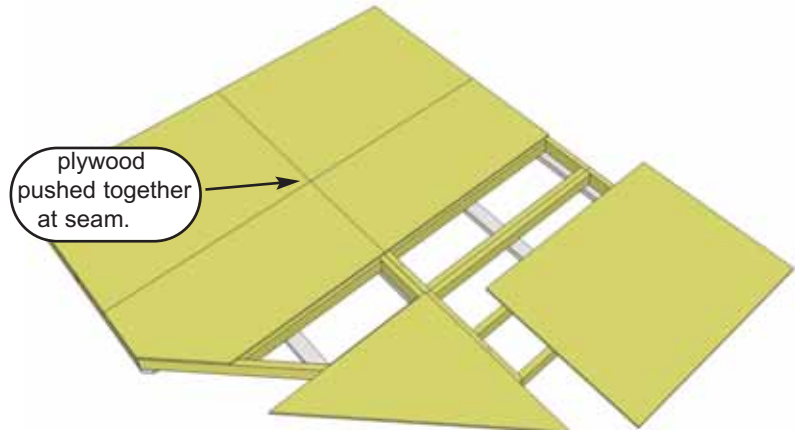

**13.** With Plywood positioned correctly on floor framing, attach with 1 1/4" screws. Use screws every 16". Position middle Plywood Floor pieces (27 5/8" wide) and secure as illustrated above.

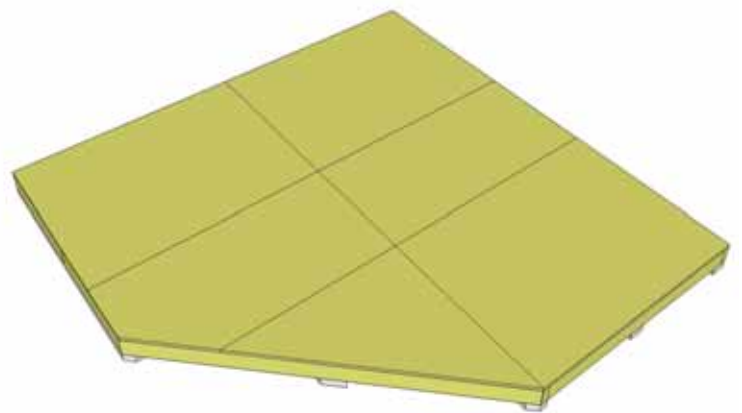
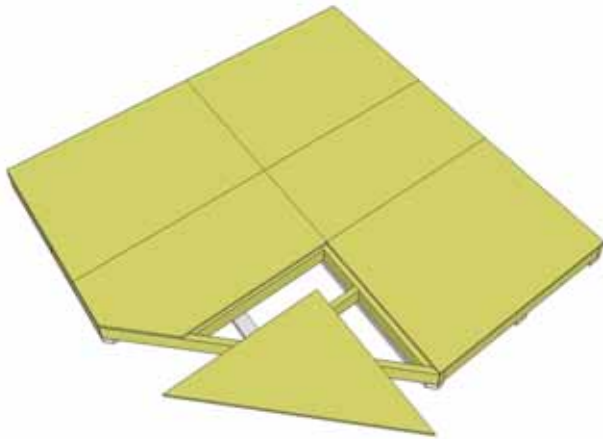

**14.** Complete remaining Plywood Floor pieces positioning and attaching as per **Step 12 & 13.**

## B. Wall Section

Exploded view of all parts necessary to complete the Wall Section. Identify all parts prior to starting.

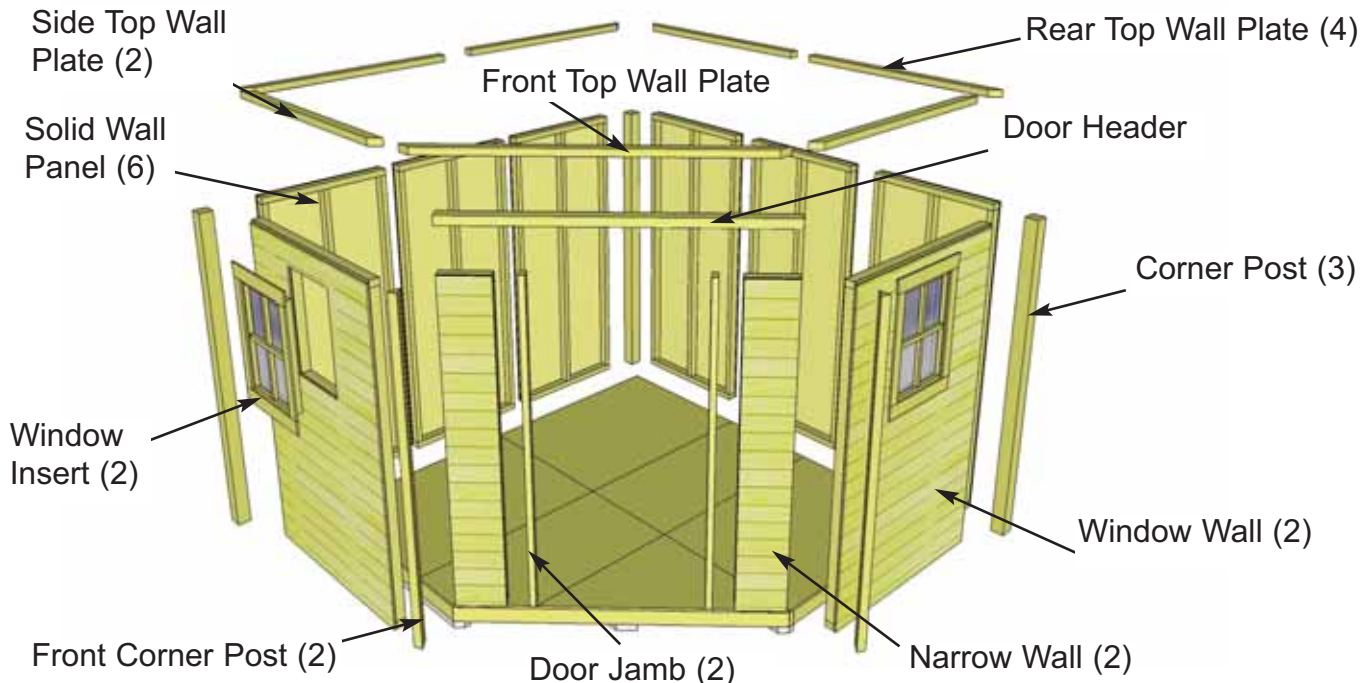



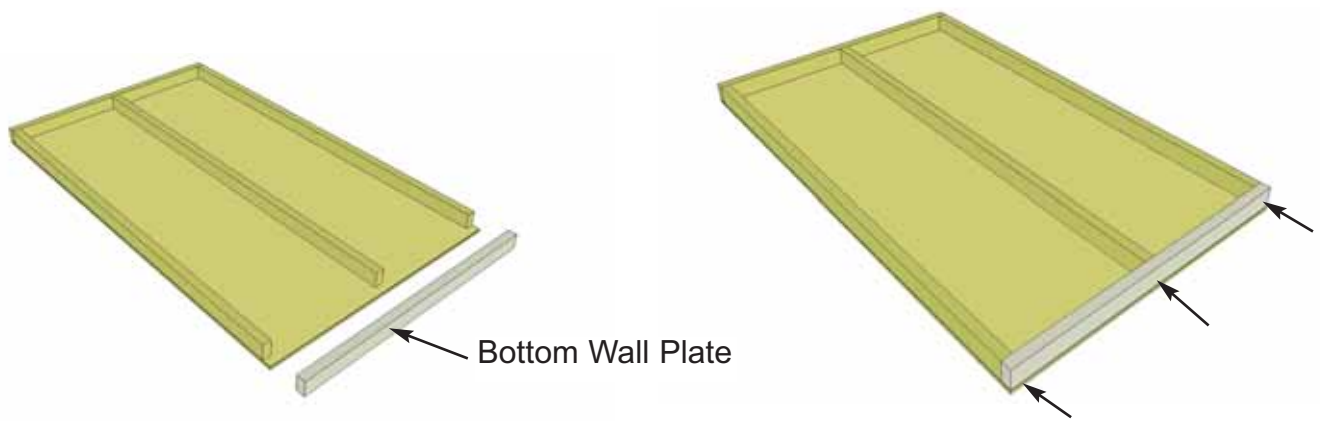

**15.** Starting with **Solid Wall Panels**, carefully lay panel face down. Position and attach **Wall Plate** to bottom of wall studs of each wall panel with 3 - 2 1/2" screws. Position so plates are flush with framing.

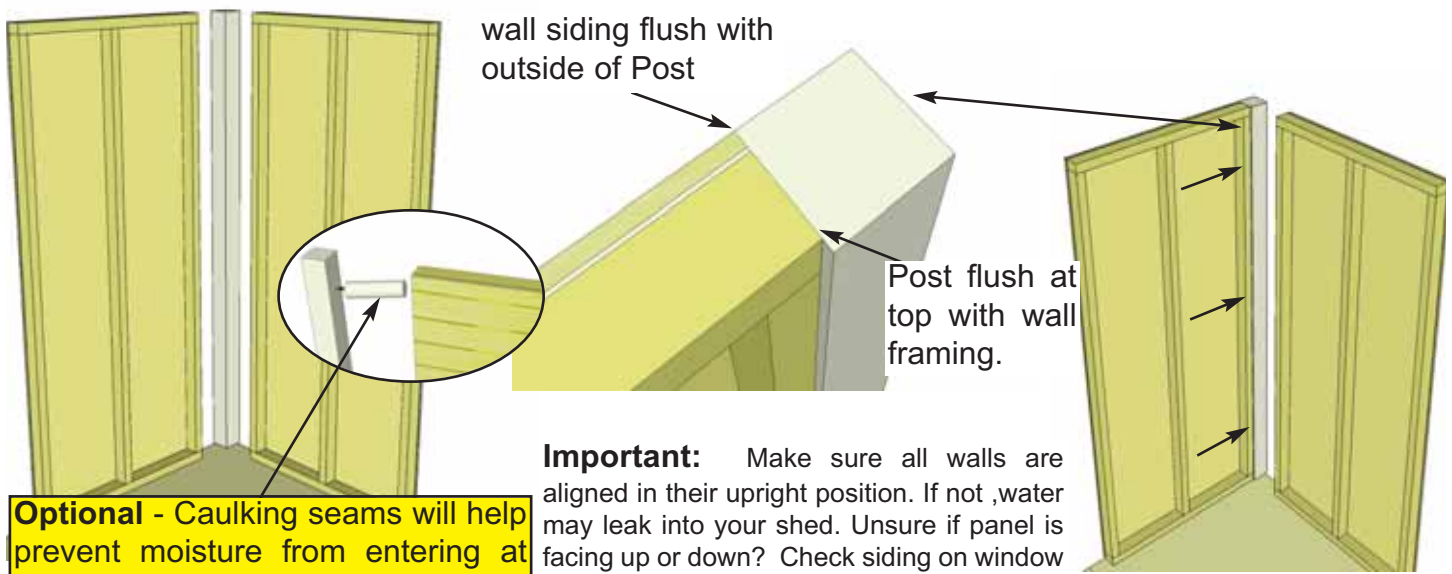

**Important:** Make sure all walls are aligned in their upright position. If not, water may leak into your shed. Unsure if panel is facing up or down? Check siding on window wall panel to match alignment.

**Optional - Caulking seams will help prevent moisture from entering at seam. Caulking not included in kit.**

**16.** Place 1 - 3 1/2" x 3 1/2" x 75" long Corner Post in the rear corner and 2 Solid Wall Panels on either side of Post. Align wall so outside of wall siding is flush with outside of the Post. Attach together with 3 - 2 1/2" screws. Screw at the bottom, middle and top of stud into Post to secure properly.

**Do Not Attach Walls To Floor Until Step 35.**

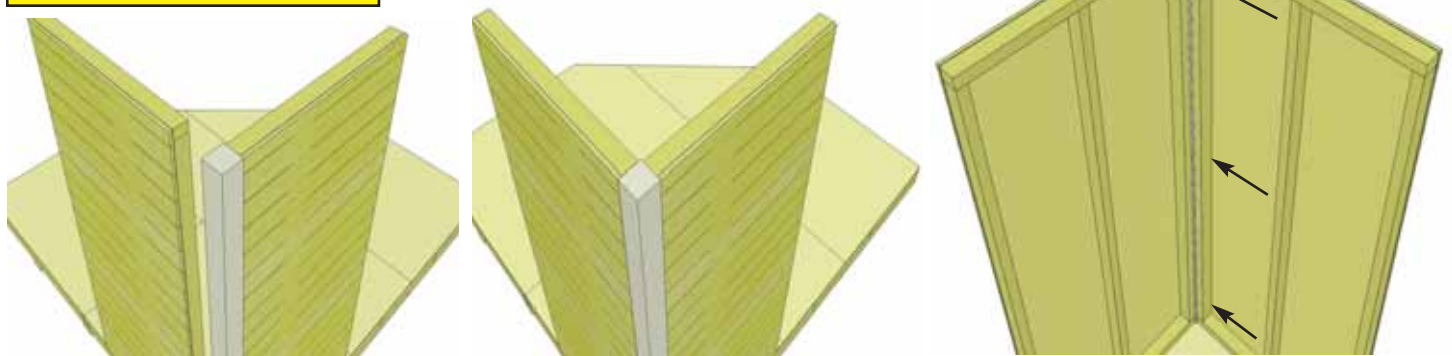

**17.** Position second Solid Wall corner panel to Post and secure as per **Step 16**. **Important: Do Not Attach Walls To Floor at this stage.**

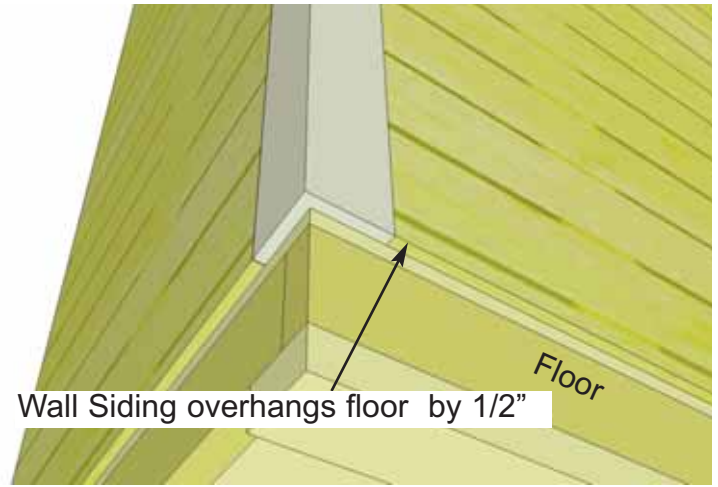
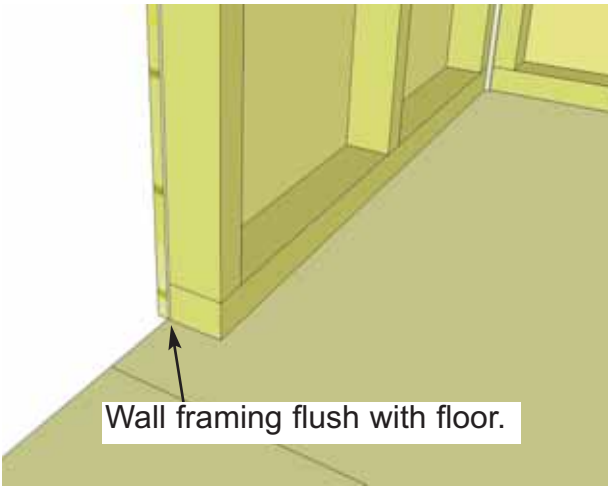

**18.** The Wall Panel framing will sit flush at the end of the plywood floor while the wall siding and Corner Post will overhang the floor by approximately 1/2".

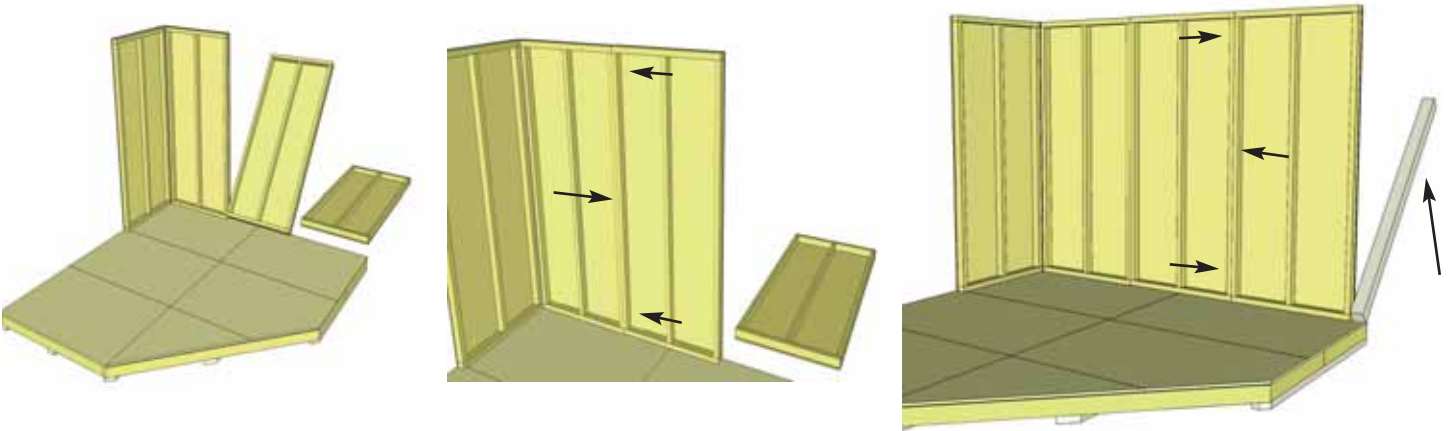

**19.** Position rear wall panels in place. Butt both vertical wall studs of rear walls together and attach with 3 - 2.5" screws. Screw at the bottom, middle and top of stud to secure properly. Complete both rear walls. Lift and position a Corner Post to end of outside rear wall panel.

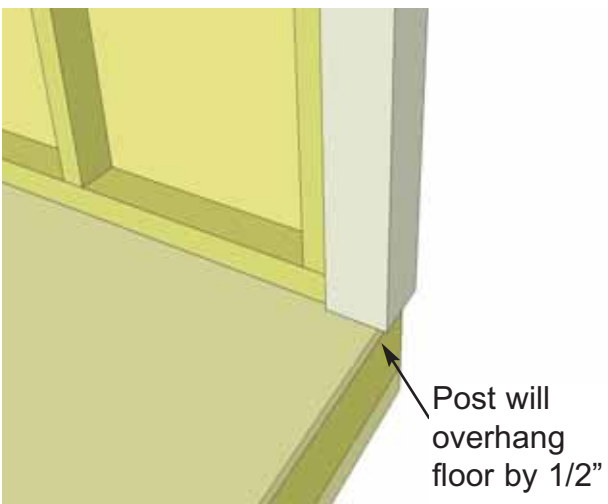

**20.** Position and secure Corner Post to rear wall stud as per **Step 16.**

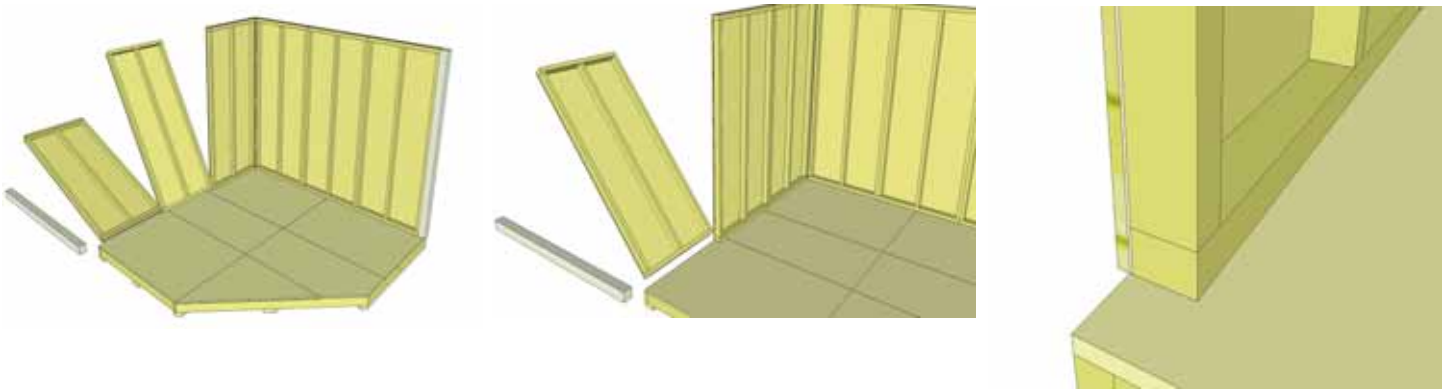

**21.** Position and attach adjacent rear Solid Walls as per **Steps 19-20.**

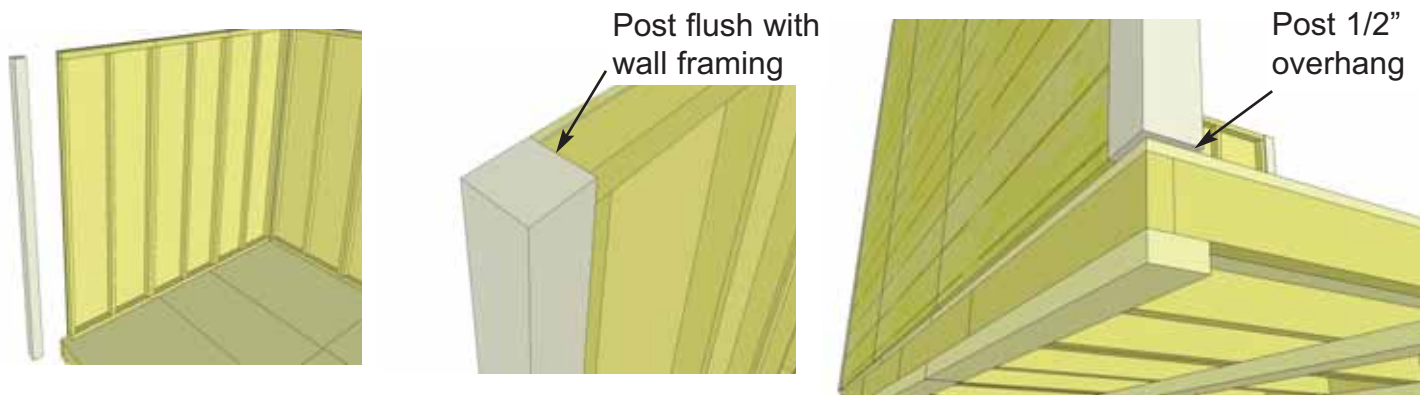

**22.** Position and secure Corner Post to rear wall stud as per **Step 16.**

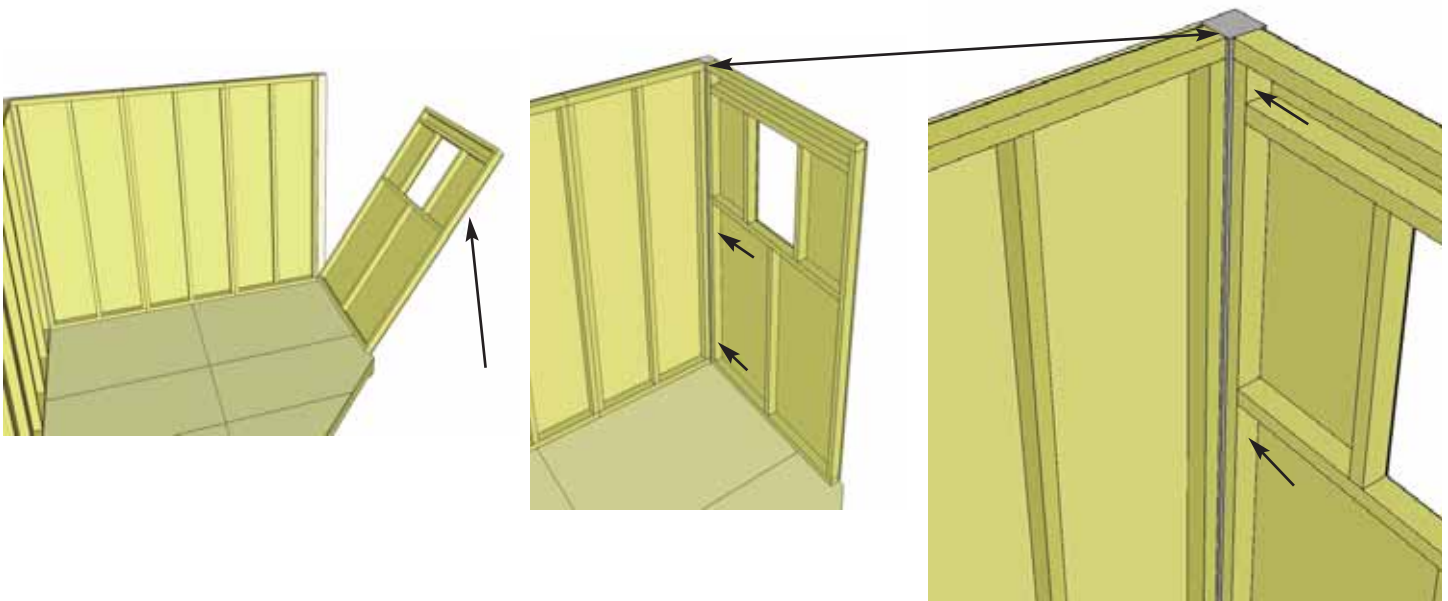

**23.** Locate a Window Wall Panel. Position and attach wall stud to Corner Post as per **Step 16.**



**24.** Position Window Wall Panel on floor as per **Step 18.**

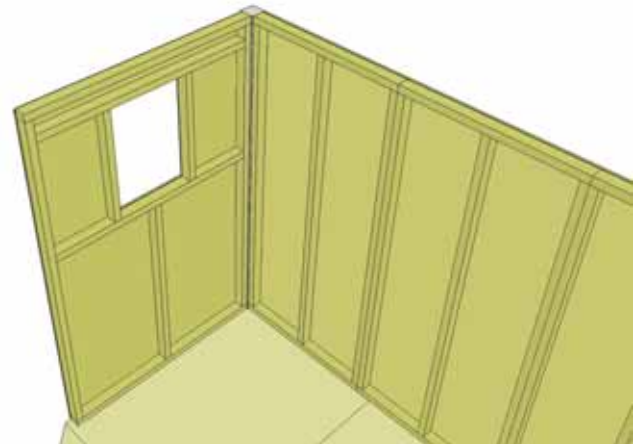
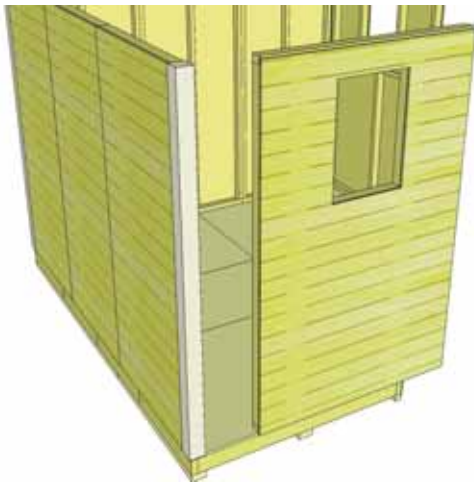

**25.** Position and attach remaining Window Wall Panel as per **Steps 23 - 24.**

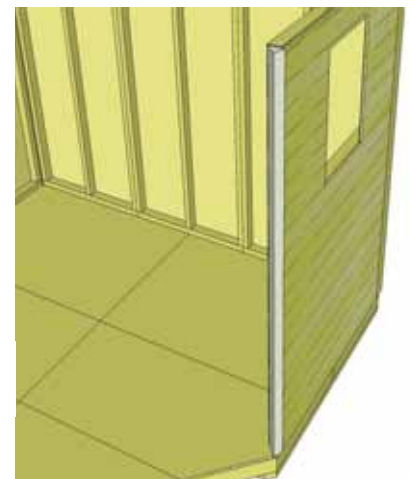
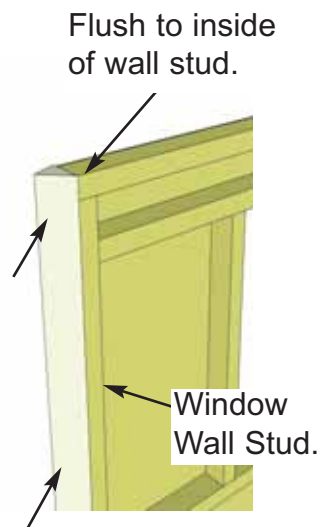
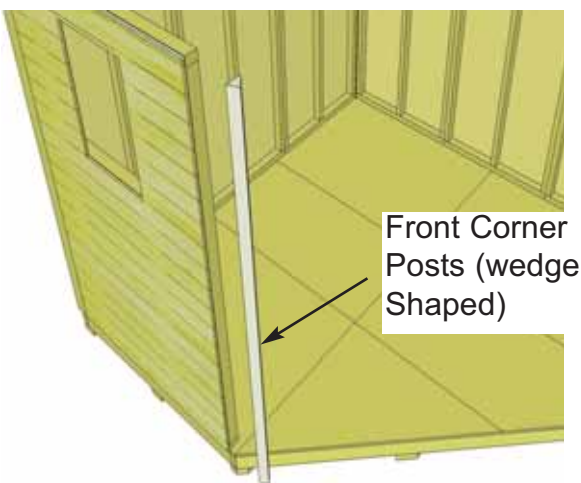

**26.** Place a Front Corner Post against an outside Window Wall Stud with the tip of the wedge flush to the inside. Attach with 3 - 2 1/2" screws at top, middle and bottom locations. Complete both sides.

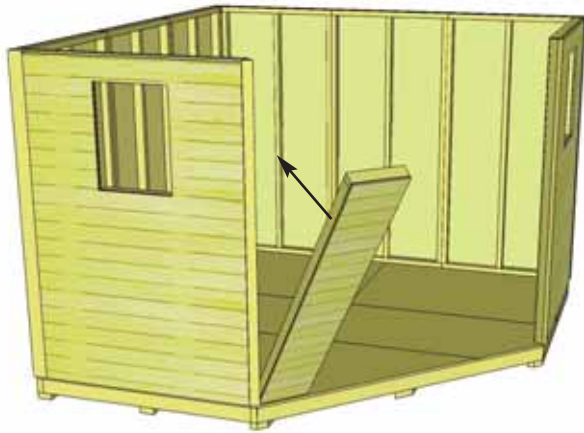

**27.** Position a Narrow Wall Panel to left side of shed against Front Corner Post. Position wall framing on Post as per **Step 26**. **Note:** Narrow Walls are 73" high (2" shorter than the regular walls).

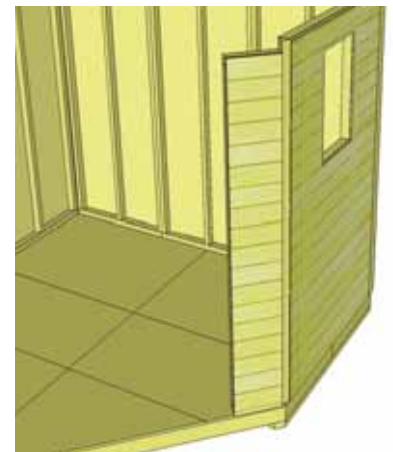
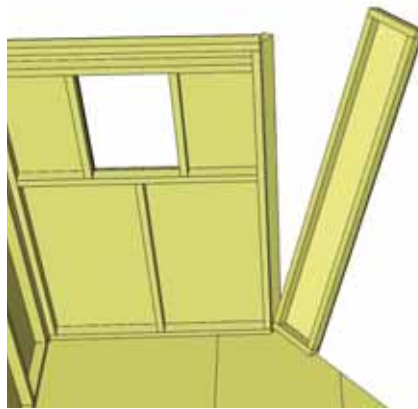
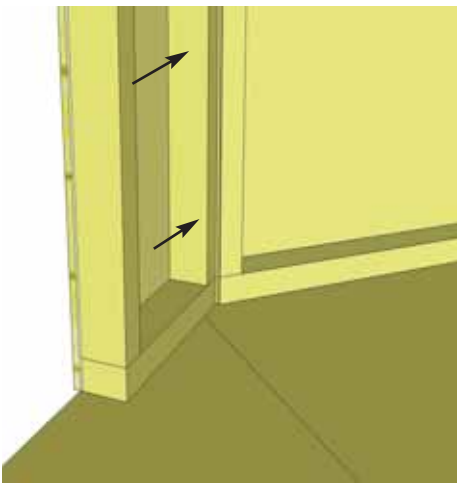

**28.** With Narrow Wall properly positioned, secure from wall stud, through wedge into Window Wall stud with 3 - 2 1/2" screws.

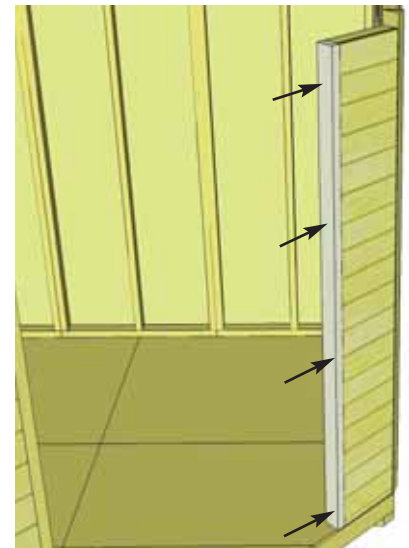
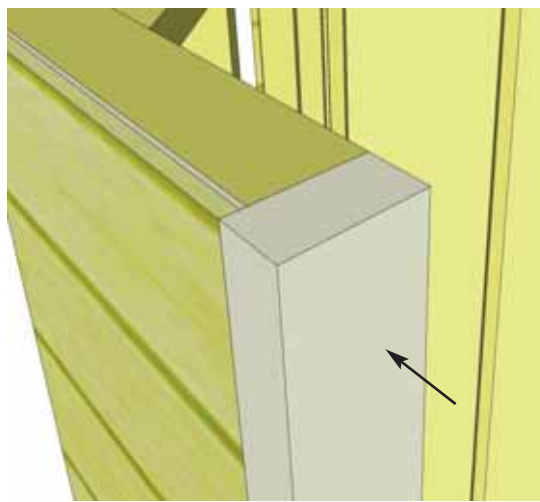
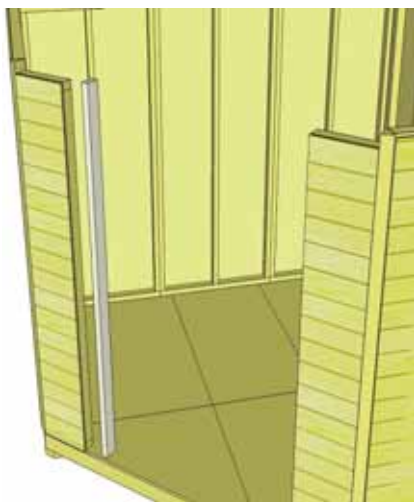

**29.** Locate Vertical Door Jambs and position flush against left Narrow Wall Panel stud. The Jamb is 3 1/8" wide and will sit flush to outside of wall siding. When positioned correctly, secure both Jambs using 4 - 2.5" screws.

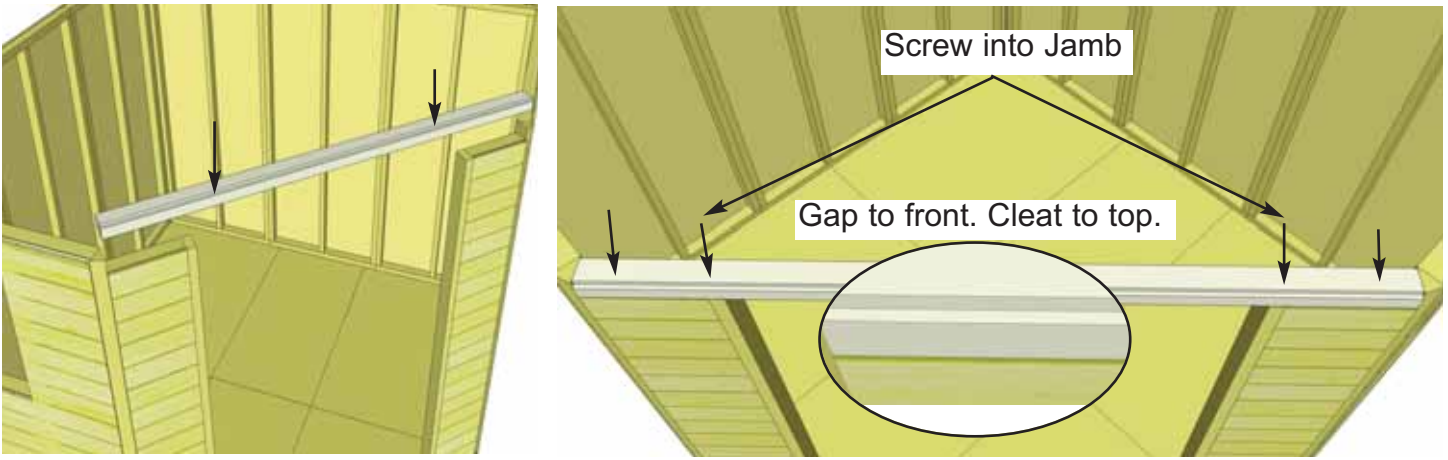

**30.** Position and attach the Door Header to Door Jamb and Narrow Wall Panel top framing. Header should sit flush with Door Jamb and Outside of Narrow Wall Panel Siding. Attach with 4 - 2.5" screws. **Important:** Before attaching door header, make sure opening is exactly **49 3/4"** across the top of doorway, and the same when screwing walls to floor (49 3/4" across the bottom (**Step 39**)). This will ensure an accurate opening for door installation. Use Threshold Doorstop as spacer template to also confirm doorway opening.

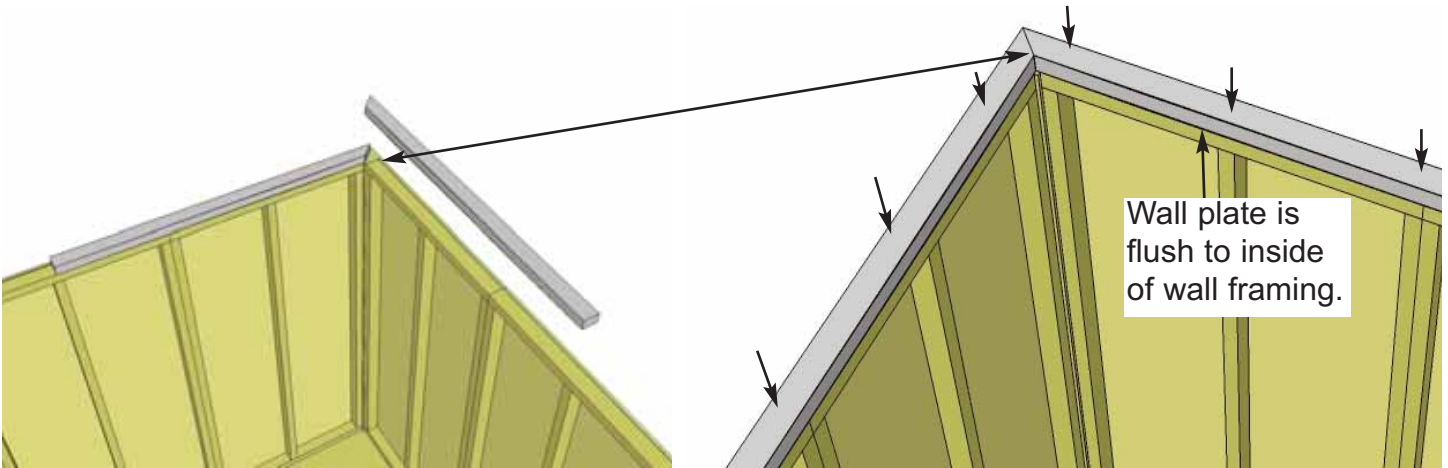

**31.** Locate 2x3 Rear Wall Plates (55 1/2" long with 45 degree cut at 1 end). Position in rear corner and secure each plate with 4 - 2 1/2 screws.

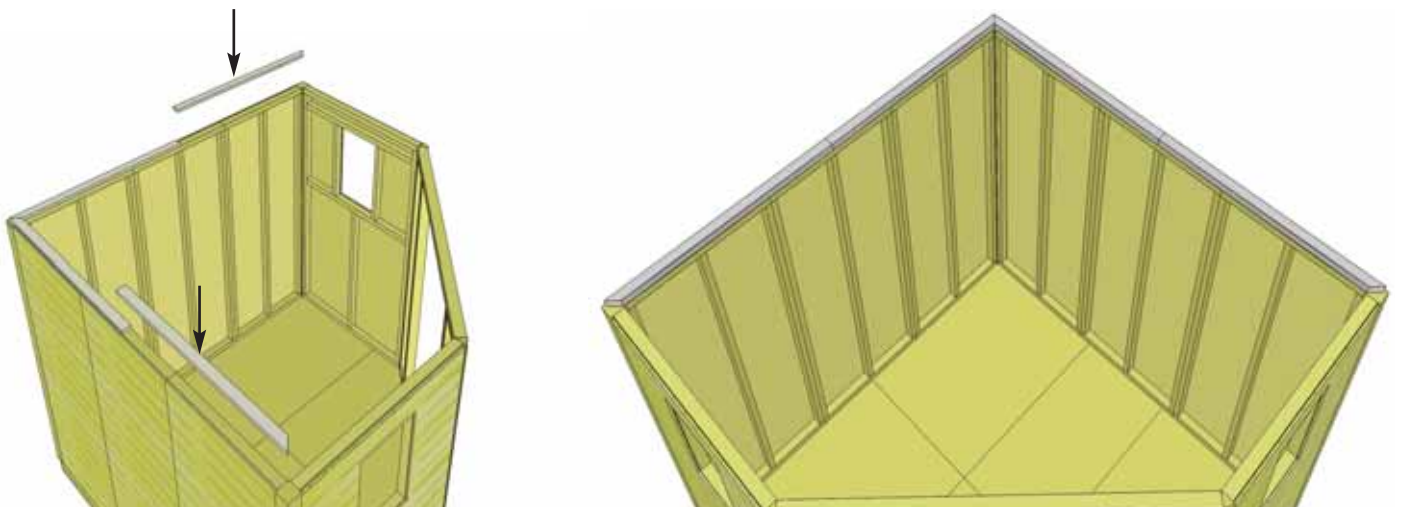

**32.** Position and attach remaining Rear Wall Plates as per **Step 31**.

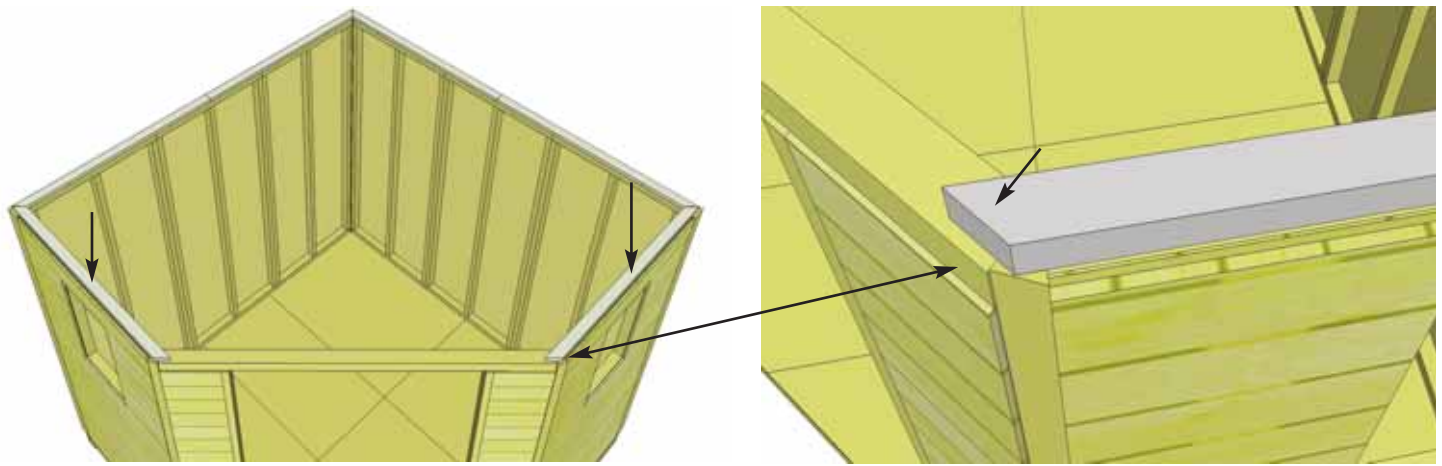

**33.** Locate and position both Sidewall Plates on top of walls. Sidewalls Plates are 55" long and are 45 degree angle cut on both ends. Attach with 4 - 2 1/2" screws per piece.

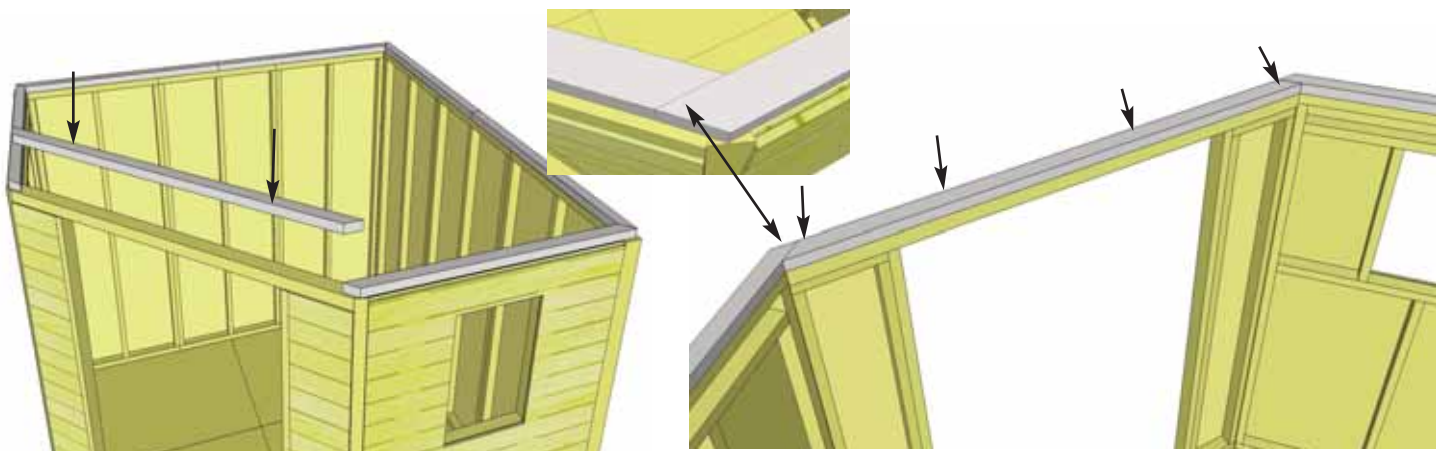

**34.** Locate Front Wall Plate (76 1/2" long and 45 degree angle cut on each end). Position and attach as other Wall Plates. Plate should be flush to inside wall framing.



Angle screws into perimeter Floor Joists.

**35.** When all walls are attached together, check alignment with the floor. Bottom wall framing should sit flush with outside of floor joists, with siding overhanging by 1/2". When positioned correctly, fasten bottom wall plates to floor using 4 - 2 1/2" screws per wall panel. If purchased without floor option, anchor walls to foundation to secure.

**Optional** - Caulking seams will help prevent moisture from entering at seam. Caulking not included in kit.

Doorway Opening 49 3/4"



# C. Rafter Section

View of all parts necessary to complete the Rafter Section. Identify all parts prior to starting.

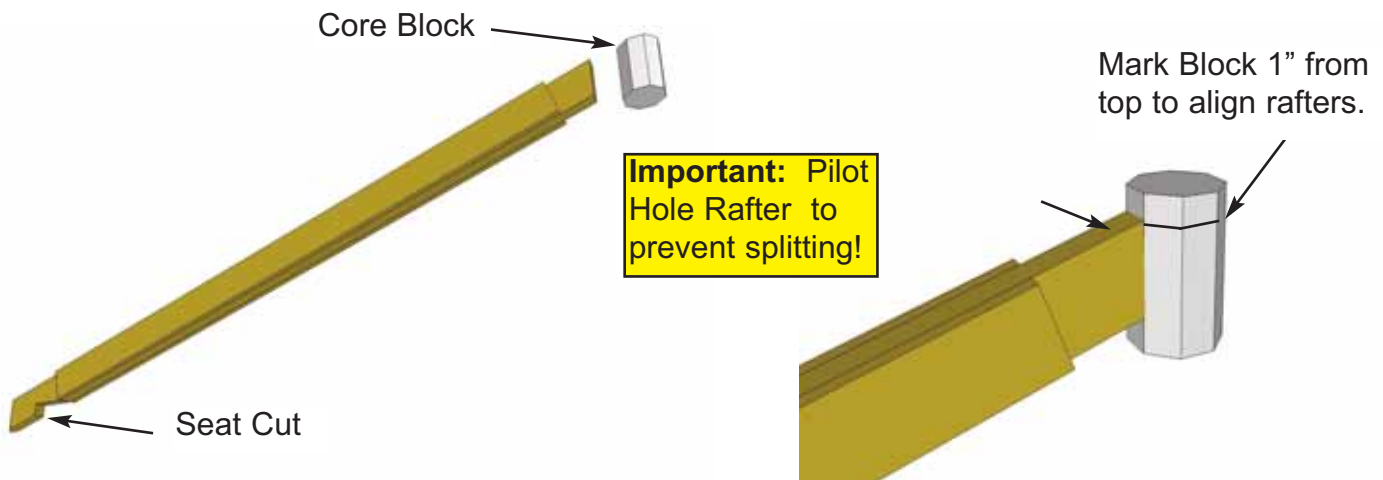
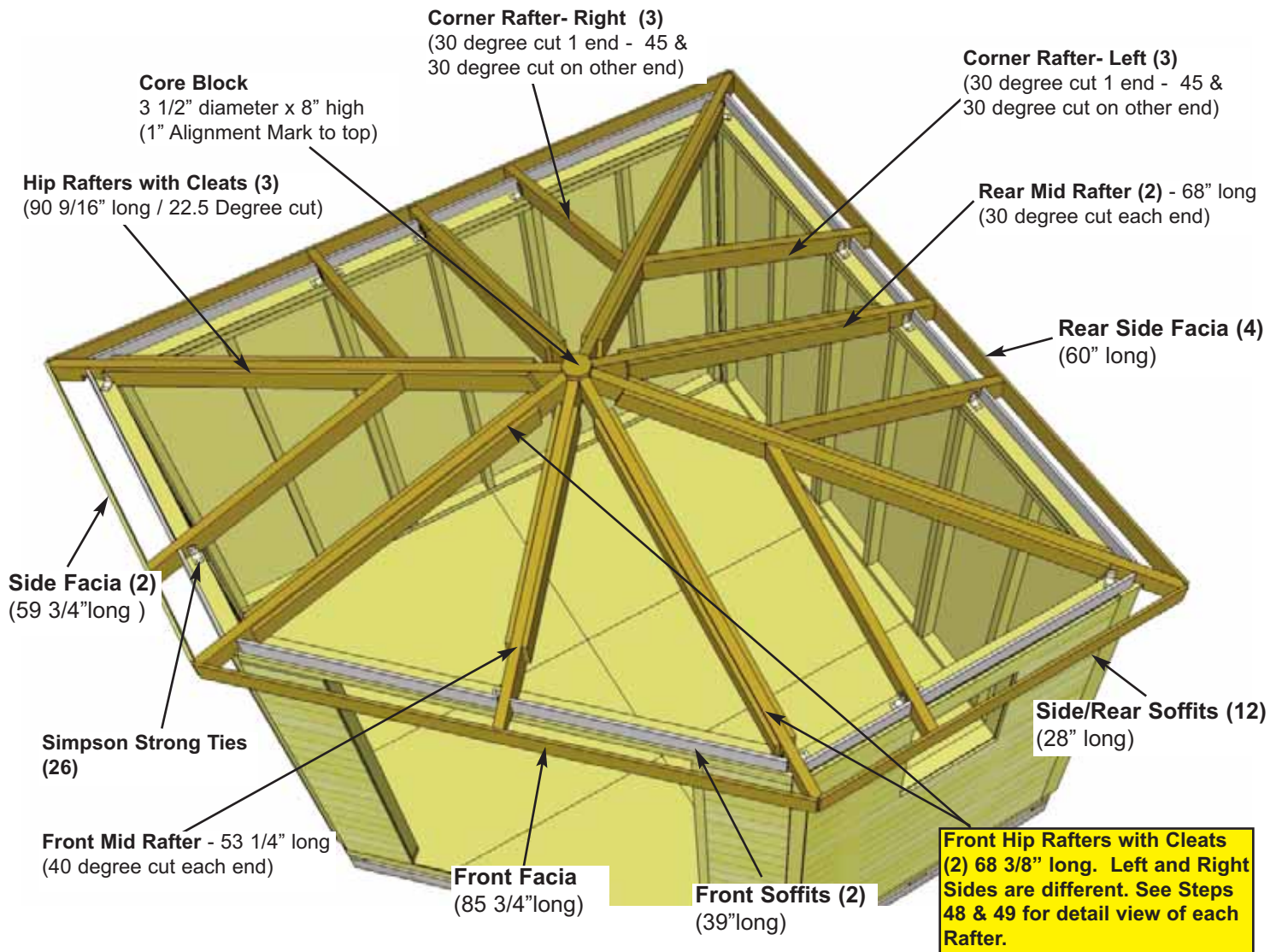

**36.** Locate Hip Rafters with Cleat (90 9/16" long) and Core Block. On the ground, angle screw end of Hip Rafter to Core Block with 1 - 3" long Screw. **Drill 1/8" diameter pilot hole in rafter to prevent splitting.**



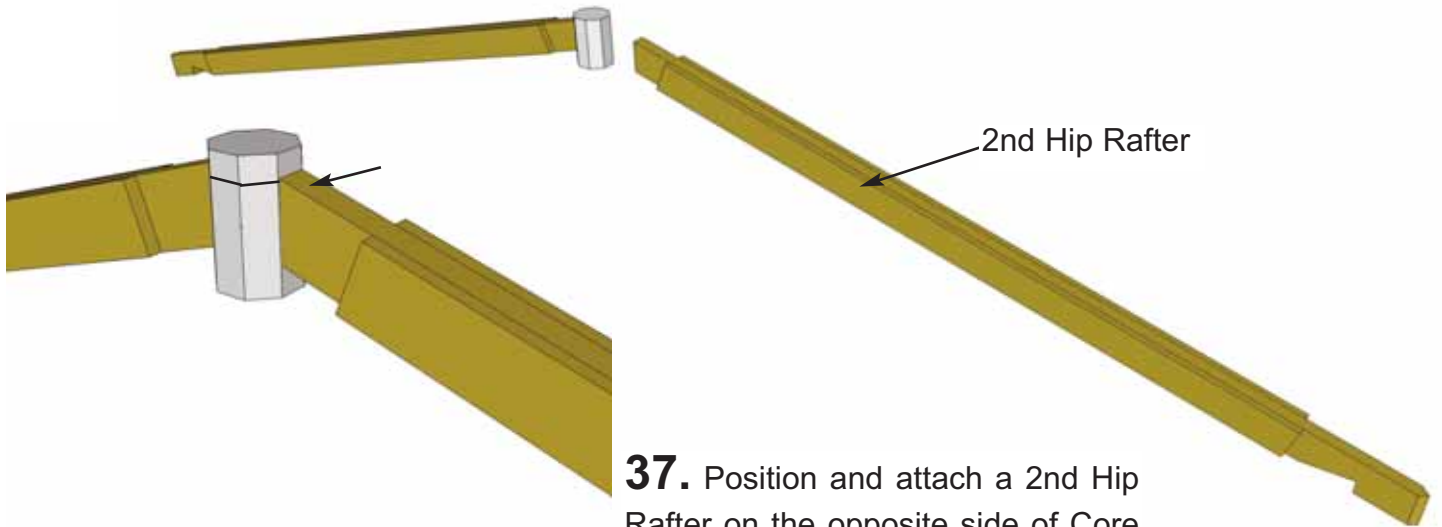

**37.** Position and attach a 2nd Hip Rafter on the opposite side of Core Block as per **Step 36**. Be sure to pilot hole Rafter to prevent splitting. Be careful to support both Rafters.



**38.** Attach the Final Hip Rafter at 90 degrees to other rafters as per **Step 36**. Once again, drill pilot hole to prevent splitting.

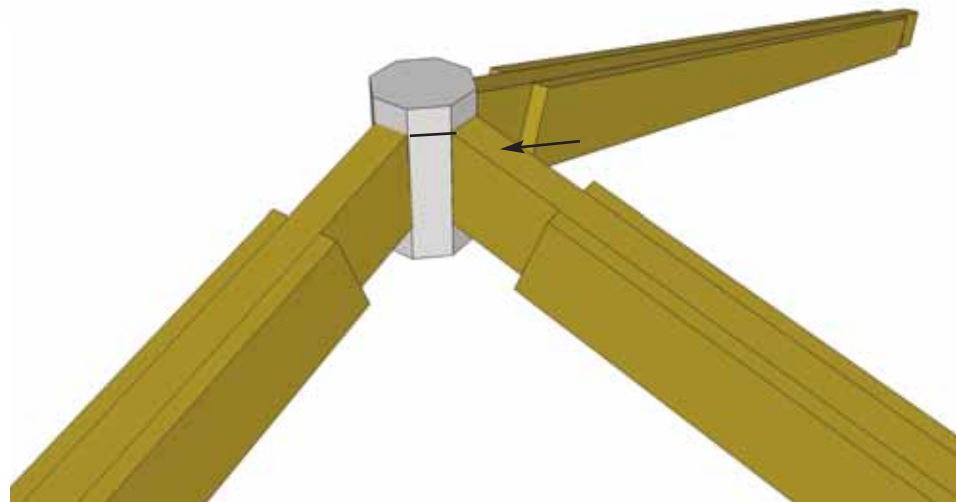

**39.** Locate Front Mid Rafter (53 1/4" long / 40 degree angle cut on ends). Position on Core Block 90 degrees from other rafters. Attach as per **Step 36**. Remember to drill pilot hole to prevent splitting and be careful to support all the attached rafters.

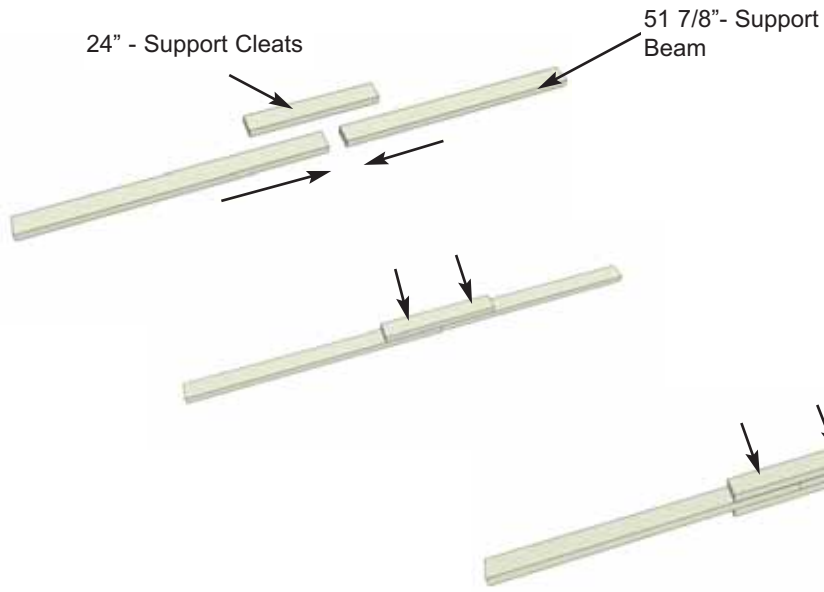
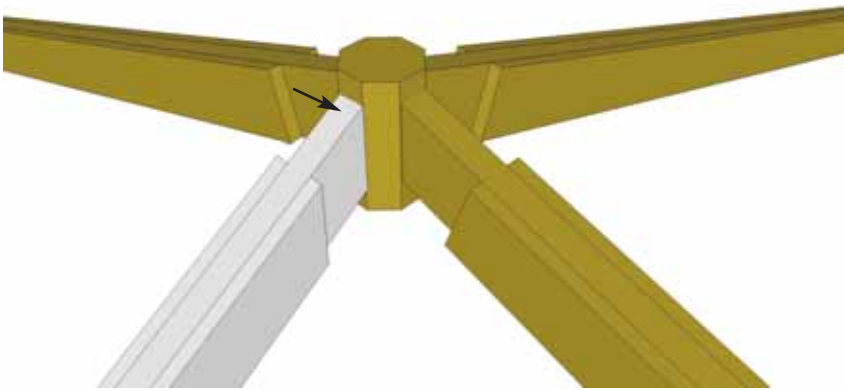
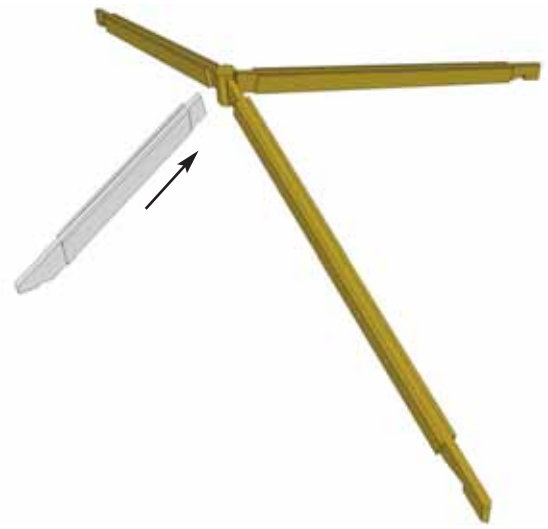

**40.** Prior to lifting up semi-completed Rafter Section on to walls, complete assembly of Temporary Support Beam for Rafters / Core Block. The Support Beam when completed will be 104 1/2" high.

**41.** Place both 51 7/8" pieces together and attach with a 24" long Support Cleat with 2 - 2 1/2" screws. Flip over and attach a 2nd Cleat. Screw Plywood Base - 5 1/2" x 5 1/2" to bottom of Support Beam with 2 - 1 1/2" screws.



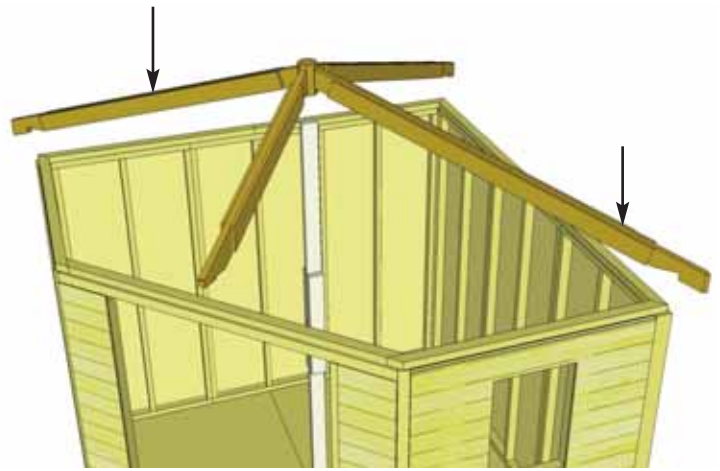
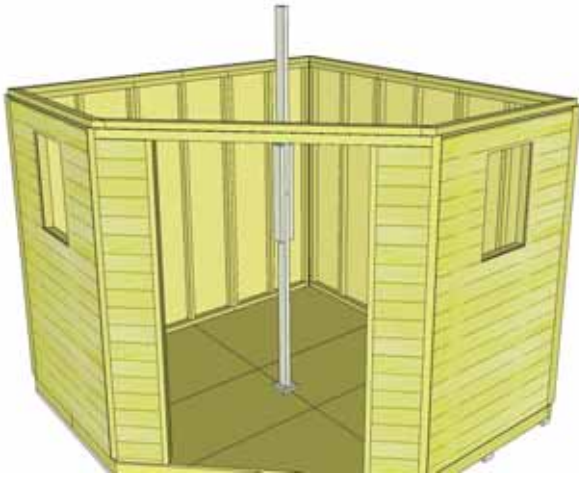

**42.** Place Temporary Support Beam inside the shed prior to lifting semi-completed Rafter Section on to walls. Using 3 people, lift the Rafter Section up, carefully supporting Hip Rafters.

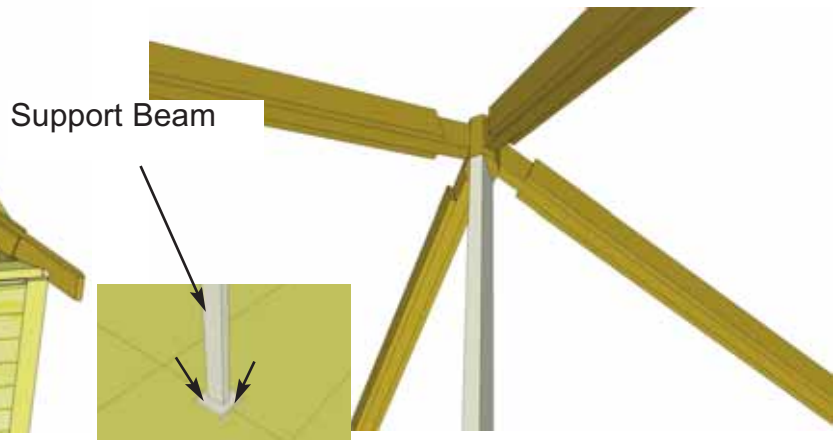
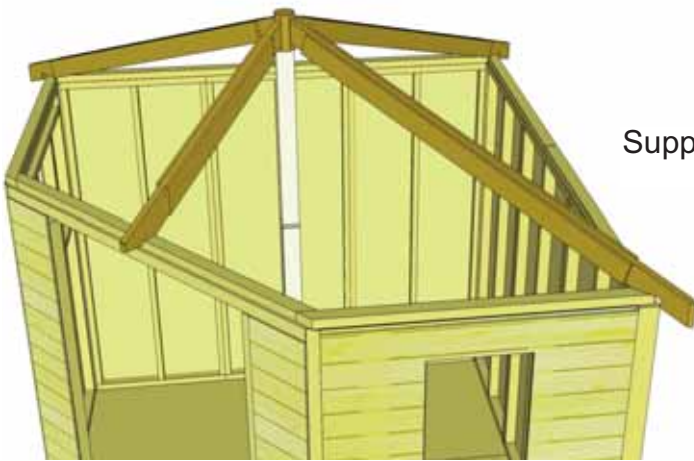

**43.** Place seat cut of Hip Rafter in each corner. Position Front Mid Rafter seat cut equally from side to side on front wall Top Plate. Position Temporary Support Beam directly below Core Block to support entire Rafter Section. Tack Support Beam Plywood Base to floor with 2- 1 1/4" screws.

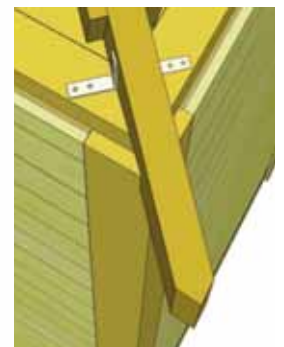
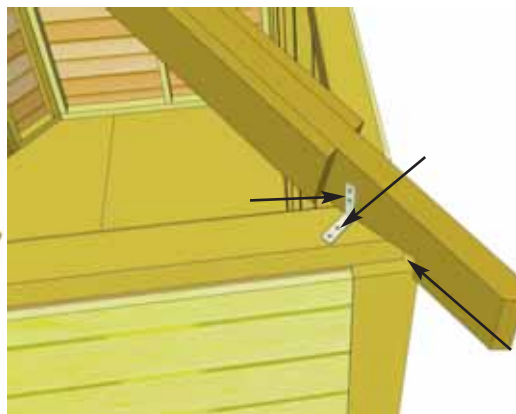
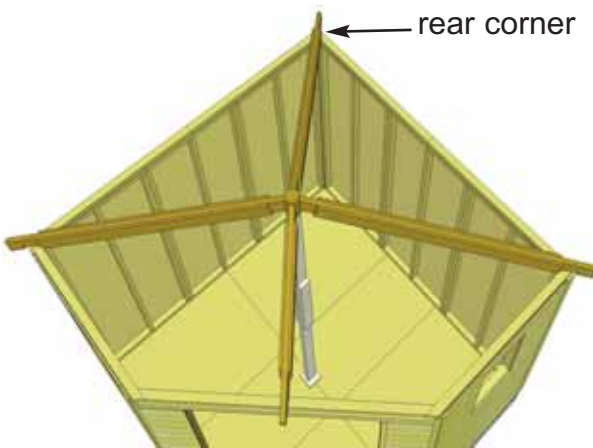

**44.** Starting at rear corner, center Hip Rafter equally on corner. Push rafter tight against corner of Top Plates. With a Simpson Strong Tie, tack rafter into position using 2 - 1 1/4" screws. (When main rafters are all aligned correctly, go back and completely secure rafter using 2 Simpson Strong Ties per Rafter and 4 - 1 1/4" screws.) Complete all Hip Rafters.

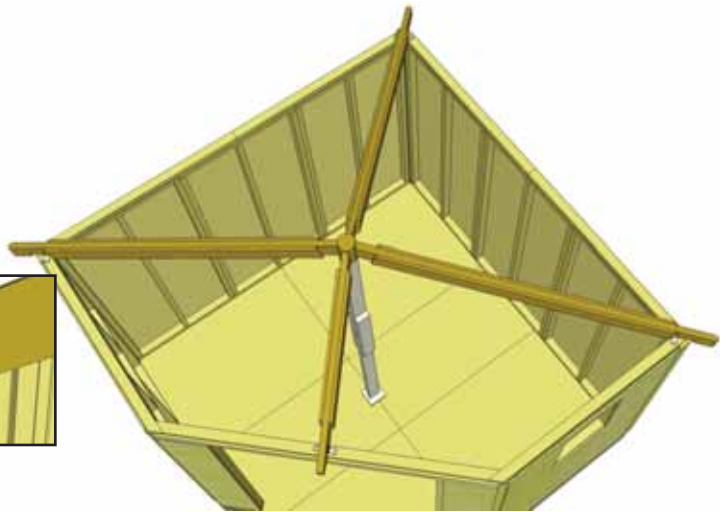
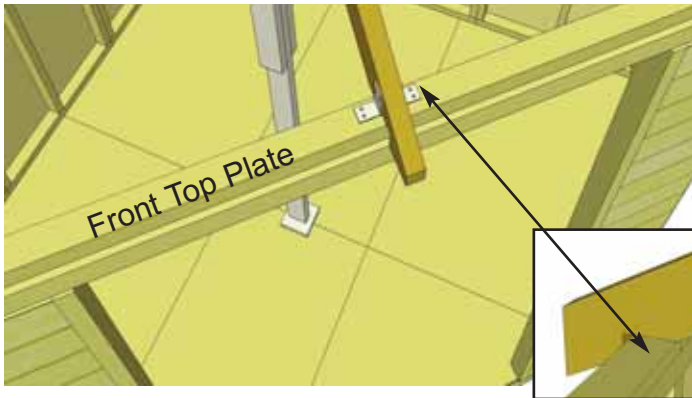

**45.** With Front Mid Rafter equally positioned from side to side on Front Top Plate and seat cut of rafter 1/8" past the outside of top plate, secure with 2 Simpson Strong Ties and 8 - 1 1/4" screws.

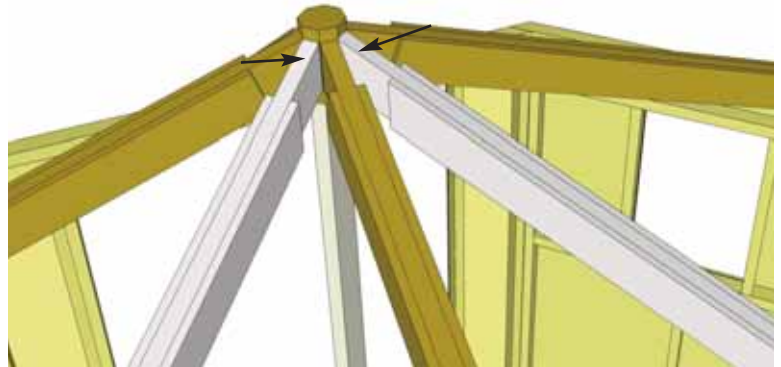
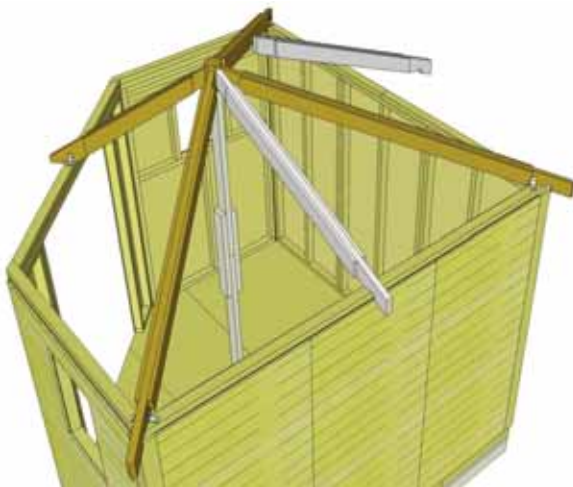

**46.** Using a Step Ladder, attach both Rear Mid Rafters (68" long) to 1" alignment mark on Core Block with 1 - 3" screw per Rafter. Once again, drill 1/8" diameter pilot hole in rafter end to prevent splitting of wood.

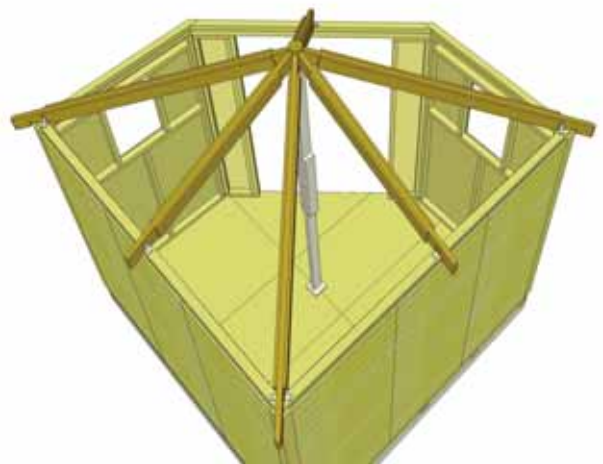
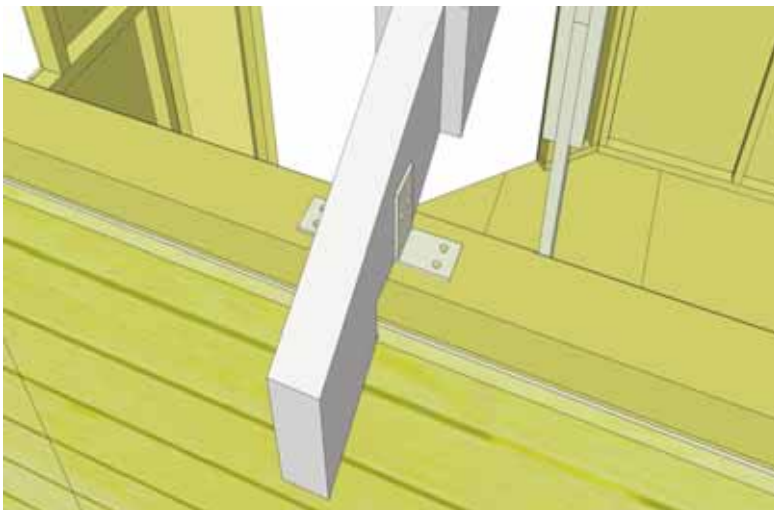

**47.** Equally space from side to side Mid Rafter on Rear Top Plates on walls. Align rafter so seat cut is 1/8" past the outside of the Top Plate. When positioned correctly, secure with 2 Simpson Strong Ties and 8 - 1 1/4" screws.

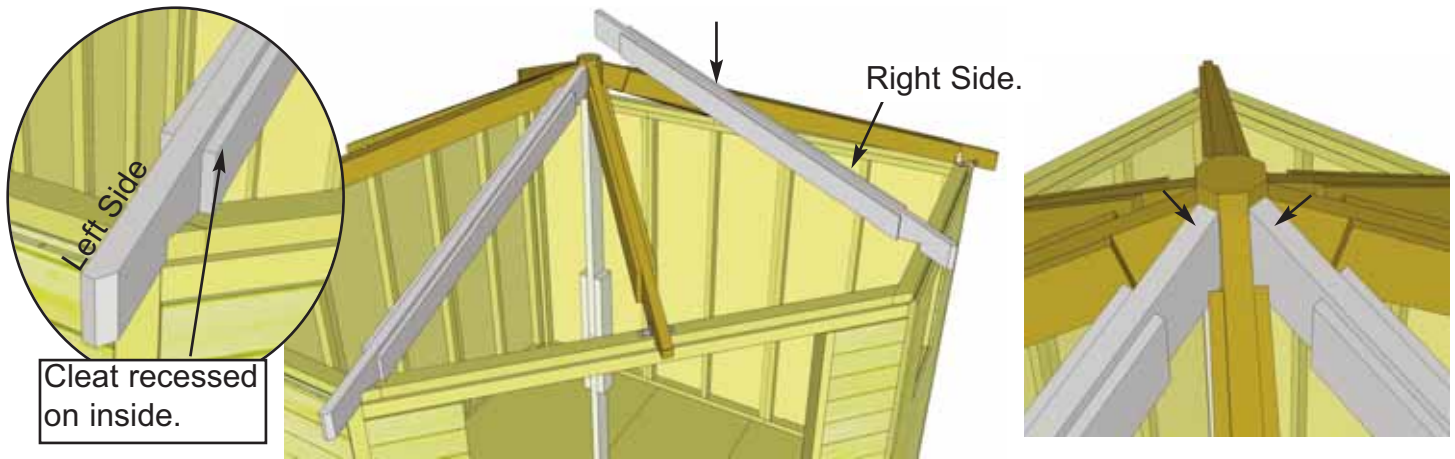

**48.** Locate and attach both Left and Right Front Hip Rafters with Cleats (68 3/8" - 30 & 45 Degree cuts at one end). Align Left and Right Rafters so cleats are recessed on inside. Attach to Core Block Alignment line as per **Step 46**.

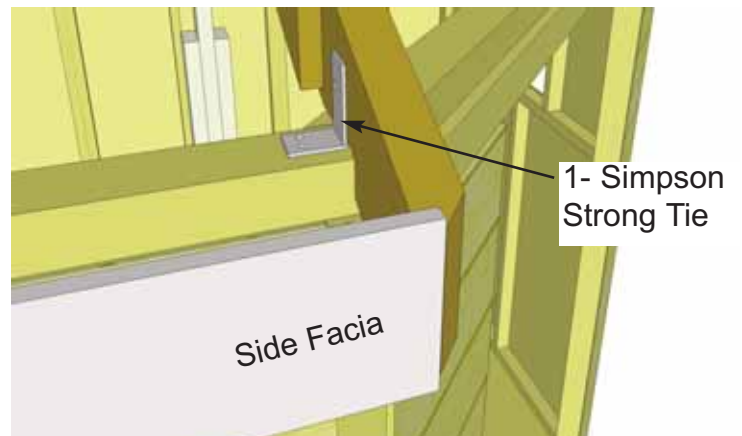

**49.** To correctly align Front Hip Rafters, use Side (59 3/4" long) and Front Fascia (85 3/4" long) boards as a template. Starting with 1 Front Hip Rafter, place Side Fascia against end of corner Hip Rafter end. (align on 45 degree angle). Move Front Hip Rafter so end of Side Fascia lines up. Tack Front Hip Rafter down with 1 Simpson Strong Tie and 2 - 1 1/4" screws. (may have to re-position later).

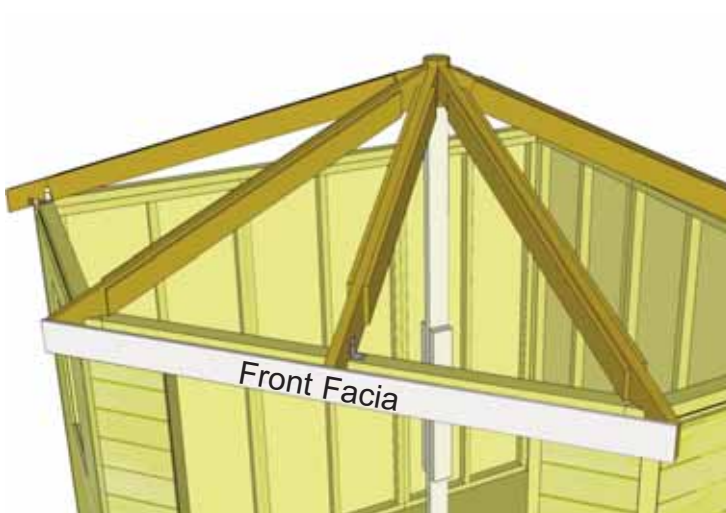

**50.** Use Front and Side Fascia to assist in positioning 2nd Front Hip Rafter. If rafter is out of alignment, reposition 1st Front Hip Rafter until both rafters are reasonably aligned. When satisfied with position of both rafters, secure each with 1 - Simpson Strong Tie and 4 - 1 1/4" screws.

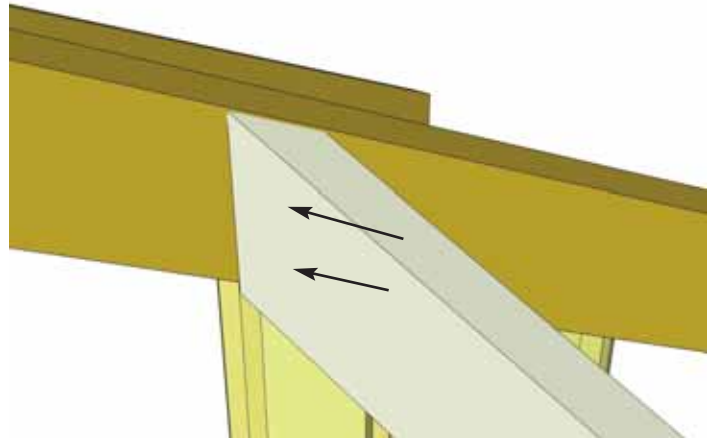
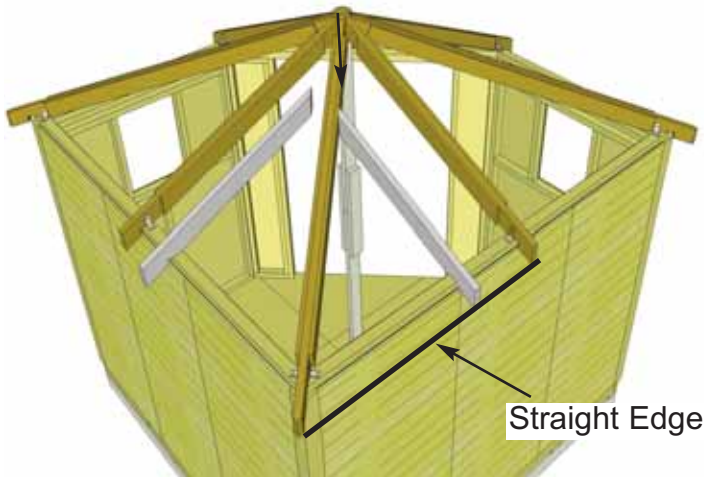

**51.** Locate Left and Right Corner Rafters. Position a set on a corner Hip Rafter. Align as per **Step 47**. Use a Straight Edge to line rafter end with corner Hip and Mid Rafter ends. Attach to Hip Rafter with 2 - 3" screws.

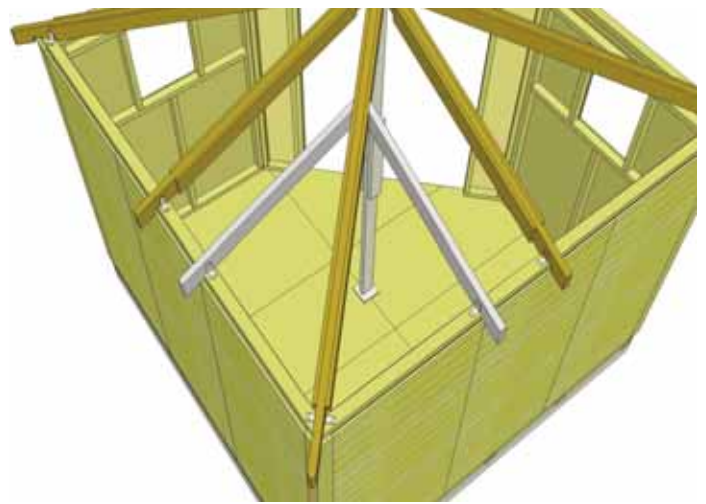
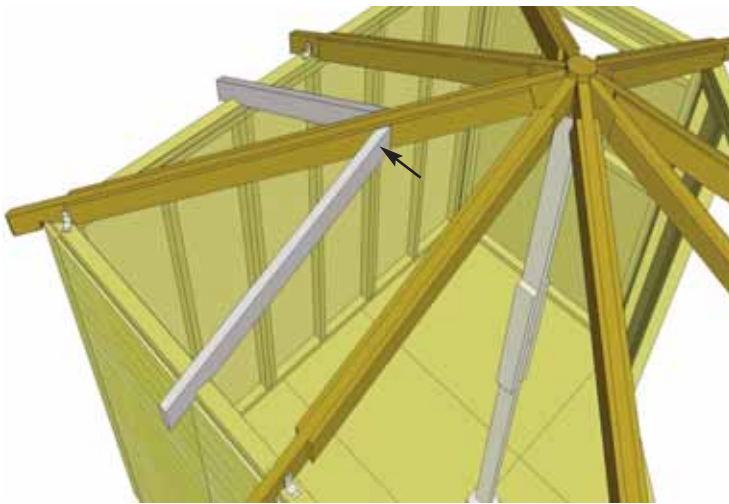

**52.** Complete both Left and Right Corner Rafters, aligning and attaching as per **Step 51**. Secure with 2 Simpson Strong Ties and 8 - 1 1/4" screws per rafter.

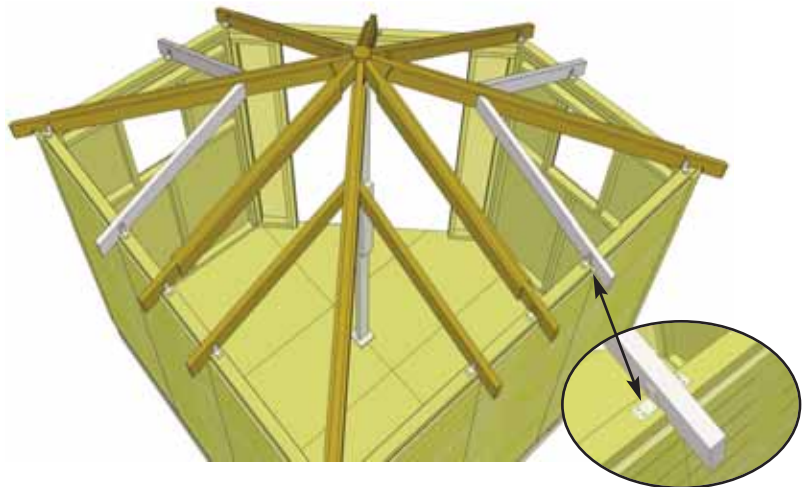
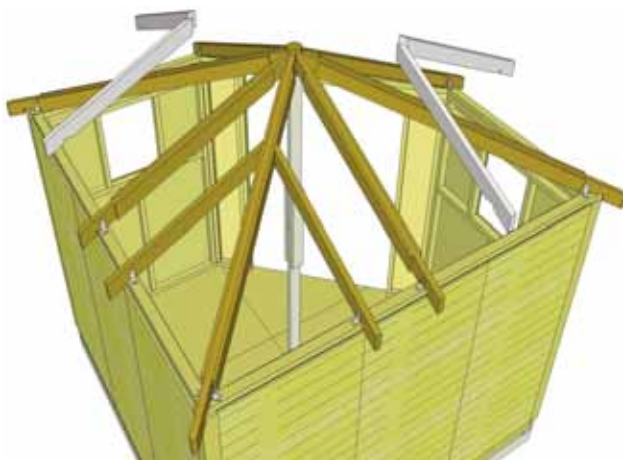

**53.** Complete remaining Corner Rafter sets, aligning and attaching as per **Steps 51-52**.

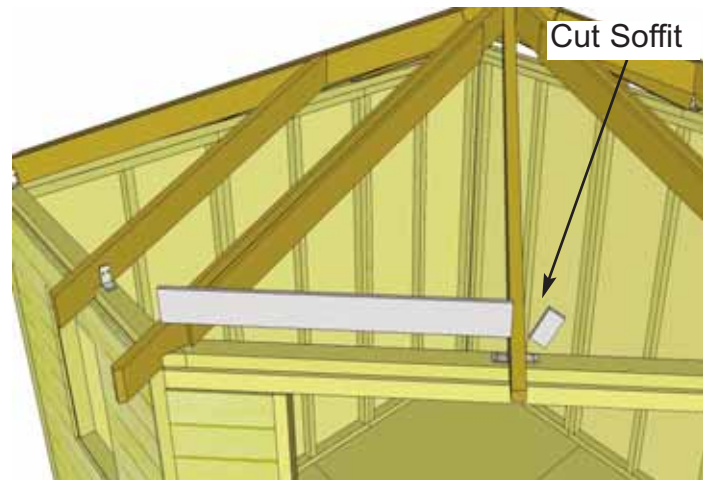

**54.** Installing Soffits prior to completing Facia and Roof Panels makes for an easier installation. Rafter location may vary slightly so Soffits will have to be measured and cut to size. Locate Front Wall Soffits (2 - 1/2" x 4 1/2" x 39"). Place between Front Hip and Front Mid Rafters, measure, mark and cut Soffit so when sitting flush against Top Wall Plate, it will be tight against both rafters.

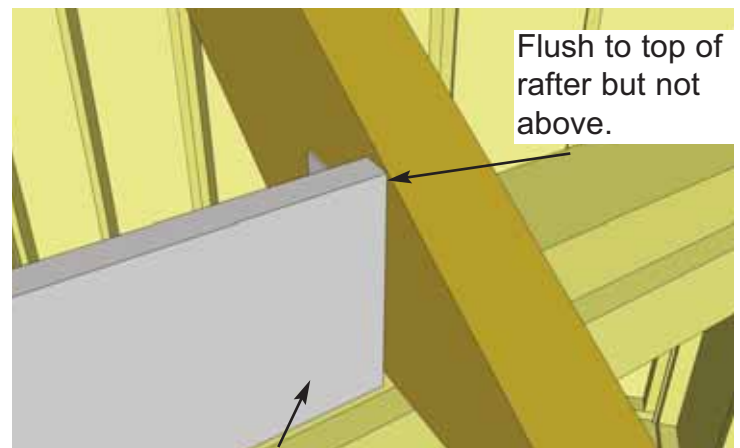
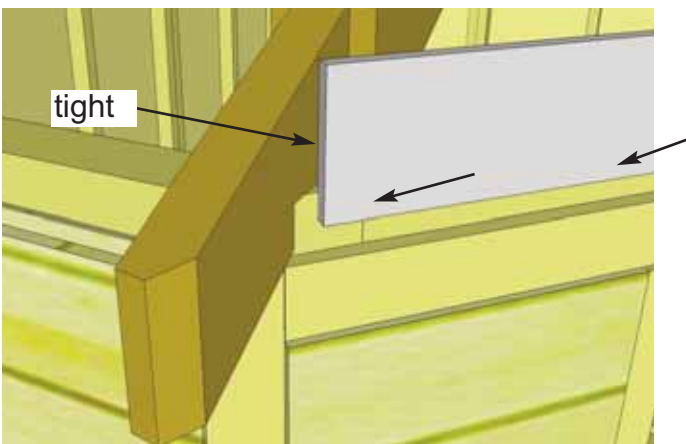

**55.** Align Soffit tight to rafter. **Important:** Soffit should not ride above Rafter or will impede with correct roof panel alignment later. When aligned properly, attach Front Wall Soffit to Top Wall Plate with 4 - 1 1/4" screws.

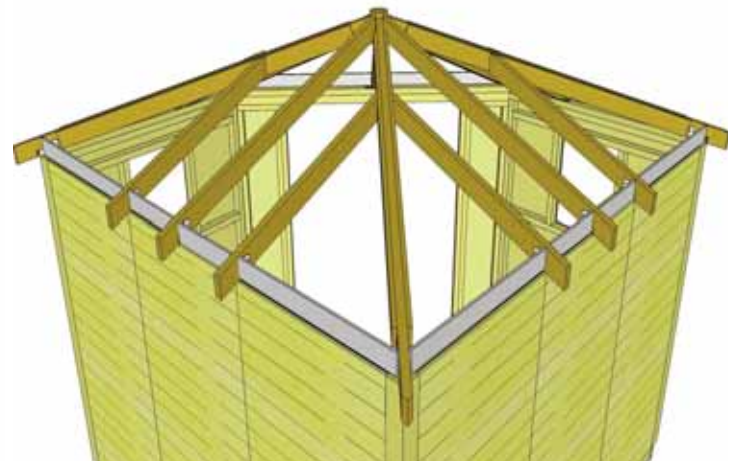

**56.** Complete attachment of remaining Front Wall Soffit. Locate 12 Side and Rear Soffits (28" Long). Follow **Step 54** to measure and cut to fit, to complete Soffit Section.

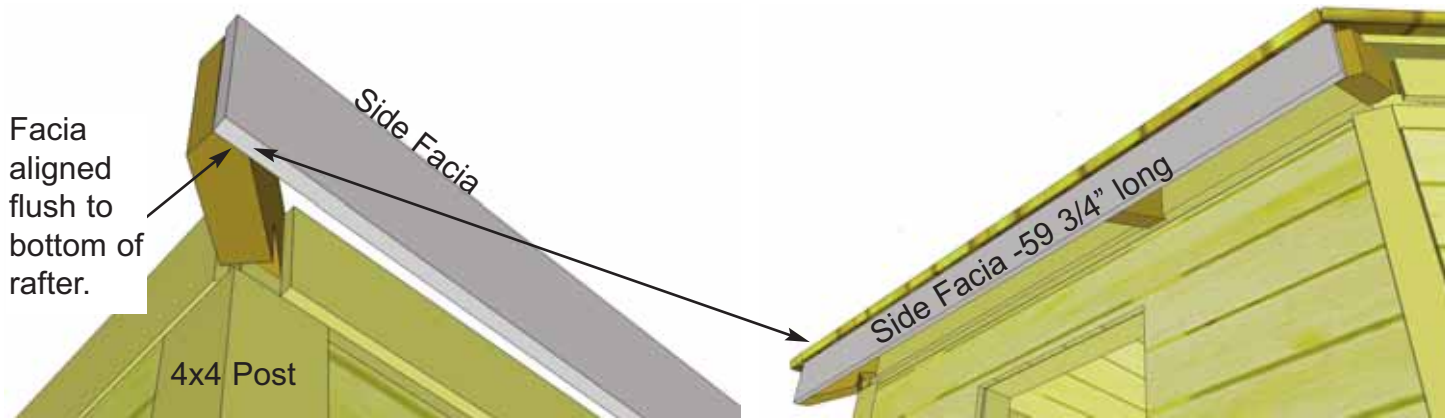

**57.** When installing Facia, start with Side Facia Board first (59 3/4" long). Align Facia on Hip Rafter in Corner so flush to bottom of rafter. Facia should sit equally on the 45 degree cut on end of rafter. On the opposite end, Side Facia should also sit flush to bottom of Front Hip Rafter and equally on angle cut on end of rafter. Tack to rafter ends with 2 - finishing nails.

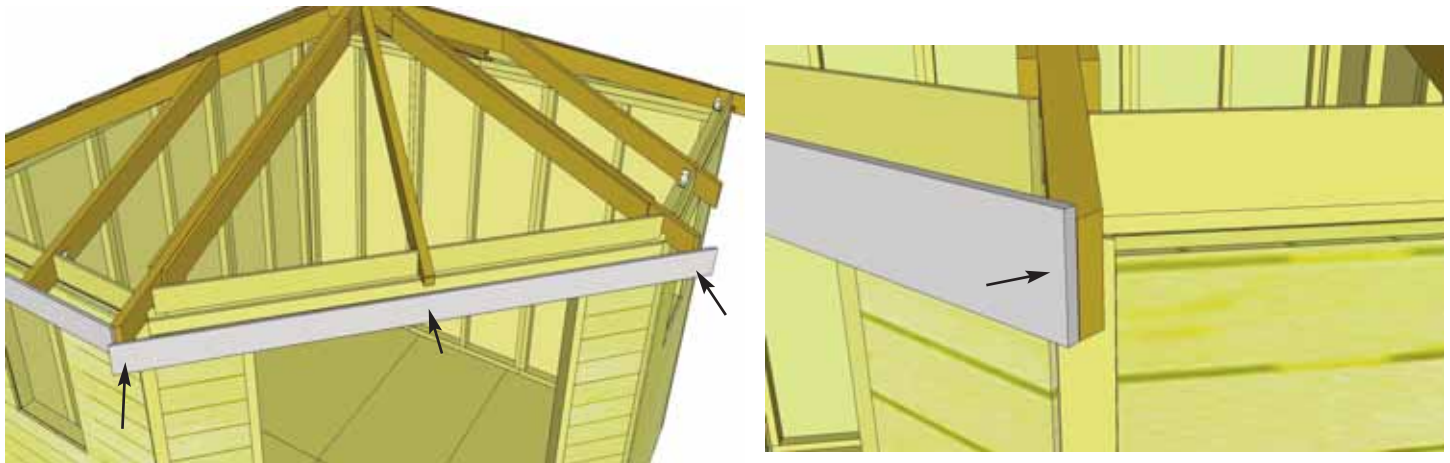

**58.** Position and attach Front Facia (85 3/4" long) to the ends of each Front Hip Rafter as per **Step 57**. Make sure to align Facia to bottom of rafter once again.

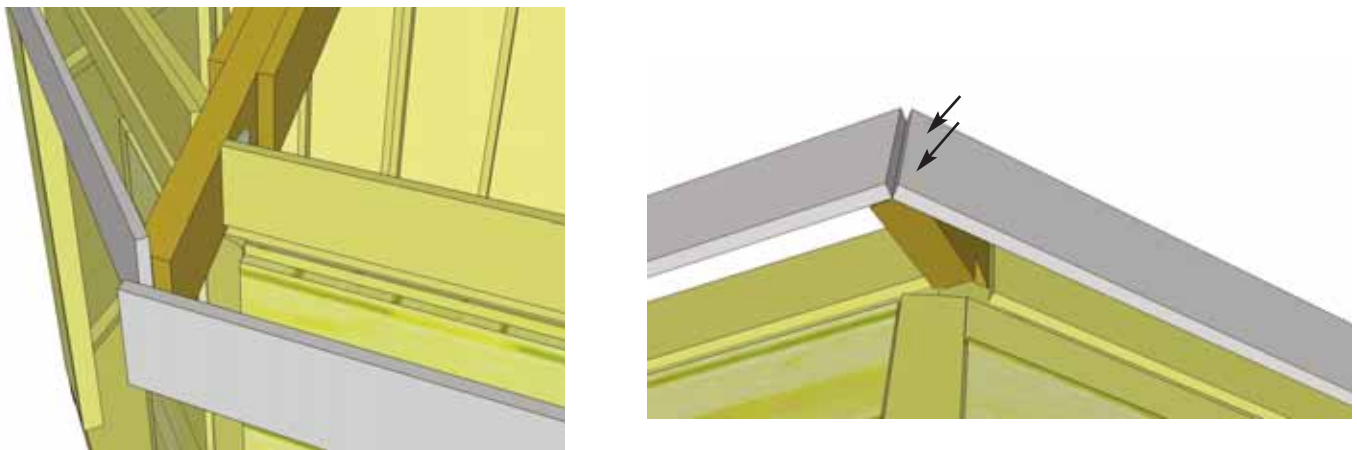

**59.** Position 2nd Side Facia (59 3/4" long) on rafter ends as per **Step 57**. If required, go back now and adjust both the Front and previous Side Facia equally on rafter ends and secure completely with 6 - finishing nails per piece. **Important:** gaps occurring in corners will be covered by Decorative Detail Facia Plates installed in **Step 85**.



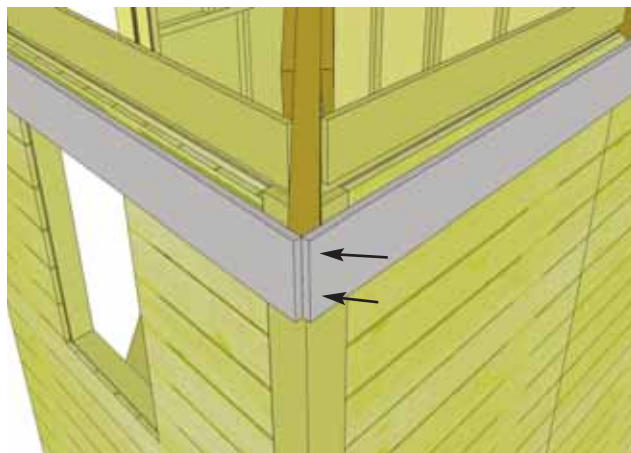

**60.** Position Rear Side Facia (60" long) on Rafter Ends so evenly spaced on both Hip and Rear Mid Rafter (See **Step 61** for illustration of Facia alignment on Rear Mid Rafter). Position Facia flush to bottom of Rafter once again and attach with 6 - Finishing nails per piece.

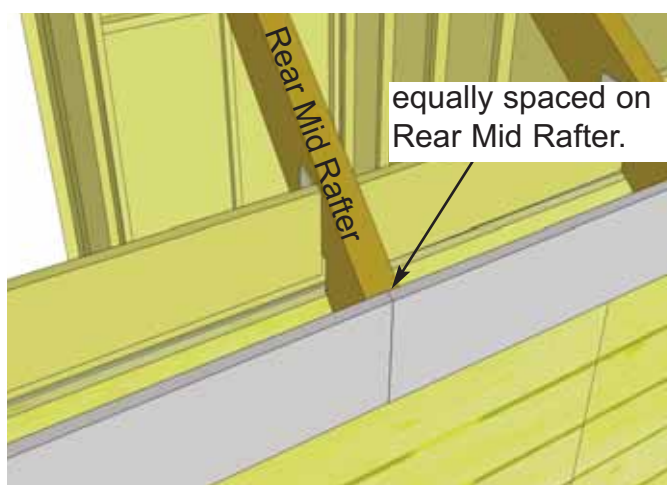

**61.** Complete 2nd Rear Side Facia as per **Step 60**.

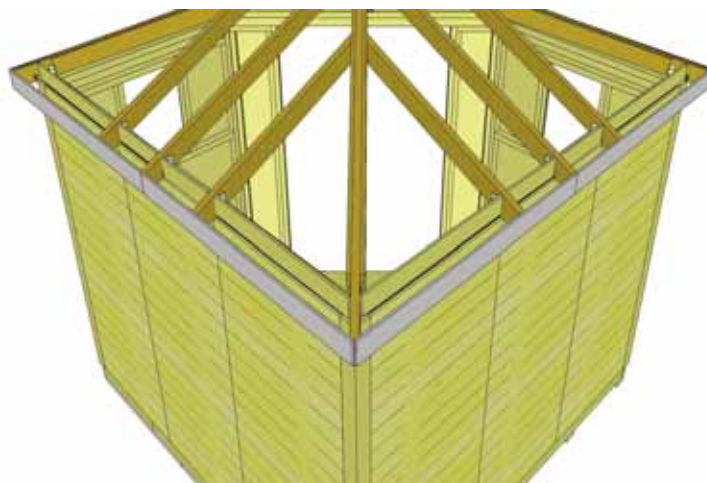
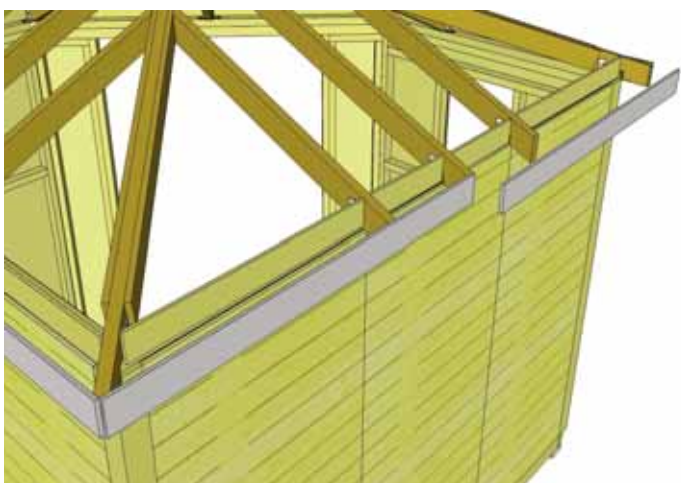

**62.** Complete remaining Rear Side Facia pieces as per **Steps 60-61**.

# D. Roof Section

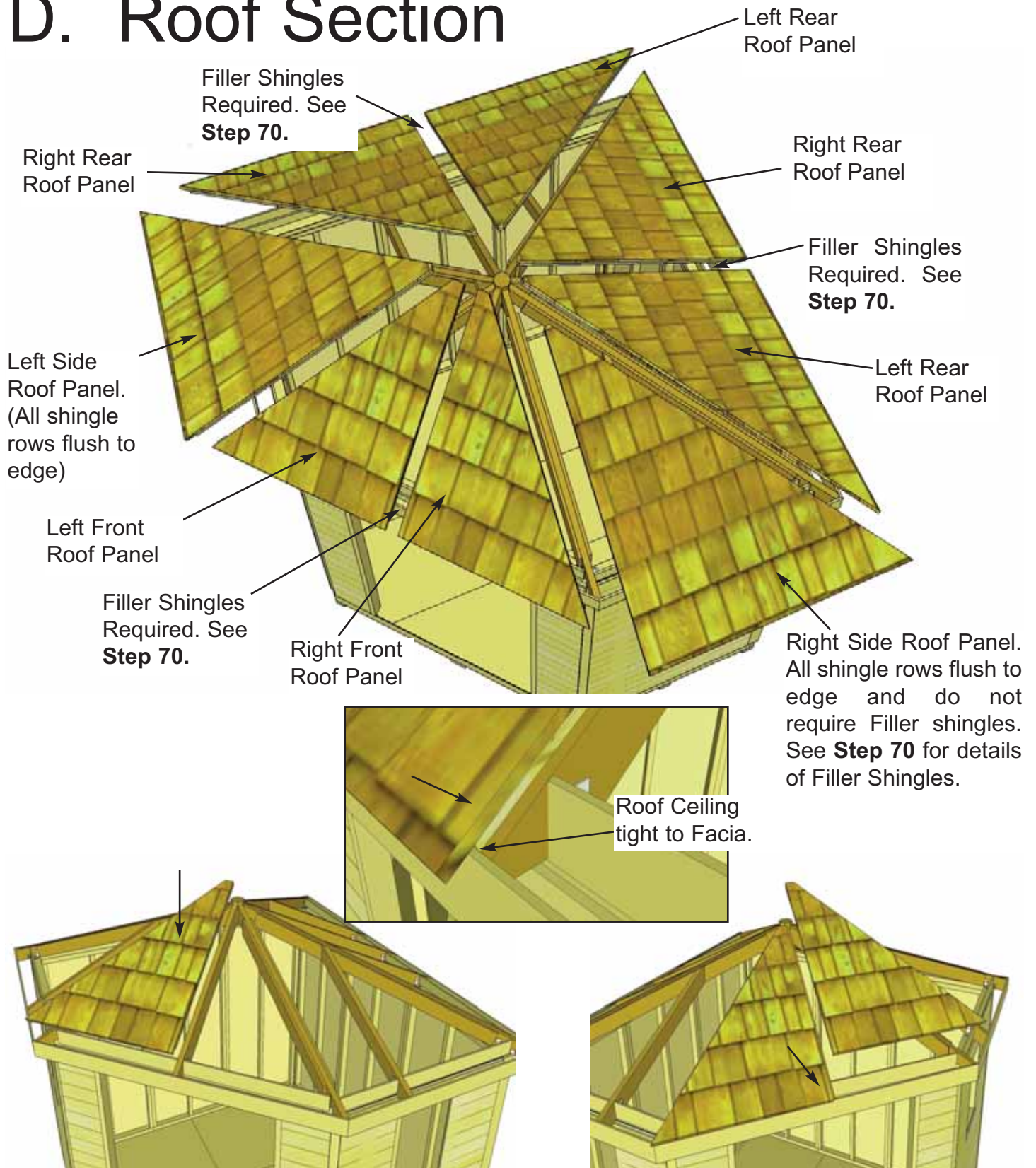

**63.** Starting with Front Roof Panels, lift and position **Left Front Roof Panel** up so it sits equally between Front Hip and Front Mid Rafter. Roof Ceiling (underside of shingle roof) will sit flush against Facia Board. When correctly aligned, secure panel to Front Mid Rafter on bottom row of shingles **Only** with 1 - 2 1/2" screw. Screw from shingle into rafter. **Important:** later in **Step 69** Roof Panels may need to be slightly re-positioned and will be completely secured to rafters at that point. Position Right Front Roof Panel in place.

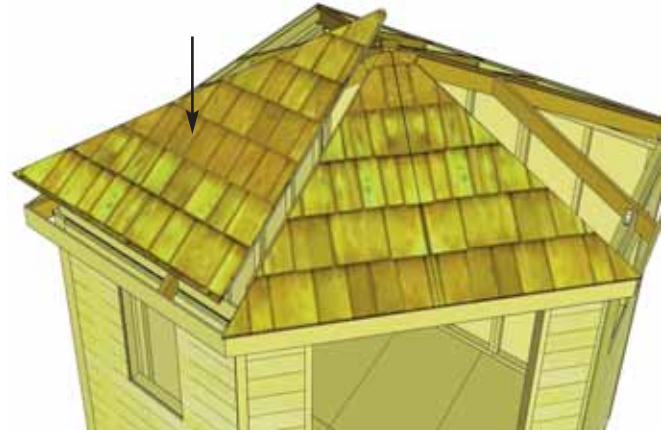
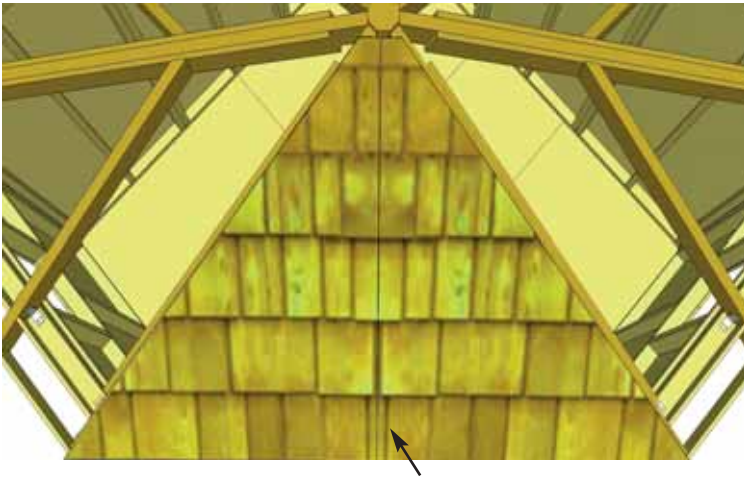

**64.** Align and attach **Right Front Roof Panel** as per **Step 63**. Place the **Left Side Roof Panel** on Front Corner and Hip Rafter as shown above.

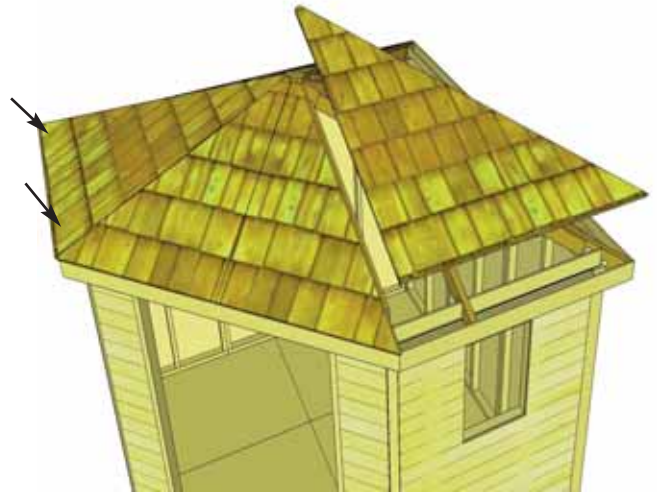
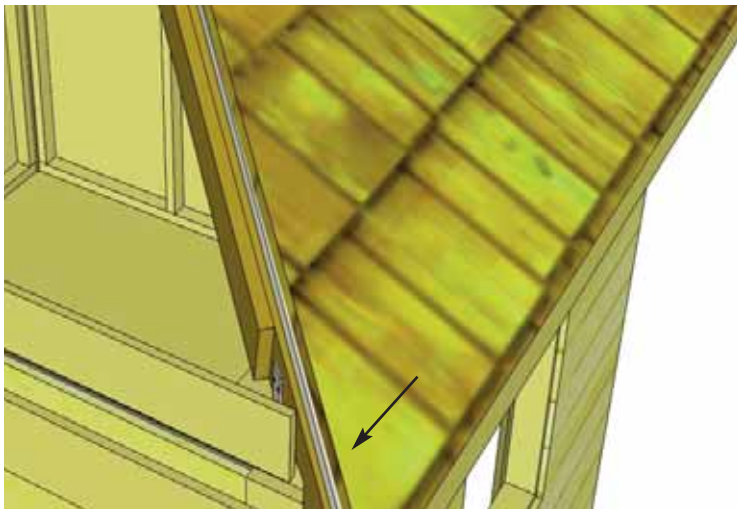

**65.** Align Left Side Roof Panel so it sits equally on both rafters and roof ceiling sits on Facia. Screw roof panel down with 2 - 2 1/2" screws in bottom row of shingles at each corner. Make sure to screw into rafters. **Screws will be covered by Ridge Caps in Step 80.**

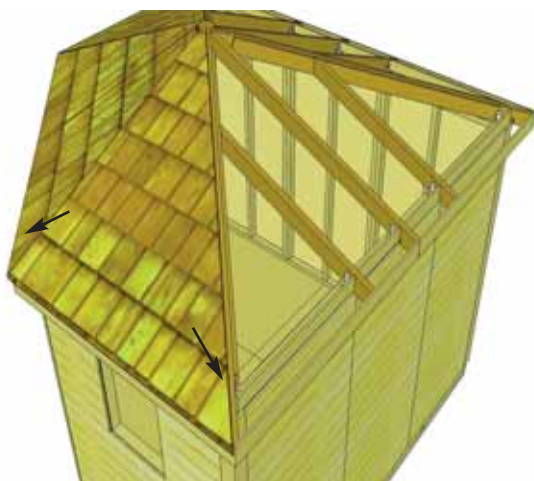

**66.** Place Right Side Roof Panel on Front Hip Rafter and align and attach as per **Step 65**.

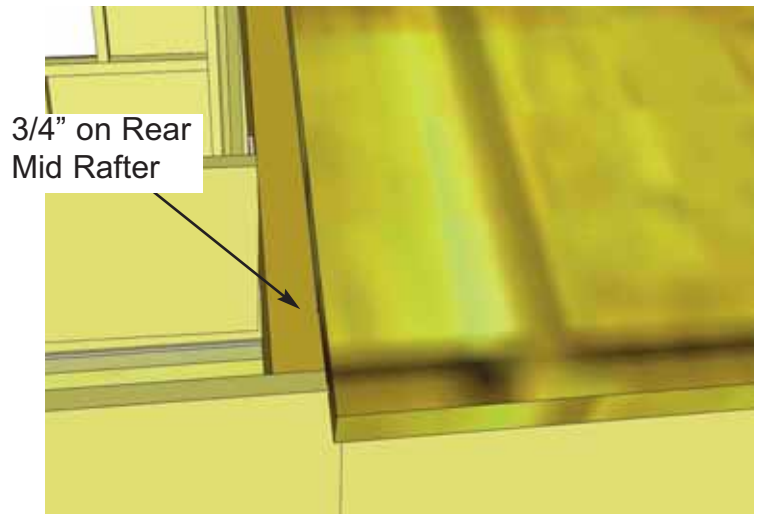
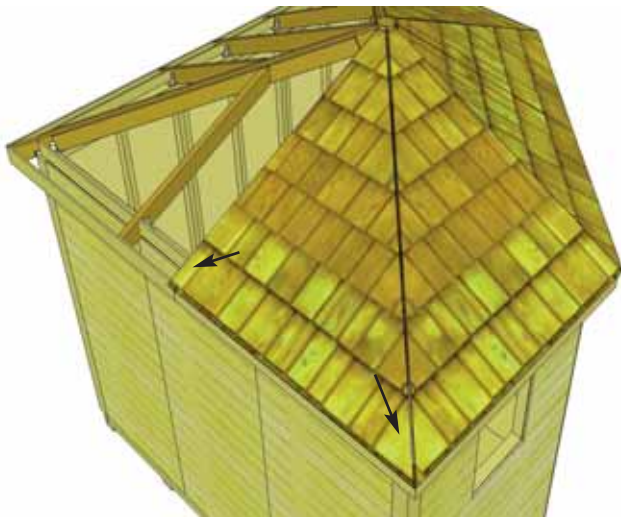

**67.** Place a Right Rear Roof Panel on Rear Mid and Hip Rafter. Center Rear Roof Panel on Rear Mid Rafter (3/4"). Any gaps in the corner will be hidden by Ridge Caps later in **Step 80**. Align and attach as per **Step 65**.

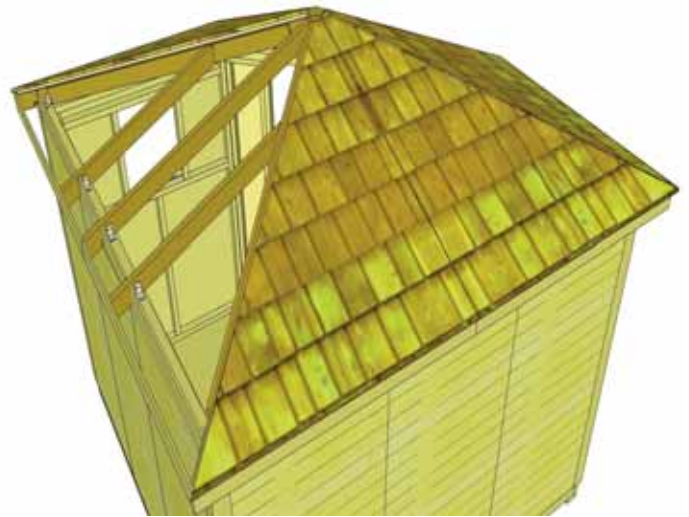
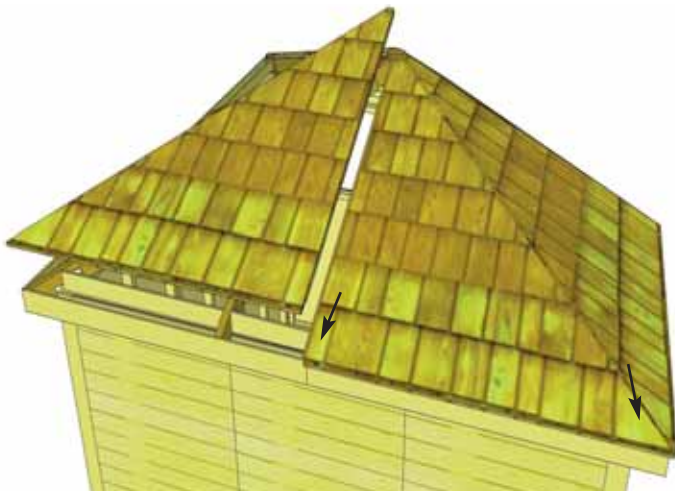

**68.** Place, align and attach a Left Rear Roof Panel on Rafters as per **Step 67**.

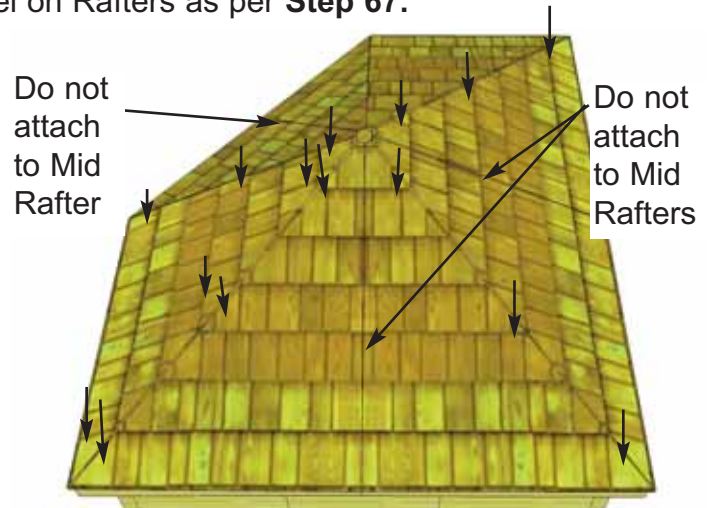
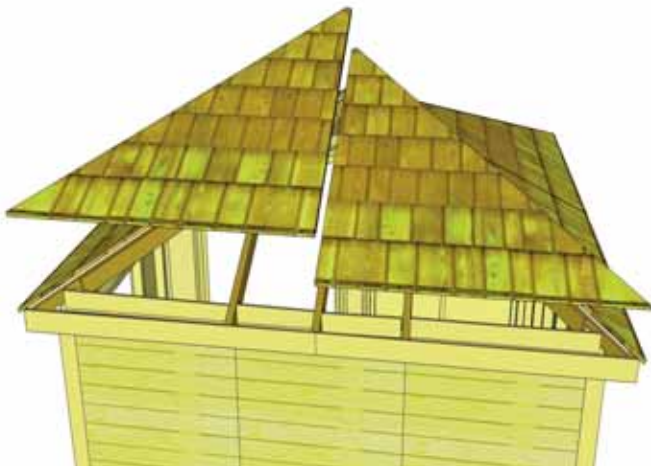

**69.** Complete final Right and Left Rear Roof Panel installations as per **Step 67**. When complete, Roof Panels may need to be slightly re-positioned. If so, loosen panel and re-attach when satisfied with position. Use 3 - 2 1/2" screws per panel on all Hip Rafters. (Do not attach Roof Panels to Mid Rafters at this point.)



**70.** Roof **Filler Shingles** are included to cover where the flat roof seams meet. There are 3 roof seams to complete. Starting at the bottom rear panel, slide the first Long Filler Shingle in until flush with bottom shingles. **SEE STEP 71 FOR ATTACHMENT.**

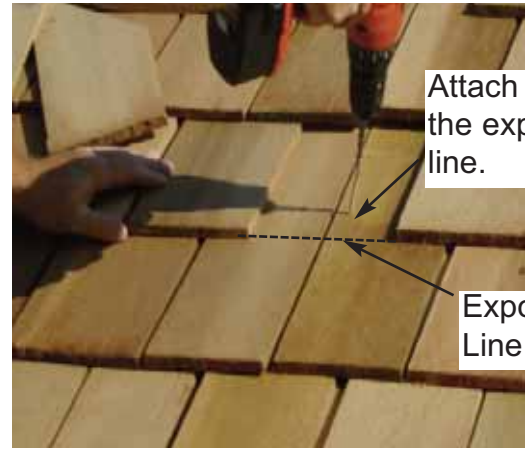

**71.** Screw first filler shingle down to rafter using 1 - 2 1/2" screw per panel (2 in total). Make sure to screw into rafter on angle.



**72.** Slide in another filler shingle and attach as per **Step 71.** On last row, slide in 1 - 14" long shingle and attach to roof with 2 - 1 1/2" shingle nails per shingle. **NOTE:** The rear panels require 5 - long Filler Shingles and 1 - 14" to complete. The Front Roofs will require 4 - Long Filler and 1 - 11" Filler Shingle to complete.

## E. Miscellaneous Section

Not Shown in Picture:  
Center Door Stop

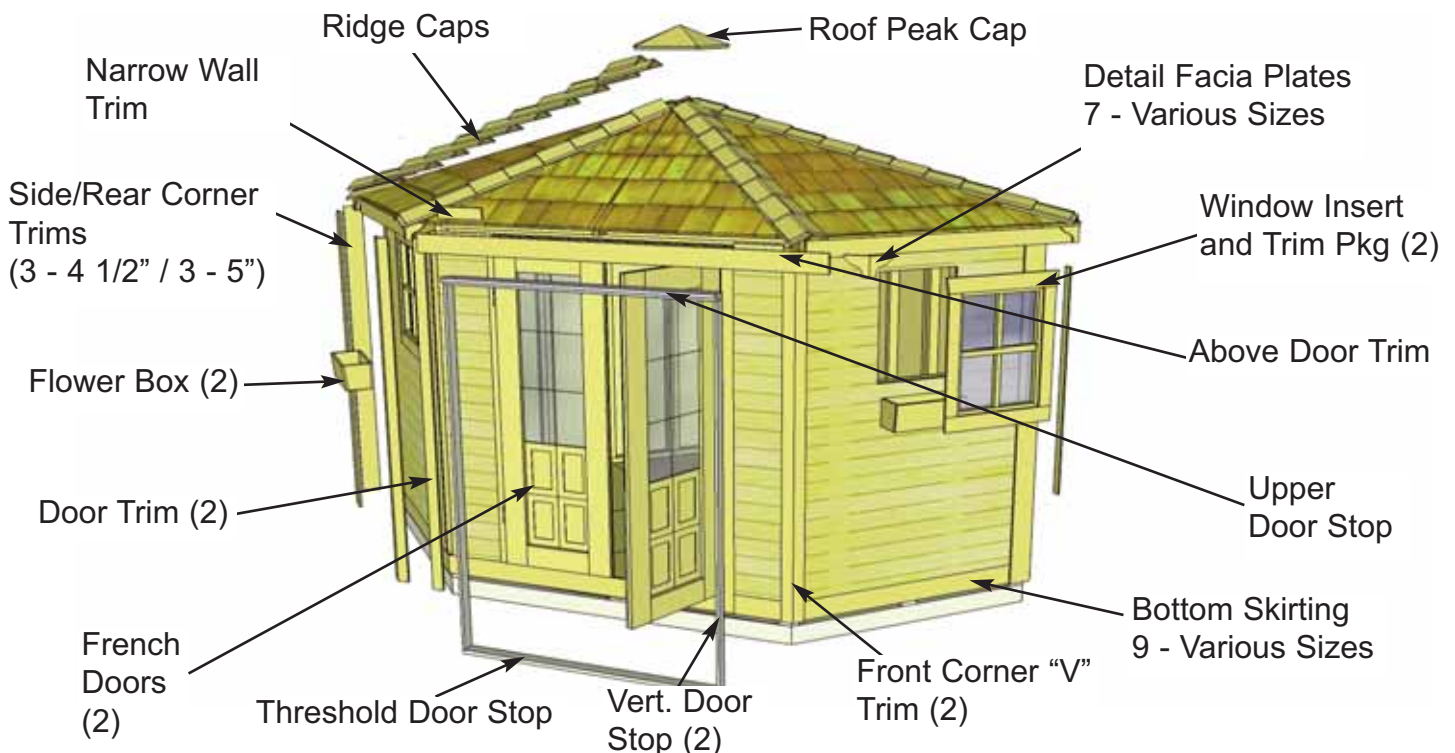



**73.** Attach **Bottom Skirting** around the base of the shed. Skirting will hide floor framing. Start with Rear and Side Skirting pieces first, The rear skirting pieces will meet where walls come together. Attach with 4 - 1 1/2" finishing nails per piece. Complete all rear wall pieces. Position Side Skirting piece in place.



**74.** Position Side Skirting Piece so it is flush with rear corner. Attach with 4 - 1 1/2" finishing nails. Position Front Skirting under doorway.

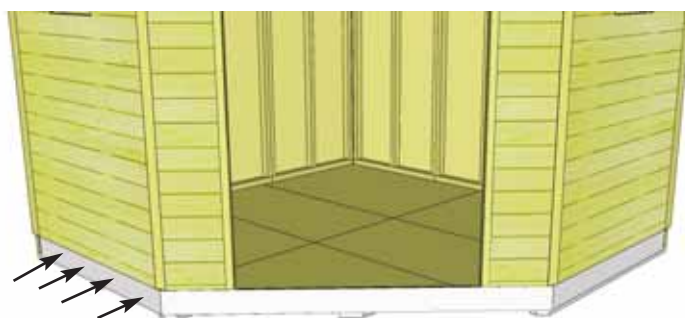
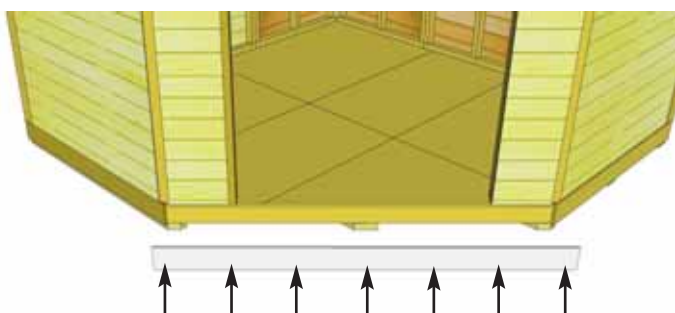

**75.** Attach Front Skirting piece using 8 - 1 1/2" finishing nails. Complete remaining Side Skirting pieces as per **Step 74**.

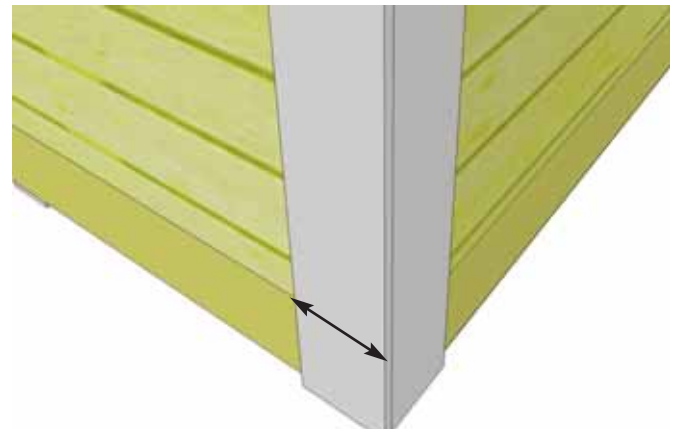
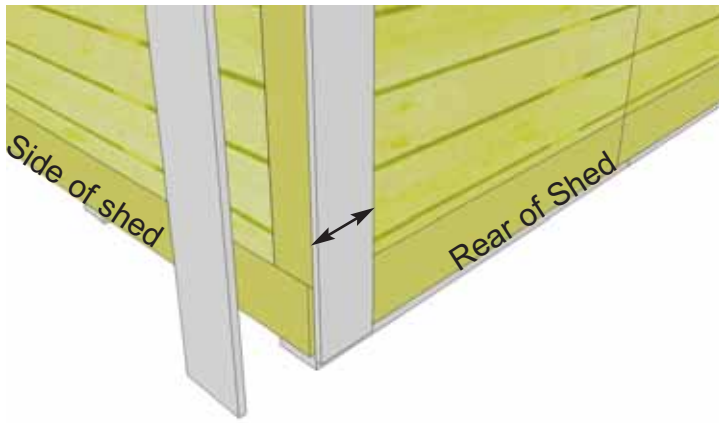

**76.** In each rear corner, locate one 4 1/2" and 5" Side Rear Corner Trim. Place narrow trim on rear wall so flush with outside of corner post and tack with 2 - finishing nails. Place wider trim on side wall flush to outside of narrow trim. When properly positioned, secure with 8 - finishing nails per piece.



**76a.** Complete remaining 2 Corners as per **Step 76**.

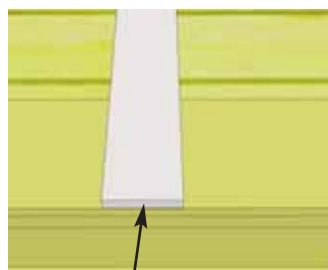

equally on both bottom skirting pieces.

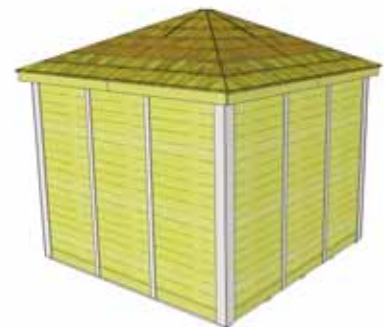

**77.** Locate 4 Rear Wall Seam Trim (2 1/2" wide). Place equally on rear wall seams and attach with 8 - finishing nails.

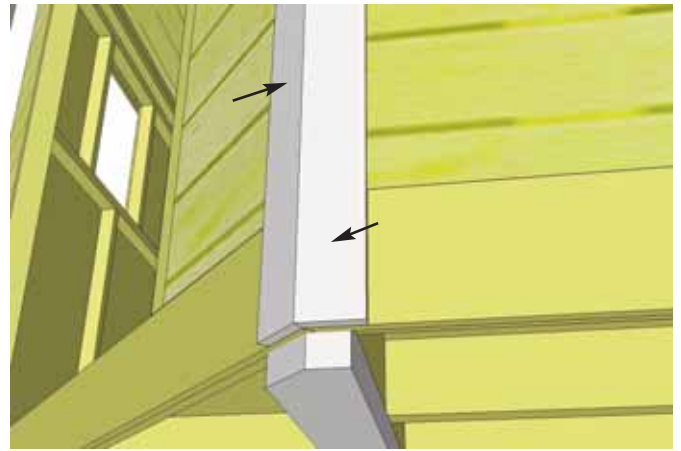
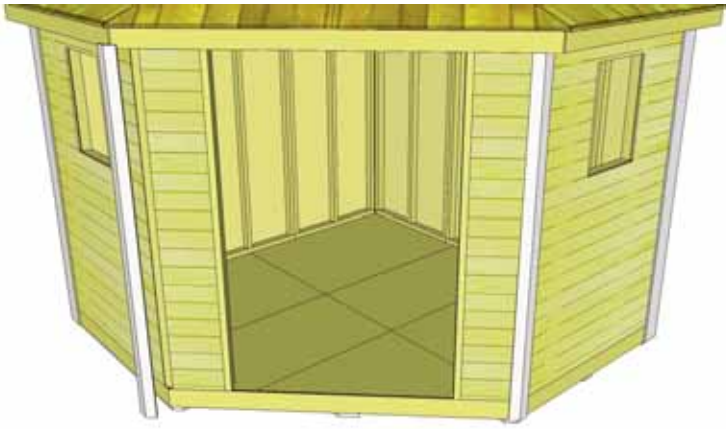

**78.** Locate both **Front Corner "V" Shaped Trims**. Place over corners in front and attach each with 8 - finishing nails.

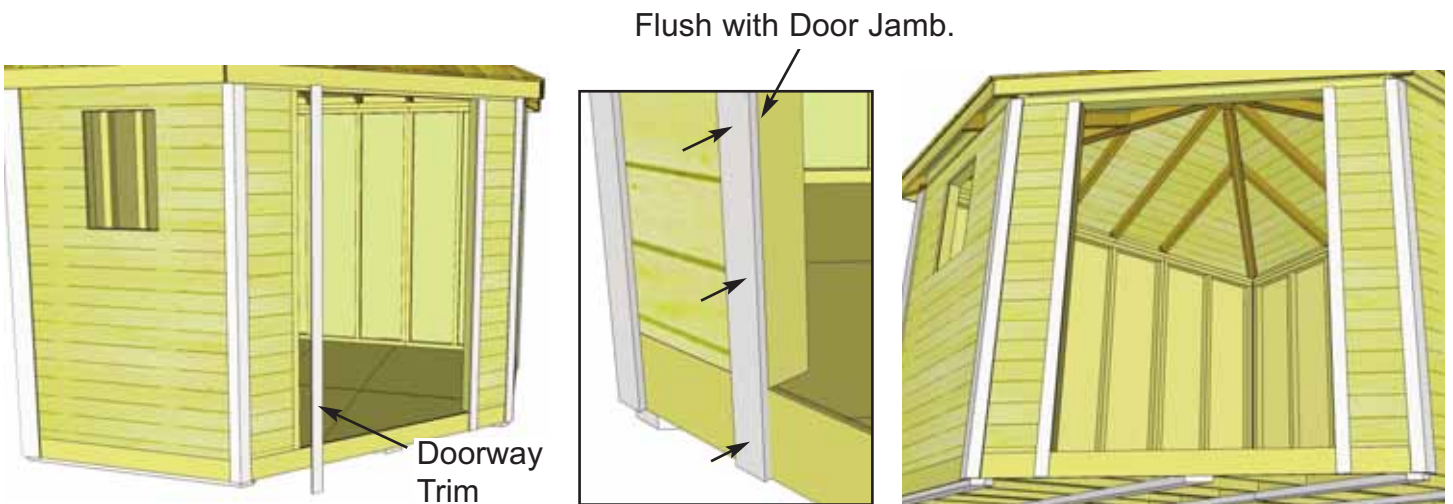

**79.** Locate both **Doorway Trims** (2 1/2" wide) and position over Door Jamb so it sits flush (see illustration above). Attach each trim with 8-10 finishing nails.

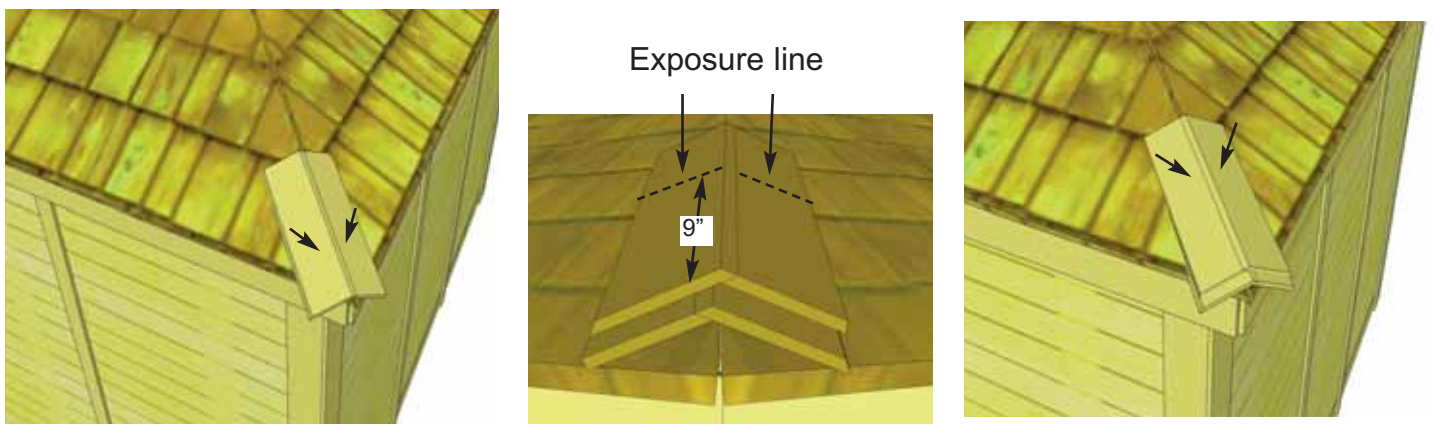

**80.** Locate all **Roof Ridge Caps**. **Note:** there are left and right offset Ridge Caps. See above for detailed illustration of the difference. Place 1st Ridge Cap on corner roof seam slightly overhanging roof end and attach with 2 - shingle nails. Locate and place 2nd Ridge Cap (offset), recessed on initial Ridge Cap. Attach above 9" exposure line with 2 shingle nails.



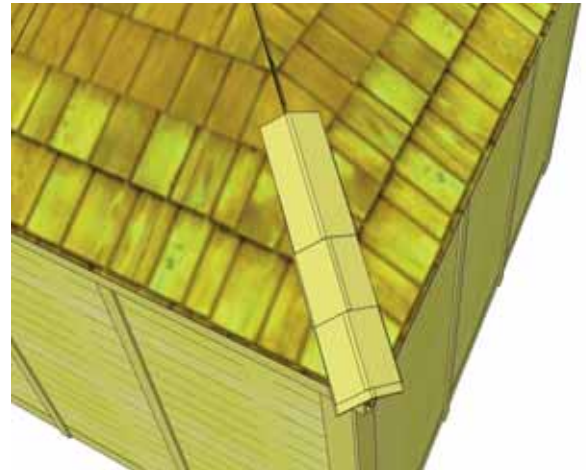
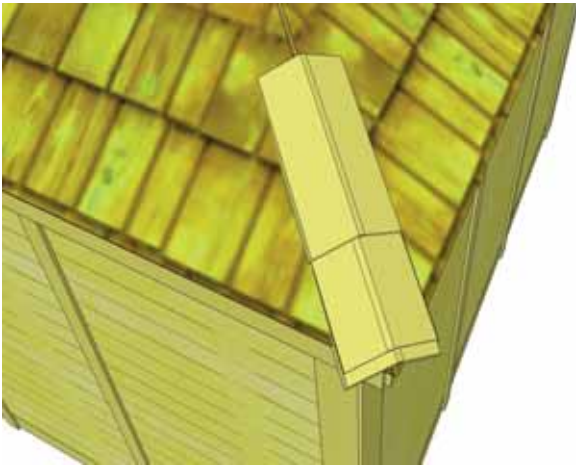

**81.** Place 3rd Ridge Cap on roof seam. Start the 3rd Ridge Cap approx 8" from bottom of 2nd Ridge Cap and attach with 2 shingle nails above the exposure line.

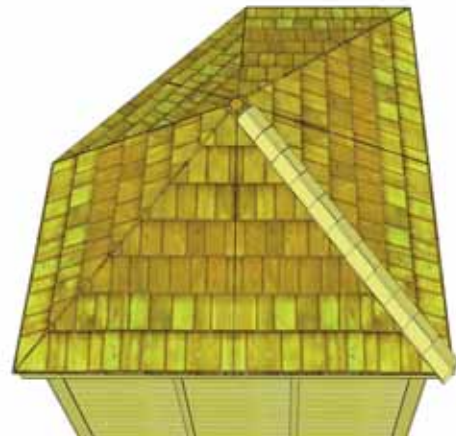
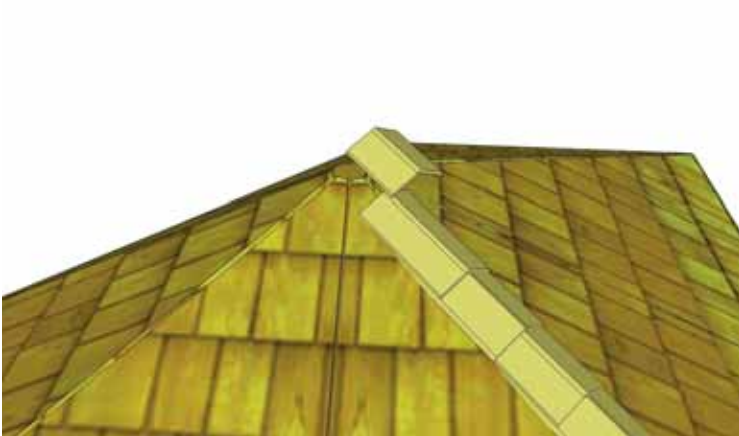

**82.** Continue to attach Ridge Caps positioning and securing as per **Step 81**. The last Ridge Cap to complete a side must be cut shorter to fit up to Core Block. Use a Utility Knife to score cap.

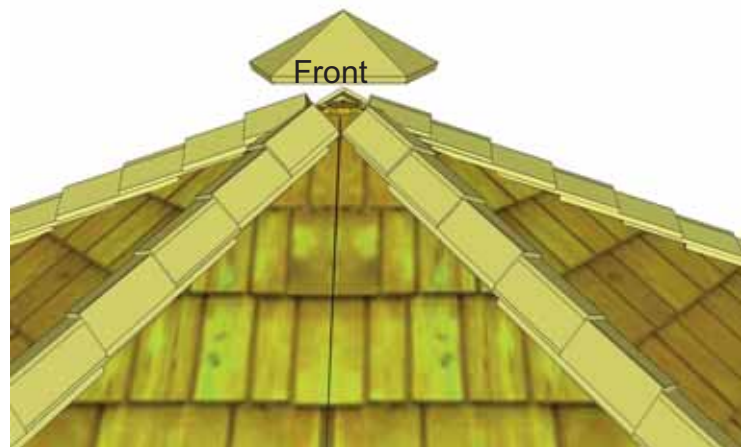
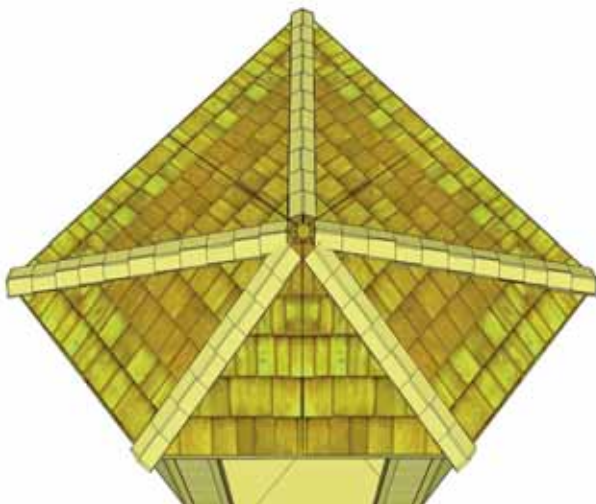

**83.** Complete attaching Ridge Caps to all corner roof seams as per **Step 80-82**. Place Roof Peak Cap on top center of shed.

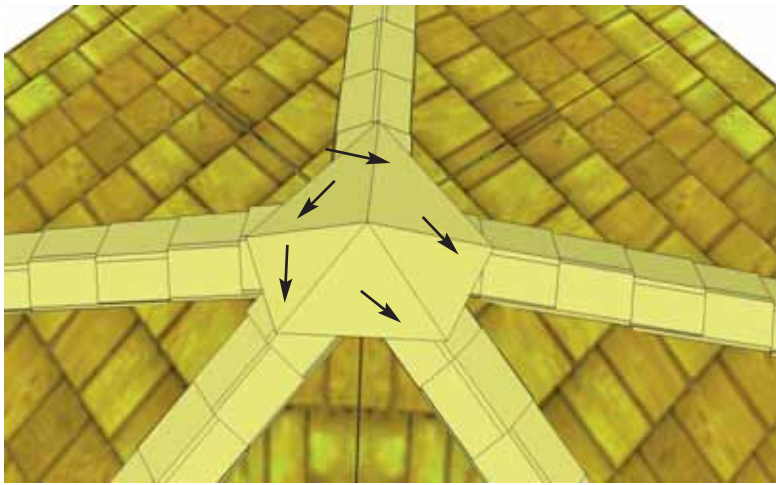

**84.** Center and secure Roof Peak Cap with 5 - 3" screws.

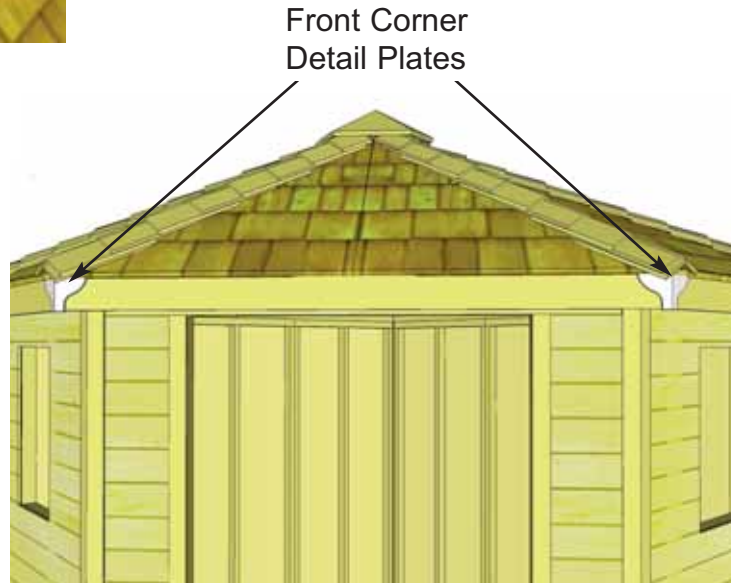
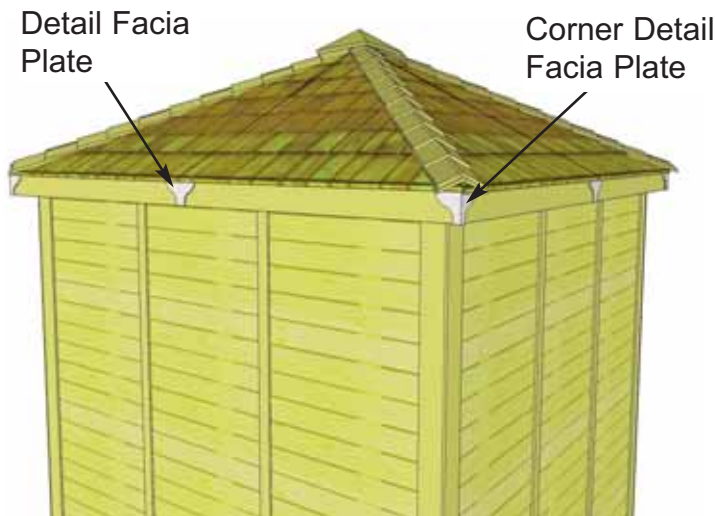

**85.** Locate Detail Facia Plates and place in each corner and where Facia Boards come together. Detail Plates will hide any gaps that may exist. Attach each Plate with 4 - finishing nails.

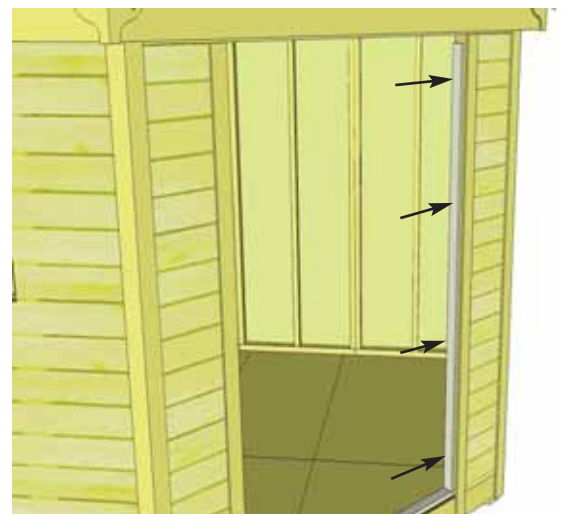
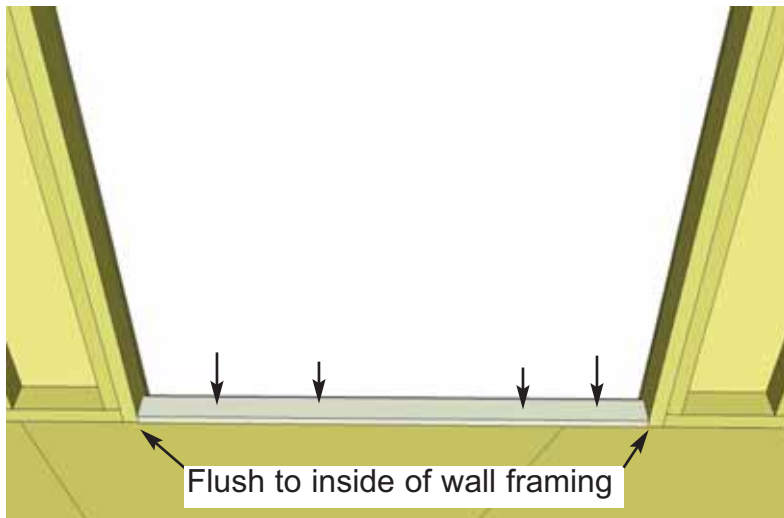

**86.** Align Threshold Door Stop (49 3/4" long) flush to inside of wall framing. If Floor Option has been purchased, screw down to plywood floor with 4 - 1 1/4" screws. Without Floor, drill into existing surface to secure (Hardware not supplied). Align Vertical Door Stop to inside of wall framing and attach with 4 - 1 1/4" screws. Complete both sides. (Prior to completing, check **Step 87** for best fit).



**87.** Align Upper Door Stop (Dado facing to outside) with other stops and attach with 4 - 2" screws.

**Note:** illustration of Hinge may not be accurate. The # of screw holes in the hinge may vary from three to four depending on model.

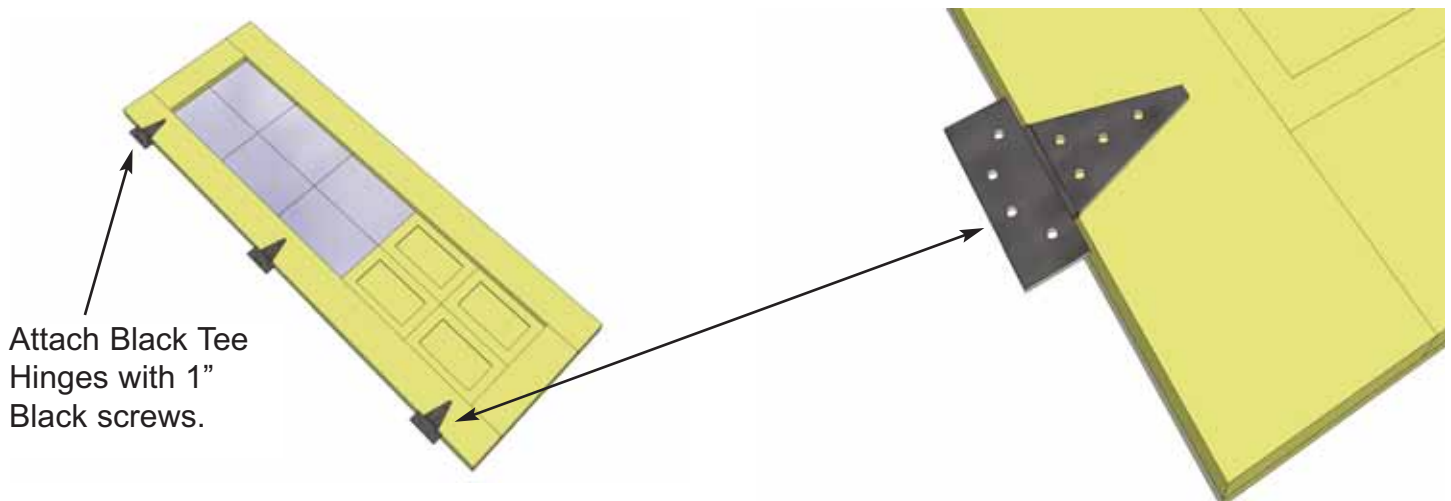

Attach Black Tee Hinges with 1" Black screws.

**88.** Attach Door Hinges to both **Left** and **Right Side Double French Doors**. Position Hinges equally on door as shown above and attach with Black 1" screws. **Note:** Pre-drill holes for hinges to prevent splitting.

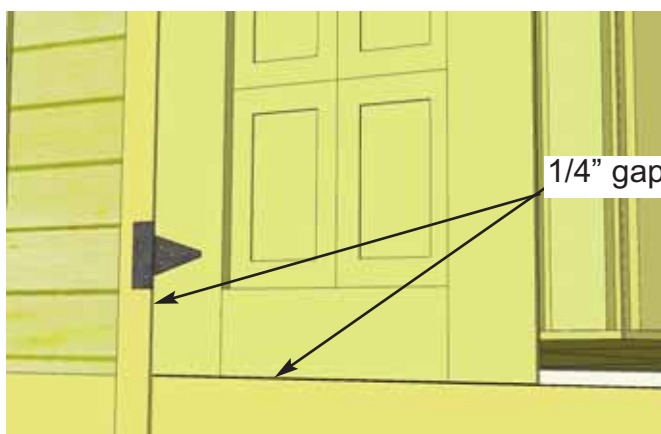

**89.** Position and secure the Double Doors. Starting with **Left Side Door**, position so there is a 1/4" gap on bottom and approximately 1/4" on the side. Use the extra piece of **Filler Shingle** to shim door in place at the bottom and side. Using 2" black screws, secure hinges to Door Trim. **Hint:** Do not attach all the 2" screws until both doors are positioned correctly. Use Screw Driver to tighten screws completely.

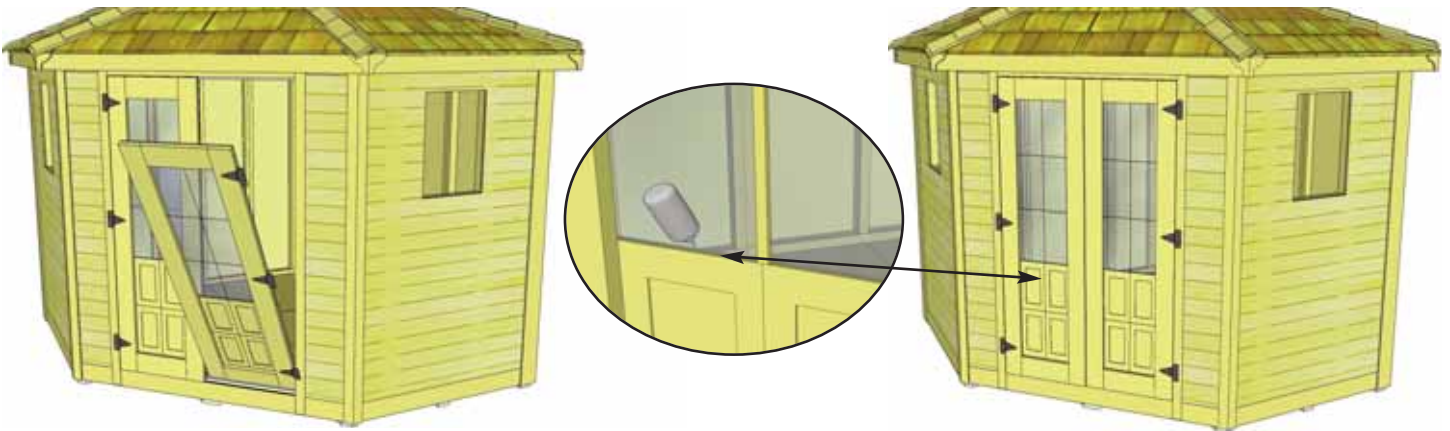

**90.** Position **Right Side Door** as per **Step 89** and secure with 2" Black Screws. When satisfied with door positioning, complete all 2" screws. **Note:** Do not over tighten hinge screws when using screw gun. **Optional:** Using a hand tube of clear silicon caulking, apply caulking across bottom of window frame and up both edges vertically for 1". This will decrease the chances of water penetration at bottom of window.

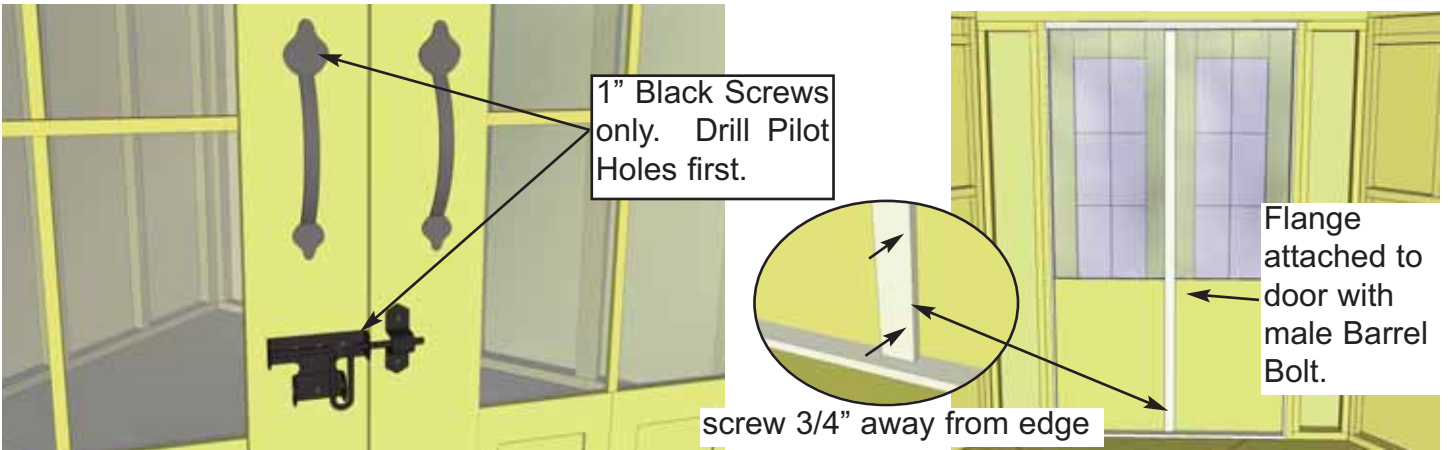

**91.** Attach **Door Handles**, **Exterior Barrel Bolt** and **Center Door Stop** to doors. Handles are attached equally on both doors with 1" black screws. Attach Black Barrel Bolt as illustrated above with 1" Black Screws. Note how female part of Barrel Bolt is positioned higher than male. Do a dry run first to position Barrel Bolt correctly. **Important:** Drill pilot holes with 1/8" drill bit prior to securing with screws to prevent wood splitting. Male Barrel Bolt piece will be positioned on Door least commonly opened (our example shows left door). From the inside, install Center Door Stop on Door with male Barrel Bolt. Align Stop so there is 3/4" overlap in door opening. Attach with 6 - 1 1/4" screws evenly spaced. **Make sure to drill pilot holes in Door Stop and Door to prevent splitting.**

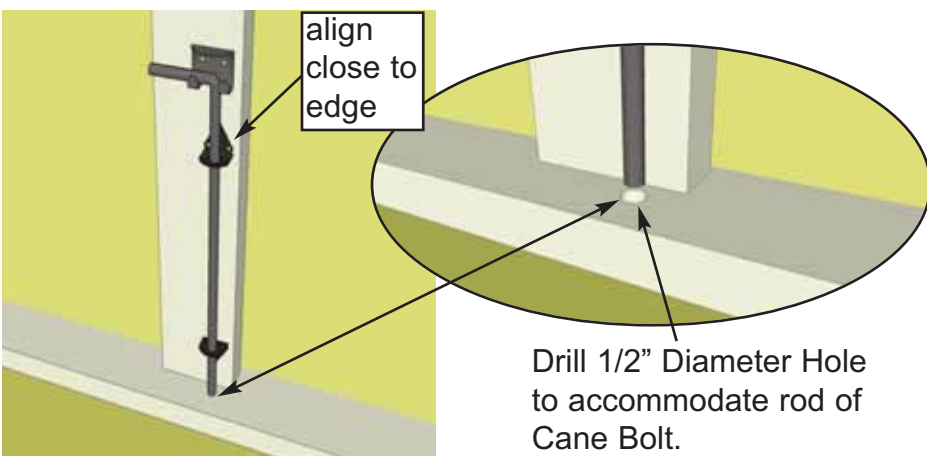

**91a.** The **Interior Cane Bolt** will be attached to Interior Door Flange. To position Cane Bolt correctly, attach to flange first, close doors and mark hole to house Cane Bolt Rod. Open doors and drill hole where previously marked with 1/2" bit. Attach with Black 1" Screws **Important:** Drill 1/8" pilot holes to prevent wood from splitting.

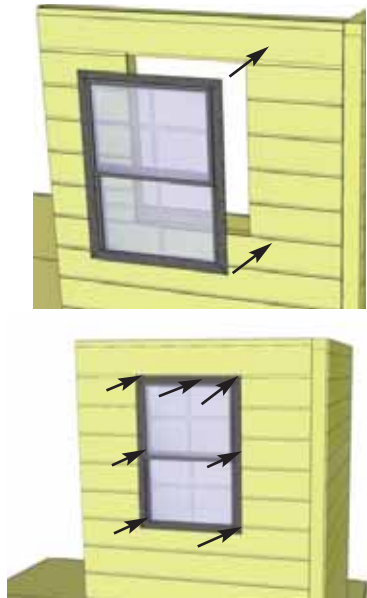
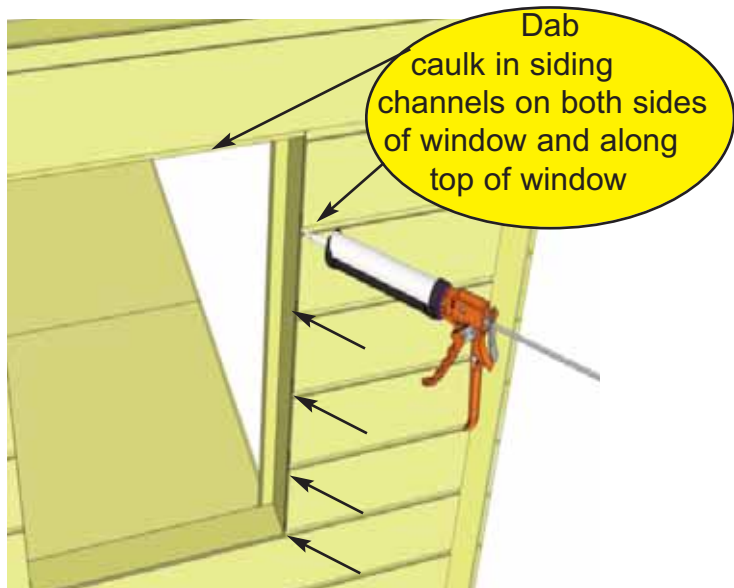

**92.** Locate **Window Inserts for Window Walls.** Before installing, dab caulk in siding channel on both sides and across top of window opening. This will prevent water from getting in behind window. Position window in cavity and secure with 8 - 1 1/4" screws. Window Trims will hide caulking.

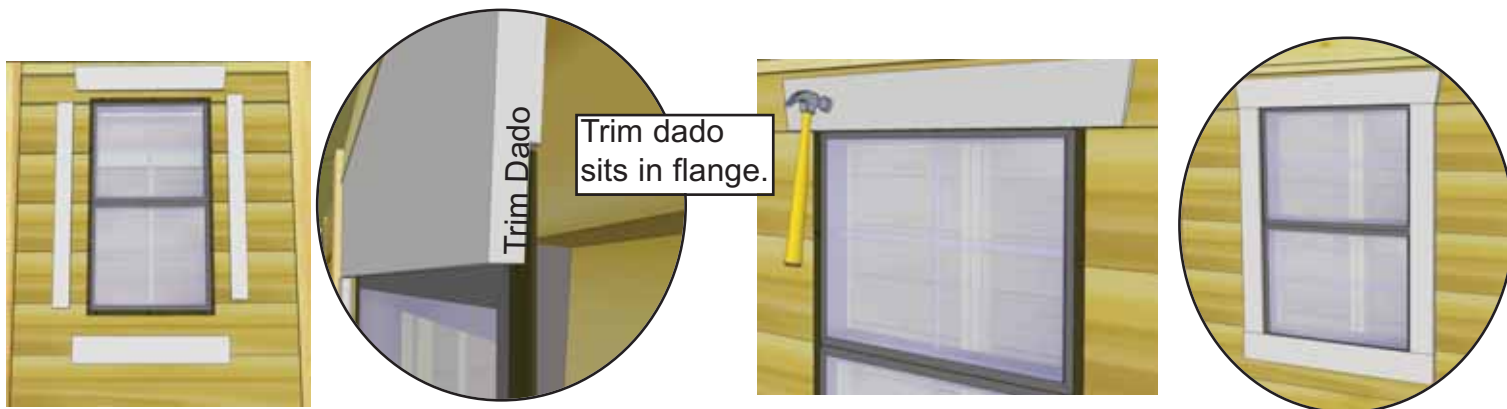

**92a.** Position Window Trim around window doing a dry run first and attach with 4 - 1 1/2" finishing nails per piece. The window kit trim pack = 1x 24 1/16" = top / 3 x 23"= sides and bottom. Window trim has a small dado on reverse face. Outside flange of window will roughly sit in the dado to give a better fit.

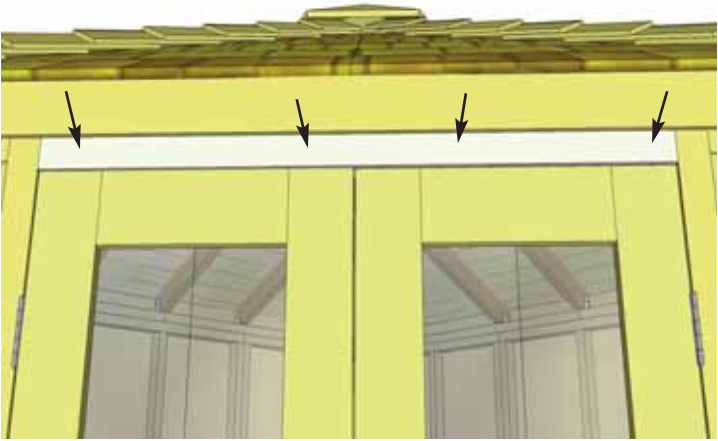

**93.** Position and attach **Above The Door Trim** and **Narrow Wall Trims** to front of shed above doors and to narrow walls to cover wall framing. Use 4 - finishing nails above the door and 2 for narrow walls.



**94.** Assemble **Flower Box Kit** with Assembly Instructions included. Position completed Flower Box below bottom of window trim and secure with 2 - 2 1/2" screws. Screw from inside of box into the center wall stud. Attach second screw 2" underneath first screw and once again into the wall stud. Install Flower Box Kits underneath each window.



**Congratulations on assembling your Penthouse Garden Shed! We hope the experience has been both positive and rewarding.**



We value your feedback and would like to hear back from you on how well we are doing in the following areas:

- 1. Customer Service**
- 2. On Time Shipping**
- 3. Motor Freight Delivery**
- 4. Quality of Materials**
- 5. Assembly Manual**
- 6. Overall Satisfaction.**

**Note:** Our Sheds are shipped as unfinished products. If exposed to the elements, the western red cedar lumber will weather to a silvery-gray color. If you prefer to keep the cedar lumber looking closer to the original color, we suggest that you treat the wood with a good oil base wood stain. You may also wish to paint your new shed rather than stain it. In both cases we recommend that you consult with a paint and stain dealer in your area for their recommendations.

Please call, write or email us at:

Outdoor Living Today

Canadian Address  
9393 287th Street  
Maple Ridge, British Columbia  
Canada V2W 1L1

United States Address  
P.O. Box 96  
Sumas, Washington  
USA 98295



The materials contained in this Assembly Manual may be downloaded or copied provided that ALL copies retain the copyright and any other proprietary notices contained on the materials. No material may be modified, edited or taken out of context such that its use creates a false or misleading statement or impression as to the positions, statements or actions.