

Parts Identification

Wood Components

(NOT TO SCALE)



- (2) **D1 - JOIST - W4L04585**
1 3/8"x5 1/4"x114" (36x134x2896)



- (2) **D2 - JOIST - W4L04590**
1 3/8"x5 1/4"x114" (36x134x2896)



- (8) **D3 - SLOTTED JOIST - W4L04586**
1 3/8"x5 1/4"x114" (36x134x2896)



- (2) **D4 - JOIST - W4L04587**
1 3/8"x5 1/4"x90" (36x134x2286)



- (2) **D5 - JOIST - W4L04591**
1 3/8"x5 1/4"x90" (36x134x2286)



- (12) **D6 - JOIST END - W4L04588**
1 3/8"x5 1/4"x15" (36x134x381)



- (4) **D7 - JOIST END - W4L04592**
1 3/8"x5 1/4"x15" (36x134x381)



- (4) **D8 - LONG ANGLE BRACE - W4L04593**
1 3/8"x5 1/4"x37 1/8" (36x134x942)



- (4) **D9 - SHORT ANGLE BRACE - W4L04594**
1 3/8"x5 1/4"x29 3/4" (36x134x755)



- (12) **P1 - LONG PURLIN - W4L04589**
1 3/8"x1 3/8"x76 5/8" (36x36x1945)



- (12) **P2 - SHORT PURLIN - W4L04595**
1 3/8"x1 3/8"x59 1/4" (36x36x1504)

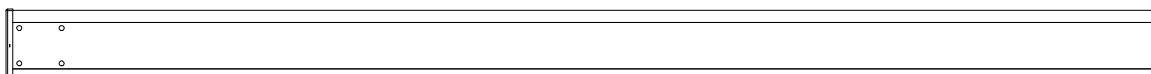

- (4) **WP1 - PERGOLA POST - W4L04584**
5 1/2"x5 1/2"x89 1/2" (140x140x2273)

Parts Identification

Hardware

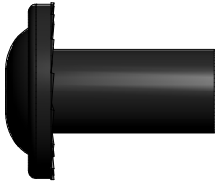

(34) VK - NUT BARREL WH 5/16x7/8 BLK - H100192

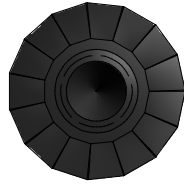

(34) VL - NUT BARREL WH 5/16x1-1/2 BLK - H100193

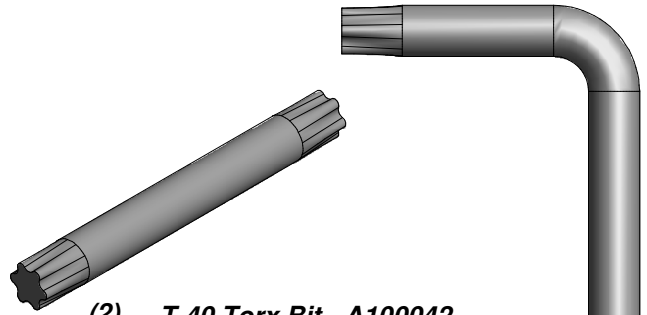
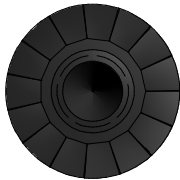

(2) - T-40 Torx Bit - A100042

(2) - T-40 Torx Wrench - A100041

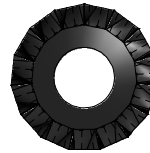

(76) VR - WASHER LOCK EXT 8x19 BLK - H100198



(2) VW - SCREW PFH 8x1/2 BLK - H100203



(17) VT - SCREW PFH 8x1-1/2 BLK - H100200



(100) VU - SCREW PFH 8x2-1/2 BLK - H100201



(52) VS - WASHER LOCK EXT 12x19 BLK - H100199



(9) VZ - LAG SCREW WH 5/16x3 BLK - H100206



(2) VV - SCREW PWH 8x5/8 BLK - H100202



(18) VX - LAG SCREW WH 5/16x5-1/2 BLK - H100204



(18) VM - BOLT WH 5/16x2-1/2 BLK - H100194



(17) CQ - CONCRETE ANCHOR 3/16x2" - H100120



(34) VP - BOLT WH 5/16x7-1/4 BLK - H100196

Parts Identification
Accessories
(NOT TO SCALE)



(4) HT - FOOT 142 SQUARE POST - A100029



(1) VJ - LTP ID TAG (SMALL) WITHOUT AGES - A100387

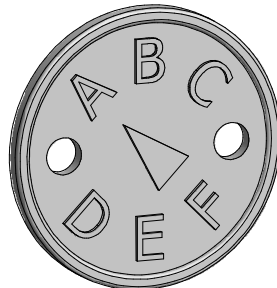

(1) SQ - "A" REVISION TAG - A100314