

# SMOKE HOLLOW

Outdoor Leisure Products

## Assembly and owner's manual

Smoke Hollow Model

30162E

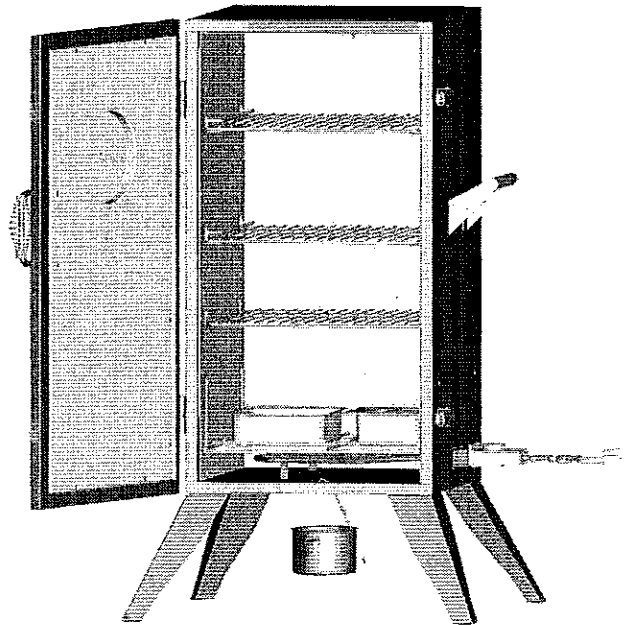

❖ Important safeguards	❖ Warning
<ul style="list-style-type: none"><li>▪ Household type.</li><li>▪ Do not immerse in water .</li><li>▪ Unplug from outlet when not in use before cleaning.</li><li>▪ Do not move smoker while unit is hot.</li></ul>	<ul style="list-style-type: none"><li>▪ Outdoor use only.</li><li>▪ Keep extension cord connection dry and off the ground.</li><li>▪ Do not touch hot surfaces during use.</li><li>▪ Do not use smoker when raining.</li><li>▪ Read all of these instructions and keep them in a safe place for future reference.</li></ul>
<p>❖ Failure to follow these instructions could result in fire, electric shock, personal injury or death.</p>	



Outdoor Leisure Products, Inc.

5400 Doniphan Drive

Neosho, Mo 64850

Toll Free: 866-475-5180

Website: [www.olp-inc.com](http://www.olp-inc.com)

8:30am to 4:30pm, Central Time  
Monday through Friday

## Save this manual and read all instructions and warnings!

### Warnings

❖ Read and follow all assembly and operating, care and maintenance instructions in this manual to avoid personal injury or property damage. The purpose of this symbol(❖) is to call your attention to possible hazards as you assemble and use your smoker. Please pay close attention to the information that follows the symbol.

- This smoker is designed for outdoor use only. Do not operate this smoker indoors or in an enclosed area.
- Keep this smoker away from swimming pools, hot tubs, etc. Do not use this smoker in the rain or on wet surfaces. If the smoker has been exposed to moisture can result in electric shock.
- To protect against electrical shock do not immerse cord, controller, plug or heat element in water or any other liquid.
- Do not touch hot surfaces, Use handles or knobs, Do not leave smoker unattended when in use.
- Smoker should be placed in an area where children and pets cannot come into contact with it. When in use, close supervision should be used.
- To prevent accidental electric shock, this smoker should always be used on a GFCI (Ground Fault Circuit Interrupter) outlet or circuit. do not plug this appliance into an indoor circuit.
- Always use a 3-wire grounded outlet wired for 120 volts which is GFCI protected at 15 or 20 amps. If in doubt, contact a qualified electrician. Do not operate any other appliances or electrical devices on the same circuit as the smoker.
- Proper clearance of 5 feet between the smoker and combustible material should be maintained at all times when this smoker is in use.
- Do not place on or near a hot gas or electric burner, or in a heated oven.
- Use smoker on hard, level, non-combustible, stable surface (concrete, ground, etc.). Never use smoker on wooden or other surfaces that could burn.
- A drip pan, ash guard or mat designed for use with smokers for easy clean up of drippings that can cause discoloration or surfaces will not prevent fires from occurring on wooden or other combustible surfaces.
- For household use only. Do not use this product for other than its intended purpose.
- Before plugging unit into electric outlet, smoker should be completely set up with wood in place, liquid in water pan and food on grills. Always unplug the cord from the outlet when finished cooking.
- Smoker should be located in an outdoor area that is protected from the wind.
- The use of accessory attachments not recommended by the appliance manufacturer may cause injuries
- Do not use an extension cord unless absolutely necessary. If you must use an extension cord, the following precautions should be used:
  - Use the shortest length possible 12/3 or 14/3 grounded-type extension cord with a rating of at least 15 amps.

## Save this manual and read all instructions and warnings!

### ✱ Warnings

- The cord should be marked with suffix letter “W-A” and with a tag stating “Suitable for Use with Outdoor Appliances.”
- Keep cord connection dry and off the ground. Do not allow cord to touch hot surfaces and place it in such a manner so it will not be tripped over or tugged on by children or pets.
- Do not operate this smoker if:
  - The cord or plug is damaged.
  - The electric element has been damaged in any manner.
  - The smoker has malfunctioned.
  - The smoker has been exposed to moisture or if grease and drippings were not cleaned from the element after each use. Refer to “Care and Maintenance” section of this manual.
  - The GFCI circuit trips when the electric element is plugged into the electric outlet.
- Extreme caution must be used when moving an appliance containing hot oil or other hot liquids.
- Use caution when reaching into or under smoker. Always wear oven mitts/gloves to protect your hands from burns. Avoid touching hot surfaces.
- Use extreme caution when adding liquid to the water pan being careful not to spill any liquid onto the electric element. Follow instructions in “Adding Water During Cooking” section of this manual.
- Water pan should always be used when smoking. Do not allow liquid in water pan to completely evaporate. Check water pan periodically and add water if level is low. Follow instructions in “Adding Water During Cooking” section of this manual.
- Always attach plug to appliance first, then plug cord into the wall outlet, to disconnect, turn any control to “off”, then remove plug from wall outlet.
- Unplug the smoker from electric outlet when not in use. Allow smoker to cool completely before cleaning. Make sure embers, coals or ashes are completely extinguished in a non-combustible metal container.
- Do not use smoker if the electric element has been exposed to moisture. Do not clean electric element with a water spray or the like. Failure to adhere to this safety warning could result in the electric element shorting out and in some cases, exploding. Clean the electric element as instructed in the “Care and Maintenance” section of this manual.
- Use caution when assembling or operating your smoker to avoid cuts and scrapes from sharp edges of metal parts.
- Store the smoker indoors in a dry location that is out of the reach of children.
- Use caution when lifting or moving the smoker to avoid strains and back injuries.
- We recommend that you have a fire extinguisher designed for use with electrical appliances on hand. Consult your local authority to determine the proper size and type of fire extinguisher.
- **Failure to follow safety warnings and guidelines in this manual could result in personal injury or property damage.**

# Electric Smoker Assembly Instructions

## Assembly Step 1- Identifying 30162E parts

**Check your package contents for these parts, make sure you have all of the parts listed below. If not, please call us at 866-475-5180**

### Hardware bags(30162E):

- |   |  |
|---|--|
| <p>A: 1/4-20x5/8" bolts(8)<br/>Part no: C016</p> <p>B: 10-24 x1" bolts(4)<br/>10-24 flange nuts (2)<br/>Part no: C017</p> | <p>D: 10-24 x1/2" bolts(2)<br/>10-24 flange nuts (2)<br/>Part no: C019</p> <p>E: 6-32 x3/8 " bolts(8)<br/>Pat no: C020</p> |
|---|--|

- C: 10-24x1/2" bolts(4)  
Part no: C018

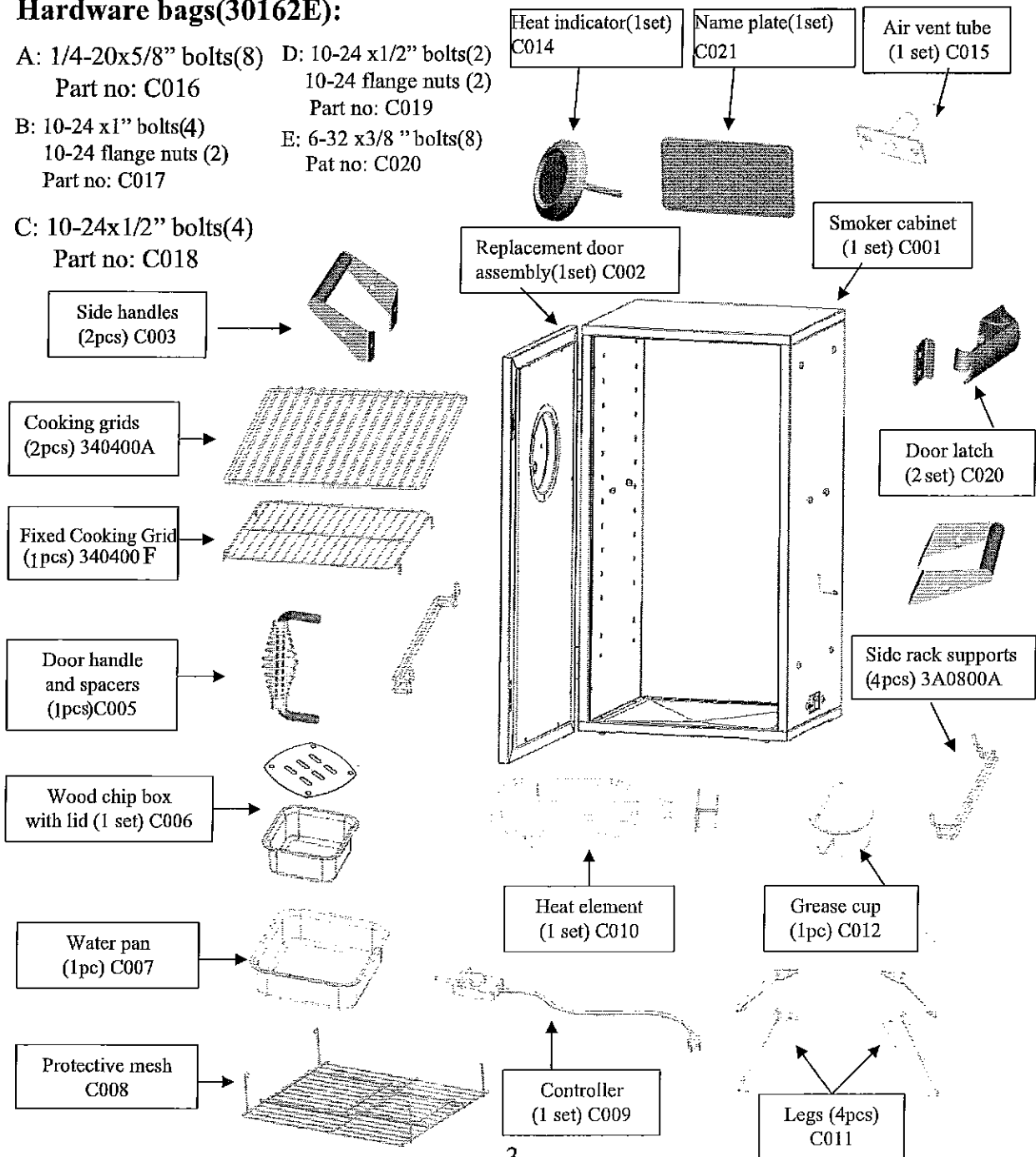

## Electric Smoker Assembly Instructions

### Assembly Step 2- Legs

Locate these parts: The legs (4pcs), Hardware bag A;  
Hardware bag A : 1/4-20x5/8" bolts(8pcs)  
Tools: Phillips head screwdriver

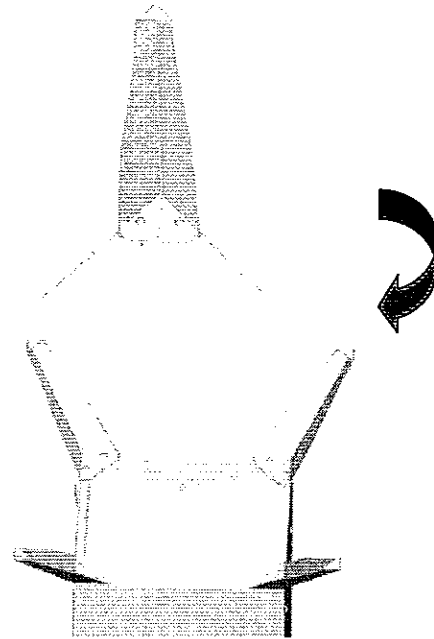
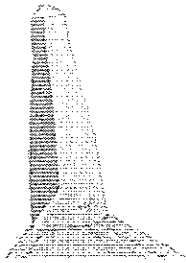

1. With the cabinet in the upright position, begin by removing the door panel from the cabinet assembly by lifting it from the hinges. Set the door panel aside, this will make assembly much easier.
2. For each leg, line up the holes and insert the bolts, nuts are pre-welded to the cabinet.
3. Securely tighten the bolts.
4. Turn over the cabinet.

### Assembly Step 3-Door Latch

Locate these parts: Door Latch(2 sets), Hardware bag E  
Hardware bag E : 6-32x3/8" bolt (8pcs)  
Tools: Phillips head screwdriver

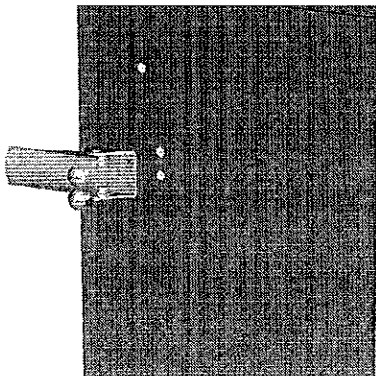

1. Attach the upper and lower door latches to the cabinet using (2) 6-32\*3/8 bolts for each latch, as shown in picture.

## Electric Smoker Assembly Instructions

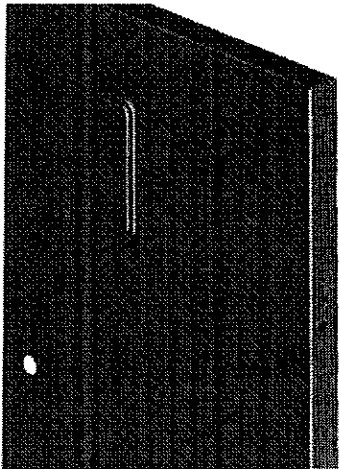

2. Attach the upper and lower door latch plates to the door using (2) 6-32\*3/8 bolts for each plate, as shown in picture.

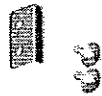

### Assembly Step 4- Air vent tube

Locate these parts: Air vent tube (1 set), Hardware bag B;

Hardware bag B : 10-24 x1" bolts(2pcs)/10-24 flange nuts(2pcs)

Tools: Phillips head screwdriver/ 3/8" wrench

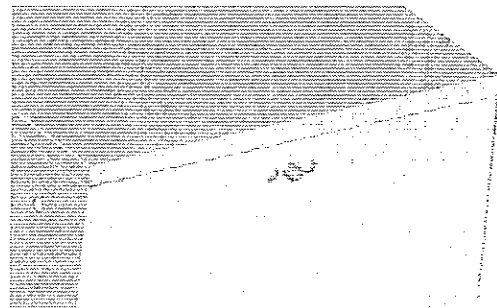

1. For air vent tube, line it up with back panel holes on the inside of smoker cabinet.

2. Insert two bolts from the outside of the cabinet.

3. From inside the cabinet, slide lock washers onto bolts and thread nuts onto bolts. Securely tighten nuts.

## Electric Smoker Assembly Instructions

### Assembly Step 5- Side handles

Locate these parts: Side handles (2pcs), Hardware bag C;  
Hardware bag C : 10-24x1/2" bolts/ (4pcs)  
Tools: Phillips head screwdriver/ 3/8" wrench

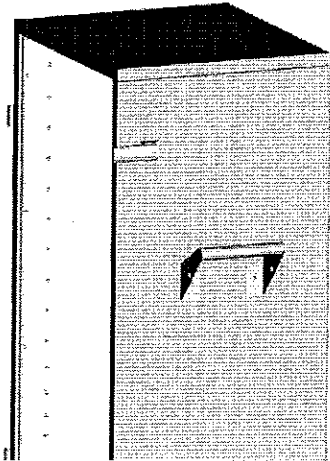

1. Line up the side handle with the corresponding holes on the side of the cabinet as shown. The handles must be positioned upright with the bolt holes on the side as shown.
2. Insert the bolts from the outside and the lock washers and nuts from the inside of cabinet.
3. Securely tighten.
4. Complete steps for both sides of the cabinet assembly.

### Assembly Step 6- Heat element

Locate these parts: Heat element (1 set), Hardware bag D;  
Hardware bag D : 10-24 x1/2" bolts(2pcs)/ 10-24 flange nuts (2pcs)  
Tools: Phillips head screwdriver/ 3/8" wrench

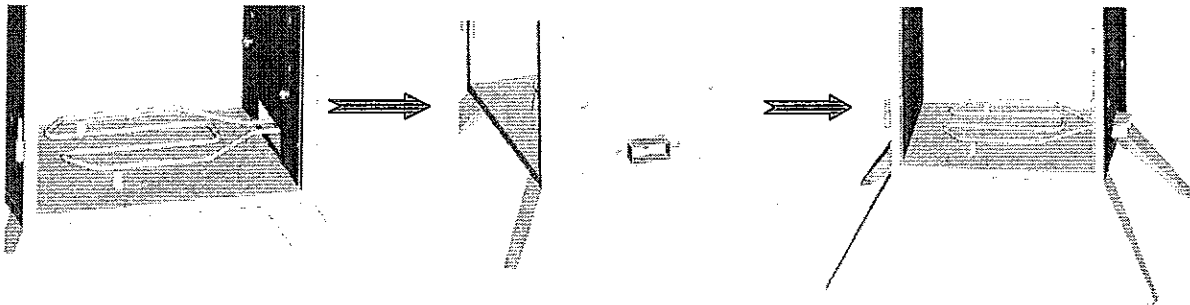

1. Position the heat element inside the cabinet and push the bracket through the opening in the right side panel.
2. Insert two bolts from the outside of cabinet.

3. Apply flange nuts and securely tighten.



## Electric Smoker Assembly Instructions

### Assembly Step 7- Side racks

Locate these parts : side racks (4 pcs)

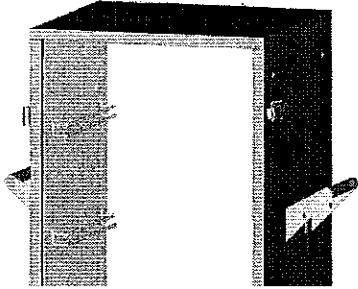

Insert the rack supports into the mounting holes inside the smoker cabinet as shown.

### Assembly Step 8- Water pan/Wood chip box/Protective mesh

Locate these parts: water pan(1pc)/wood chip box with lid(1set)/Protective mesh (1pc)

Tools: Phillips head screwdriver/ 3/8" wrench

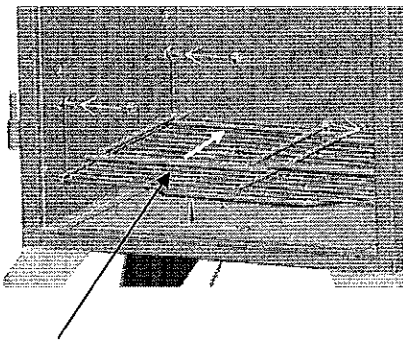

Protective mesh

1. Unscrew the bottom four bolts and put protective mesh into cabinet. Then mount the protective mesh into corresponding screws to tighten them.

2. Place water pan and wood chip box with lid on Protective mesh .

**Warning: The water and wood chip pan should be placed on the protective mesh only and not on the heating element.**

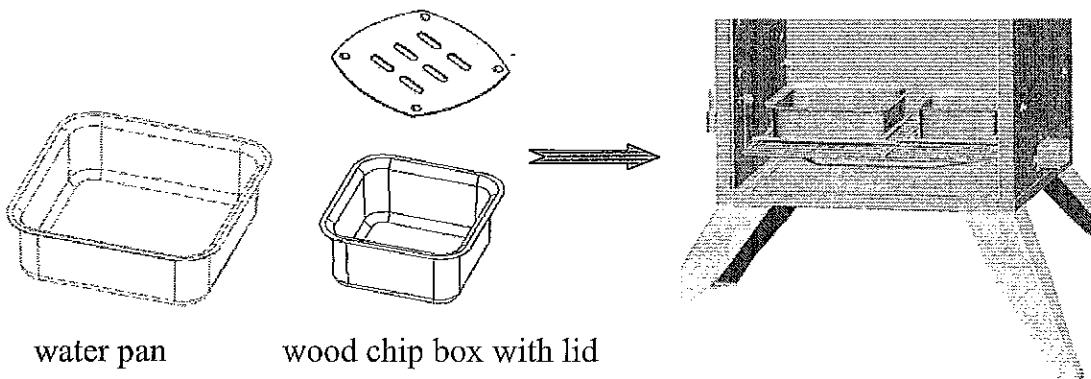

water pan

wood chip box with lid

## Electric Smoker Assembly Instructions

### Assembly Step 9- Cooking grids

Locate these parts :    cooking grids (2pcs)

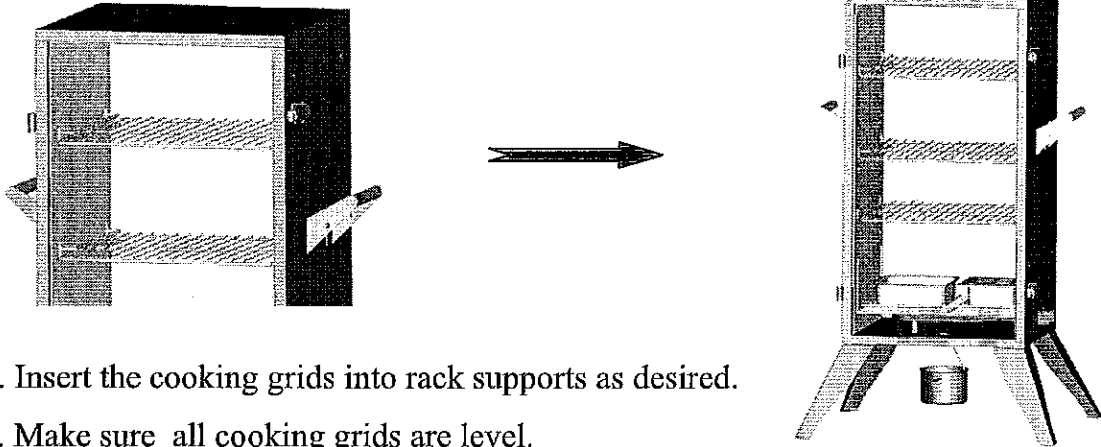

1. Insert the cooking grids into rack supports as desired.
2. Make sure all cooking grids are level.

### Assembly Step 10- Door handle

Locate these parts: Door handle (1set), Hardware bag B;

Tools:                    Phillips head screwdriver and Wrench

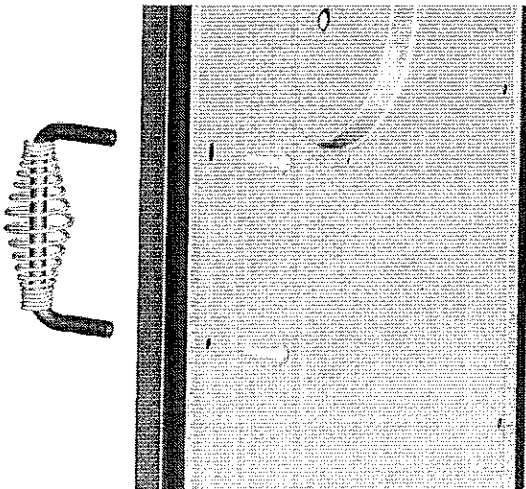

1. Attach the door handle to the door with (2pcs) 10-24 x1" bolts.

## Electric Smoker Assembly Instructions

### Assembly Step 11- Heat indicator

Locate these parts: Heat indicator (1 set)

Tools: Wrench

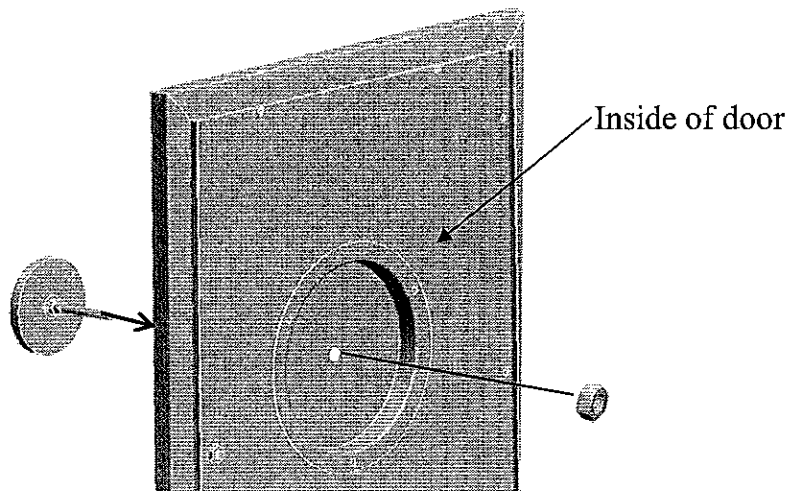

1. Insert heat indicator probe through the mounting hole in the front of the door.
2. From the inside of the door panel, place nut onto the mounting thread pole and tighten firmly.

### Assembly Step 12- Grease cup

Locate these parts : Grease cup (1set)

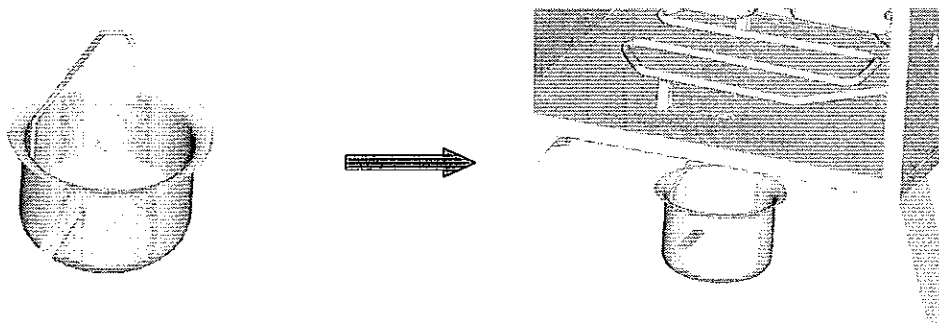

1. Hook grease cup to bottom panel as shown.

2. Make sure the connection is secure and the grease cup sits level.

## Electric Smoker Assembly Instructions

### Assembly Step 13- Controller

Locate these parts : Controller (1set)

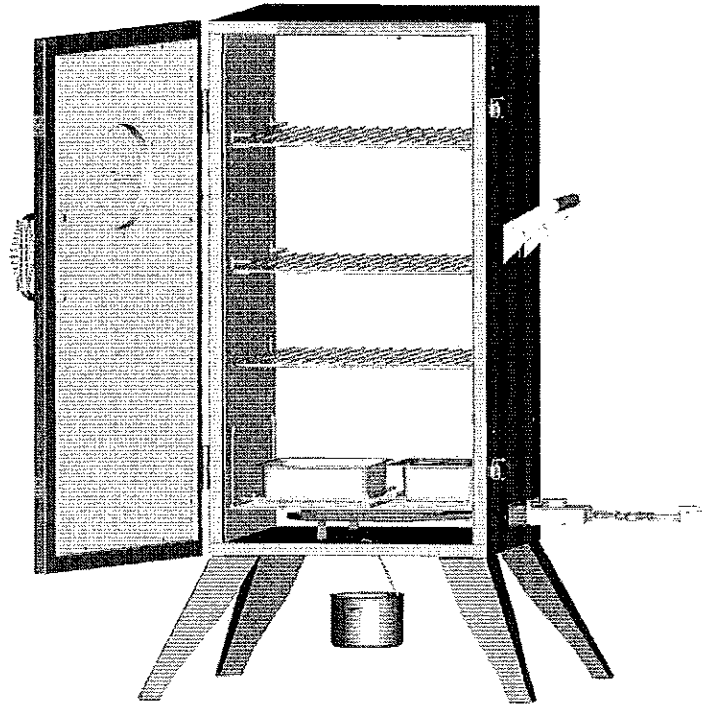

Locate the controller and insert the probe into the bracket of the heat element as shown. make sure the connection is secure and tight.

---

**Assembly is now complete!** Please follow all instructions and safeguards in this manual during operation and storage.

## Electric Smoker Operating Instructions

---

- ❖ **Smoker is intended for outdoor use only and should be used on a hard, level, non-combustible surface away from roof overhangs and/or any combustible material. Do not use smoker on wooden surface or any other surface that could burn. Place the smoker in an outdoor area that is protected from the wind and keep the smoker away from open windows or doors to prevent smoke from entering your home.**
- ❖ **Curing Your Smoker:**

Before first use, cure your smoker to minimize damage to the exterior finish as well as rid the smoker of paint odor that can impart unnatural flavors to the first meal prepared.

  1. Remove water pan from smoker and do not use flavoring wood while curing your smoker.
  2. Coat all interior surfaces of the smoker cabinet, side rack and cooking grill with vegetable oil or vegetable oil spray.  
Note: **DO NOT** coat the electric element and the controller.
  3. Plug the smoker into electric outlet.
- ❖ **Warning:** Always use a 3-wire grounded outlet wired for 120 volts which is GFCI protected at 15 or 20 amps. If in doubt, contact a qualified electrician. Do not operate any other appliances or electrical devices on the same circuit as the smoker.
- 4. Cure smoker for two hours, then unplug smoker from electric outlet. Allow smoker to cool completely. It is important that the exterior of the smoker is not scraped or rubbed during the curing and cooling process.
- ❖ Cure your smoker before first use. After cleaning, apply a light coat of vegetable oil or vegetable cooking spray to the interior surfaces, smoker body, cooking grids and water pan. This simple process will help reduce interior rusting. **DO NOT** apply oil to electric element or controller.
- ❖ **Read all safety warnings and instructions before operating your smoker.**
  1. Open door and remove wire rack that supports the wood chip pan and water pan.
  2. Remove lid from the wood chip pan and add wood chips. We recommend the use of wood chips, not wood chunks. Replace the wood chip pan lid and slide rack into smoker.
  3. Carefully fill water pan with warm water or your choice or marinade to ½ inch below the rim. Do not fill completely or water may overflow during use.
- ❖ **Warning:** Do not spill water, marinade or any liquid onto the electric element and controller.
- 4. Remove cooking grids and adjust the wire cooking grid support brackets to the desired height for the items you are smoking.

## Electric Smoker Operating Instructions

---

5. Place food on cooking grid(s) in a single layer and leave room between each piece to allow smoke and moisture to circulate evenly. Slide cooking grid into the wire cooking grid support brackets. Repeat steps for each cooking grid that is used.
6. Close door and plug the smoker into electric outlet.
- ❖ **Warning:** Always use a 3-wire grounded outlet wired for 120-volts that is GFCI protected at 15 or 20 amps. If you are not sure the outlet is suitable, contact a qualified electrician. Do not operate this smoker on the same circuit with any other appliance or electrical device.
- ❖ **Warning:** When connecting controller to smoker, plug electric controller into smoker first, make sure controller is set to OFF, then plug into outlet. When unplugging, turn controller to OFF, disconnect from outlet, then remove controller from smoker.
7. Adjust the electric controller to the high position and allow the smoker to heat up. The desired temperature for smoking is between 220F and 250F. The heat indicator on the front of the unit will let you know when the smoker is near the desired temperature and you can adjust the controller accordingly.
8. Allow food to cook approximately 30-45 minutes per pound. Check the water level periodically and add water if needed. When adding water, wear an oven mitt and slide the wood chip pan/water pan rack slightly toward the door opening, add water and slide the rack back into place. You can add additional wood chips by following the same procedure.
9. Use a meat thermometer to check the temperature of your food. The heat indicator on the door will provide the approximate temperature inside the smoker but you should use a meat thermometer to ensure that your food is fully cooked.
10. After you are finished smoking, turn the controller knob to the off position and always unplug the smoker from the electric outlet and allow the smoker to cool. Once the smoker has cooled, follow the instructions in the "Safety, Care and Maintenance" section of this manual.

**Notes: Performance of the smoker is dependent on ambient temperature and wind conditions.**

---

### ◆ Temperature chart

Here is a chart for measuring properly cooked meat temperature(USDA standard)

- |   |                      |                    |                      |
|---|----------------------|--------------------|----------------------|
| ◆Turkey-- 180 ° F                         | ◆Pork--160 ° F       | ◆Chicken-- 180 ° F | ◆Fresh Lamb--160 ° F |
| ◆Duck-- 180 ° F                           | ◆Fresh Veal--160 ° F | ◆Beef- 160 ° F     | ◆Fresh Ham-- 180 ° F |
| ◆Fish—Cook until opaque and flakes easily | ◆Shrimp- Until pink  |                    |                      |

Note: These temperatures are measured with a meat probe thermometer. The heat indicator on the door of the smoker is not an accurate meat temperature reading.

## Safety Care and Maintenance

### ❖ Safety Warning :

- Always allow the smoker and all components to completely cool before handling or cleaning.
- Before storing smoker or leaving unattended, remaining embers, hot coals, and ashes must be removed. Be careful to protect yourself and your property. Any remaining embers, hot ashes or hot coals should be placed in a non-combustible metal container and completely saturated with water. Leave ashes and water in the metal container for 24 hours before you dispose of them.
- Place extinguished embers, coals and ashes a safe distance from any combustible materials.
- Once smoker has cooled, remove electric cord and controller and store the unit indoors in a dry location. Electric cord and controller should also be stored in a dry location that is out of the reach of children.
- Do not operate smoker with an electric controller that has a damaged cord, plug or metal probe. The electric controller is made specifically for this smoker, call us for a replacement controller.
- Never immerse electric controller or heating element in any liquid.

### ❖ Care and Maintenance

- Water pan, wood chip pan and cooking grids should be washed with hot, soapy water then rinsed and allowed to dry. Cooking grids can be lightly coated with vegetable oil or cooking spray to prevent food from sticking.
- A light coating of vegetable or cooking spray may also be applied to the inside of the smoker to prevent rusting.
- If rust appears on the exterior of the smoker, clean the affected area with steel wool and apply a high-temperature resistant paint.
- Do not apply additional paint to the interior surface of the smoker. If rust develops, use steel wool to remove and then coat with vegetable oil or cooking spray.
- When cool and not in use, store your smoker indoors in a dry location to protect against rusting.
- After the electric element has completely cooled, clean with a damp cloth after each use.



Voltage:	120VAC	Amperage:	12.5A
Watts:	1500W	Hertz :	60 HZ

## Limited Warranty

This Smoke Hollow™ Smoker is guaranteed against broken or damaged parts at time of purchase. All parts carry a 1-year limited warranty with the exception of the water bowl, which is guaranteed to be free of defects for 90 days. Paint is guaranteed to be free of defects for 90 days except for rust, which may appear after repeated use.

This warranty does not cover damage or issues related to neglect, abuse or modifications to the product. Repair labor is not covered.

All parts that meet the warranty requirements will be shipped at no-charge via the discretion of the Customer Service Department (ground shipments, US Mail or Parcel Post ONLY). Any special handling charges (i.e. Second Day, Overnight, etc.) will be the responsibility of the consumer.

All warranty claims apply only to the original purchaser and require a proof of purchase verifying purchase date. Do not return parts to our address without first obtaining a return authorization number from our Customer Service Department.

This service is available by calling 866-475-5180, 8:30am to 4:30pm, Central Time, Monday through Friday, or by writing to Outdoor Leisure Products, Inc., 5400 Doniphan Drive, Neosho, MO 64850.

This warranty may give you specific legal rights that vary by state.

# SMOKE HOLLOW

## Outdoor Leisure Products

Outdoor Leisure Products Inc  
5400 Doniphan Drive  
Neosho, MO 64850  
Toll Free: 866-475-5180  
Website: [www.olp.inc.com](http://www.olp.inc.com)

---



# Smoke Hollow Wood Smokers

## Tips & Recipes

### Getting Started

Before you start smoking make sure you have the proper utensils necessary. First you will need two thermometers. One for checking the inside temperature of your smoker and the other for checking the internal temperature of your meat. The outside temperature gauge will give you an indication of the temperature inside your smoker, but it is always best to check to ensure the proper cooking temperature. The meat thermometer will be used for checking the internal temperature of the meat for preferred doneness.

Good tongs or a meat hook will also be needed when you are smoking. Tongs can be used on your smaller cuts of meat or if you choose to smoke vegetables. If you prefer not to hang your sausage while smoking them the tongs can be used then too. A meat hook is suggested when smoking larger cuts of meat. Also when using a meat with a rub or sauce the meat hook will allow you to handle the meat without knocking off any seasonings.

Always use heavy-duty oven mitts when moving the hot smoker racks or large pieces of meat. When adding extra water or wood chips to your smoker the oven mitts will help prevent injury caused by extreme heat.

Use aluminum foil to wrap when meat has reached desired color and temperature. The foil will protect your meat from the wood resins darkening your meat any further.

### Seasoning Your Smoke Hollow Smoker

First, before cooking with your Smoke Hollow Smoker make sure you have seasoned it properly. You can use any cooking oil to season your smoker, peanut or vegetable oils work just fine. After applying the oil to the inside of the smoker, making sure the entire inside is covered, turn your smoker on the high setting and let the smoker burn for two hours, this allows the heat to burn off any dust or residue left during the manufacturing process. Also the oil will seep into the imperfections in the metal and create a water-proof surface to help prevent rusting.

### Popular Woods for Smoking Meats

The selection of wood being used to cook your meat is based mostly on personal preference. Location on the other hand also plays a role for what is popular. The flavor of each wood greatly differs from one to the other based on which meat you are cooking. We have listed some of the most popular woods below.

**Alder.** This Pacific Northwest wood offers a truly unique sweet flavor. Used mostly for cooking salmon and other fish. Also tastes great with any seafood and vegetables.

**Apple.** A popular Northeast flavor, just like the apple itself, this wood produces a sweet fruity aroma when used. Apple wood will flavor any ribs, ham or poultry dishes very nicely.

**Cherry.** Like any fruit wood used for smoking the cherry wood will offer a sweet fruity flavor. It is not a strong smoke flavor so its often mixed with other more smoky flavored woods. Also, like apple wood, the cherry wood is great with any ham or poultry.

**Hickory.** An old time favorite and seems to be the most used wood for smoking. It adds a very heavy smoke flavor to your meats. Hickory is a wood that can be used for mixing with other woods, about half and half. Another reason hickory is very popular is because it's so easily found. Hickory provides great smoke flavor for ribs, ham and most all red meats.

**Pecan.** Just like the other fruit woods the pecan wood gives a sweet flavor to your meats. Pecan is used mostly for fish, poultry and vegetables. Because it burns cooler this wood works great when smoking larger cuts of meat.

**Maple.** This is the wood for cooking your hams and poultry. Maple will give you a sweet and not too strong flavor.

**Mesquite.** Mesquite is the southwest favorite. It gives a very strong flavor and can be over used very easily. Mesquite is not recommended when cooking large cuts of meat unless mixed with another wood. Works great with a smaller portion that takes less time to smoke.

**Oak.** Naturally a very heavy smoke flavor. Should be used by mixing with another wood, a fruit wood would be suggested. Smokes well with any meat just be careful not to overuse.

### Using your Smoke Hollow Smoker

#### Electric Smoker

Our Smoke Hollow Electric Smoker is most popular for its convenience. The short preparation time and its ability to sustain a constant temperature throughout the smoking process has made this one of our top selling models. Once setting the temperature of the smoker you will not have to stand and continually monitor the smoker. Just check temperature gauges as meat continues to warm up to make sure the internal temperature sustains your desired cooking temperature.

After the smoker has been properly seasoned it is ready to be used. The electric smoker will offer you a temperature range from 150 degrees to about 250 degrees while cooking. When using our electric smoker it is not necessary to soak your wood chips before cooking. Before cooking always preheat your smoker to to desired internal temperature. Always double check your internal temperature with another thermometer. While preheating smoker add water and called on amount of woodchips.

The suggested cooking range for our electric smoker is 220 degrees to 240 degrees. These temperatures will allow a slow cook for your meats while also offering the intended smoke flavor. If cooking small, thinner cuts of meat, the temperature may need to be

lowered to allow a longer cook time. Jerky for example is cooked around 190 degrees until desired dryness is reached. A good simple rule for smoking is to allow yourself 30 minutes per pound of meat. When desired internal temperature of meat is met wrap in foil to secure moisture inside and to protect from further browning.

After cooking and smoker has cooled a simple cleanup should be done. This is easy, just use a damp cloth or paper towel and wipe down cooking grids, water bowl, and wood chip pan. Never use any cleaning products on your smoker. The cleaners will strip the smoker of its seasoning and will create an acrid aroma while smoker is in use. For easier clean-up fit a piece of aluminum foil underneath the heating element to catch the grease drippings from your meat.

## Using your Smoke Hollow Smoker

### Gas Smoker.

Our gas smoker is operated basically the same way except for the fuel used for burning. One difference between the smokers is that our gas smoker will cook hotter and faster if not properly watched. The range of cooking temperatures in our gas models is about 225 degrees and can reach as high as 350 degrees. This is important to know when preheating and cooking with these models.

Start again by adding wood chips and water to your smoker. Since the gas burns hotter adding water to water bowl maybe necessary during the cooking process. This will keep your meat moist and flavorful. Before adding any meat to your smoker allow the smoker to produce full smoke and proper cooking temperature. And always check the internal temperature of smoker with a different thermometer to assure that front heat indicator is correct.

During cooking check the internal temperature of smoker. If temperature does change proper adjustments should be made. Cooking time has many factors: the size of the meat and the shape of the meat, type of meat, the distance of the meat from the source, temperature you are cooking at, and the outside temperature. Smoking meat is a slow process so take your time. All these factors make it very important to use both thermometers to ensure your proper temperature of meat. After desired internal temperature is met wrap meat in foil to protect from any further browning.

Clean-up for our gas smoker is simple. After smoker is cooled remove the cooking grids and wipe off with damp cloth or paper towel. The same goes for the inside of the smoker. Do not use cleaning supplies on the inside of smoker. This will strip away the seasoning of the smoker and could cause acrid fumes during future use, ruining the flavor of the meat.

## Temperatures of Meats

The USDA suggests the following internal temperatures of meats for safe eating.

- \* Beef, veal, lamb steak, roast and chops may be cooked to 145 degrees.
- \* All cuts of pork are to be cooked to 160 degrees.
- \* Ground beef, ground lamb, and ground veal are all to be cooked to 160 degrees.
- \* All poultry should reach a safe internal temperature of 165 degrees.

## Tips for Different Meats and Cuts

### Smoked Pork

Always wash meat thoroughly in cold water, dry to remove excess water, then add your favorite seasoning. Preheat smoker to 225 degrees and place loin in center of smoker. Cook until meat has reached 165 degrees internal temperature. Remove from smoker and wrap in heavy duty foil. Let meat stand until internal temperature has reached 170 degrees, then uncover and let cool. Slice it 1/4 inch thick or shave it, either way it will melt in your mouth.

**Brine.** A brine is a marinade for smoked meats. The easiest of brines to make for pork is as follows:

- 8 cups boiling water
- 2/3 cup kosher salt
- 1/2 cup packed brown sugar

Stir together ingredients. Let cool to room temperature. In medium sized bowl place pork and pour brine over the meat. Use two heavy plates to keep the pork below in the brine. Refrigerate and let set for 12 hours. Then pour off brine and rinse pork, patting dry also. Bring pork to room temperature. You are ready to smoke your pork.

### Smoked Pork Ribs

Wash the ribs in cold water and place on cutting board. Cut away any excess fat or skin from the bottom of the ribs. Turn ribs bone side up and peel the membrane from the back of the bone until fully removed. Use favorite pork rub seasoning on both sides of the ribs. Preheat smoker to 225 degrees and place into smoker rib bone side down. After one hour turn the rib bone side up and let cook for another hour. Now if you want to add BBQ sauce, remove ribs from smoker and pour a one inch strip down the center and wrap in foil. Place back into smoker for 1/2 hour. Start checking ribs every 15 minutes. When the rib meat easily separates when pulling with your fingers your ribs are done. Now remove from smoker and place on platter to cool.

A simple dry rub for ribs is as follows:

- 1/2 cup fresh ground pepper
- 1/2 cup ground cayenne pepper
- 1 cup dark brown sugar
- 3 tablespoons salt

Mix together in bowl. Rub on both sides of ribs before smoking.

**Smoked Beef Brisket**

Select a 8 - 6 lbs brisket, one with a little marble to it. Feel free to trim as much fat as desired. Use your favorite beef rub or seasoning and rub it on liberally. Preheat smoker to 225 degrees and place brisket in smoker for three hours. Then place brisket in an aluminum pan and pour 8 oz of Allegro over the brisket. Cover the pan and brisket with foil, place back into the smoker until internal temperature of the meat reaches 170 degrees. Remove pan and brisket from smoker and let stand. Remove the brisket from pan and cut into 1/4 inch slices, cutting against the grain. Use juice from pan to pour over sliced meat or for dipping.

**Prime Rib**

Select a bone on prime rib, 6 - 8 lbs. Rub with your favorite beef seasoning. Preheat smoker to 225 degrees and place prime rib in the center of the smoker. After 3 hours place the prime rib in aluminum foil pan and covering it with foil. Place covered brisket back into smoker. Watching it closely, remove the meat when internal temperature reaches 145 degrees. After removing the brisket let it stand still covered. The internal temperature will still rise up to 10 degrees while standing. Medium rare temperature is 155 - 160 degrees. Slice to desired thickness and use juice from pan for an au jus dipping sauce.

**Fish**

Select a nice 3/4 inch thick fillet. Wash fillet thoroughly in cold water and lay on a paper towel until water is not visible. Melt a stick of butter in the microwave. Sprinkle liberal amount of dill weed in the butter. Lay fillets on aluminum foil and fold a lip a around the edges to contain the butter. With a basting brush, brush the butter and dill weed mixture onto both sides of the fish. Preheat smoker to 225 degrees. Place

fish in the smoker. Check the fillets every 15 minutes for visible moist look. Brush with butter and dill weed when needed. Fish should start to flack after about 45 minutes. When fish start to flake, carefully remove from smoker and serve.

**Smoked Chicken**

Remove chicken parts from package, wash thoroughly and place on paper towel to dry. Sprinkle favorite rub on both sides of all chicken parts. Preheat smoker to 225 degrees. Place chicken in smoker. After 30 minutes turn chicken over. With internal temperature gauge check chicken temperature. Always check the meat nearest the bone. When temperature of the chicken reaches 180 degrees it is done. During the last 15 minutes of cooking you can brush your favorite BBQ sauce for additional flavor.

**Smoked Turkey**

Select a 12 - 15 pound turkey. Remove turkey from package. Remove the insides of the turkey. Wash turkey thoroughly and place on paper towel to dry. Rub olive oil inside and outside of the turkey. Place your favorite rub or seasoning on the skin of the turkey and inside the cavity. Preheat smoker to 225 degrees. Place turkey in smoker. You may want to baste turkey with butter for added moisture. When turkey reaches color, remove from smoker and place in foil pan. Cover the pan and turkey with foil and place back in smoker. Continue cooking at 225 degrees. Check internal meat temperature where the thigh meets the side of the turkey. Check temperature every 30 minutes for doneness. Turkey should take about 45 minutes per pound to cook. Serving temperature for the turkey is 180 degrees. When internal temperature reaches 180 degrees the bird is done and ready to serve.