

# MONTE CARLO

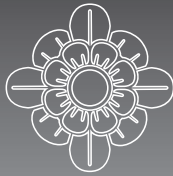

CEILING FAN COMPANY

## Owner's Guide and Installation Manual

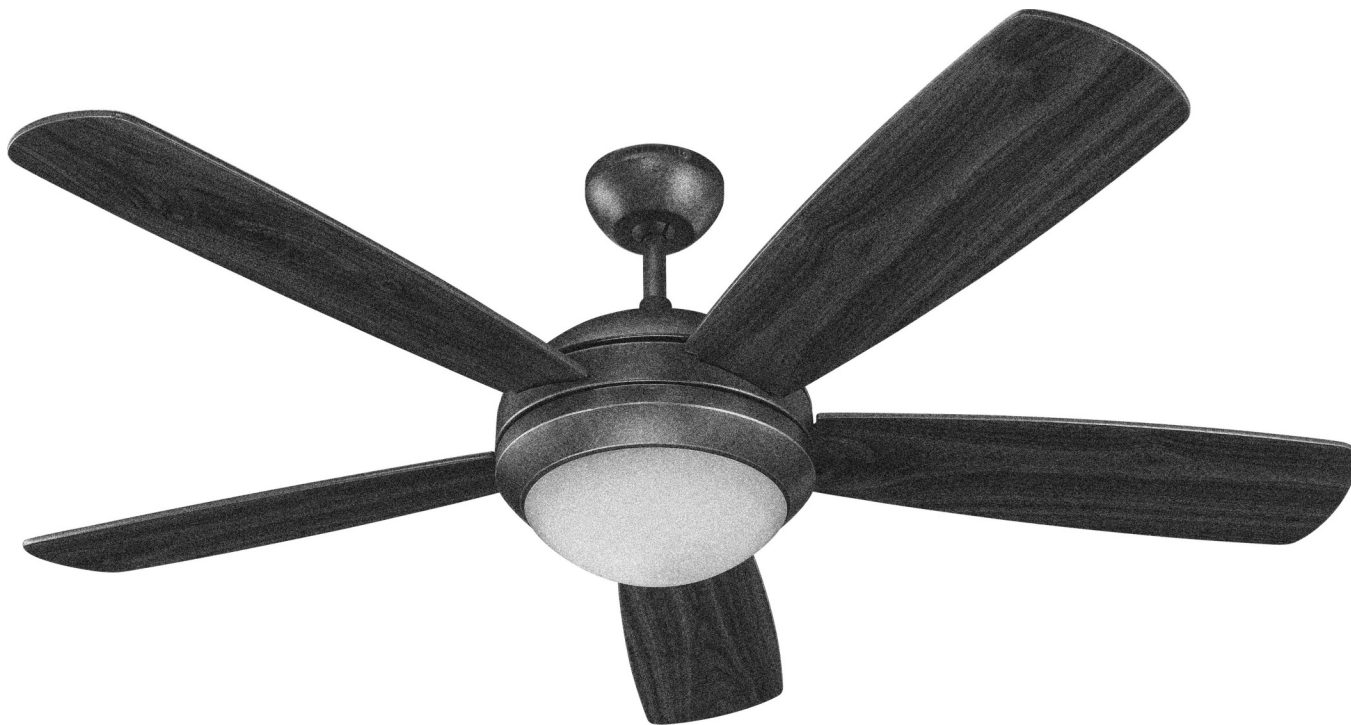

### 5DI52XXD/5DI52XXD-L Series Fan

UL Model No. : 5DI52

Attach sales receipt to this card and retain as your proof of purchase

DATE OF PURCHASE: \_\_\_\_\_

RETAILER NAME: \_\_\_\_\_

MODEL NUMBER: \_\_\_\_\_

RETAILER ADDRESS: \_\_\_\_\_

To register your fixture, please visit our website [www.montecarlofans.com](http://www.montecarlofans.com)



8.5 kgs  
18.7 lbs

Total fan weight with light



## Cautions and Warnings

**WARNING: TO REDUCE THE RISK OF FIRE, ELECTRIC SHOCK, OR INJURY TO PERSONS, OBSERVE THE FOLLOWING: READ AND SAVE THESE INSTRUCTIONS**

Installation work and electrical wiring must be done by qualified person(s) in accordance with applicable codes and standards (ANSI/NFPA 70-1999), including fire-rated construction.

Use this unit only in the manner intended by the manufacturer. If you have any questions contact the manufacturer.

After making the wire connections, the wires should be spread apart with the grounded conductor and the equipment-grounding conductor on one side of the outlet box and ungrounded conductor on the other side of the outlet box. The splices, after being made, should be turned upward and pushed carefully up into the outlet box.

**WARNING:** Before you begin installing the fan, servicing or cleaning unit, Switch power off at Service panel and lock service disconnecting means to prevent power from being switched on accidentally. When the service disconnecting means cannot be locked, securely fasten a prominent warning device, such as a tag, to the service panel.

Be cautious! Read all instructions and safety information before installing your new fan. Review the accompanying assembly diagrams.

When cutting or drilling into wall or ceiling, do not damage electrical wiring and other hidden utilities.

Make sure the installation site you choose allows the fan blades to rotate without any obstructions. Allow a minimum clearance of 7 feet from the floor to the trailing edge of the blade.

**WARNING:** To Reduce The Risk Of Fire, Electric Shock, or Personal Injury, Mount To Outlet Box Marked "Acceptable for Fan Support of 15.9 kg (35 lbs) or less" And Use Mounting Screws Provided With The Outlet Box.

**CAUTION:** For Compliance with Local Codes and Regulations, If Installing The Secondary Support Safety Cable in the U.S., Do Not Remove Knockouts In The Outlet Box. Mount the secondary support safety cable through the reserved nail/screw hole on the outlet box to the building structure (or the ceiling joist).

**WARNING:** To reduce the risk of personal injury, do not bend blade holders during installation to motor, balancing or during cleaning. Do not insert foreign object between rotating blades.

Attach the mounting bracket using only the hardware supplied with the outlet box.

**WARNING:** To reduce the risk of fire or electric shock, this fan must be installed with an isolating wall control/switch.

**WARNING:** To reduce the risk of fire or electric shock, do not use this fan with any solid state fan speed control device, or variable speed control.

If this unit is to be installed over a tub or shower, it must be marked as appropriate for the application.

Never place a switch where it can be reached from a tub or shower.

The combustion airflow needed for safe operation of fuel-burning equipment may be affected by this unit's operation. Follow the heating equipment manufacturer's guideline safety standards such as those published by the National Fire Protection Association (NFPA), and the American Society for Heating, Refrigeration and Air Conditioning Engineers (ASHRAE) and the local code authorities.

**CAUTION:** To Reduce the Risk of Electric Shock, Disconnect the electrical supply circuit to the fan before installing the light kit.

All set screws must be checked and tightened where necessary before installation.

Tools Required for Assembly (not included): Electrical Tape, Phillips Screwdriver, Pliers, Safety Glasses, Stepladder and Wire Strippers.

Customer Service  
800-969-3347

Customer Service Center  
7400 Linder Ave.  
Skokie, IL 60077  
[www.montecarlofans.com](http://www.montecarlofans.com)

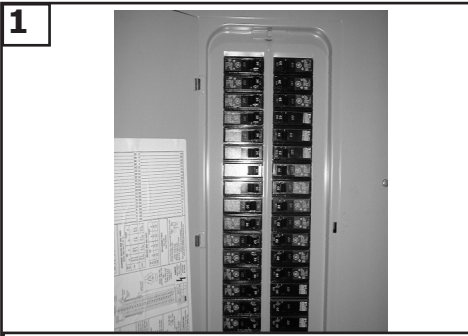

**1** Before you begin installing the fan, Switch power off at Service panel and lock service disconnecting means to prevent power from being switched on accidentally. When the service disconnecting means cannot be locked, securely fasten a prominent warning device, such as a tag, to the service panel.

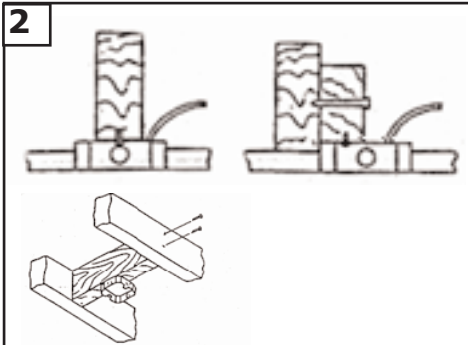

**2** Before installing this fan make sure the outlet box is properly installed to the house structure. To reduce the risk of fire, electric shock, or personal injury, mount to outlet box or supporting system acceptable for fan support. (Mounting must support at least 35 lbs.)

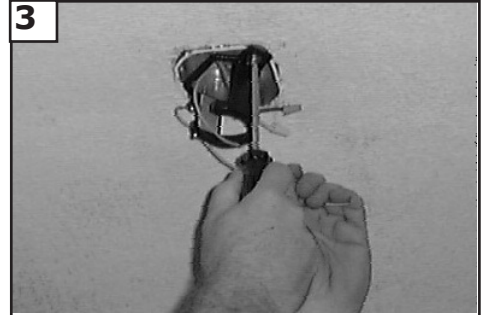

**3** Use metal outlet box suitable for fan support (must support 35 lbs). Before attaching fan to outlet box, ensure the outlet box is securely fastened by at least two points to a structural ceiling member ( a loose box will cause the fan to wobble). **Use only the screws provided with the outlet box.**

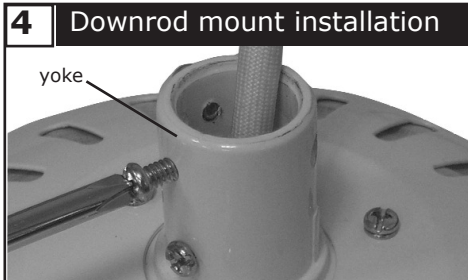

Loosen the 2 set screws till you can not feel them on inside of yoke.  
**Note:** If install fan on vaulted ceiling, make sure open end of mounting bracket is installed facing the higher point of the ceiling and make sure the ceiling angle is not steeper than 30°.

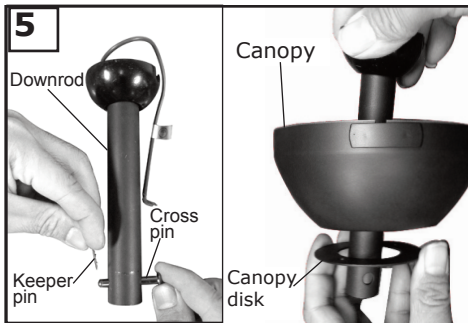

**5** Remove Keeper pin and cross pin from downrod. Place canopy and canopy disk cover over downrod.

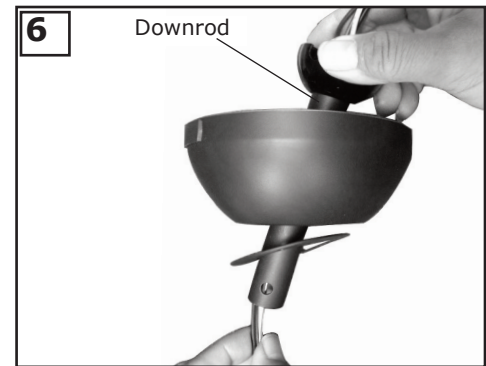

**6** Thread leadwires and safety cable through downrod.



**7** Place downrod into fan yoke.

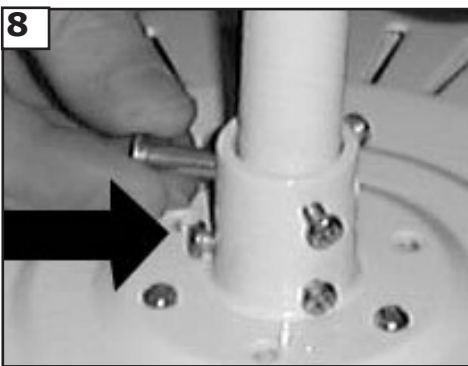

**8** Align the hole in the Downrod with the hole in the Yoke. Insert the Pin through the Yoke and Downrod until the point appears on the other side.

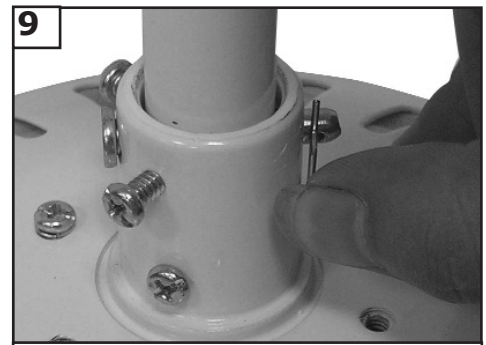

**9** Install the keeper to pin.

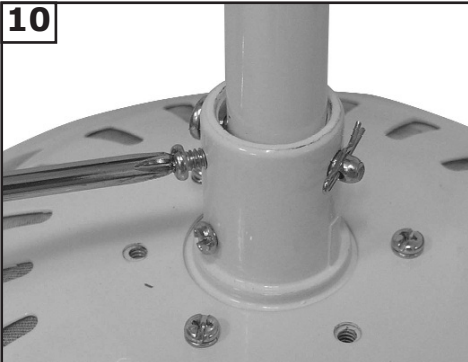

**10**  
Tighten the 2 set screws on the yoke once the downrod is in place.

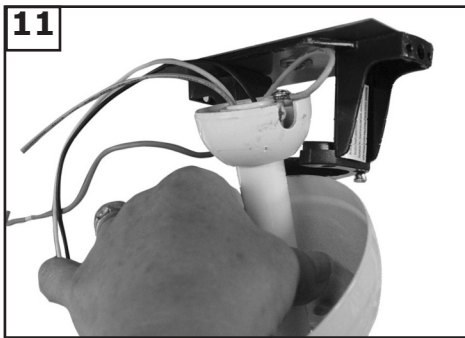

**11**  
Hang assembled fan from the mounting bracket installed to ceiling in previous step. Make sure the fan is hanging straight. Rotate fan until the tab on the Mounting bracket engages the slot on the Downrod Ball. This must be done to prevent the fan body from rotating when the blades are in motion.

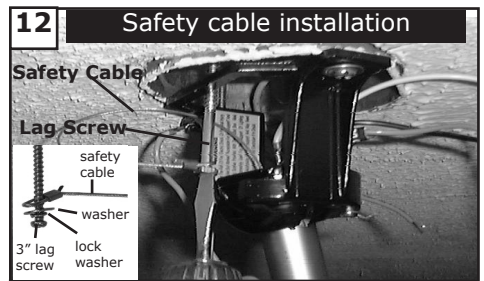

**12** Safety cable installation  
For Canadian installation and for USA fan and light kit combinations over 35 lbs, in both flush and downrod modes the safety cable must be installed into the house structure beams using 3" lag screws, washers and lock washers provided. Make sure that when the safety cable is fully extended the lead wires are longer than the cable and no stress is placed on the lead wires.  
**Note:** If Installing The Secondary Support Safety Cable in the U.S., Do Not Remove Knockouts In The Outlet Box.

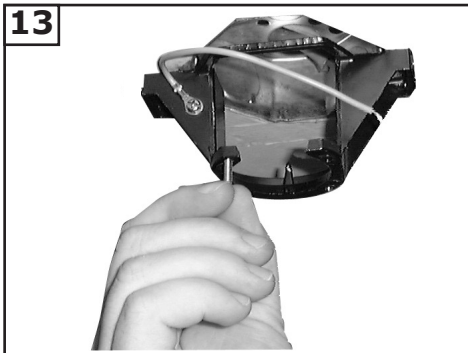

**13**  
Make sure the studs protruding from the bottom of the Mounting bracket are installed with threads all the way through the bracket.

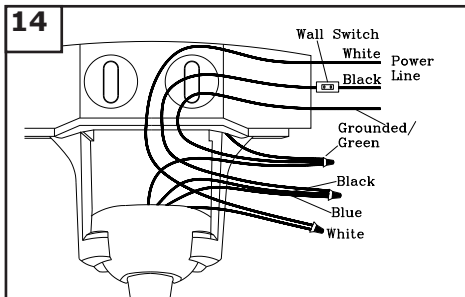

**14**  
Make wiring connections as indicated above. Connect black and blue wire from fan to Black or (Hot) wire from house. Connect White wire from Fan to White (Neutral) wire from house. Connect Ground leads from mounting bracket and downrod to Ground lead from house. Refer to Safety Tips section of manual.

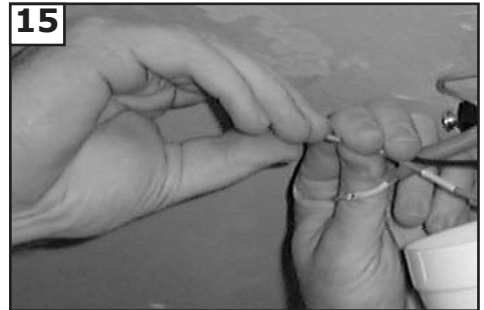

**15**  
Make wire connections to power source using wire nuts provided. Make sure that no filaments are outside of the wirenut. After making the wire connections, the wires should be spread apart with the grounded conductor and the equipment-grounding conductor on one side of the outlet box and ungrounded conductor on the other side of the outlet box.

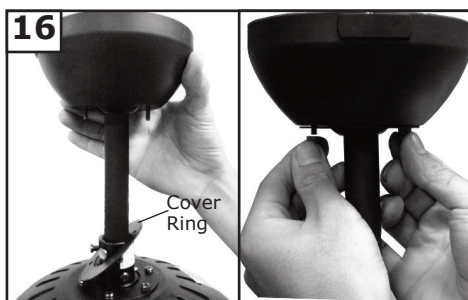

**16**  
Lift Conopy allowing the 2 studs to protrude through the canopy. Next lift the cover ring and install knurled nuts as shown. Tighten the knurled nuts securely. The canopy should adjust for any irregularity in the ceiling or Outlet box.

Go to step 26

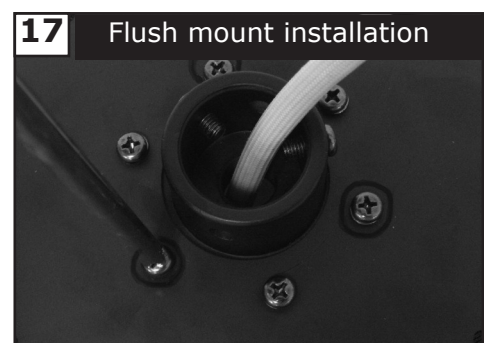

**17** Flush mount installation  
Remove every other screw as circled and save for later use.  
**Note:** Flushmount is not available with vaulted ceiling.

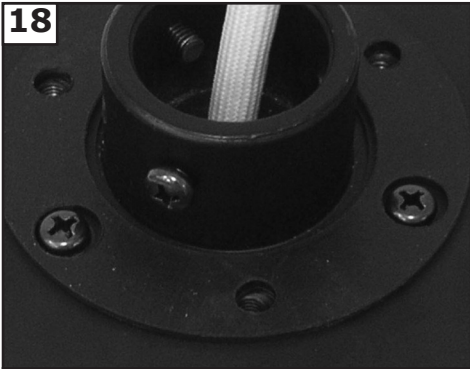

**18**  
Install rubber pad between fan body and canopy.

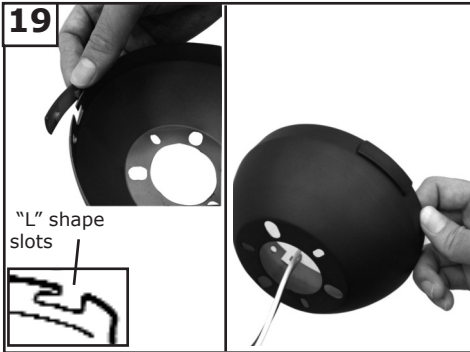

**19**  
Remove side covers from canopy exposing 4 holes. 2 closed holes and 2 open "L" shape holes and then Pass leadwires and safety cable through the canopy.

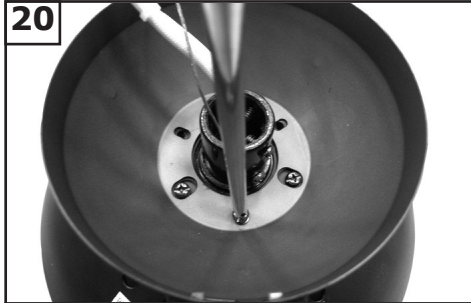

**20**  
Place canopy over fan body aligning holes. Replace the 3 screws removed and tighten securely. Check motor for shipping stabilizers and remove if present.

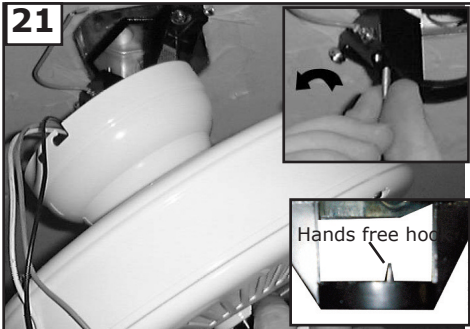

**21**  
Remove the all thread studs from the lower part of the mounting bracket. Hang fan from mounting bracket by the hands free hook into a closed hole on the edge of the Canopy. **Note:** For Canadian mounting refer to Step #12.



**22**  
Take 4 screws from hardware pack and install one on each side of bracket to match the L slot screw holes in canopy. Keep 2 screws for later use.

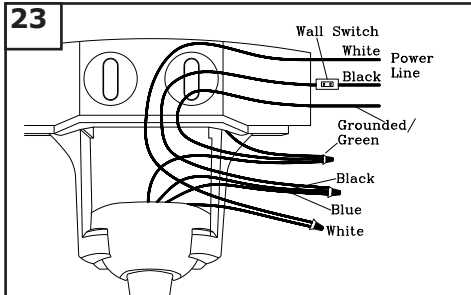

**23**  
Make wiring connections as indicated above. Connect black and blue wire from fan to Black or (Hot) wire from house. Connect White wire from Fan to White (Neutral) wire from house. Connect Ground leads from mounting bracket and downrod to Ground lead from house. Refer to Safety Tips section of manual.

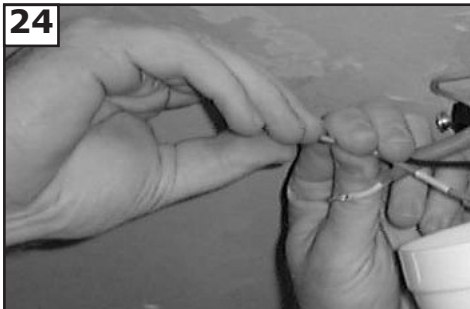

**24**  
Make wire connections to power source using wire nuts provided. Make sure that no filaments are outside of the wirenut. After making the wire connections, the wires should be spread apart with the grounded conductor and the equipment-grounding conductor on one side of the outlet box and ungrounded conductor on the other side of the outlet box.



**25**  
Lift fan to mounting bracket, aligning the "L" shape holes with the screws on the mounting bracket. Turn the fan clockwise to lock in position. Install the other 2 screws included in hardware bag and tighten all 4 securely.

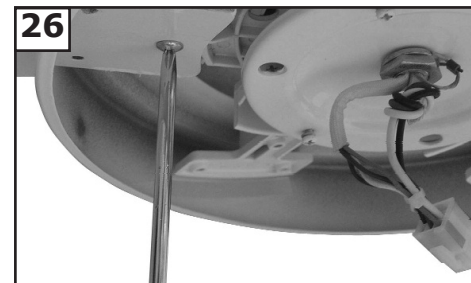

**26**  
Check the motor for shipping stabilizers and remove if present. Attach blades using screws and washers in hardware pack. Tighten screws securely. **Note:** Tighten set screws twice a year.

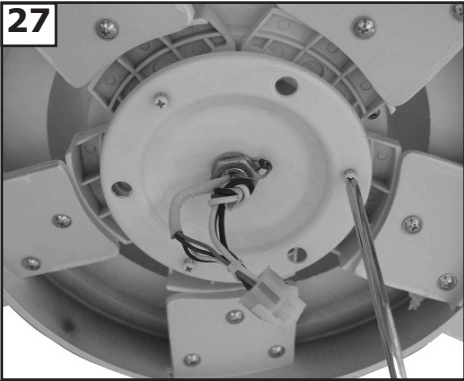

**27**  
Loosen 2 screws and remove 1 screw from motor plate. Save removed screw for use later.

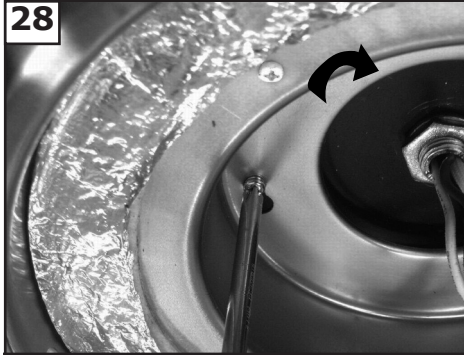

**28**  
Install by twisting clockwise, add 1 screw removed step 27 to switch housing plate. Tighten the 3 screws securely.

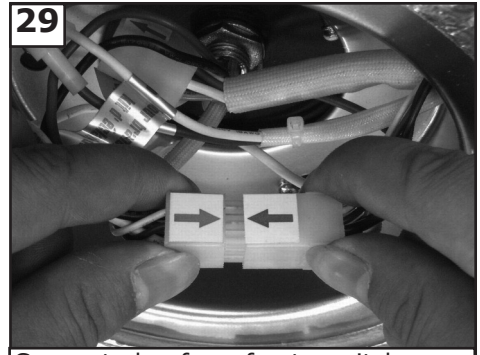

**29**  
Connect plug from fan to switch house plug. Be sure plugs connection snap together completely.

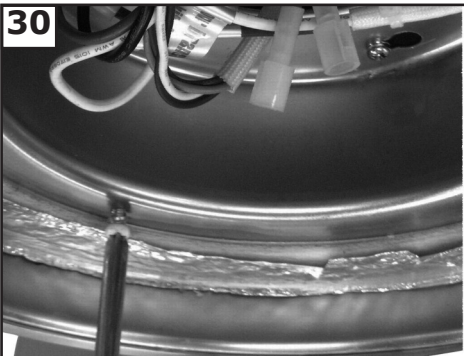

**30**  
Loosen the pre installed screws of switch housing plate. Save removed screw for use later.

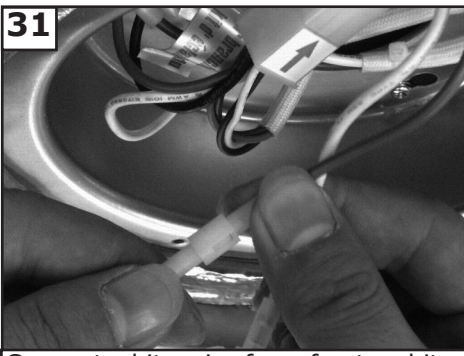

**31**  
Connect white wire from fan to white wire from light fixture. Then plug blue wire from fan to black wire from light fixture.

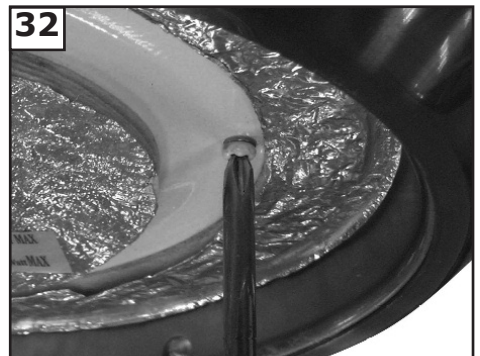

**32**  
Install 3 screws to install light pan.



**33**  
Install a JD 75 watt halogen bulb, bulb included.  
**Caution:** Do not replace bulb until it cools down.  
**WARNING:** Over lamping the fan will result in the fan lights shutting down until the proper wattage of bulbs are installed. Reset the lights by turning off the wall switch, breaker, or by remote. Replace bulbs with the correct wattage bulbs, turn the power on.

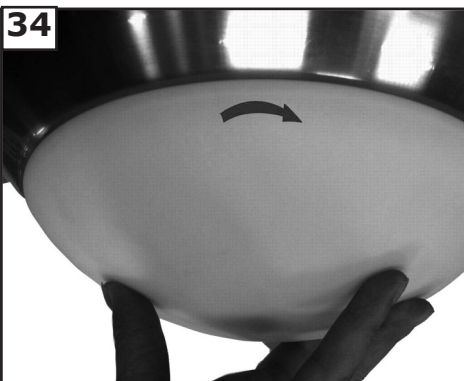

**34**  
Attach glass by locating dimples in light fixture with the grooves in glass and twisting clockwise till tight.

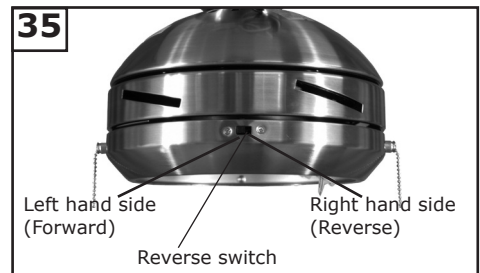

**35**  
Setting the reverse switch in the left hand side will result in downward airflow and setting the switch in the right hand side will result in upward airflow.  
**Note:** Reverse switch must be set either completely LEFT or completely Right for fan to function. If the reverse switch is set in the middle position, fan will not operate.



## TROUBLE SHOOTING

If you have difficulty operating your new ceiling fan, it may be the result of incorrect assembly, installation, or wiring. In some cases, these installation errors may be mistaken for defects. If you experience any faults, please check this Trouble Shooting Chart. If a problem cannot be remedied, or you are experiencing difficulty in installation, please call our Customer Service Center at the number printed on your parts list insert sheet.

**Warning: Before servicing or cleaning unit, Switch power off at Service panel and lock service disconnecting means to prevent power from being switched on accidentally. When the service disconnecting means cannot be locked, securely fasten a prominent warning device, such as a tag, to the service panel.**

Trouble	Suggested Remedy
1. If fan does not start:	<ol style="list-style-type: none"><li>1. Check main and branch circuit fuses or circuit breakers.</li><li>2. Check line wire connections to fan and switch wire connections in switch housing.</li></ol> <p><b>CAUTION: Make sure main power is turned off.</b></p> <ol style="list-style-type: none"><li>3. Make sure forward/reverse switch is firmly in up or down position. Fan will not operate when switch is in the middle.</li><li>4. Make sure that shipping stabilizer tabs have been removed from motor.</li></ol>
2. If fan sounds noisy:	<ol style="list-style-type: none"><li>1. Check to make sure all screws in motor housing are snug (not over tightened).</li><li>2. Check to make sure the screws which attach the fan blade holder to the motor are tight.</li><li>3. Check to make sure wire nut connectors in switch housing are not rattling against each other or against the interior wall of the switch housing.</li></ol> <p><b>CAUTION: Make sure main power is turned off before entering switch housing.</b></p> <ol style="list-style-type: none"><li>4. If using an optional Ceiling Fan Light Kit, check to be sure the screws securing the glass-ware are finger tight. Check to be sure light bulb is tight in socket and not touching glass shade(s). If vibration persists from glass, remove glass and install a 1/4" wide rubber band on glass neck to act as an insulator. Replace glass and tighten screws against rubber band.</li><li>5. Some fan motors are sensitive to signals from Solid State variable speed controls. <b>DO NOT USE a Solid State variable speed control.</b></li><li>6. Allow "break-in" period of 24 hours. Most noises associated with a new fan will disappear after this period.</li></ol>
3. If fan wobbles:	<ol style="list-style-type: none"><li>1. If this is a downrod mount fan, make sure the ridge on mounting bracket engages the notch in the downrod ball.</li><li>2. Check that all blades are screwed firmly into blade holders.</li><li>3. Check that all blade holders are tightened securely to motor.</li><li>4. Make sure that canopy and mounting bracket are tightened securely to ceiling junction box and junction box is mounted firmly to ceiling joist.</li><li>5. Most fan wobble problems are caused when blade levels are unequal. Check this level by selecting a point on the ceiling above the tip of one of the blades. Measure this distance from blade tip to ceiling. Keeping measure within 1/8", rotate the fan until the next blade is positioned for measurement. Repeat for each blade. If all blade levels are not equal, you can adjust blade levels by the following procedure. To adjust a blade tip down, insert a washer (not supplied) between the blade and blade holder at the screw closest to the motor. To adjust a blade tip up, insert washer (not supplied) between the blade and blade holder at the two screws farthest from the motor. Reverse the position of the washer if blades mount from top of blade.</li><li>6. If blade wobble is still noticeable, interchanging two adjacent (side by side) blades can redistribute the weight and possibly result in smoother operation.</li></ol>
4. If light does not work:	<ol style="list-style-type: none"><li>1. Check blue wire from fan to make sure it is connected to hot wire from house.</li><li>2. Check for loose or disconnected wires in fan switch housing.</li><li>3. Check for loose or disconnected wires in light kit.</li><li>4. Check for faulty light bulbs.</li></ol>

**WARNING: Over lamping the fan will result in the fan lights shutting down until the proper wattage of bulbs are installed. Reset the lights by turning off the wall switch, breaker, or by remote. Replace bulbs with the correct wattage bulbs, turn the power on.**

**CAUTION: Make sure main power is turned off before entering switch housing.**

Apr.2013

May.2013 CUL requirement

Aug.2013 dual mount

Jul.2014 logo on canopy