



**AIREMAX**

## **Portable Air-conditioner**

**APO108C**

**Use and Care Manual**

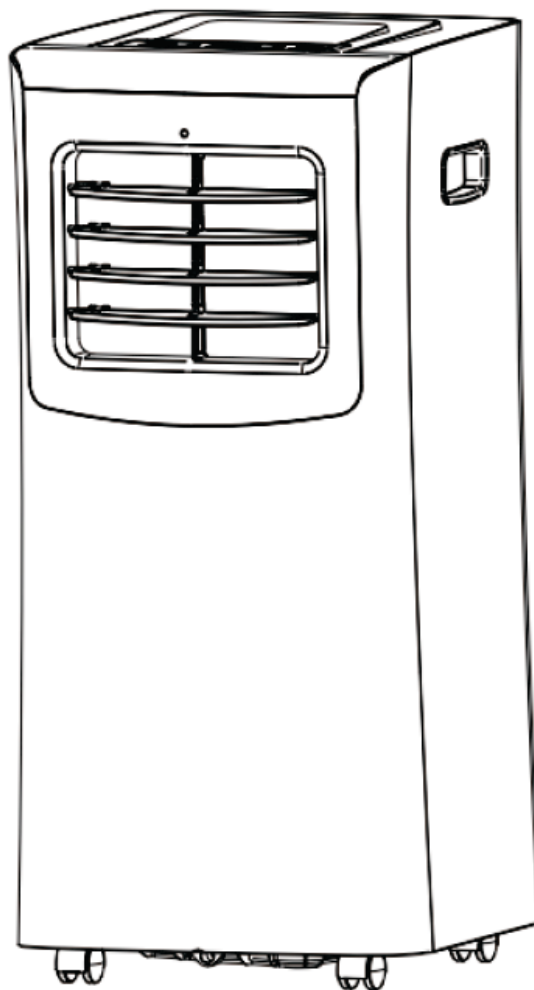

Thank you very much for selecting this new model of Portable Air Conditioner, please read this Use and Care Manual carefully before installing and using this appliance. Please keep this Use and Care Manual properly for future reference.

# Content

Safety Instructions.....	2
Functions and Technical Specification .....	3
Features and Identification of Parts.....	3
Operation and Settings.....	4
Multiple Protection Functions .....	8
Handling and Transportation .....	9
Installation & Adjustment .....	9
Drainage Instruction .....	12
Maintenance and Service .....	13
End of Season Storage .....	14
Troubleshooting .....	15
Appendix.....	16
Warranty terms and conditions .....	17

## Safety Instruction

1. If you have any questions regarding to the following instructions, please contact a qualified electrician.
2. The unit must be installed in accordance with national wiring regulations. Check available power supply and resolve any wiring problems before installation and operation of this unit - voltage standard: 115V/60Hz.
3. For your safety and protection, this unit will be grounded through the power cord plug when plugging into a matching wall outlet. If you are not sure whether the wall outlet at your home are properly grounded, please consult an electrician. If supply cord is damaged, it must be replaced by the manufacturer, its service agent or similarly qualified person in order to avoid any hazards.
4. This appliance is not intended for people (including children) with reduced physical, sensory or mental capabilities, or lack of experience and knowledge, unless they have been given supervision or instruction concerning use of the appliance by a person responsible for their safety. Young children should be supervised to ensure that they do not play with the appliance.



### **WARNING:**

To reduce the risk of fire, electrical shock or injury when using your air conditioner, follow up these basic precautions:

- ※ Indoor use only, it is prohibited to use this unit outdoors or in humid environment such as bathroom etc.
- ※ Do not remove ground prong.
- ※ Do not use an adapter.
- ※ Do not use an extension code.
- ※ Never share the power outlet with other appliances.
- ※ Never connect or disconnect the power plug with wet hands to avoid electric shocks.
- ※ Never turn off the unit by unplugging.
- ※ Unplug air conditioner before servicing.
- ※ Never dismantle, repair or modify the unit without authorization to avoid body injury or property damage, be sure it repaired by manufacturer or professionals.
- ※ Never put any objects into the unit.
- ※ Never cover or obstruct air inlet or outlet to prevent overheating.
- ※ Never hit or shake the unit to prevent damage.
- ※ Never spray water or place the unit near water to prevent electric shocks.
- ※ Never place the unit near gas appliances, fire or flammable liquids.
- ※ Move and install the unit by two or more people.
- ※ Keep children away from the unit.
- ※ This appliance can be used by children aged from 8 years and above and persons with reduced physical, sensory or mental capabilities or lack of experience and knowledge if they have been given supervision or instruction concerning use of the appliance in a safe way and understand the hazards involved. Children shall not play with the appliance. Cleaning and user maintenance shall not be made by children without supervision.

## Cautions

- ※ Keep the unit at least 1 meter away from TV or radios to avoid electromagnetic interference.
- ※ Do not expose the unit under direct sun light to avoid surface color fading.
- ※ Do not tilt the unit for more than 35 degrees or upside-down while transporting.
- ※ Place the unit on a flat surface and upright with less than 5 degrees inclination.
- ※ The unit operates more efficiently in certain room locations (see Installation and Adjustment)
- ※ Keep the drain hose in good condition without flexure then connect with unit.
- ※ Manually adjust the vertical and horizontal louvers slightly to protect louvers from any damage.
- ※ Empty the condensed drainage pan before putting the unit in storage to prolong the unit lifetime end of the season.
- ※ Do not use chemical solvents (e.g. Benzene, alcohol-glazer) to clean the unit surface, do not scratch or damage the unit.
- ※ Make sure to cut off the power before disassembling or installing the filter.

### Suggestion:

The best ambient temperature for the use of this machine is 17°C - 35°C.

## Functions and Technical Specification

- ※ This unit offers cooling, dry, fan and sleep modes.
- ※ This unit is with two fan-speed level accessible by panel control and remote control.
- ※ Temperature setting range of this unit is 17-30°C (62-86°F) .
- ※ This unit is designed with various protection functions such as 24-hour programmable timer, auto condensate circle, super intelligent temperature sensor and water-full control and warning etc.

## Features and Identification of parts

### 1. Features

- ※ New appearance and compact.
- ※ Both horizontal and vertical louvers can be manually adjusted to enhance cooling performance.
- ※ Integrated design of humanized handle and remote control compartment.
- ※ Simple LED control panel, more visualized.
- ※ Universal plug fixing holes can well protect the power cord.
- ※ High position of exhaust air outlet, easy assembly and exhaust venting quickly.
- ※ 24-hour Timer function, unique on/off reminding music.
- ※ 3-minute re-start delay protection to compressor and other multiple protection functions.
- ※ Unique exhaust hose and fasteners, convenient installation.

## 2. Identification of Parts:

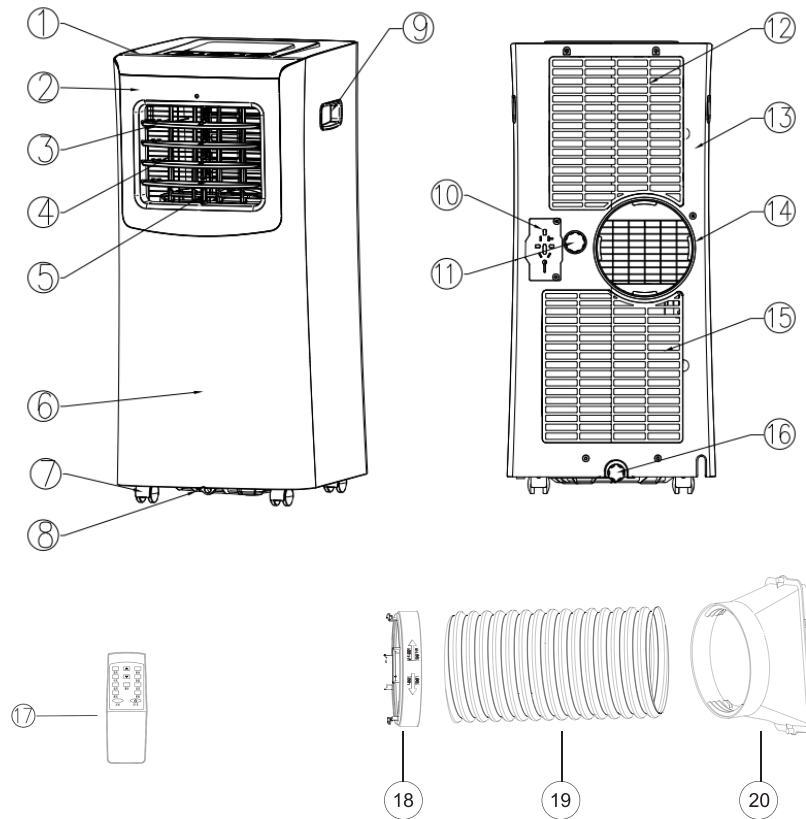













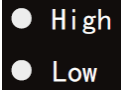

- |                                       |                            |
|---------------------------------------|----------------------------|
| 1. Top panel                          | 11. Upper drain hole       |
| 2. Front panel                        | 12. Upper filter           |
| 3. Horizontal louvers                 | 13. Back shell             |
| 4. Vertical louvers                   | 14. Exhaust hose connector |
| 5. Front shell connector              | 15. Lower filter           |
| 6. Front shell                        | 16. Lower drain hole       |
| 7. Universal wheel                    | 17. Remote control         |
| 8. Chassis                            | 18. Round Connector        |
| 9. Handle                             | 19. Exhaust hose           |
| 10. Universal plug protective sockets | 20. Adapter                |

## Operation and Settings

### 1. Control Panel:

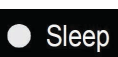

## 2. Control panel list:

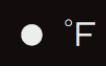
	On/Off button		Mode button		Up button
	Timer button		Fan speed button		Down button
	Timer indicator		Fan speed indicator		Water-full indicator
	Cool mode		Fan mode indicator		Dehumidify mode indicator
	Sleep mode indicator		Power indicator		Celsius temperature indicator
	LED display window		Timer indicator		Fahrenheit temperature indicator

## 3. Control Panel Operation

A. Turn on the unit:

a) Connect the power supply and all indicators on the control panel will light up with reminding music; LED display window will show ambient temperature ranging from 10- 35°C. On/Off button will be in red color, and the unit is standby for operation.

b) Press the On/Off button, the unit turns on with reminding music sounded, On/Off button will in green color, and operate in Cool Mode automatically, temperature set at 24°C, and fan runs at high speed.

B. Select operating mode

Press the Mode button to toggle among the operating options: Cool – Dehum – Fan. The corresponding indicator will illuminate:

C. To Set the Temperature:

The temperature can be set between 17°C and 30° C when the air conditioner is in Cool mode.

D. Fan speed button

The fan speed can be adjusted from Low speed to High speed when the air conditioner is in operation.

NOTE: The fan speed cannot be adjusted when the unit is in Dehum mode.

E. Stand-by

Press On/Off button again, the unit will stop working with reminding music, and On/Off button will be in red color.

### Working principle for each mode and function

1. Cool mode:

- When room temperature is 1°C higher than setting temperature, the compressor and fan will start working.
- When room temperature is 1°C lower than setting temperature, the compressor will stop working and fan keep working at original speed.

- Room temperature can be set within a range of 17-30°C and fan speed can be adjusted to high or low level.
  - On/Off time can be set.
  - E1, E2 & E4 protection (see Troubleshooting).
  - Water-full warning protection.
2. Fan mode:
- Fan runs at set speed, and compressor will not work.
  - Fan speed can be adjusted to high or low level.
  - Room temperature will automatically show on LED display with range 10-35°C.
  - Room temperature can't be adjusted.
  - On/Off time can be set.
3. Dehumidify mode:
- Fan will run at low speed automatically, and the speed can't be adjusted.
  - Room temperature can't be adjusted.
  - Room temperature will automatically show on LED display with range 10-35°C
  - On/Off time can be set.
  - E1, E2 & E4 protection (see Troubleshooting).
  - Water-full warning protection.
4. Sleep mode:
- Under cooling mode, press "Timer" + "Down" buttons together, the unit auto enter into "Sleep" mode.
  - Fan will turn to low speed automatically and can't be adjusted.
  - Set temperature will increase 1°C when unit running in 2 hours, increase 1°C again in another 2-hour working, then keep set temperature unchanged further.
  - Room temperature will automatically show in LED display with range 10-35°C.
  - On/Off time can be set.
  - E1, E2 & E4 protection (see Troubleshooting).
  - Water-full warning protection.
5. Timer Operation
- Press "Timer" button to set automatic OFF time while unit is running, "Timer" will light up.
  - The unit will be off automatically when the set time is off, and "Timer" will be off, room temperature is shown on LED display window.
  - Press "Timer" button to set automatic ON time while unit is off, "Timer" will light up.
  - The unit will turn on automatically and working at original mode when the set time is over, "Timer" will be off, room temperature is shown on LED display window.
  - When press "Timer", "Timer"& "Hr" will light up, LED display window will flash under half second frequency, press "Up" or "Down" buttons within 5 seconds to finish timer setting, set time will flash 5 seconds for confirmation and "Hr" will turn off, then room temperature will be shown on LED display window.
  - Under "Timer" function, press "Timer" once to check time remained. Timer indicator keep light up; press "Timer" twice within 5 seconds to cancel timer, "Timer" will turn off.
  - Only final setting is effective if repeated setting.
  - The time can be adjusted within a range of 1-24 hours, press "Up" or "Down" button to increase or

decrease 1 hour.

- Unit will not change working mode after timer setting. Timer will not stop by other functions.
- Timer will be ineffective if any operation from control panel or remote control to turn on or turn off the unit.

#### Remote Control Operation

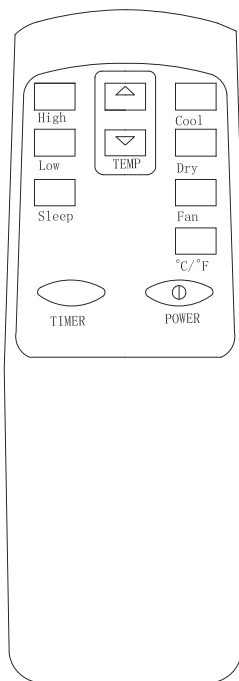

**Power Button:** press this button to start unit when it is energized or stop the unit when it is in operation.

**Timer Button:** press this button to set unit automatic on and off time.

**High Button:** press this button to select high speed of fan running (except dry and sleep modes) Button:

**Low Button:** press this button to select low speed of fan running.

**TEMP UP Button:** press this button to increase temperature or timer setting.

**TEMP Down Button:** press this button decrease temperature or timer setting.

**Cool Button:** press this button to select “Cool” mode.

**Fan Button:** press this button to select “Fan” mode.

**Dry Button:** press this button to select “Dry” or “dehumidifying” mode.

**Sleep Button:** press this button to select “Sleep” function under cooling mode.

#### **Before using your remote, install the AAA batteries into remote control.**

1. Press and glide the battery cover on the back of the remote control, then you can remove the cover.
2. Insert two new alkaline AAA batteries into the battery compartment. Be sure to note the proper polarity.



3. Reattach the battery cover and make sure the locking tab clicks into place.

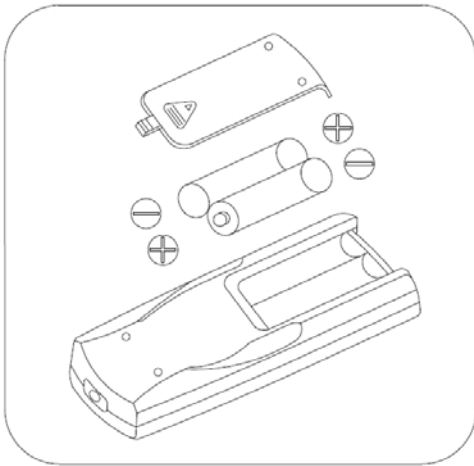

Be sure to note proper polarity of batteries

Notes:

- Use alkaline batteries only. Do not use rechargeable batteries.
- When replace batteries, always replace both batteries with new batteries, do not mix old and new batteries.
- If the air conditioner will not be used for an extended period of time, remove the batteries from the remote control.

### CAUTION

- If the liquid from the batteries gets onto your skin or clothes, wash it well with clean water, do not use the remote control if the batteries have any leakage.
- If you eat the liquid from the batteries, brush your teeth and see doctor. The chemicals in batteries could cause burns or other health hazards.

## Multiple Protection Functions

### 1. Anti-freeze protection function

Compressor, water spraying motor will turn off when compressors running over 10 minutes and tube temperature ( $T_p$ ) is continuously  $\leq 2^{\circ}\text{C}$  for 20 seconds under cooling mode, E4 will show on LED display window, the unit initiates the anti-frost protection and all buttons on control panel (except for power button) are inactive.

Once the tube temperature  $\geq 8^{\circ}\text{C}$ , the protection is relieved to recover into original status, and compressor apply to 3-minute delay protection.

### 2. Water-full safety alarm and shut –off protection function:

Warning sounds when the water volume reached its alarm level in water tank, and unit is automatically stop working, both water-full indicator and “FL” on LED window is flashing. You need to drain the condensate for unit to automatically recover operation. (For more information about how to drain, refer to the “Drainage Instruction” please).

### 3. Delay protection function of compressor

This unit offers restart protection to compressor. Except that the compressor may start immediately when the unit is energized at first time, there is 3-minute start delay after compressor is shut down.

## Handling and Transportation

### 1. Handle and move the unit

Hold the top of the air outlet window in front panel with one hand and the handle at the top of back panel with another hand, then move the unit in upright position.

Note:

- Do not hold the horizontal louvers by hand.
- Make the unit in the upright position whatever handling or moving it.
- Drain the water in the unit completely to prevent water leakage and wet the floor or carpet before handling or moving the unit.
- Take away the remote control before handling or moving the unit

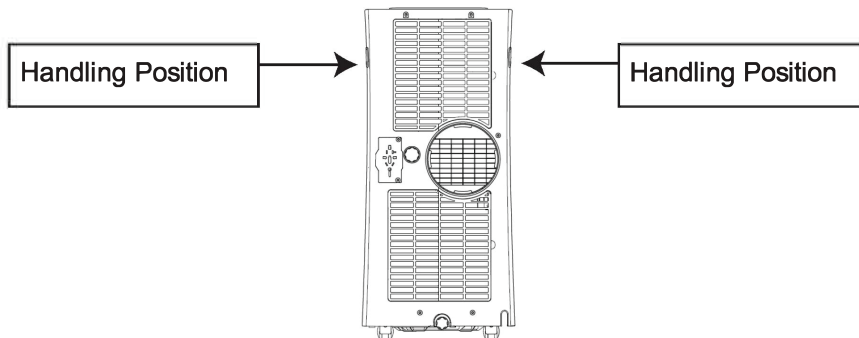

## Installation & Adjustment

### Warning:

- Keep this mobile air-conditioner in upright position at least 2 hours before first installation.
- This air-conditioner may be moved indoors conveniently; keep the unit in upright position while moving it. The air-conditioner shall be placed on flat surface.
- Do not install or operate this air-conditioner in bathroom or other wet environments.

### 1.1 Installation of exhaust hose assembly and its adapter

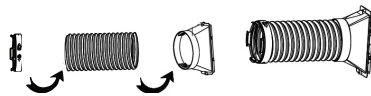

- 1) Take out the exhaust hose assembly and its adapter from plastic bag.
- 2) Extend the exhaust hose at one end, screw the round end of adapter into exhaust hose at anticlockwise direction

Note: Screw adapter into right position, at least 3 laps, to keep good connection of exhaust hose assembly and its adapter

### 1.2 Installation of the exhaust hose assembly into unit

- 1) Determine window seal-plate position, vertical or horizontal direction.
- 2) If window seal-plate will be in horizontal position, the slant panel A of adapter should be upwards.
- 3) If window seal-plate will be in vertical position, and will be at left side of window, the slant panel A of adapter

should be at right direction.

- 4) If window seal-plate will be in vertical position, and will be at right side of window, the slant panel A of adapter should be at left direction.

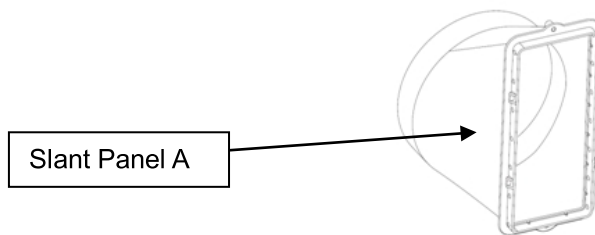

1. Take two ends of exhaust hose and its adapter assembly
2. Put front end of exhaust hose assembly onto jugged position of exhaust outlet of back panel.

Remark: Keep the right direction of slant side A of adapter, for ease installation of window seal-plate.

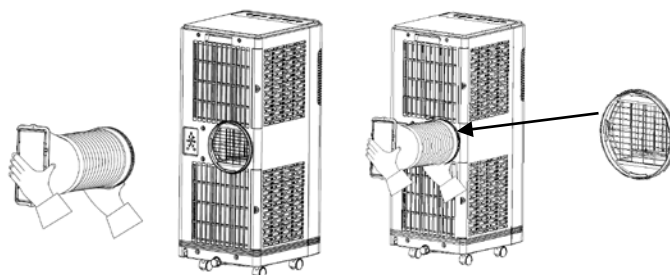

3. Hold the unit by one hand, carry the exhaust hose assembly with another hand and push it into unit gently, for good lock of two parts.

**Remarks:**

- Keep the right direction of slant side A of adapter, for ease installation of window seal-plate.
- Keep exhaust hose assembly be strongly locked by fasteners in exhaust outlet to avoid its fall off.

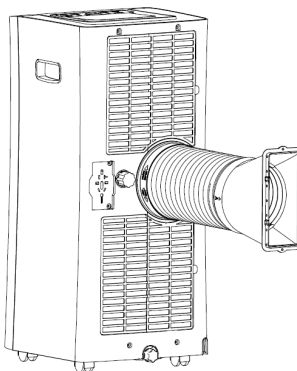

**1.3 Installation of window seal-plate**

- 1) Open the window in half, put the seal-plate into window, determine in vertical or horizontal position according to window open direction.
- 2) Extend seal plate parts, adjust it to the length of window and fix it with screws then.

**Remarks:**

- Keep two ends of window seal-plate to meet the window edges well, to assure seal effect.
- Fix the screw in good position.

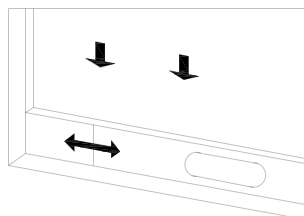
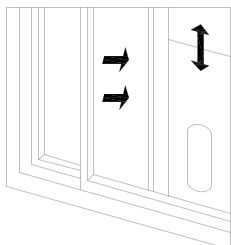

#### 1.4 Installation of the unit

1. Move the unit together with its exhaust hose assembly in front of the window and keep the unit at least 50cm away from the walls or other objects.
2. Install the rectangle end of exhaust hose adapter into the corresponding rectangle hole in window seal-plate assembly, fix it with screw and close the window (as Photo).
  - A. Align the 4 openings on window seal-plate with corresponding 4 openings on exhaust hose adapter and set them together, then slide adapter downwards, to make 2 set of openings locked for 2 parts good connection.
  - B. Lock self-tapping screw  $\phi 4\text{mm}$  into adapter hole.

#### Remarks:

- Slide the adapter downwards and assure the adapter installed in good position.
- Lock the screw tightly to avoid fall off.
- Exhaust hose can't be bent or with flexure higher than  $45^\circ$ , in order to keep good ventilation of exhaust hose.

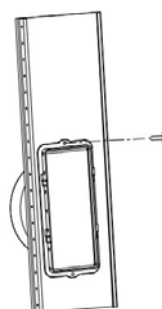
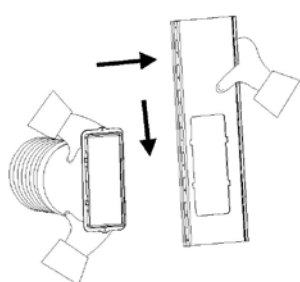

#### Important notes:

The exhaust hose is 280mm-1500mm long and which is determined by the specification of the air-conditioner (s). Do not use prolonged the hose or replace it with other different hoses as this may affect the functions of the air-conditioner. The exhaust hose must be smooth or it may lead air-conditioner overheat and trip because exhaust hose is obstructed.

## Drainage Instruction

This portable air conditioner has two drain ports - an upper drain port and a lower drain port. It also has two drainage methods that can be used - manual drainage and continuous drainage.

### 1. Manual drain:

This unit is designed with a highly efficient self-evaporative system and it is suggested to use manual drainage in cooling mode. Condensate will recycle in the unit to cool the condenser and enhance cooling performance. However in extreme humidity, the water tank in the chassis will fill up and “FL” will show on the LED display. When this happens the water tank needs to be drained manually from lower drain port.

- Put a shallow tray below the lower drain port at the back of the unit.
- Screw off the drain port cover and then remove the water stopper to allow water flow into the tray.
- After water has stopped flowing, plug in the water stopper back in and screw the drain port cover back onto the drain port tightly.

### NOTE:

- To avoid leaks, if it is necessary to move the unit always turn off the unit and make sure it is drained properly before moving.
- If the drain port cover or water stopper are damaged during use, they should be replaced with new ones.
- Tilt the unit slightly backwards when draining.
- If the shallow tray has insufficient capacity to hold all the water that is draining, block the drain port with the water stopper before the tray is full, empty the tray, and then restart the draining process.
- The water stopper and drain port cover must be fitted properly to avoid leakages.

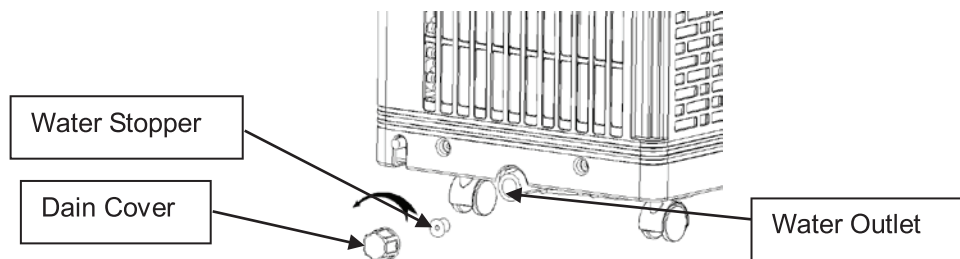

### 2. Continuous drain:

- 1) Screw off the drain cover and unplug the water stopper.
- 2) Connect drain hose
- 3) Pull the drain hose to bathroom or outdoor.

### Notes:

- Drain hose must be installed before unit starts working.

- When unit is operating in cooling mode, to ensure enough water to recycle in the unit to cool condenser and enhance cooling performance, so it is not suggested to use continuous drainage
- Put the drain hose in an inaccessible place, not higher than drainage hole and keep drain hose straight without any flexure.
- Keep the drain cover and its stopper properly installed when continuous drainage is adopted.

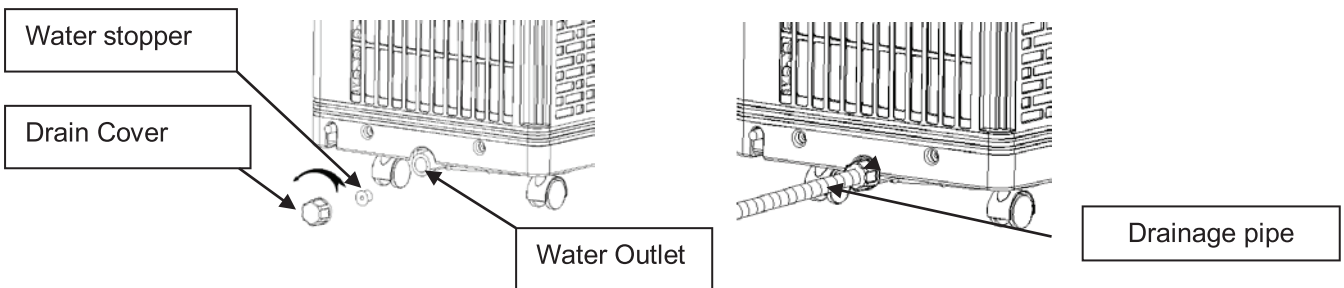

## Maintenance and Service

**Turn off the unit and pull out the plug before maintain or send the unit to service center.**

### 1. Surface cleaning

Clean the unit surface with wet and soft cloth, but do not use chemical solvents such as alcohol and gasoline to avoid any damage to unit.

### 2. Filter cleaning

Clean the filter every two weeks, otherwise it would influence the unit performance if filter clogged with dust.

#### 2.1 How to clean filter

- Grip the filter handle and take it out gently in correct direction shown by the arrow.
- Take out filters of back panel at first then side panel.

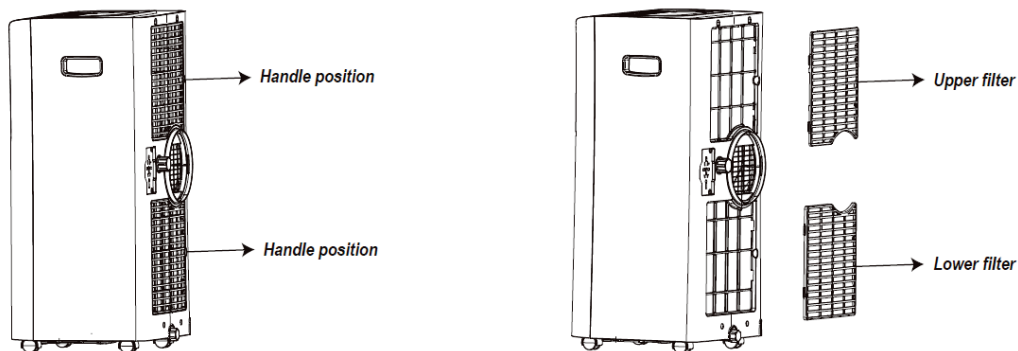

- Clean the filters gently in warm water (about 40°C) mixed with detergent, and dry in the shade
- Use even force to take out the filter to avoid any twist or damage to filter.

#### Notes:

- Do not squash the mesh.
- Do not hit the mesh with sharp objects or brush.

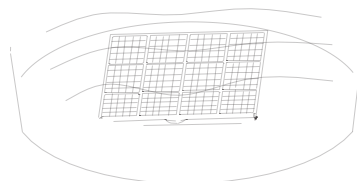

## 2.2 Installation of the filter

Special note: Be sure to install the filters to side panel at first then the filter into back panel.

1. Aim the end of the filter toward slot then push filter in even force gently into slot.

Notes:

- Install the filter with opposite direction of removal.
  - Install the filter into place gently to avoid any damage.
2. Clean of handle position and remote control storage area.
    - 1) Take out the remote control
    - 2) Clean the handle position and remote control storage area with wet and soft cloth.

Note: Do not drip water into the unit.

## End of Season Storage

1. Screw off the drain cover, and then pull out the stopper to drain water completely.

Note: the tilt angle of the unit must be  $\leq 30^\circ$ .

2. Keep the unit running in fan mode half day to dry inside of unit completely to prevent from going mouldy.
3. Turn off the unit, pull out plug then wrap the power cord around the wire-winding pillar, insert the plug into the universal fixing hole at the back panel of the unit, install the water plug and drain cap.
4. Remove the heat exhaust hose assembly, clean and keep it properly.

Notes:

- Hold the exhaust hose assembly with both hands when removal.
  - Push the fasteners aside on exhaust air outlet using your thumbs, then pull out exhaust hose assembly.
5. Pack the air-conditioner properly with soft plastic bag and put it in dry place with appropriate dust-proof measures and keep the unit away from children.
  6. Take out the batteries from the remote control and keep it properly.

Note: Assure the unit is stored in a dry place. All accessories of the unit shall be properly protected together.

## Troubleshooting

Please check the unit and suggestions below before asking for professional service, but never dismantle or repair the unit by yourself, it may cause harm to you and your property.

Trouble	Cause	Remedy
The unit fails to start up	Power supply failure	Connect the unit to a live socket and turn it on.
	Water-full and its indicator lighting up	Drain the water stored in the unit.
	Ambient temperature too low or too high	It is recommended to use this unit between 10-35°C (50-95°F.)
	The room temperature is lower than the set temperature in cooling mode.	Change the set temperature
Bad cooling effects	There is direct sunlight	Close the curtain
	The doors and windows are open, the room is crowded or there are other heat sources	Close the door and window, remove other heat sources, and add new air-conditioners
	Dirty filter	Clean or replace the filter.
	Air inlet or air outlet clogged	Remove the obstruction
High noise level	The unit is being placed at uneven surface.	Put the unit at a flat and firm place (may reduce noise)
The compressor does not work	Initiation of overheat protection.	Wait until the temperature decrease, the unit will re-start automatically
The remote control does not work	Too long distance	Bring the remote control close to the air-conditioner and ensure aims at signal receptor on unit.
	The remote control didn't aim at signal receptor on unit.	
	The batteries have no electricity	Replace the batteries
LED displays error code "E1"	Tube temperature sensor failure	Check the tube temperature sensor and related circuits
LED displays error code "E2"	Room temperature sensor failure	Check the room temperature sensor and related circuits
LED displays error code "E4"	Anti-freeze protection	Restore the functions automatically once anti-freeze protection is over.
Water-full indicator lights	The water in chassis is full	Drain the water and re-start the unit



## Appendix

Schematic diagram of the air conditioner

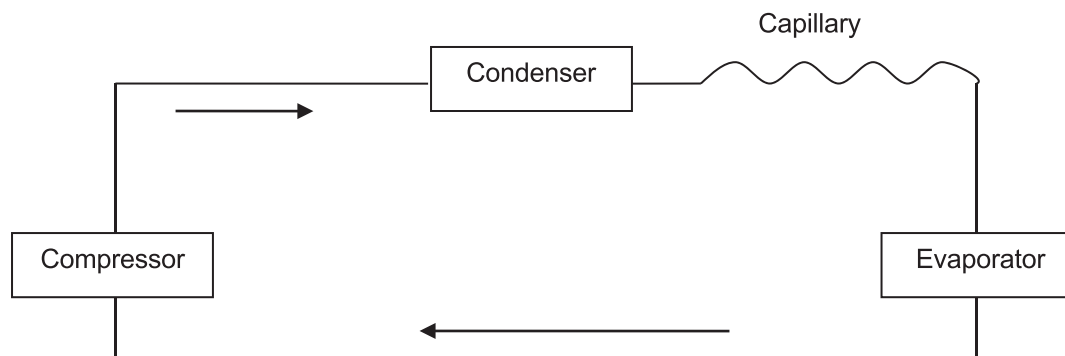

For specific technical parameters of the model, refer to rating label on the product.



Correct Disposal of this product

This marking indicates that the product should not be disposed with other household wastes throughout the world. To prevent possible harm to the environment or human health from uncontrolled waste disposal, recycle it responsibly to promote the sustainable reuse of material resources. To return your used device, please use the return and collection systems or contact the retailer where the product was purchased. They can take this product for environmental safe recycling.



## Warranty Terms & Conditions

**AIREMAX**

Question about your product? We are here to help.

Visit us at: [www.airemaxusa.com](http://www.airemaxusa.com)

Or call our Customer service hot-line: **1- 855 475 9647**

### **PRODUCT WARRANTY INFORMATION**

**Under normal operations, the product will guarantee a 1-year full warranty provided by AIREMAX (effective from the date of purchase).**

In Order to Make a Warranty Claim During the First 90 Days from the Date of Original Purchase:

1. Properly pack your unit. We recommend using the original carton and packing materials.
2. Include in the package a copy of the sales receipt or other evidence of date of original purchase. Also print your name and address and a description of the defect.
3. Pictures may be required for some returns to ensure an item is not damaged prior to its return.

Customer should always follow the operating instructions. The warranty does not apply to:

1. Labor costs for on-site installation, check-up, repair, replacement of parts and other transportation costs.
2. Damages caused by accidents of any kind (including material transfer and others)
3. Operating failures resulting from applying incorrect voltage, improper usage, and unauthorized installations or repairs.

This warranty is invalid if:

1. The product is used for any commercial or or industrial purposes.
2. The product is repaired or modified by unauthorized personnel, or unauthorized parts are installed.
3. The serial No. is modified, damaged, or removed from the product.

### **⚠ WARNING**

**Manufacturer and seller expressly disclaim any and all liability for personal injury, property damage or loss, whether direct, indirect, or incidental, resulting from the incorrect attachment, improper use, inadequate maintenance, or neglect of this product.**