

Cabrini Media Fireplace

FA934800TX -Black

FA934900TX -white

Assembly Instructions



Southern
ENTERPRISES





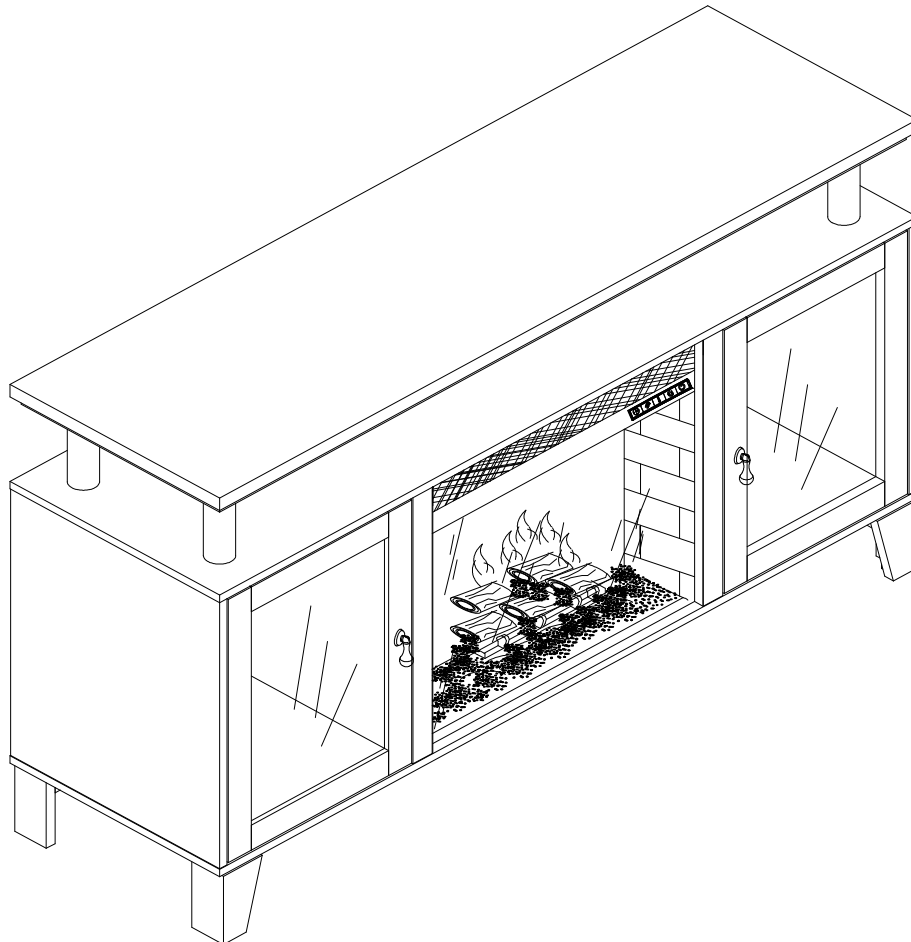





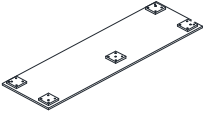

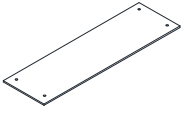
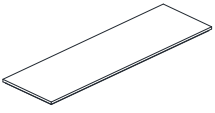
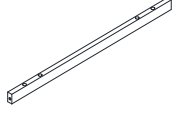
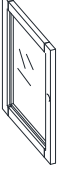
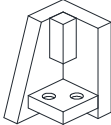
For assistance with assembly, contact:
Southern Enterprises Inc.
Customer Service 1-800-633-5096
service@seidal.com
www.seidal.com



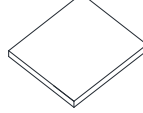

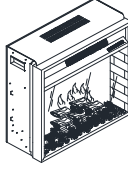

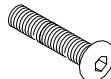
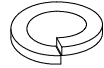

PO#

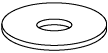

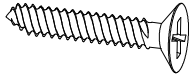
Cabrini Media Fireplace- Black Parts List

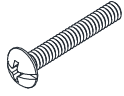
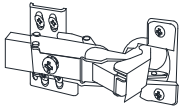
Please check packaging for all parts and hardware before discarding. Unpack and lay parts on clean, padded surface like carpet or blanket. Check that you have all parts indicated. Call customer service if hardware is missing. Before beginning assembly, carefully study the diagrams below and sort your hardware according to the pictures. Using the incorrect hardware will cause damage.

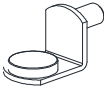
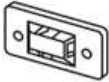
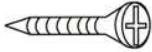
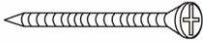
<p>(1)  Quantity of 1</p> <p>Bottom Panel</p>	<p>(2)  Quantity of 2</p> <p>Side Panel (L/R)</p>	<p>(3)  Quantity Of 2</p> <p>Partition Panel (L/R)</p>
<p>(4)  Quantity of 1</p> <p>Lower Top Panel</p>	<p>(5)  Quantity of 1</p> <p>Top Panel</p>	<p>(6)  Quantity of 1</p> <p>Upper Crossbar</p>
<p>(7)  Quantity of 2</p> <p>Door Frame (L/R)</p>	<p>(8)  Quantity of 4</p> <p>Leg(L/R)</p>	<p>(9)  Quantity of 1</p> <p>Support Leg</p>
<p>(10)  Quantity of 4</p> <p>Metal Tube</p>	<p>(11)  Quantity of 2</p> <p>Back Panel(L/R)</p>	<p>(12)  Quantity of 2</p> <p>Adjustable Shelf</p>
<p>(13)  Quantity of 1</p> <p>Wood Holder</p>	<p>(14)  Quantity of 1</p> <p>Firebox (Sold Separately)</p>	
<p>A  Quantity of 16</p> <p>Cam Bolt</p>	<p>B  Quantity of 20</p> <p>Wood Dowel</p>	<p>C  Quantity of 16</p> <p>Cam Lock</p>
<p>D  Quantity of 16</p> <p>Plastic Cover</p>	<p>E  Quantity of 12</p> <p>Long Bolt $\varnothing 1/4'' \times 1-3/8''$</p>	<p>F  Quantity of 12</p> <p>Spring Washer</p>

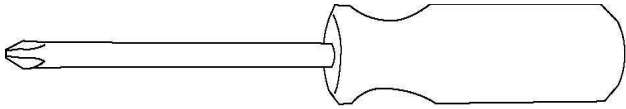
<p>G Quantity of 12</p>  <p>Flat Washer</p>	<p>H Quantity Of 28</p>  <p>Ø3*12mm Screw For Back</p>	<p>I Quantity of 4</p>  <p>Ø5/16"*1"L Long Flat Head Screw</p>
<p>J Quantity of 1</p>  <p>Allen Wrench</p>	<p>K Quantity Of 2</p>  <p>Knob</p>	<p>L Quantity Of 2</p>  <p>Ø5/32"*7/8"L Long Bolt</p>
<p>M Quantity of 4</p>  <p>Hinge</p>	<p>N Quantity of 24</p>  <p>Ø5/32"*5/8"L Short Flat Head Screw</p>	<p>O Quantity of 8</p>  <p>Shelf Holder</p>
<p>P Quantity Of 4</p>  <p>Bracket</p>	<p>Q Quantity Of 4</p>  <p>3.5mm X 15 Mm Screw For Bracket</p>	<p>R Quantity Of 4</p>  <p>7mm X 38mm Screw For Wall</p>
<p>S Quantity Of 2</p>  <p>Plastic Strap</p>	<p>T Quantity Of 4</p>  <p>Plastic Anchor</p>	
<p>Care and Cleaning Instructions: Before using, wipe with a clean, dry cloth. Periodically apply furniture wax to renew the finish . Avoid rubbing or scratching the surface with rough or abrasive objects.</p>		<p>For replacement parts or questions, please call customer service at 1-800-633-5096.</p>
<p>Assembly Tool Required No.2 Phillips Screwdriver (Not Included)</p>		

Cabrini Media Fireplace- Black Assembly Instructions

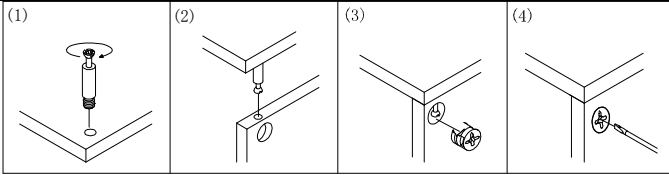

"Please do not over tighten cam bolts,
stop when you feel them tighten"

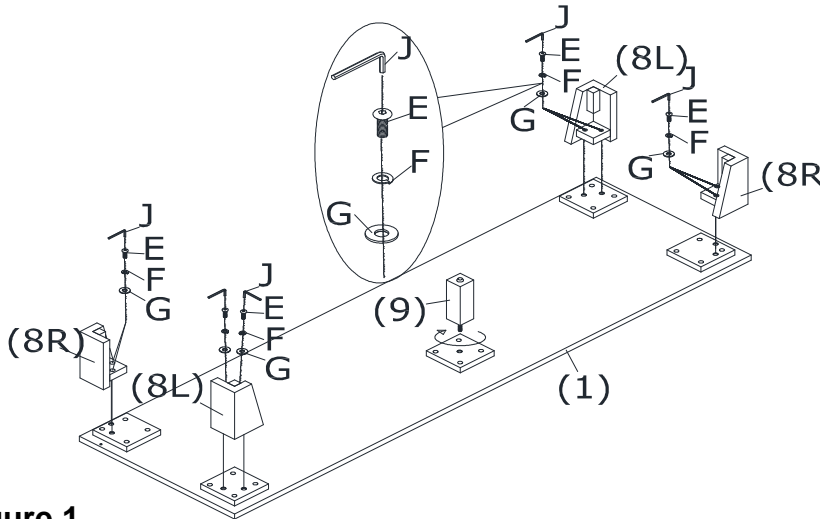

Figure 1

Attach legs (8) to bottom panel (1) using long bolts (E) through spring washers (F) and flat washers (G).

Tighten long bolts (E) with Allen wrench (J).

Attach support leg (9) to the bottom panel (1) rotating support leg (9) clockwise until the tight.

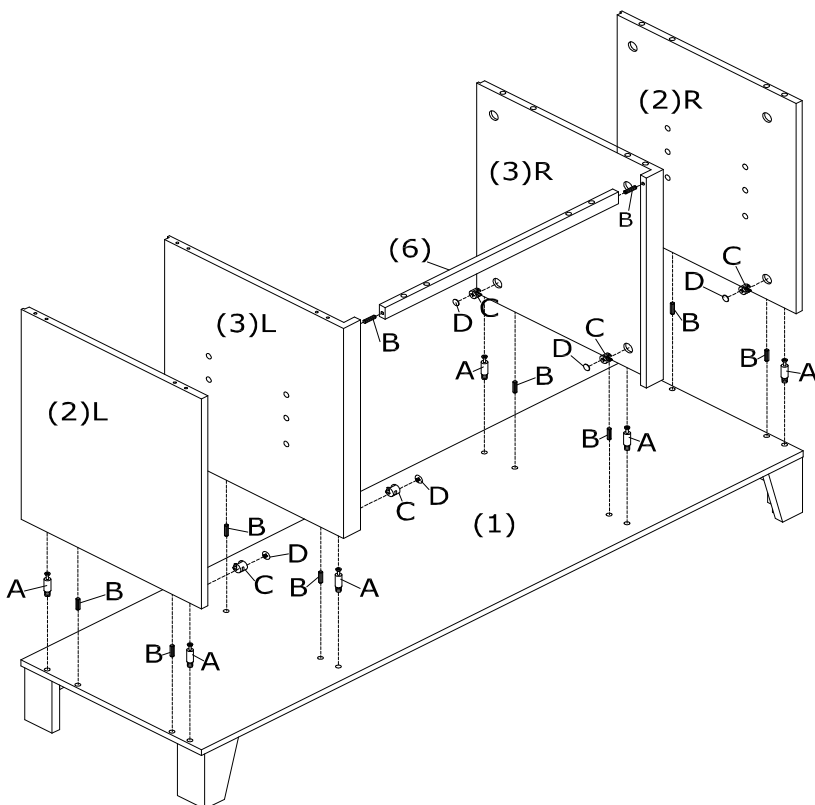

Figure 2

Insert cam locks (C) into holes on partition panels (3L/3R) and side panels (2L/2R).

Screw cam bolts (A) into holes on bottom panel (1). Insert wood dowels (B) to connect upper crossbar to partition panels (3L/3R). Attach side panels (2L/2R) and partition panels (3L/3R) to bottom panel (1) by inserting wood dowels (B) and cam bolts (A) into corresponding holes until panels meet.

Tighten by rotating cam locks (C) clockwise with Phillips screwdriver.

Cover cam lock holes with plastic covers (D).

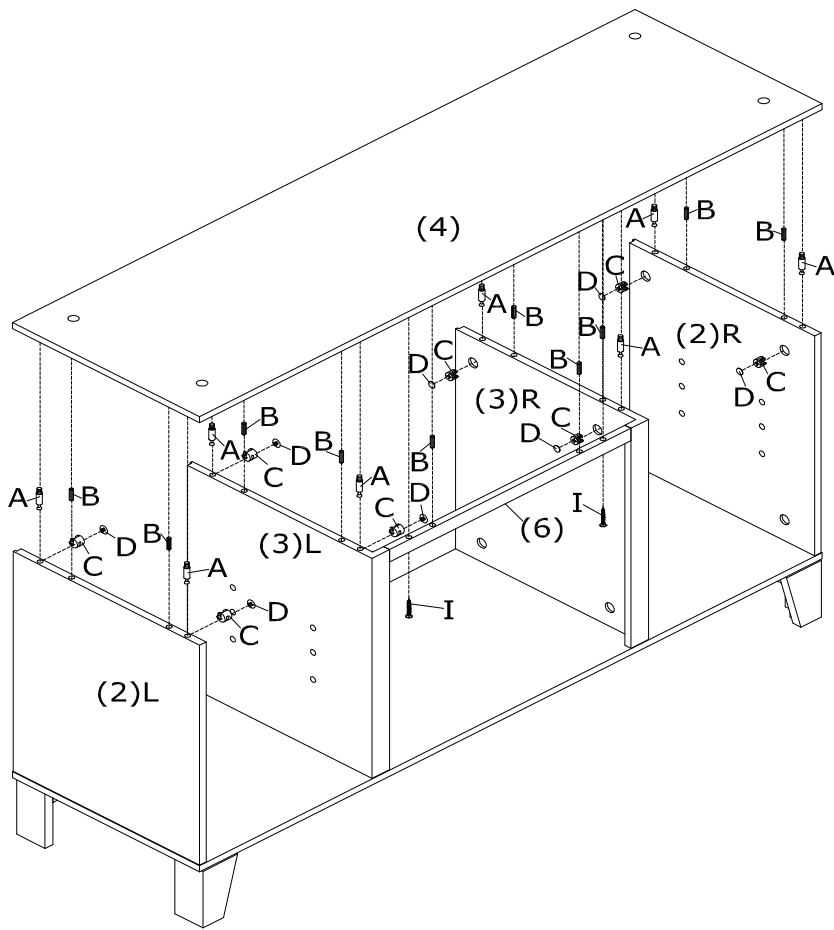

Figure 3

Insert cam locks (C) into holes on assembled unit. Screw cam bolts (A) into holes on lower top panel (4). Attach lower top panel (4) to assembled unit by inserting wood dowels (B) and cam bolts (A) into corresponding holes until panels meet.

Tighten by rotating cam locks (C) clockwise with Phillips screwdriver.

Use long flat head screw (I) to connect upper crossbar (6) to lower top panel (4). Tighten screws (I) with Phillip screwdriver.

Cover cam lock holes with plastic covers (D).

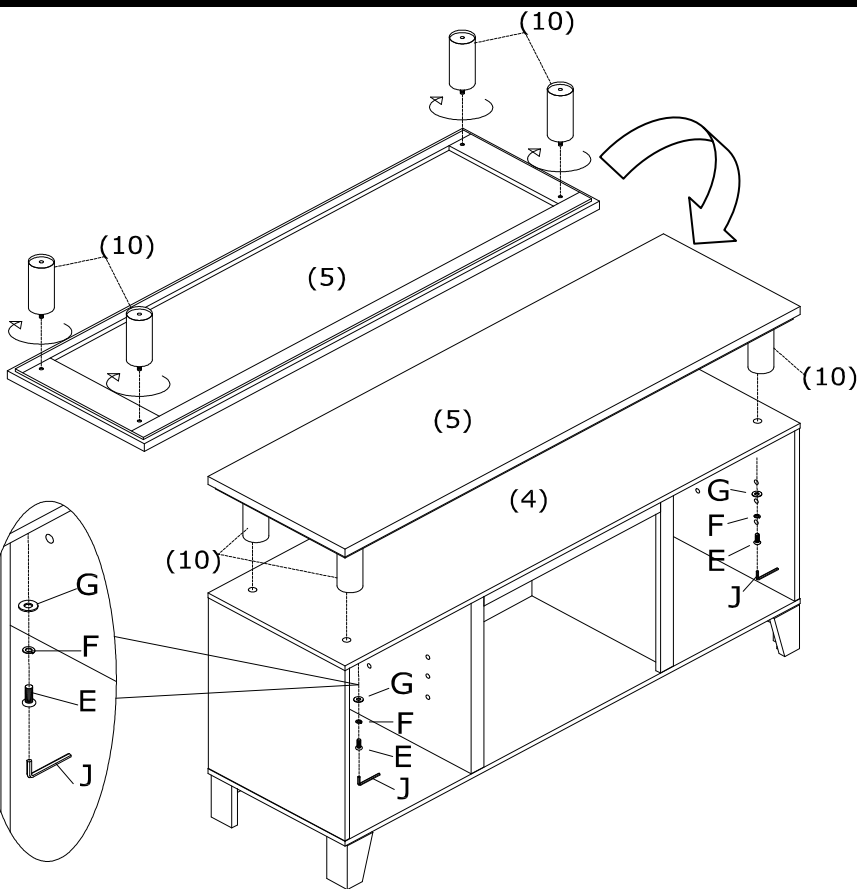

Figure 4

Attach metal tubes (10) to the top panel (5). Rotate metal tubes (10) clockwise until they tighten.

Then use long bolts (E) through spring washers (F) and flat washers (G) to connect lower top panel (4) to metal tubes (10).

Tighten long bolts (E) with Allen wrench (J).

Insert back panels (11L / 11R) into grooves in the back of assembled unit.

Tighten screws (H) with Phillips screwdriver.

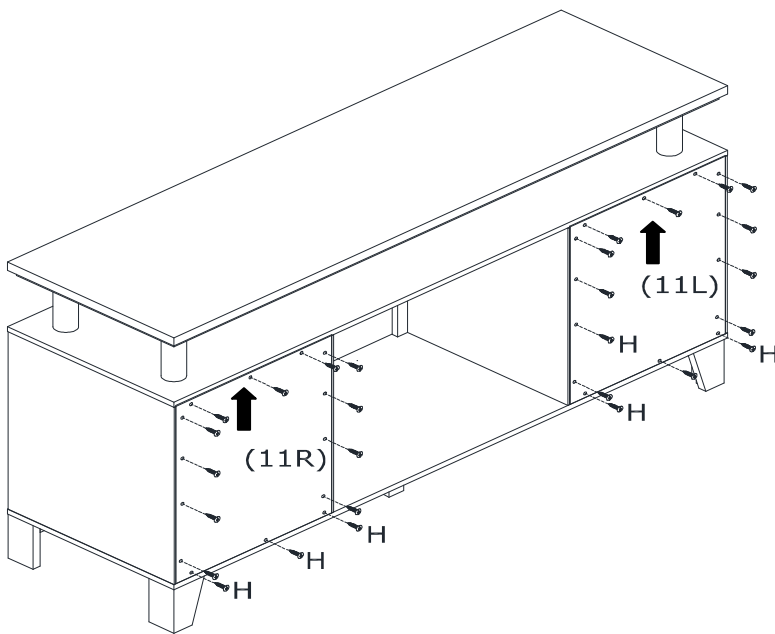

Figure 5

To achieve uniform clearance around the door, you may need to adjust the door by tightening or loosening the two screws on the hinge itself.

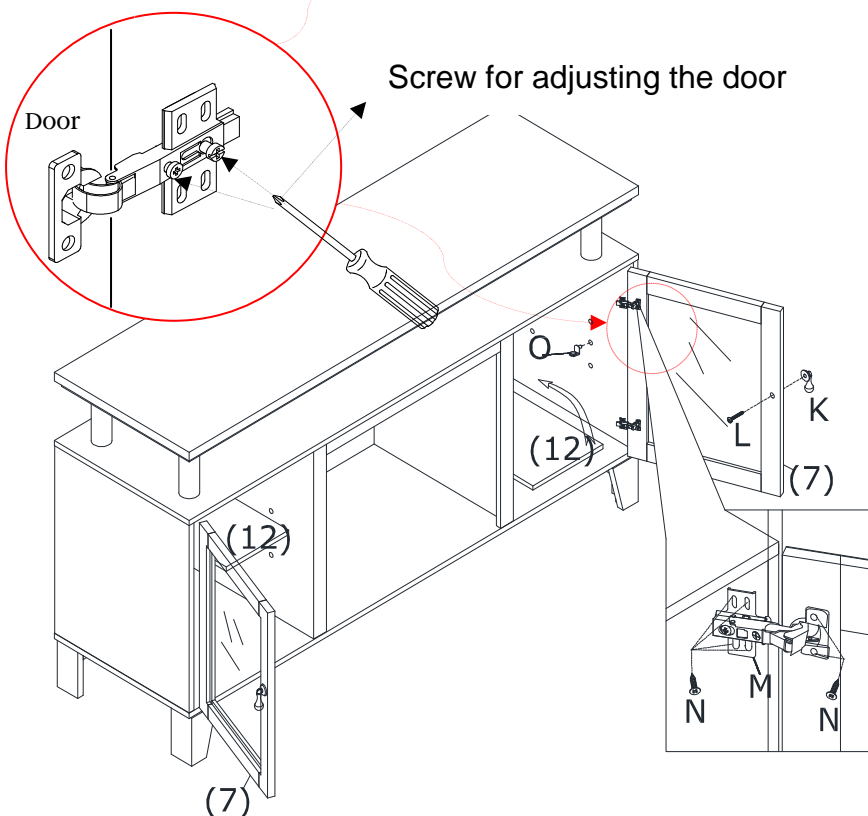

Figure 6

Use short flat head screws (N) to connect hinges (M) to door frames (7) and left/right side panels.

Tighten screws (N) with Phillips screwdriver.

Second, use long bolts (L) to connect knobs (K) to door frames (7).

Tighten long bolts (L) with Phillips screwdriver.

Insert shelf holders (O) into holes on side panels (2L/2R) and partition panels (3L/3R).

Finally, place adjustable shelves (12) onto the shelf holder (O).

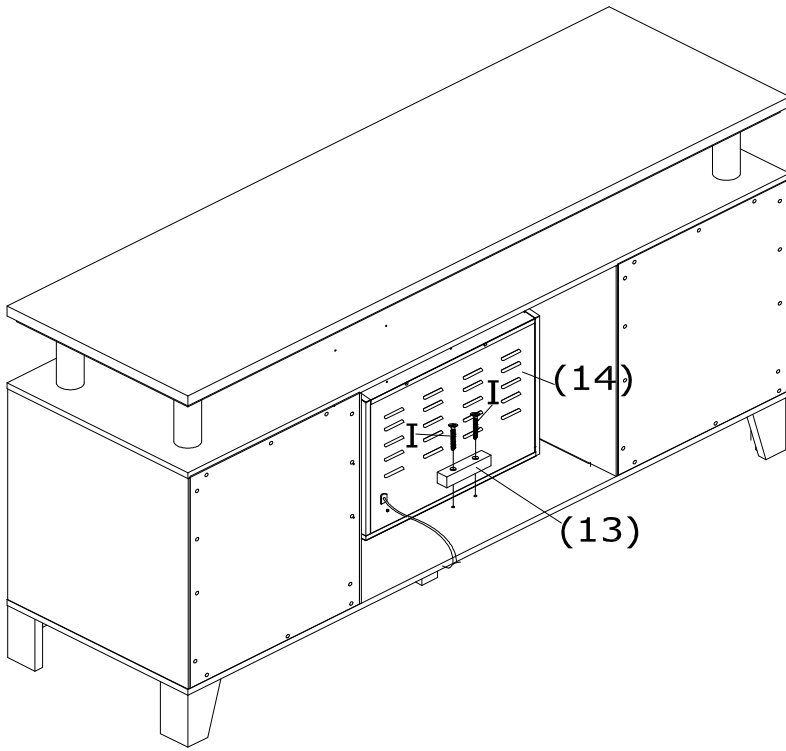

Figure 7

Push firebox (14) into the back of the unit and insert long flat head screws (I) through wood holder (13) to lock tightly.

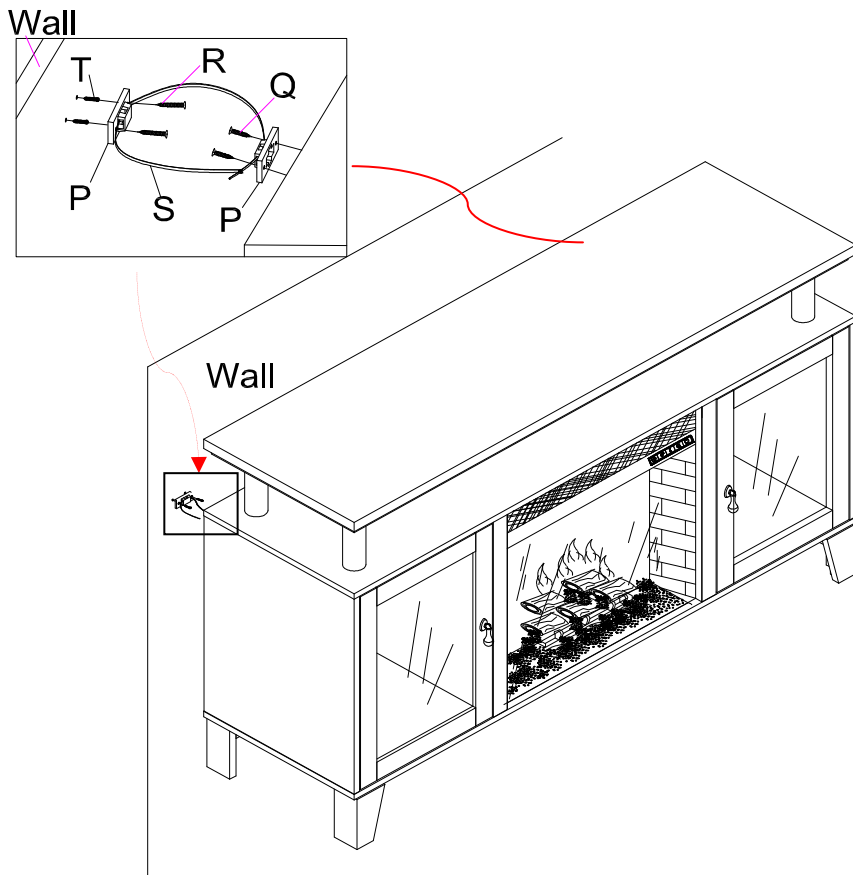

Figure 8

Use screws (Q) to connect brackets (P) to lower top back (4) as shown.

Tighten screws (Q) with Phillips screwdriver.

Drill 1/4 inch pilot holes in near proximity of the brackets (P) attached to the lower top back (4) and tap the plastic anchor (T) into wall.

Use screws (R) to connect brackets (P) to plastic anchors (T) on the wall.

Tighten screws (R) with Phillips screwdriver.

Move this item close to the fastened wall brackets (P) and tie in both brackets (P) with plastic straps (S) as shown in diagram.

Now your fireplace is ready to use.

Parts Replacement Form

Customer Information

Name _____

Address _____

City/State/Zip Code _____

Phone Number _____

Please indicate where you purchased this item: Store/Website/Catalog

Please indicate color/size/style number:

Style No	Parts Letter	Parts Description	Quantity Needed
_____	_____	_____	_____
_____	_____	_____	_____
_____	_____	_____	_____

Please immediately examine this product carefully. Any request for missing parts or damage replacement must be received within 90 days of your receipt of the product. Replacement, if available, will be honored within this time frame. Parts will not be available for items arriving fully assembled. We do not recommend modifying product(s) and we are not responsible for any damages due to product modification(s). If damages or missing parts are not reported within 90 days of your receipt, we are under no obligation to provide parts or replacement merchandise.

Please contact Southern Enterprises at 800-633-5096 or in Dallas 972-869-0111/ 9am – 4pm Mon-Fri Central time if you have product issues or email us at service@seidal.com. Please ask for customer service representative for issues involving damages or replacement parts. Please ask for technical assistance representative for any issues with product and assembly/construction.

Please contact the retailer that you purchased from for returns.



Southern
ENTERPRISES

Customer Service 1-800-633-5096
service@seidal.com
Southern Enterprises, Inc.
600 Freeport Parkway, Suite 200
Coppell, Texas 75019



CAUTION

The top shelf is intended for a flat screen television with a maximum overall width of 48" and supports up to 85 lb.

The top shelf is NOT INTENDED for tube televisions.

Open center shelf should not be loaded with more than 30 lb.

Enclosed side shelves should not be loaded with more than 15 lb/shelf

DO NOT EXCEED RECOMMENDED LOAD. Use with products heavier than the maximum sizes and weights indicated may result in instability causing possible injury.

This unit contains a permanent warning sticker located on under side of top shelf or inside drawer.

Model:FA934800TX
Cabrini Media Fireplace
Southern Enterprises, Inc
600 Freeport Parkway,
Suite 200 Coppell, Texas, 75019
Manufacture Date: 6/2/2014